

**Canon**

**MULTIMEDIA PROJECTOR**

**WUX450**

**WX520**

**WUX400ST**

**WX450ST**

# User's Manual



**AISYS**  
Aspectual Illumination  
System

**HDMI**™  
HIGH DEFINITION MULTIMEDIA INTERFACE

**PJLink**™

Table of Contents

Safety Instructions

Before Use

**Operation**

Projecting an Image

Useful Functions Available  
During a Presentation

Setting Functions from  
Menus

**Installation and Maintenance**

Installation

Connecting to a Network

Maintenance

**Networked Multi-Projection**

Networked Multi-Projection  
Overview

Operation in Each Mode

Functions in All Modes

**Appendix**

Other Information

Index

**ENG**

# How to Use This Manual

Thank you for purchasing a Canon projector.

The WUX450/WX520/WUX400ST/WX450ST Multimedia Projector (hereinafter referred to as “the projector”) is a high-performance projector that is capable of projecting a high-resolution computer screen and high-quality digital image on a large screen.

## This Manual

This manual combines the user’s manual for WUX450/WX520/WUX400ST/WX450ST Multimedia Projectors. The “Operation” section (P49) describes how to use the projector. The “Installation and Maintenance” section (P123) describes initial setup and regular maintenance. For instructions on software for projection by multiple projectors linked in a local network, refer to the “Networked Multi-Projection (NMPJ)” section (P205). Read this manual thoroughly to make the most of your projector. Installation of the projector should be performed by a qualified technician, if possible. Contact the Canon Customer Support Center for further information. Unless otherwise noted, figures in this manual show the WUX450/WX520.

### Symbols of Button Operations

The projector can be operated using the buttons on the remote control or on the side of the projector. The remote control allows you to operate all functions of the projector.

In this document, the button’s operations are shown as below.

Operation of buttons on side of projector

Remote control button operation

#### Selecting Screen Aspect

Select the correct aspect ratio for the screen which is used.

1 Press the MENU button to display the menu window.



2 Press the [Left] / [Right] buttons to select the [Install settings] tab.

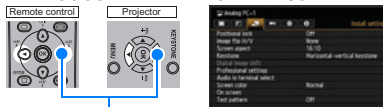

Indicate the buttons to be pressed

### Symbols Used in This Manual

Meanings of the symbols used in this manual are as follows.

⚠ A precaution about operation or restriction is given here.

📄 Indicates supplemental information to note in use.

### **Copyright Notice**

Please note that enlarging or reducing the size of an image for commercial purposes or public presentation may infringe on the legally protected copyright or the copyright holder of the original material.

### **About Trademarks**

- Ethernet is a registered trademark of Xerox Corporation.
- Microsoft, Windows, Windows XP, Windows Vista, Windows 7, Windows 8 and Aero are registered trademarks or trademarks of Microsoft Corporation in the United States and / or other countries.
- Mac, Mac OS and Macintosh are trademarks of Apple Inc., registered in the United States and / or other countries.
- HDMI, the HDMI logo and High-Definition Multimedia Interface are trademarks or registered trademarks of HDMI Licensing, LLC.
- PjLink is a registered trademark, or an application has been submitted for trademark, in Japan, the United States and / or other countries or regions.
- AMX is a trademark of AMX Corporation.
- Crestron®, Crestron RoomView®, and Crestron Connected™ are registered trademarks of Crestron Electronics, Inc.

# Projector Highlights

## Minimal Space Needed for Installation

Compact body (337 x 134 x 370 mm / 13.3 x 5.3 x 14.6 in (W x H x D) (WUX450/WX520) or 337 x 134 x 415 mm / 13.3 x 5.3 x 16.3 in (W x H x D) (WUX400ST/WX450ST)) can be installed with minimal space requirements. (P298)

## High-Resolution LCOS Projection

Projection at 1920x1200 (WUXGA) for the WUX450/WUX400ST or 1440x900 (WXGA+) for the WX520/WX450ST, thanks to high-resolution reflective liquid crystal (LCOS) panels.

## Split-Screen Display

Side-by-side projection of two input images from devices connected to the projector. (P81)

## Manual Lens Shift, Zoom, and Focus

Manually adjust image position (P58, P134) and focus (P59) as needed.

## Zoom Adjustment to Match Screen Size

The size of the projected image can be adjusted using optical zoom (P57) on the WUX450/WX520 and electronic zoom (P149) on the WUX400ST/WX450ST.

## Close-Range Projection on Large Screens (WUX400ST/WX450ST)

Close-range projection on wide screens is supported, such as projection on 100-inch screens from about 1.2 meters.

## USB File Viewer

Project JPEG images stored on a USB flash. (P79)

## Edge Blending

Blend the overlapping edges of images from multiple projectors to make the overall image more seamless. (P159)

## Displaying Test Pattern

Project a range of test patterns, with no image input needed. (P158)

## Networked Multi-Projection (NMPJ)

Project images from multiple computers via a network connection. (P205)

# Quick Reference Guide

This Quick Reference Guide will help you find functions that make full use of the projector and are useful for producing an attractive presentation, etc.

## Connecting the Projector

Connecting to the Computer ([P137](#) - [P139](#))

Connecting to AV Equipment ([P140](#) - [P142](#))

## Projecting an Image

Starting Projection ([P52](#))

Selecting an Input Signal ([P53](#) - [P54](#))

Projecting Images from Two Sources at Once ([P81](#))

## Adjusting the Image

Adjusting the Image Size and Focus ([P57](#) - [P59](#))

Adjusting Keystone Distortion ([P68](#))

Adjusting Aspect Ratio ([P60](#) - [P67](#))

Eliminating Flickers from Computer Screen and Adjusting Positional Shift ([P89](#), [P90](#))

## Adjusting Colors and Image Quality

Projecting an Image on a Greenboard ([P153](#))

Selecting an Image Mode Suitable for the Projecting Image ([P97](#))

Making Fine Color Adjustments ([P101](#))

Removing Noise ([P103](#))

## Producing a Presentation

Temporarily Blacking Out an Image ([P76](#))

Freezing the Picture ([P76](#))

Adjusting the Volume ([P77](#))

Muting the Sound ([P77](#))

Zooming an Image ([P78](#))

Projecting Images on a USB Flash Drive ([P79](#) - [P80](#))

## Changing the Remote Control Channel ([P114](#))

## Resetting Projector Setting

Canceling the Password ([P117](#))

Initializing the Network Setting ([P175](#))

Restoring Default Menu Settings ([P121](#))

## Miscellaneous Functions

Using Auto Power-Off ([P110](#))

Turning on the Projector by Connecting the Power Cord ([P111](#))

Disabling the Beep During Operation ([P111](#))

Disabling Buttons ([P112](#))

Hiding Guide Messages ([P154](#))

Setting a Password ([P116](#))

Reducing the Lamp Brightness ([P107](#))

Displaying Test Pattern ([P158](#))

Selecting Audio In Terminal ([P153](#))

Combining Images from Multiple Projectors ([P159](#) - [P165](#))

Supplying Images over a Network ([P208](#))

# Table of Contents

<b>How to Use This Manual</b> .....	<b>2</b>
<b>Projector Highlights</b> .....	<b>4</b>
<b>Quick Reference Guide</b> .....	<b>5</b>
<b>Safety Instructions</b> .....	<b>16</b>
<b>Safety Precautions</b> .....	<b>17</b>
<b>CAUTION ON HANGING FROM THE CEILING</b> .....	<b>17</b>
■ <b>READ AND KEEP THIS OWNER'S MANUAL FOR LATER USE.</b> .....	<b>18</b>
<b>AC Power Cord Requirement</b> .....	<b>20</b>
<b>Federal Communication Commission Notice</b> .....	<b>21</b>
<b>Canadian Radio Interference Regulations</b> .....	<b>21</b>
<b>Precautions for Use</b> .....	<b>23</b>
<b>Precautions for Installation</b> .....	<b>24</b>
<b>Precautions on the lamp</b> .....	<b>26</b>
<b>Precautions for the batteries of the remote control</b> .....	<b>27</b>
<b>For Safe Use</b> .....	<b>28</b>
<b>Before Use</b> .....	<b>31</b>
<b>Supplied Accessories</b> .....	<b>32</b>
■ <b>Attaching the Lens Cap (WUX450/WX520)</b> .....	<b>33</b>
<b>Preparing the Remote Control</b> .....	<b>34</b>
■ <b>Installing Remote Control Batteries</b> .....	<b>34</b>
■ <b>Remote Control Operating Range</b> .....	<b>35</b>
■ <b>Using an Optional Wired Remote (RS-RC05)</b> .....	<b>36</b>
<b>Part Names</b> .....	<b>37</b>
<b>Projector (WUX450/WX520)</b> .....	<b>37</b>
■ <b>Front Side</b> .....	<b>37</b>
■ <b>Rear Side</b> .....	<b>37</b>
■ <b>Bottom Side</b> .....	<b>37</b>
<b>Projector (WUX400ST/WX450ST)</b> .....	<b>38</b>
■ <b>Front Side</b> .....	<b>38</b>
■ <b>Rear Side</b> .....	<b>38</b>
■ <b>Bottom Side</b> .....	<b>38</b>
<b>Remote control</b> .....	<b>40</b>
<b>Side Control</b> .....	<b>42</b>
<b>LED indicators</b> .....	<b>42</b>
■ <b>LED Indicator Displays</b> .....	<b>43</b>
<b>Input Terminal</b> .....	<b>44</b>
<b>Lens Shift Control</b> .....	<b>45</b>
<b>Projection Lens</b> .....	<b>45</b>

<b>Open Source Software .....</b>	<b>46</b>
■ Software under the GPL and LGPL .....	46
■ Software under the GNU General Public License Version 2.....	46
<b>Operation.....</b>	<b>49</b>
<b>Projecting an Image.....</b>	<b>51</b>
<b>Step 1 Turn the Projector On .....</b>	<b>52</b>
<b>Step 2 Select an Input Signal.....</b>	<b>53</b>
Types of Input Signals.....	53
Selecting an Input Signal .....	54
<b>Step 3 Adjust the Image .....</b>	<b>55</b>
<b>Setting the Display Resolution of the Computer .....</b>	<b>55</b>
■ Windows 8.....	55
■ Windows 7.....	55
■ Windows Vista.....	56
■ Windows XP.....	56
■ Mac OS X.....	56
<b>Auto PC Adjustment .....</b>	<b>57</b>
■ Performing the Auto PC Function .....	57
<b>Adjusting the Image Size (WUX450/WX520).....</b>	<b>57</b>
<b>Adjusting the Image Position.....</b>	<b>58</b>
■ WUX450/WX520 .....	58
■ WUX400ST/WX450ST.....	58
<b>Adjusting the Focus.....</b>	<b>59</b>
<b>Step 4 Select an Aspect Ratio (Screen Aspect)</b>	
<b>Matching the Screen.....</b>	<b>60</b>
Selecting Screen Aspect .....	60
Moving Image with 16:9 D. Image Shift.....	63
Moving Image with 4:3 D. Image Shift.....	64
Resetting the Image Shift .....	65
Selecting the Aspect.....	66
Types of Aspect Ratios .....	66
Selecting an Aspect Ratio .....	67
<b>Step 5 Correct the Image Distortion.....</b>	<b>68</b>
<b>Adjusting Keystone Distortion .....</b>	<b>68</b>
■ Horizontal/Vertical Keystone Correction .....	68
■ Corner Adjustment .....	69
■ Resetting the Keystone Adjustment.....	70

<b>Step 6 Select the Image Quality (Image Mode)</b> .....	<b>71</b>
Image Modes .....	71
■ Selecting an Image Mode .....	72
<b>Step 7 Set Power-Saving Settings</b> .....	<b>73</b>
<b>Step 8 Turn the Projector Off</b> .....	<b>74</b>
<b>Useful Functions Available During a Presentation</b> .....	<b>75</b>
<b>Useful Presentation Functions</b> .....	<b>76</b>
Temporarily Blacking Out an Image.....	76
Freezing the Picture.....	76
Adjusting the Volume .....	77
Muting the Sound.....	77
Zooming an Image .....	78
<b>Projecting Images on a USB Flash Drive</b> .....	<b>79</b>
<b>Split-Screen Display</b> .....	<b>81</b>
<b>Setting Functions from Menus</b> .....	<b>83</b>
<b>Using Menus</b> .....	<b>84</b>
Menu Configuration .....	84
Basic Menu Operations .....	85
<b>Setting Display Status (Input Settings)</b> .....	<b>87</b>
Selecting the Aspect.....	87
Setup Using Auto PC .....	88
Selecting an Input Signal .....	88
Adjusting the Input Signal (Total dots) .....	89
Adjusting the Input Signal (Tracking) .....	89
Adjusting the Input Signal (Horizontal position).....	90
Adjusting the Input Signal (Vertical Position) .....	90
Adjusting the Input Signal (Horizontal pixels).....	91
Adjusting the Input Signal (Vertical pixels) .....	91
Adjusting HDMI Input Level .....	92
Setting the HDMI Color Format.....	92
Specifying HDMI Overscan .....	93
Specifying Progressive Processing .....	93
Specifying the Slideshow Interval.....	94
Specifying Split-Screen Display .....	95
<b>Adjusting Image Quality (Image Adjustment)</b> .....	<b>96</b>
Specifying Image Priority in Split-Screen Mode .....	96



Specifying the Image Mode.....	97
Creating/Saving a User Profile.....	98
Adjusting Brightness.....	99
Adjusting Contrast.....	99
Adjusting Sharpness.....	100
Correcting Gamma.....	100
Adjusting Colors.....	101
Adjusting to the Ambient Light (Ambient Light).....	102
Reducing Image Noise (Noise reduction).....	103
Dynamic Gamma Adjustment.....	103
Correcting Memory Color.....	104
Fine-Tuning Colors (6-axis Color Adjustment).....	104
Fine-Tuning Gamma.....	105
Controlling Contrast (Iris).....	106
Specifying the Lamp Mode.....	107
Resetting Image Adjustment Settings.....	107
<b>Customizing System Operation (System Settings).....</b>	<b>108</b>
Registering User Logos.....	108
Positioning User Logos.....	108
No Signal Screen.....	109
Screen When Blank.....	109
Selecting a Logo at Startup.....	110
Specifying Auto Power-Off.....	110
Specifying Direct Power-On.....	111
Specifying Silence or Operating Tones.....	111
Specifying Key Repeat Operation.....	112
Locking Projector or Remote Buttons.....	112
Assigning a Channel for Remote Control.....	113
Reducing Motion Blur.....	114
Specifying HDMI Input.....	115
Selecting a Display Language.....	115
Requiring a Password for Operation.....	116
Setting a Password.....	117
Restoring Original Gamma Settings.....	118
Resetting the Lamp Counter.....	119
■ About the Display of the Lamp Counter.....	119
Resetting the Air Filter Counter.....	120

Updating the Firmware .....	121
Resetting to the Default Setting.....	121
Checking Projector Information .....	122
<b>Installation and Maintenance.....</b>	<b>123</b>
<b>Installation.....</b>	<b>125</b>
<b>Before Installation.....</b>	<b>126</b>
Precautions When Carrying/Shipping the Projector .....	126
Precautions for Installation.....	126
■ When Using Mounted on the Ceiling.....	128
■ Install Facing in the Correct Direction .....	129
<b>Installation Procedure .....</b>	<b>130</b>
<b>Setting Up the Projector .....</b>	<b>130</b>
■ Positioning the Projector in Front of the Screen.....	130
■ Floor Installation.....	130
■ Upward-Tilted Installation.....	130
■ Projection from High Surfaces .....	131
■ Ceiling Mounting or Rear Projection .....	132
<b>Relationship of Image Size to Projection Distance.....</b>	<b>133</b>
■ Lens Shift Function .....	134
■ Amount of Lens Shift.....	134
<b>Connection Procedure .....</b>	<b>136</b>
<b>Connectable Equipment and Input Terminals.....</b>	<b>136</b>
<b>Connecting a Computer .....</b>	<b>137</b>
■ Connecting to RGB Monitor Output Terminal (Analog Connection).....	137
■ Connecting to DVI Monitor Output Terminal (Digital Connection).....	138
■ Connecting with an HDMI cable (Input signal type: [HDMI]).....	139
■ Outputting Audio to Speakers .....	139
<b>Connecting AV Equipment.....</b>	<b>140</b>
■ Connecting to Digital Video Output Terminal (Digital Connection) .....	140
■ Connecting to Analog Video Output Terminal (Analog Connection).....	141
■ Outputting Audio to Speakers .....	142
<b>Plugging the Projector In .....</b>	<b>143</b>
<b>Starting Projection.....</b>	<b>144</b>
<b>Starting and Stopping Projection .....</b>	<b>144</b>
■ Starting Projection.....	144
■ Stopping Projection .....	144
■ When the Language Selection Screen Appears .....	144
■ When the Password Input Screen Appears .....	144
■ When “No signal” Appears .....	145
■ When Notebook Computer Screen Does Not Appear.....	145
■ Adjusting Image .....	145

<b>Changing Notebook Computer Screen Output</b> .....	145
■ Turning on External Monitor Output .....	145
<b>Installation-Related Menu Settings</b> .....	<b>146</b>
<b>Locking Installation Settings</b> .....	146
<b>Flipping Image Display</b> .....	146
<b>Specifying the Screen Aspect</b> .....	148
<b>Adjusting the Size of Projected Images (WUX400ST/WX450ST)</b> .....	149
<b>Specifying Keystone Correction</b> .....	150
<b>Specifying Digital Image Shift</b> .....	150
<b>Specifying Micro Digital Image Shift</b> .....	151
<b>Adjusting Image Registration</b> .....	151
<b>Specifying the Fan Mode</b> .....	152
<b>Specifying Vertical Projection</b> .....	152
<b>Selecting the Audio In Terminal</b> .....	153
<b>Adjusting Colors to Suit the Screen Color</b> .....	153
<b>Specifying a Menu Position</b> .....	154
<b>Showing/Hiding the Guide Screen</b> .....	154
<b>Showing/Hiding Input Status</b> .....	155
<b>Showing/Hiding Overheat Warnings</b> .....	155
<b>Specifying the Menu Display Time</b> .....	156
<b>Showing/Hiding Lamp Replacement Warnings</b> .....	156
<b>Showing/Hiding Filter Cleaning Warnings</b> .....	157
<b>Showing/Hiding Split-Screen ID</b> .....	157
<b>Showing/Hiding the Test Pattern</b> .....	158
<b>Projecting from Multiple Projectors at Once (Edge Blending)</b> .....	159
■ Basic Instructions .....	159
■ Advanced Instructions: Black Level Adjustment .....	162
■ Advanced Instructions: Smoother Overlapping Areas .....	164
<b>Connecting to a Network</b> .....	<b>167</b>
<b>Network Connection Overview</b> .....	168
<b>Connection Methods</b> .....	168
<b>Completing Projector Settings</b> .....	169
<b>Locking/Unlocking Network Settings</b> .....	169
<b>Enabling/Disabling the Network Password</b> .....	170
<b>Registering a Network Password</b> .....	171
<b>Enabling/Disabling Wired Network Functions</b> .....	171
<b>Specifying Standby Power Consumption</b> .....	172
<b>Viewing the IP Address</b> .....	172

## Table of Contents

Viewing the Gateway Address .....	173
Viewing the MAC Address.....	173
Enabling/Disabling DHCP.....	174
Specifying TCP/IP Settings .....	174
Initializing Network Settings .....	175
Specifying PJLink Settings .....	175
Specifying Use of AMX Device Discovery .....	176
Specifying Use of Crestron RoomView.....	177
<b>Completing Computer Settings.....</b>	<b>178</b>
<b>Specifying an IP Address .....</b>	<b>178</b>
■ Windows 7.....	178
■ Windows Vista.....	179
■ Windows XP .....	180
■ Mac OS X.....	180
■ Resetting the IP Address Setting of the Computer .....	181
<b>Setting Up the Network.....</b>	<b>181</b>
■ Displaying the Network Configuration Screen.....	181
■ Network Setting.....	183
■ Error Notification Mails .....	194
<b>Control via the Web Screen .....</b>	<b>195</b>
<b>Maintenance .....</b>	<b>197</b>
<b>Cleaning the Projector.....</b>	<b>198</b>
<b>Cleaning and Replacing the Air Filter.....</b>	<b>199</b>
Replacing the Air Filter.....	199
Cleaning the Air Filter.....	200
<b>Replacing the Lamp.....</b>	<b>201</b>
Replacement Lamp .....	202
Replacing the Lamp .....	202
■ If the Lamp Cover Comes Off .....	204
<b>Networked Multi-Projection (NMPJ).....</b>	<b>205</b>
<b>Networked Multi-Projection Overview .....</b>	<b>207</b>
<b>Introduction to Networked Multi-Projection.....</b>	<b>208</b>
■ Projection Over a Network .....	208
■ Split-Screen Projection of Multiple Images .....	208
■ Projection of an Image from Multiple Projectors at Once.....	208
■ Selecting the Projection Monitor .....	209

<b>Installing the NMPJ Application .....</b>	<b>210</b>
System Requirements .....	210
Installation .....	211
■ Uninstallation.....	213
<b>From Startup to Shutdown.....</b>	<b>215</b>
■ Projection Sessions.....	219
<b>Operation in Each Mode.....</b>	<b>221</b>
<b>Using the Projector in Direct Mode .....</b>	<b>222</b>
Procedure .....	222
Direct Mode Window.....	224
<b>Using the Projector in Meeting Mode.....</b>	<b>226</b>
Creating a Session.....	226
Joining a Session.....	232
Meeting Mode Window .....	234
<b>Using the Projector in Classroom Mode.....</b>	<b>236</b>
Leading a New Session .....	236
Joining an Existing Session .....	242
Classroom Mode Window (Starting a Session).....	245
Classroom Mode Window (Joining a Session) .....	247
<b>Using the Projector in Broadcast Mode.....</b>	<b>249</b>
Procedure .....	249
Broadcast Mode Window .....	252
<b>Functions in All Modes .....</b>	<b>255</b>
<b>Using the Session Selection Menu .....</b>	<b>256</b>
Session Selection Menu .....	256
Finding Sessions .....	257
<b>Using the Projector Selection Menu .....</b>	<b>258</b>
Projector Selection Menu .....	258
■ Finding Projectors .....	260
■ Selecting Password-Protected Projectors.....	261
■ Using the Favorites Function .....	262
■ Resorting the Projector List.....	263
■ Turning Projectors On .....	263

<b>Using Layout Functions .....</b>	<b>264</b>
■ Switching Projectors Used for the Layout .....	264
■ Controlling all Projectors at Once.....	264
■ Projecting from Multiple Projectors (Multi-Projection) .....	265
■ Switching the Primary/Secondary Monitor .....	266
■ Temporarily Enlarge Images .....	266
■ Projecting Session Information .....	267
■ Fully Blanking Projection.....	267
■ Blanking Projection from Your Computer.....	269
■ Checking for Computers That Join or Leave Sessions .....	270
<b>Completing Application Projection Settings.....</b>	<b>272</b>
<b>Reducing Windows to a Compact Size.....</b>	<b>274</b>
<b>Tips for Better Networked Projection .....</b>	<b>275</b>
■ Avoid Exceeding Connection Limits.....	275
■ Operation if Devices Are Disconnected .....	275
■ If Projectors Cannot Be Detected.....	275
<b>Restrictions .....</b>	<b>276</b>
■ Router Connections .....	276
■ Security Dialog Box Projection.....	276
■ Screen Capture Software.....	276
■ Animated Cursors .....	276
■ Alternative Cursors.....	276
■ Projection Restrictions .....	276
■ Network Bandwidth .....	276
■ Projection through Firewalls.....	276
■ Application Display.....	276
<b>Appendix .....</b>	<b>277</b>
<b>Appendix .....</b>	<b>279</b>
<b>Troubleshooting.....</b>	<b>280</b>
<b>LED Indicator Meanings .....</b>	<b>280</b>
<b>Symptoms and Solutions .....</b>	<b>281</b>
■ You Cannot Turn on the Projector .....	281
■ You Cannot Project an Image from the Projector .....	282
■ There is no Sound.....	283
■ The Projected Image Is Blurred .....	284
■ You Cannot Project an Image Appropriately.....	285
■ The Projector Power Turns Off .....	285
■ You Cannot Operate the Remote Control .....	286
■ You Cannot Control Networked Multi-Projection.....	286

<b>Relationship between Aspect and Screen Aspect.....</b>	<b>287</b>
■ When the image is projected on a 16:10 screen.....	287
■ When the image is projected on a 16:9 screen.....	288
■ When the image is projected on a 4:3 screen.....	288
■ When projecting on a 16:10 screen in the aspect ratio of the connected device.....	289
■ When projecting on a 16:9 screen in the aspect ratio of the connected device.....	289
■ When projecting on a 4:3 screen in the aspect ratio of the connected device.....	290
<b>Displayed Test Patterns .....</b>	<b>291</b>
<b>Supported Signal Types.....</b>	<b>292</b>
<b>Product Specifications .....</b>	<b>294</b>
■ Projector.....	294
■ Remote control.....	297
■ External View .....	298
■ ANALOG PC-2 / COMPONENT terminal.....	299
■ Service Port (CONTROL).....	299
<b>Index.....</b>	<b>302</b>
<b>Option .....</b>	<b>305</b>
<b>Menu Configuration .....</b>	<b>306</b>

# Safety Instructions

Before installing and operating the projector, read this manual thoroughly.

This projector provides many convenient features and functions. Operating the projector properly enables you to manage those features and maintain it in good condition for many years to come.

Improper operation may result in not only shortening the product life, but also malfunctions, fire hazards, or other accidents.

If your projector does not seem to be operating properly, read this manual again, check operations and cable connections, and try the solutions in the “Troubleshooting” section in the back of this manual. If the problem still persists, contact the Canon Customer Support Center.



CAUTION  
RISK OF ELECTRIC SHOCK  
DO NOT OPEN



**CAUTION: TO REDUCE THE RISK OF ELECTRIC SHOCK, DO NOT REMOVE COVER (OR BACK). NO USER-SERVICEABLE PARTS INSIDE EXCEPT LAMP REPLACEMENT. REFER SERVICING TO QUALIFIED SERVICE PERSONNEL.**



THIS SYMBOL INDICATES THAT DANGEROUS VOLTAGE CONSTITUTING A RISK OF ELECTRIC SHOCK IS PRESENT WITHIN THIS UNIT.



THIS SYMBOL INDICATES THAT THERE ARE IMPORTANT OPERATING AND MAINTENANCE INSTRUCTIONS FOR THIS UNIT IN THE OWNER'S MANUAL.

## CAUTION

Not for use in a computer room as defined in the Standard for the Protection of Electronic Computer / Data Processing Equipment, ANSI / NFPA 75.



## Safety Precautions

### WARNING:

- **THIS APPARATUS MUST BE GROUNDED.**
- **TO REDUCE THE RISK OF FIRE OR ELECTRIC SHOCK, DO NOT EXPOSE THIS APPLIANCE TO RAIN OR MOISTURE.**
- This projector produces intense light from the projection lens. Do not stare directly into the lens, otherwise eye damage could result. Be especially careful that children do not stare directly into the beam.
- Install the projector in a proper position. Otherwise it may result in a fire hazard.
- Allowing the proper amount of space on the top, sides, and rear of the projector cabinet is critical for proper air circulation and cooling of the unit. The diagrams shown here indicates the minimum space required. If the projector is to be built into a compartment or similarly enclosed, these minimum distances must be maintained.

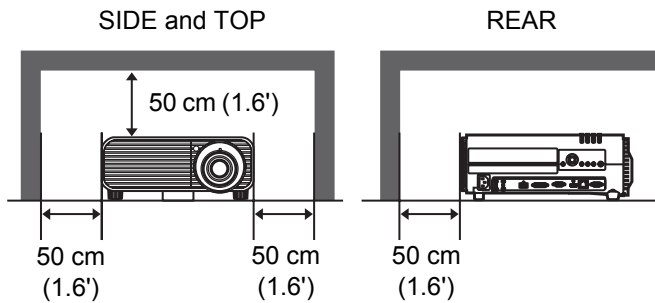

- Do not cover the ventilation slots on the projector. Heat build-up can reduce the service life of your projector, and can also be dangerous.
- If the projector is unused for an extended time, unplug the projector from the power outlet.
- Do not project the same image for a long time.

An afterimage may remain on the LCD panels due to the characteristics of the panels of the projector.

## CAUTION ON HANGING FROM THE CEILING

When hanging the projector from the ceiling, clean the air intake vents and top of the projector periodically with a vacuum cleaner. If you leave the projector unclean for a long time, the cooling fans can be clogged with dust, and it may cause a breakdown or a disaster.

**DO NOT SET THE PROJECTOR IN GREASY, WET, OR SMOKY CONDITIONS SUCH AS IN A KITCHEN TO PREVENT A BREAKDOWN OR A DISASTER. IF THE PROJECTOR COMES IN CONTACT WITH OIL OR CHEMICALS, IT MAY BECOME DETERIORATED.**

### ■ READ AND KEEP THIS OWNER'S MANUAL FOR LATER USE.

All the safety and operating instructions should be read before beginning to operate the product.

Read all of the instructions given here and retain them for later use. Unplug this projector from the AC power supply before cleaning. Do not use liquid or aerosol cleaners on the projector. Use a damp cloth for cleaning.

Follow all warnings and instructions marked on the projector.

For added protection of the projector during a lightning storm, or when it is left unattended or unused for long periods of time, unplug it from the wall outlet. This will prevent damage due to lightning and power surges.

---

Do not expose this unit to rain or use near water... for example, in a wet basement, near a swimming pool, etc...

Do not use attachments not recommended by the manufacturer as they may result in hazards.

Do not place this projector on an unstable cart, stand, or table. The projector may fall, causing serious injury to a child or adult, and serious damage to the projector. Use only with a cart or stand recommended by the manufacturer, or sold with the projector. Wall or shelf mounting should be carried out in accordance with the manufacturer's directions, and should use a mounting kit approved by the manufacturers.

An appliance and cart combination should be moved with care. Sudden stops, excessive force, and uneven surfaces may cause the appliance and cart combination to overturn.



Slots and openings in the rear and front of the cabinet are provided for ventilation, to insure reliable operation of the equipment and to protect it from overheating.

The openings should never be covered with cloth or other materials, and the bottom opening should not be blocked by placing the projector on a bed, sofa, rug, or other similar surface. This projector should never be placed near or over a radiator or heat register.

This projector should not be placed in a built-in installation such as a book case unless proper ventilation is provided.

Never push objects of any kind into this projector through cabinet slots as they may touch dangerous voltage points or short out parts that could result in a fire or electric shock. Never spill liquid of any kind onto the projector.

Do not install the projector near the ventilation duct of air-conditioning equipment.

This projector should be operated using only the type of power source indicated on the marking label. If you are not sure of the type of power supplied, contact the Canon Customer Support Center or local power company.

Do not overload wall outlets and extension cords as this can result in fire or electric shock. Do not allow anything to rest on the power cord. Do not locate this projector where the cord may be damaged by people walking on it.

Do not attempt to service this projector yourself as opening or removing covers may expose you to dangerous voltages or other hazards. Refer all servicing to qualified service personnel.

Unplug this projector from the wall outlet and refer servicing to qualified service personnel under the following conditions:

- a. When the power cord or plug is damaged or frayed.
- b. If liquid has been spilled into the projector.
- c. If the projector has been exposed to rain or water.
- d. If the projector does not operate normally after following the operating instructions. Adjust only those controls that are covered in the operating instructions as improper adjustment of other controls may result in damage and will often require extensive work by a qualified technician to restore the projector to normal operating condition.
- e. If the projector has been dropped or the cabinet has been damaged.
- f. When the projector exhibits a distinct change in performance-this indicates a need for servicing.

When replacement parts are required, be sure the service technician uses replacement parts specified by the manufacturer that have the same characteristics as the original parts. Unauthorized substitutions may result in fire, electric shock, or injury.

Upon completion of any service or repairs to this projector, ask the service technician to perform routine safety checks to determine that the projector is in safe operating condition.

## AC Power Cord Requirement

The AC Power Cord supplied with this projector meets the requirements for use in the country you purchased it.

### AC Power Cord for the United States and Canada:

The AC Power Cord used in the United States and Canada is listed by the Underwriters Laboratories (UL) and certified by the Canadian Standard Association (CSA).

The AC Power Cord has a grounding-type AC line plug. This is a safety feature to ensure the plug fits into the power outlet. Do not try to tamper with this safety feature. Should you be unable to insert the plug into the outlet, contact your electrician.

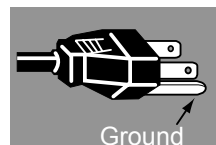

**THE SOCKET-OUTLET SHOULD BE INSTALLED NEAR THE EQUIPMENT AND EASILY ACCESSIBLE.**

### NOTE FOR CUSTOMERS IN THE US

 LAMP(S) INSIDE THIS PRODUCT CONTAIN MERCURY AND MUST BE RECYCLED OR DISPOSED OF ACCORDING TO LOCAL, STATE OR FEDERAL LAWS.



### Only for European Union and EEA (Norway, Iceland and Liechtenstein)

These symbols indicate that this product is not to be disposed of with your household waste, according to the WEEE Directive (2012/19/EU), the Battery Directive (2006/66/EC) and/or national legislation implementing those Directives.



If a chemical symbol is printed beneath the symbol shown above, in accordance with the Battery Directive, this indicates that a heavy metal (Hg = Mercury, Cd = Cadmium, Pb = Lead) is present in this battery or accumulator at a concentration above an applicable threshold specified in the Battery Directive.



This product should be handed over to a designated collection point, e.g., on an authorized one-for-one basis when you buy a new similar product or to an authorized collection site for recycling waste electrical and electronic equipment (EEE) and batteries and accumulators. Improper handling of this type of waste could have a possible impact on the environment and human health due to potentially hazardous substances that are generally associated with EEE. Your cooperation in the correct disposal of this product will contribute to the effective usage of natural resources.

For more information about the recycling of this product, please contact your local city office, waste authority, approved scheme or your household waste disposal service or visit

[www.canon-europe.com/weee](http://www.canon-europe.com/weee), or [www.canon-europe.com/battery](http://www.canon-europe.com/battery).

## **Federal Communication Commission Notice**

Multimedia Projector, Model: WUX450/WX520/WUX400ST/WX450ST

This device complies with Part 15 of the FCC Rules. Operation is subject to the following two conditions:

- (1) This device may not cause harmful interference, and
- (2) this device must accept any interference received, including interference that may cause undesired operation.

Note: This equipment has been tested and found to comply with the limits for a Class B digital device, pursuant to Part 15 of the FCC Rules. These limits are designed to provide reasonable protection against harmful interference in a residential installation. This equipment generates, uses and can radiate radio frequency energy and, if not installed and used in accordance with the instructions, may cause harmful interference to radio communications. However, there is no guarantee that interference will not occur in a particular installation. If this equipment does cause harmful interference to radio or television reception, which can be determined by turning the equipment off and on, the user is encouraged to try to correct the interference by one or more of the following measures:

- Reorient or relocate the receiving antenna.
- Increase the separation between the equipment and receiver.
- Connect the equipment into an outlet on a circuit different from that to which the receiver is connected.
- Consult the dealer or an experienced radio / TV technician for help.

The cable with a ferrite core provided with the projector must be used with this equipment in order to comply with Class B limits in Subpart B of Part 15 of the FCC rules.

Use of a shielded cable is required to comply with class B limits in Subpart B of Part 15 of FCC Rules.

Do not make any changes or modifications to the equipment unless otherwise specified in the instructions. If such changes or modifications should be made, you could be required to stop operation of the equipment.

Canon U.S.A. Inc.

One Canon Park, Melville, New York 11747, U.S.A.





Tel No. (631) 330-5000

## **Canadian Radio Interference Regulations**

This Class B digital apparatus complies with Canadian ICES-003.

### Safety Symbols in this Manual

This section describes the safety symbols used in this manual. Important projector safety information is identified by the following symbols. Always observe the safety information by these symbols.

 <b>Warning</b>	Denotes the risk of death or serious injury from improper handling if the information is not observed. To ensure safe use, always observe this information.
 <b>Caution</b>	Denotes the risk of injury from improper handling if the information is not observed. To ensure safe use, always observe this information.
 Prohibition	Denotes prohibited actions.
 Caution	Denotes required actions or information that must be observed.

## Precautions for Use

As this section contains important safety-related information, be sure to read the following carefully beforehand in order to use your projector correctly and safely.

### Warning

If the following situations occur, turn the power off, remove the power plug from the power outlet and contact the Canon Customer Support Center. Failure to do so could cause a fire or result in an electric shock.

- If smoke is emitted
- If an unusual smell or noise is emitted
- If a loud noise is heard and the lamp turns off
- If water or other liquid has entered the projector
- If metal or any other foreign material has entered the projector
- If the projector is knocked over or dropped and the cabinet is damaged

### Warning

Pay attention to the following points for handling the power cord. Failure to do so may cause a fire, electric shock or personal injury.



Prohibition

- Do not place any objects on the power cord and do not allow it to become trapped under the projector. The power cord may be damaged.
- Do not cover the power cord with a carpet.
- Do not excessively bend, twist, pull or make modifications to the power cord.
- Keep the power cord away from heaters and other sources of heat.
- Do not use the power cord when it is bent finely, coiled or bundled.
- Do not use a damaged power cord. If your power cord is damaged, contact the Canon Customer Support Center.
- Do not use any power cord other than the type that is included with this projector.
  
- Be sure to connect the ground wire of the power cord to ground. Failure to do so could result in an electric shock.
- Be sure to connect the ground wire before connecting the power plug to the outlet. Also when you disconnect the ground wire, be sure to unplug the power plug from the outlet beforehand.

### Warning

Pay attention to the following points regarding the power source, power plug and handling of the connector. Failure to do so may cause a fire, electric shock or personal injury.



Prohibition

- Do not use any power source with a voltage other than the voltage indicated (AC 100–240 V).
- Do not pull the power cord and be sure to hold the power plug or connector when removing. The cord could be damaged as a result.
- Do not insert any metal objects into the contact parts of the power plug or connector.
- Remove the power plug from the outlet before performing cleaning or maintenance of the projector.



Caution

- Do not remove the power plug or connector with wet hands.
- Insert the power plug and connector securely up to the base. Additionally, do not use a damaged power plug or an outlet that is loose.
- If using an extension cord attached to the outlet, make sure that the total electric power consumption of connected devices does not exceed the rated capacity.



Caution

- Periodically inspect the power plug and outlet and remove any dust or dirt from between the plug and the outlet.

## Precautions for Installation

### Warning

Pay attention to the following points regarding installation and handling of the projector. Failure to do so may cause a fire, electric shock or personal injury.

- Do not use the projector in a bathroom or shower room.
- Do not use the projector in rain or snow, by the sea, or in close proximity to a body of water.
- Do not place containers containing a liquid on top of the projector.
- Do not place the projector in any location where it will be exposed to oily smoke or steam, such as a kitchen work surface or table etc.
- Do not touch the projector itself, the power cord, or the cable if lightning strikes.



## Warning

Pay attention to the following points regarding installation and handling of the projector. Failure to do so may cause a fire, electric shock or personal injury.



- Do not move the projector until you have switched off the power, removed the power plug from the power outlet and unplugged any other cables.
- Do not remove the cabinet from the projector or disassemble it. The interior of the projector contains high-voltage components as well as parts that are hot. These could cause an electric shock or burn. If inspection, maintenance or repair is required, contact the Canon Customer Support Center.
- Do not disassemble or modify the projector (including consumable parts) or the remote control.
- Do not look directly into the exhaust vents during use.



- Do not insert any object into vents in the projector, such as the air intake vent or exhaust vents.
- Do not place a pressurized can in front of the exhaust vents. The pressure of the contents of the can may increase due to heat from the exhaust vents and this could result in an explosion.
- As strong light beams are emitted while the projector is in use, do not look directly into the projector lens. Doing so could cause an eye injury. Pay particular attention to prevent small children from doing so.
- When giving a presentation in front of the projector while it is projecting an image, conduct your presentation from a position where your shadow will not be cast on the screen and where you do not feel blinded by light from the projector.
- When setting the projector on a high surface for projection, be sure the surface is flat and stable. Failure to do so could result in the projector falling down and causing an accident or personal injury.

## Caution

Pay attention to the following points regarding installation and handling of the projector.



- If the projector will not be used for a long period of time, be sure to remove the power plug from the power outlet to ensure safety. Failure to do so could cause a fire.
- The temperature of the cabinet around and above the exhaust vents can become hot during projector operation. Touching these areas during operation could cause burns to the hands. Do not touch these areas. Doing so may cause burns. Pay particular attention in preventing young children from touching these parts. Additionally, do not place any metal objects on these areas. Due to the heat from the projector, doing so could cause an accident or personal injury.

### **Caution**

Pay attention to the following points regarding installation and handling of the projector.



- Do not place any heavy objects on top of the projector or sit / stand on it. Pay particular attention to prevent small children from doing so. The projector may be knocked over and this could result in damage or a personal injury.
- Do not place the projector on an unstable or slanted surface. Doing so may cause the projector to fall or be knocked over and could result in a personal injury.
- Do not place any objects in front of the lens while the projector is operating. Doing so could cause a fire.
- When cleaning off dust or dirt from the projector lens etc., do not use any kind of spray that is flammable. As the temperature of the lamp inside the projector is high, it could ignite, causing a fire.



- If the projector is used for a long period of time, dust could accumulate inside the projector. This could cause a fire or malfunction. It is recommended that periodic maintenance of the projector be performed. For details of maintenance costs, contact the Canon Customer Support Center.

## Precautions on the lamp

This projector uses a high-pressure mercury lamp, which must be handled carefully and correctly as described below.

The mercury lamp has the following characteristics.

- Impact, abrasion, or use after the lamp's useful life has expired may damage lamps (which may be accompanied by a loud noise) or cause them to burn out.
- Useful life of lamps varies widely from lamp to lamp and depending on the environment of use. Lamps are not guaranteed to last for the same amount of time, and some lamps may fail sooner than others.
- The lamp will gradually become darker over time.

### **Warning**

When replacing the lamp, or when the lamp is damaged, pay attention to the following points. Failure to do so could result in an electric shock or personal injury.



- Be sure to remove the power plug from the power outlet before replacing the lamp.
- When the lamp is damaged, shards of glass may be scattered inside the projector. Contact the Canon Customer Support Center for cleaning and inspection of the projector interior and lamp replacement.
- Precautions when replacing lamps that stop working  
If the illumination suddenly stops when the projector is in use or after you turn it on, the lamp may be broken. In this case, never attempt to replace the lamp by yourself. Always request service from the Canon Customer Support Center. Additionally, with ceiling-mounted projectors, the lamp may fall out when you open the lamp cover or while you are attempting to replace it. During replacement, stand to the side of the lamp cover, not directly under it. If the lamp breaks and any glass shards or other pieces get in your eyes or mouth, consult a doctor immediately.

## Warning



Caution

- If the lamp is damaged, gas inside the lamp (containing mercury) and dust may be emitted from the exhaust vents. If this happens, immediately open the windows and doors to provide ventilation to the room. If you inhale any gas emitted from the lamp or it has come into contact with your eyes or mouth, consult a doctor immediately.

## Caution

When handling the lamp, pay attention to the following points.



Prohibition

- Be sure not to handle the lamp immediately after it has been used. Be sure to switch off the power and wait for approximately 1 hour for the lamp and the projector to cool down sufficiently. Failure to do so could result in a burn or personal injury due to heat from the lamp or projector.



Caution

- When an instruction to replace the lamp has been displayed (LAMP Indicator Displays (P43)), the possibility of the lamp breaking will increase. Replace the lamp with a new one as soon as possible.
- When disposing of a used mercury lamp, dispose of it in the same way as a fluorescent lamp and in accordance with the local regulations where you live.

## Precautions for the batteries of the remote control

### Warning

Pay attention to the following points regarding handling of batteries. Failing to do so could result in a fire or personal injury.



Prohibition

- Do not heat, short circuit or disassemble the batteries, or place them in a fire.
- Do not attempt to recharge the batteries that are included with the remote control.



Caution

- Remove the batteries when they are flat or when the remote control will not be used for a long period of time.
- When replacing the batteries, replace both at the same time. Also, do not use two batteries of a different type at the same time.
- Insert the batteries with the + and - terminals in the correct directions.
- If any liquid from inside the batteries leaks out and contacts your skin, be sure to wash the liquid off thoroughly.

## **Caution**

Pay attention to the following points when carrying or transporting the projector.



Caution

- This projector is a precision instrument. Do not knock it over or subject it to impacts. Doing so may cause a malfunction.
- Do not reuse any packaging or shock-absorbent materials that were supplied with the projector at the time of purchase for transporting or shipping the projector. Protection of the projector cannot be guaranteed if used packaging or shock-absorbent materials are reused. Fragments from shock-absorbent material may also enter the interior of the projector which could cause a malfunction.
- Disconnect the cables connected to the projector. Carrying the projector with the cables attached may cause an accident.
- Retract the adjustable feet.
- Attach the lens cap to protect the lens. (WUX450/WX520)

## ! Caution

Pay attention to the following points when installing or using the projector.

- Do not touch the lens with bare hands. Doing so may result in deterioration of image quality.
- If the projector is suddenly moved from a location where the temperature is low to a location where the temperature is high, or if the temperature in the location where the projector is installed increases suddenly, moisture in the air could cause condensation to form on the projector lens or mirror. This may cause a blurred image. Wait until the condensation has evaporated for the image projected to return to normal.
- Do not install the projector in a location where the temperature is high or low. Doing so may cause a malfunction. The temperature range for operation and storage are as follows.
  - Operating temperature: 0°C (32°F) to 40°C (104°F) Humidity level: up to 85%
  - Storage temperature: -10°C (14°F) to 60°C (140°F)
- Do not place any objects on top of the projector that may change shape or color due to heat.
- When using the projector at altitudes greater than 2,300 m (7,545.8'), or for projecting upward / downward:
  - When using the projector at altitudes greater than 2,300 m (7,545.8'), or for upward projection or downward projection, it is necessary to change the settings of the projector. Specifically, adjust [Fan mode] (P152) or [Vertical projection] (P152) in the [Install settings] menu.
- Do not install the projector near high-voltage electrical power lines or an electrical power source.
- Do not use the projector on a soft surface such as carpet or sponge mat, etc. Doing so could cause heat to build up inside the projector and this could result in a malfunction.
- Do not block the air intake or exhaust vents of the cooling fan. If the air intake or exhaust vent is blocked, heat cannot be released from inside the projector, which may shorten the useful life of the lamp or cause malfunction.
- Installing the projector in the wrong direction may cause a malfunction or accident. Install the projector so that the left / right incline is within 10°.
- Be sure to install the projector in a location where the air intake and exhaust vents are separated from the wall by more than 50 cm (1.6'). Failure to do so could cause a malfunction.
- Do not install the projector in a location that is damp, or where there is a lot of dust, oily smoke or tobacco smoke. Doing so could cause contamination of optical components such as the lens and the mirror and may result in deterioration of image quality.



Caution



# Before Use

Table of Contents

Safety Instructions

**Before Use**

**Operation**

Projecting an Image

Useful Functions Available  
During a Presentation

Setting Functions from  
Menus

**Installation and Maintenance**

Installation

Connecting to a Network

Maintenance

**Networked Multi-Projection**

Networked Multi-Projection  
Overview

Operation in Each Mode

Functions in All Modes

**Appendix**

Other Information

Index

# Supplied Accessories

Check that the following accessories have been supplied with the projector.

- Remote control

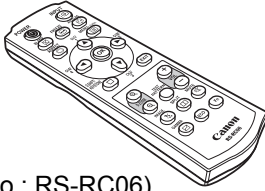

(part No.: RS-RC06)



Optional remote controls are also available (RS-RC04, RS-RC05). However, some buttons are not supported with this projector. The RS-RC05 can also be used as a wired remote. (P36)

- Batteries for the remote control

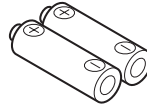

(AAA size x2)

- Lens cap



WUX400ST/  
WX450ST  
projectors do not  
include a lens cap.

- Computer cable (1.8 m / 5.9')  
(mini D-sub 15-pin / mini D-sub 15-pin)

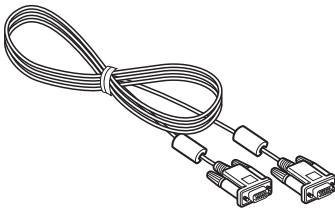

- User's Manual (CD-ROM)



- Power cord (1.8 m / 5.9')

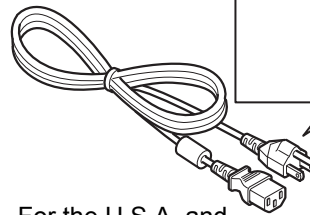

For Continental  
Europe

For the U.S.A. and  
Canada

- Warranty Card

- Important Information



## ■ Attaching the Lens Cap (WUX450/WX520)

Align the lens cap notch with the optical zoom adjustment lever as shown and attach the cap.



- **Always remove the cap before projection. Accidentally leaving the cap on during projection may distort the cap and damage the projector.**
- **Align the notch with the optical zoom adjustment lever and attach.**

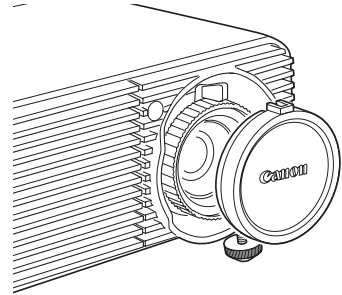

WUX400ST/WX450ST projectors do not include a lens cap.

# Preparing the Remote Control

## ■ Installing Remote Control Batteries

- 1** **Open the battery compartment lid.**  
Slide the lid while pressing it down.

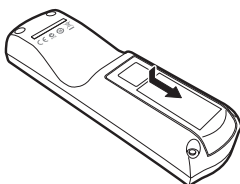

- 2** **Insert batteries.**  
Insert 2 new AAA batteries in the compartment with the + and – poles positioned correctly.

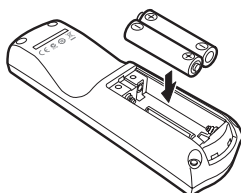

- 3** **Close the compartment lid.**  
Slide the lid until you hear a click to securely close it.

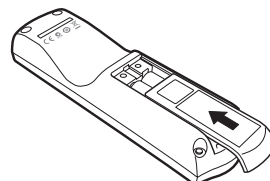

- If buttons on the remote control are inoperative when you attempt to operate the projector, replace the batteries with new ones.
- Do not drop the remote control or subject it to impact.
- Do not spill any liquids on the remote control. Doing so could damage it.



Prohibition



Caution

**Pay attention to the following points when handling the batteries. Failing to do so could result in a fire or personal injury.**

- **Do not heat, short circuit or disassemble the batteries, or place them in a fire.**
- **Do not attempt to recharge the batteries that are included with the remote control.**
- **Remove the batteries when they are flat or when the remote control will not be used for a long period of time.**
- **When replacing the batteries, replace both at the same time. Also, do not use two batteries of a different type at the same time.**
- **Insert the batteries with the + and - terminals in the correct directions.**
- **If any liquid from inside the batteries leaks out and contacts your skin, be sure to wash the liquid off thoroughly.**

## ■ Remote Control Operating Range

The remote control is an infrared type. Point it at the infrared remote receiver on the front or rear of the projector to operate it.

### WUX450/WX520

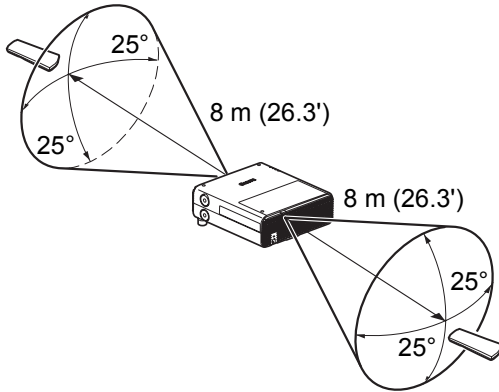

### WUX400ST/WX450ST

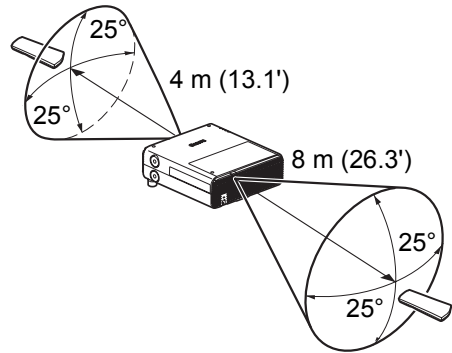

- Use the remote control within an angle of 25° in any direction from directly in front of the infrared remote receiver.
- The remote control may be inoperative if there is an obstacle between the remote control and the projector or the infrared remote receiver on the projector is exposed to direct sunlight or strong light of lighting equipment.
- When you use 2 or more projectors at the same time, you can change the channel settings to prevent the 2 remote controls from interfering with each other. (P113)

### ■ Using an Optional Wired Remote (RS-RC05)

To use a wired remote control with the projector, use the RS-RC05, sold separately. Use a cable with a  $\varnothing 3.5$  mm stereo mini jack (not included).

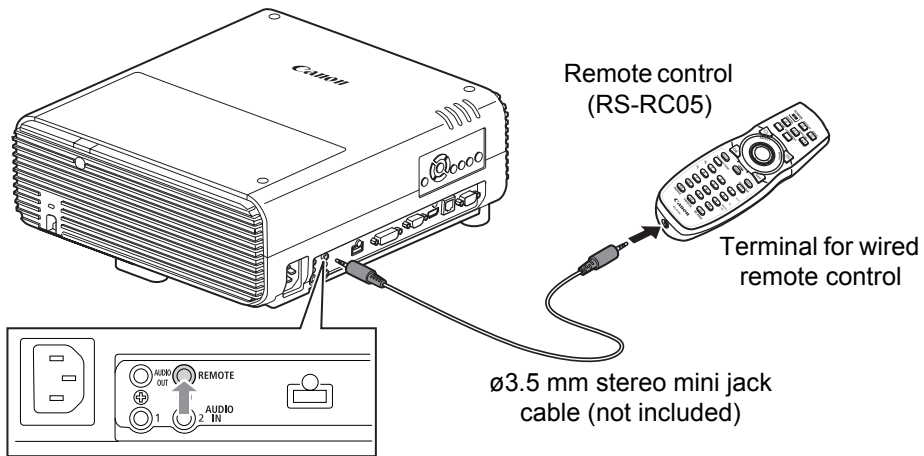

- Infrared operations cannot be performed if a cable is connected to the projector or the remote control.
- Use a cable with a  $\varnothing 3.5$  mm stereo mini jack (not included) with a length of 30 m (98.4') or less.

## Projector (WUX450/WX520)

### ■ Front Side

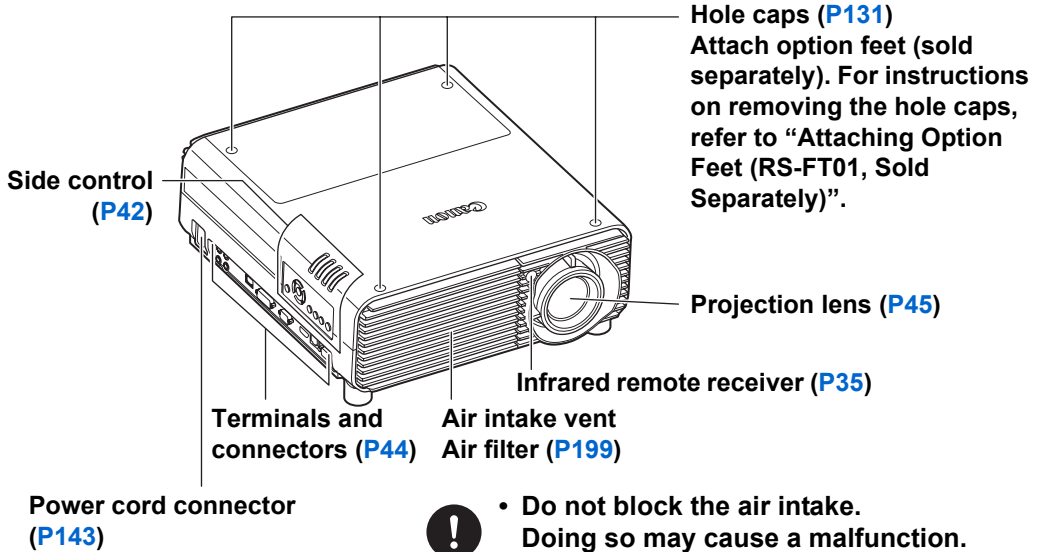

Caution

- Do not block the air intake. Doing so may cause a malfunction.
- Before projection, always remove the cap. Leaving the cap on may damage the projector.

### ■ Rear Side

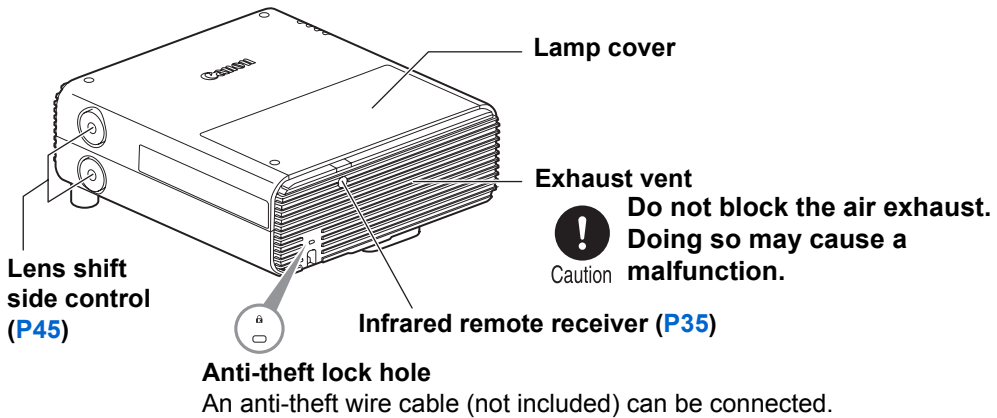

Caution

- Do not block the air exhaust. Doing so may cause a malfunction.

### ■ Bottom Side

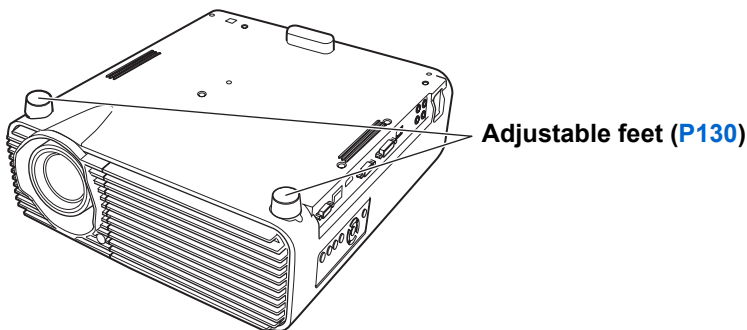

# Projector (WUX400ST/WX450ST)

## ■ Front Side

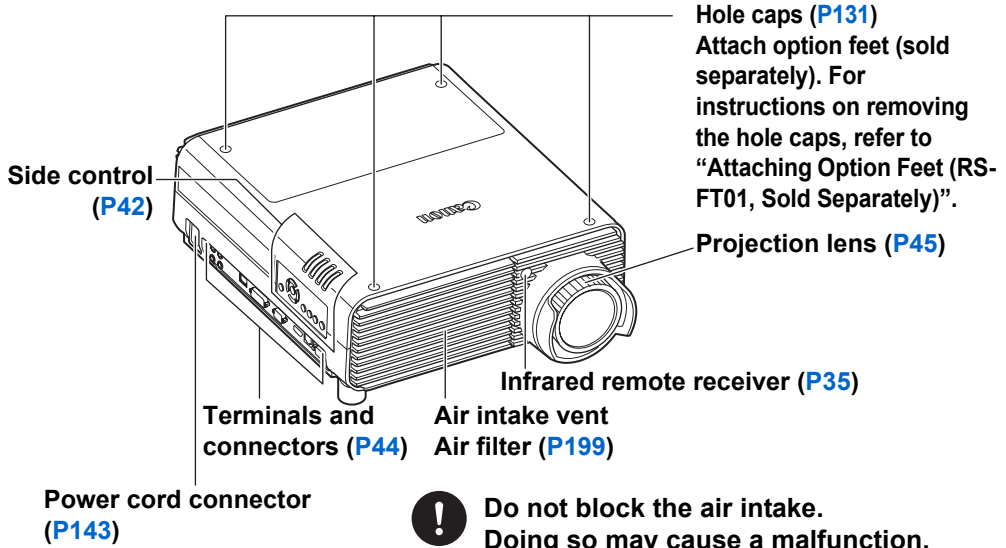

## ■ Rear Side

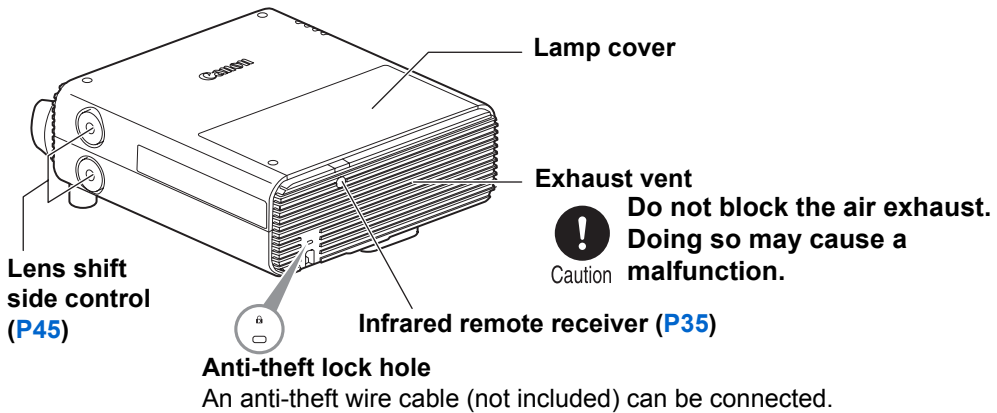

## ■ Bottom Side

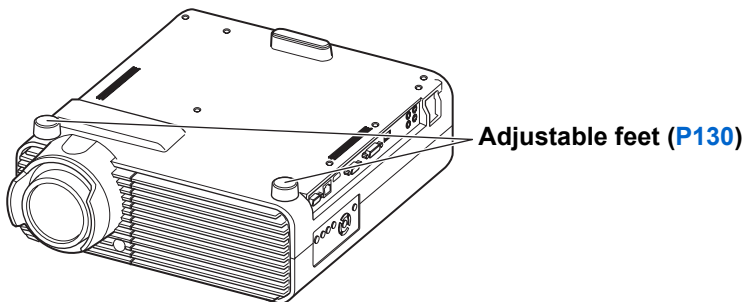

## Mounting the Projector on the Ceiling

You can mount the projector on the ceiling.

The ceiling attachment (part No.: RS-CL12 (WUX450/WX520), RS-CL13 (WUX400ST/WX450ST)) is required in order to mount the projector on the ceiling. Depending on the installation environment, an extension pipe (part No.: RS-CL08 or RS-CL09) may also be required. Contact the Canon Customer Support Center for more detailed information.



Caution

- **Make sure to use the optional ceiling attachment.**
- **You should never install the ceiling attachment by yourself.**



If you mount the projector on the ceiling, you have to invert the projected image by selecting [Image flip H/V] from the menu. (P146)

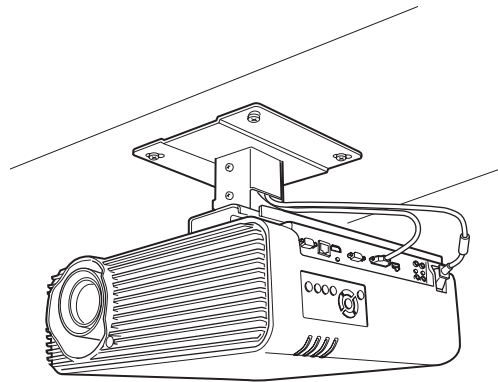

## Remote control

The projector can be operated using buttons on the remote control or the side control on the projector.

The remote control allows you to operate all functions of the projector.

### POWER button (P52, P74)

Turns the projector on or off.

### BLANK button (P76)

Toggles between display / non-display of image.

### ASPECT button (P67)

Changes the aspect ratio mode.

### KEystone button (P68)

Corrects keystone distortion. The [Keystone] setting enables both horizontal/vertical keystone correction (by adjusting top/bottom/left/right length) and corner correction.

### D.ZOOM button (P78)

Zooms the image in or out digitally.

[+] button: Zooms the image in (up to 12x).

[-] button: Zooms the image out (1x minimum).

[▲] / [▼] / [◀] / [▶] buttons: Move the zoom-in location.

### IMAGE button (P71)

Switches the image mode (image quality).

### GAMMA button (P100)

Adjusts the gamma of the image.

[▶] button: Corrects dark parts of the image so that they are easier to see.

[◀] button: Corrects bright parts of the image so that they are easier to see.

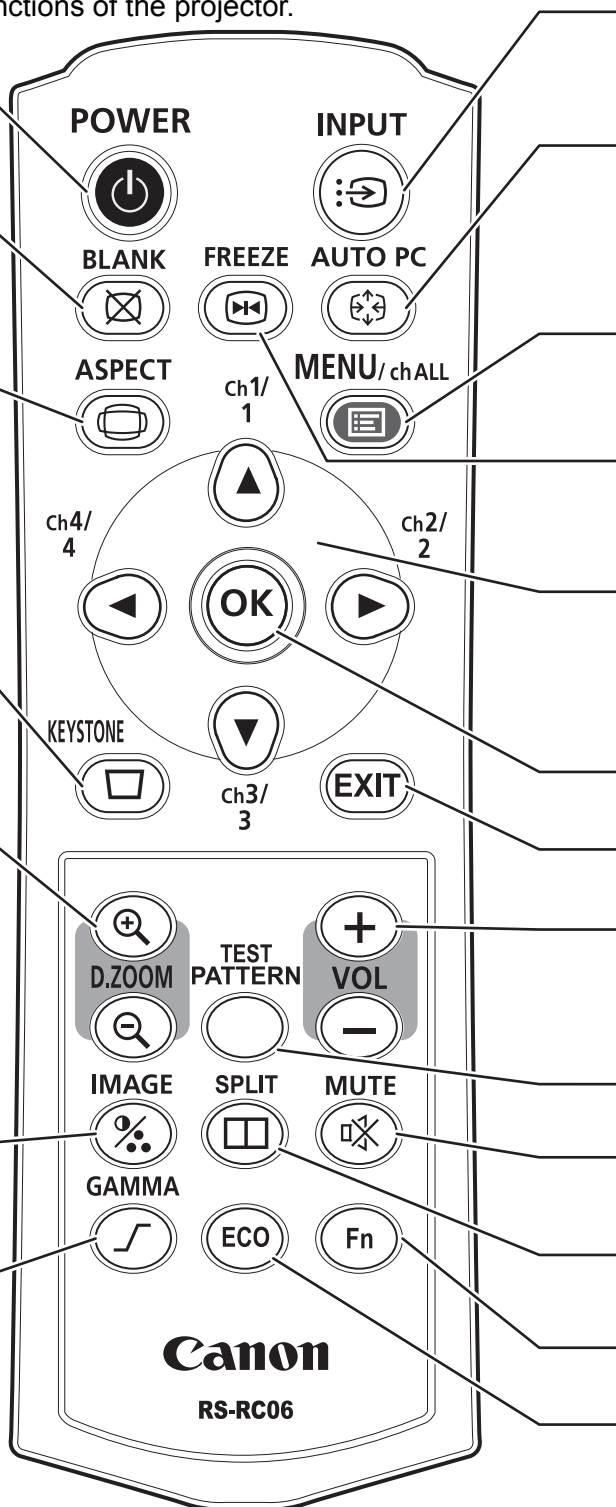



**INPUT button (P54)**

Switches the input signal.

**AUTO PC button (P57)**

Adjusts tracking etc. automatically in accordance with the signal from a computer when the analog PC input is selected.

**MENU button (P84)**

Displays a menu on the screen. Also used to assign a channel to the remote control. (P113)

**FREEZE button (P76)**

Freezes the projected image.

**Pointer buttons (P85)**

Selects the upper, lower, left or right item in the menu. Also used to assign a channel to the remote control. (P113)

**OK button (P85)**

Determines the item selected from the menu.

**EXIT button (P86)**

Cancels functions such as menu display or test pattern during operation and returns to the image display.

**VOL button (P77)**

Adjusts the sound volume.

[+] button: Increases the volume.

[-] button: Decreases the volume.

**TEST PATTERN button (P158)**

Displays the test pattern.

**MUTE button (P77)**

Mutes the sound.

**SPLIT button (P81)**

Activates the split screen function.

**Fn button**

Cannot be used on this product.

**ECO button (P73)**

Displays the Eco menu, to complete power-saving settings.

## Side Control

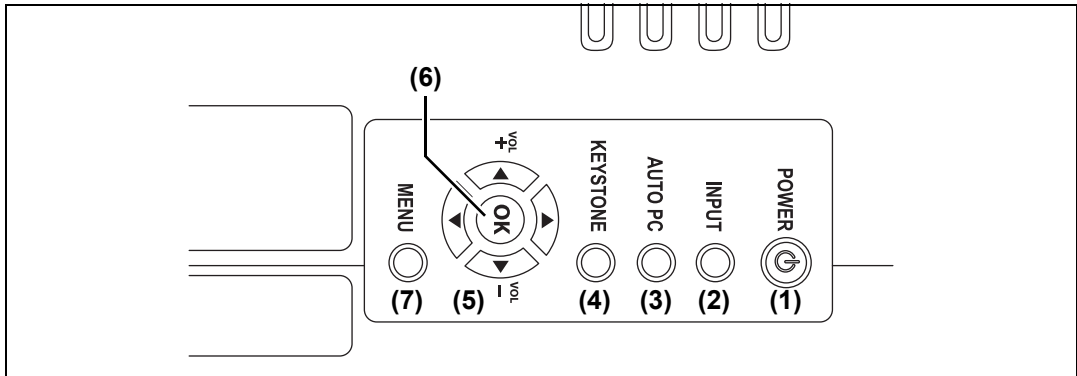

- |   |  |
|---|--|
| <p><b>(1) POWER button (P52, P74)</b><br/>Turns the projector on or off.</p> <p><b>(2) INPUT button (P54)</b><br/>Switches the input signal.</p> <p><b>(3) AUTO PC button (P57)</b><br/>Adjusts tracking etc. automatically in accordance with the signal from a computer when the analog PC input is selected.</p> <p><b>(4) KEYSTONE button (P68)</b><br/>Corrects keystone distortion.</p> | <p><b>(5) Pointer / VOL buttons (P77, P85)</b><br/>Adjust the sound volume.<br/>[▲] VOL+ button: Increases the volume.<br/>[▼] VOL– button: Decreases the volume.<br/>Selects the upper, lower, left or right item in the menu.</p> <p><b>(6) OK button (P85)</b><br/>Determines the item selected from the menu.</p> <p><b>(7) MENU button (P84)</b><br/>Displays a menu on the screen.</p> |
|---|--|

## LED indicators

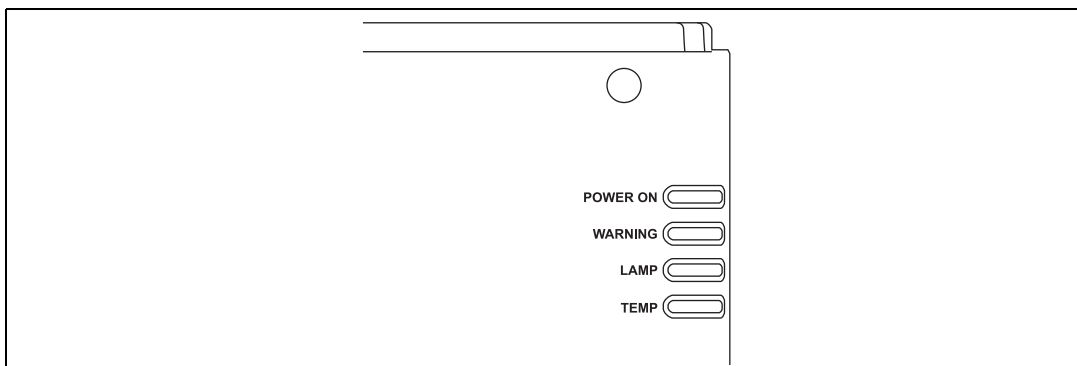

The projector status is shown by the LED indicators (off / lit / flashing).  
For indicator status, refer to “LED Indicator Displays” (P43).

- POWER ON (green) : Lights up or flashes under normal conditions when the power is on.
- WARNING (red) : Lights up or flashes when an error occurs.
- LAMP (orange) : Flashes when the time for replacing the lamp is near. When a lamp cover error occurs, the [WARNING] indicator will also flash. When a lamp error occurs, it will illuminate at the same time as the [WARNING] indicator.
- TEMP (red) : When the temperature inside the projector is high, it will flash. If the temperature inside the projector increases further and a temperature error occurs, it will illuminate at the same time that the [WARNING] indicator illuminates.

## ■ LED Indicator Displays



The LED indicators flash or illuminate to indicate the operating status of the projector.

□: Off ■: Lit ■◻: Flashing

LED indicator				Operating status
POWER ON (green)	WARNING (red)	LAMP (orange)	TEMP (red)	
□	□	□	□	Projector in standby mode or not plugged in.
■	□	□	□	Power is on.
■◻	□	□	□	Waking from or entering standby mode.
□	□	■◻	□	The time for replacing the lamp is near. (In standby mode.)
■	□	■◻	□	The time for replacing the lamp is near. (When POWER ON is lit.)
■	□	□	■◻	Internal temperature is high.
□	■	■	□	A lamp error has occurred.
□	■	□	■	Power was turned off due to high internal temperature.
□	■◻	■	□	The lamp cover is open.
□	■◻	□	□	Another error has occurred.

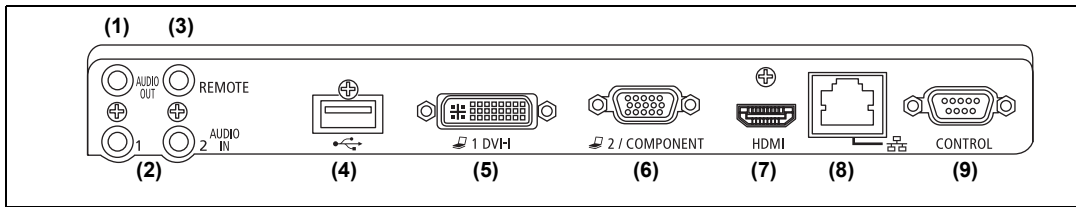
# Input Terminal



- (1) **AUDIO OUT terminal (AUDIO OUT) (P139, P142)**  
Outputs the audio to external AV equipment. This outputs the audio signal that corresponds to the projected image signal.
- (2) **AUDIO IN terminal (AUDIO IN) (P137, P138, P141)**  
Receives the audio signal input for 2 kinds of image input other than HDMI. The internal speaker outputs the audio for the selected image signal.
- (3) **Terminal for wired remote control (REMOTE) (P36)**  
This terminal is used to connect the remote control using a cable.
- (4) **USB port (P79)**  
Connects a USB flash drive. Used for projection of images on a USB flash drive, or for firmware updates.
- (5) **DVI-I input terminal (  1 DVI-I) (P138)**  
Connects the external monitor output from a computer.  
Receives analog and digital PC signals (Analog PC-1 and Digital PC, respectively).
- (6) **ANALOG PC / COMPONENT input terminal (  2 / COMPONENT) (P137, P141)**  
Receives the analog PC signal (Analog PC-2).  
A component cable can be used to receive the component image signal (Component).
- (7) **HDMI input terminal (HDMI) (P139)**  
Receives digital video signals (HDMI).  
Carries both video and audio signals across a single cable.
- (8) **LAN port (P168)**  
Connects the LAN cable (shielded twisted pair).  
Used to connect the projector to a network.
- (9) **Service port (CONTROL)**  
It is not used during ordinary use.

## Lens Shift Control

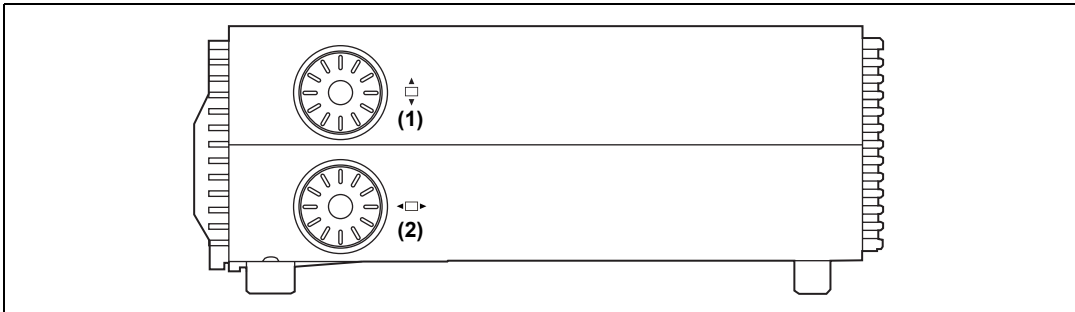

- (1) **Vertical lens shift dial**  
Slides the lens up or down for vertical image adjustment.
- (2) **Horizontal lens shift dial**  
Slides the lens left or right for horizontal image adjustment. For details on lens shift, refer to “Lens Shift Function” (P134).

## Projection Lens

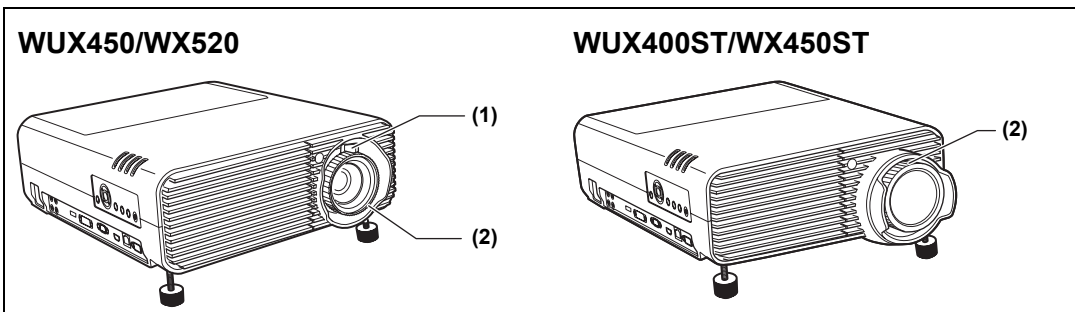

- (1) **Optical zoom adjustment (WUX450/WX520)**  
Move the lever to resize the image. (P57)
- (2) **Focus adjustment**  
Turn the focus ring to adjust image focus. (P59)

# Open Source Software

The product contains Open Source Software modules. For details, see “ThirdPartySoftware.pdf” (Third-Party Software License) in the OpenSourceSoftware folder in the LICENSE folder on the Setup CD-ROM. Each module’s license conditions are also available in the same folder.

## ■ Software under the GPL and LGPL

The product includes modules licensed under the GPL and LGPL. Source code can be examined in the GPL and LGPL folders on the supplied Setup CD-ROM.

## ■ Software under the GNU General Public License Version 2

Contained programs are free software; you can redistribute them and/or modify them under the terms of the GNU General Public License attached to each copy of the program.

Each program is distributed in the hope that it will be useful, but WITHOUT ANY WARRANTY; without even the implied warranty of MERCHANTABILITY or FITNESS FOR A PARTICULAR PURPOSE. Please see “NO WARRANTY” and “NO SUPPORT” stated below. For more detail, please see full text of the GNU General Public License.

### **NO WARRANTY**

BECAUSE THE PROGRAM IS LICENSED FREE OF CHARGE, THERE IS NO WARRANTY FOR THE PROGRAM, TO THE EXTENT PERMITTED BY APPLICABLE LAW. EXCEPT WHEN OTHERWISE STATED IN WRITING THE COPYRIGHT HOLDERS AND/OR OTHER PARTIES PROVIDE THE PROGRAM “AS IS” WITHOUT WARRANTY OF ANY KIND, EITHER EXPRESSED OR IMPLIED, INCLUDING, BUT NOT LIMITED TO, THE IMPLIED WARRANTIES OF MERCHANTABILITY AND FITNESS FOR A PARTICULAR PURPOSE. THE ENTIRE RISK AS TO THE QUALITY AND PERFORMANCE OF THE PROGRAM IS WITH YOU. SHOULD THE PROGRAM PROVE DEFECTIVE, YOU ASSUME THE COST OF ALL NECESSARY SERVICING, REPAIR OR CORRECTION.

IN NO EVENT UNLESS REQUIRED BY APPLICABLE LAW OR AGREED TO IN WRITING WILL ANY COPYRIGHT HOLDER, OR ANY OTHER PARTY WHO MAY MODIFY AND/OR REDISTRIBUTE THE PROGRAM AS PERMITTED ABOVE, BE LIABLE TO YOU FOR DAMAGES, INCLUDING ANY GENERAL, SPECIAL, INCIDENTAL OR CONSEQUENTIAL DAMAGES ARISING OUT OF THE USE OR INABILITY TO USE THE PROGRAM (INCLUDING BUT NOT LIMITED TO LOSS OF DATA OR DATA BEING RENDERED INACCURATE OR LOSSES SUSTAINED BY YOU OR THIRD PARTIES OR A FAILURE OF THE PROGRAM TO OPERATE WITH ANY OTHER PROGRAMS), EVEN IF SUCH HOLDER OR OTHER PARTY HAS BEEN ADVISED OF THE POSSIBILITY OF SUCH DAMAGES.

**NO SUPPORT**

Canon Inc., and all its subsidiaries or its dealers do not make any support service regarding the source code. Canon Inc., and all its subsidiaries or its dealers shall not respond to any questions or enquiries, from you or any other customers, regarding the source code.





MULTIMEDIA PROJECTOR

**WUX450**

**WX520**

**WUX400ST**

**WX450ST**

# Operation





# Projecting an Image

Table of Contents

Safety Instructions

Before Use

Projecting an Image

Operation

Useful Functions Available  
During a Presentation

Setting Functions from  
Menus

Installation and Maintenance

Installation

Connecting to a Network

Maintenance

Networked Multi-Projection

Networked Multi-Projection  
Overview

Operation in Each Mode

Functions in All Modes

Appendix

Other Information

Index

# Step 1 Turn the Projector On

## 1 Check the connection between the projector and the computer or AV equipment. (P137 - P140)

For instructions on connecting the power cord, refer to “Plugging the Projector In” (P143).

## 2 Press the POWER button.

The [POWER ON] indicator initially flashes green, after which it remains lit.

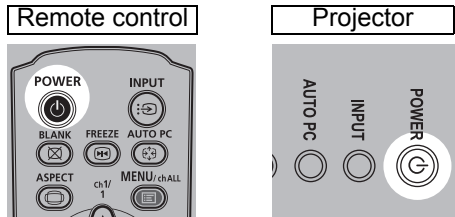

The countdown window is displayed for approximately 20 seconds, and then the projection is started. Press the **OK** or **EXIT** button to make the countdown window disappear.



- Network functions are not available for the first 40 seconds after startup.
- A window appears when the projector is turned on for the first time. You can select a language to be used by the projector for displaying menus and messages in the window. Select the desired language with the pointer buttons and press the **OK** button. (P144)  
You can change the language from the menu at a later time. (P115)
- If the language selection screen is out of focus, adjust the focus. (P59)

## 3 Turn on the computer or AV equipment power.

### Changing Operations When Projector is Turned On

You can change operations when the projector is turned on as follows.

- You can turn on the projector by connecting the power cord, without pressing the **POWER** button. (P111)
- You can change the countdown window. (P110)
- You can skip the countdown window. (P110)

### When the Projector Is Left Idle

If no signal is received, the projector automatically turns off after a certain period of inactivity (by default, 15 minutes). (P110)











## Step 2 Select an Input Signal

Select the input signal in the [Input] menu when you want to project a digital PC or AV equipment signal, or to switch between inputs when multiple computers or multiple sets of AV equipment are connected.

Skip this step if you have not changed the input signal since the last projection.

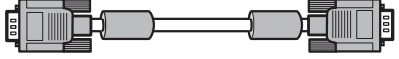
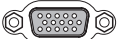
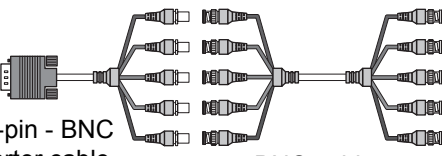
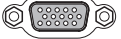
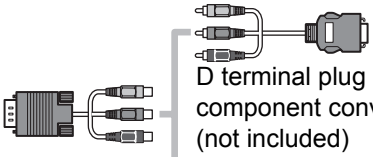
### Types of Input Signals

The table below shows the relationship among input signals supported by the projector, input terminals and connection cables.

Input signal	Input terminal	Types of connection cables
<b>HDMI</b>	 HDMI	HDMI cable (not included) 
<b>Digital PC</b>	 1 DVI-I	DVI cable (not included) 
<b>Analog PC-1</b>	 1 DVI-I	VGA-DVI cable (not included) 
<b>Analog PC-2</b>	 2/COMPONENT	Computer cable (supplied) 
	 2/COMPONENT	BNC cable (not included)  Mini D-sub 15-pin - BNC terminal converter cable (not included)
<b>Component</b>	 2/COMPONENT	Component cable (not included)  D terminal plug - RCA plug component conversion cable (not included) RCA plug - RCA plug component cable (not included)
<b>LAN</b>	 LAN	LAN cable (shielded twisted pair) (not included) 
<b>USB</b>	 USB	Connect a USB flash drive. (P79)

# Selecting an Input Signal

**1** Press the **INPUT** button to display the window shown below.

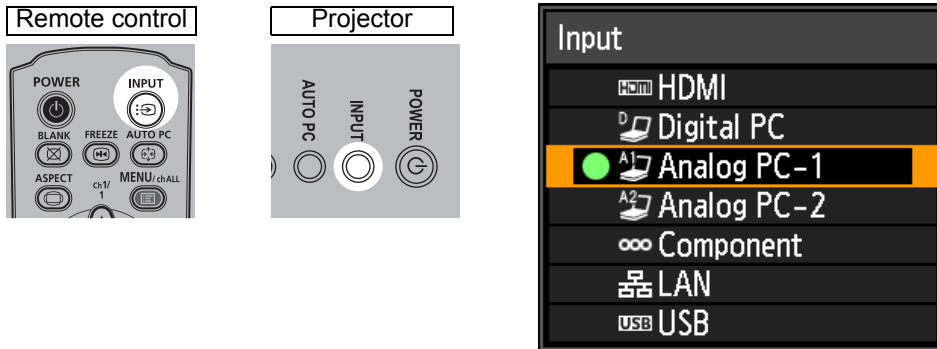

The currently active input signal is marked with a green circle and enclosed by an orange border.

An input signal that is ready for projection is displayed in white. When no signal is received, it is displayed in gray. However, [Digital PC] or [Analog PC-1] may be displayed in gray even if these signals are ready for projection.

**2** You can switch the available input signal types by pressing the **INPUT** button.

- You can select the target input signal with [▲] / [▼].

**3** Press the **OK** button to confirm the input signal type.



- Screens of computers connected to the projector over a network can be projected when you have selected [LAN] as the input signal. For details, refer to Networked Multi-Projection (NMPJ).
- Images on USB flash drives can be projected when you have selected [USB] as the input signal. For details, refer to “Projecting Images on a USB Flash Drive” (P79).
- In split-screen mode, the side without control rights is identified by a white circle.

## Step 3 Adjust the Image

# Setting the Display Resolution of the Computer

Based on the maximum resolution of the projector, set the display resolution of the computer to the resolution closest to the output signal resolution of the projector. (P292)

### Maximum resolution

**WUX450/WUX400ST** : 1920 X 1200 dots

**WX520/WX450ST** : 1440 X 900 dots

### ■ Windows 8

- 1 Move the cursor toward the upper or lower right corner to access the menu.
- 2 Click [Settings], and then click [Control Panel].
- 3 From [Control Panel Home] - [Appearance and Personalization], select [Adjust screen resolution].
- 4 Select the resolution closest to the maximum output signal resolution of the projector from the [Resolution] list.
- 5 Click the [OK] button.

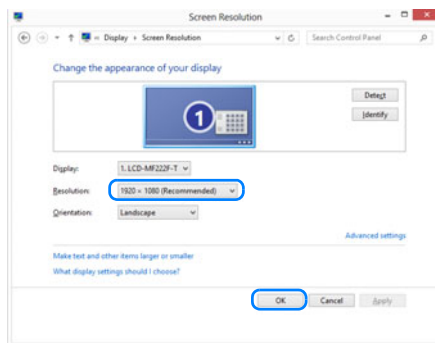

### ■ Windows 7

- 1 Open the [Control Panel] from the start menu, then select [Appearance and Personalization] - [Adjust screen resolution] in the [Control Panel Home].
- 2 Click the [Resolution] tab, and move the slider to select the resolution closest to the maximum output signal resolution of the projector.
- 3 Click the [OK] button.

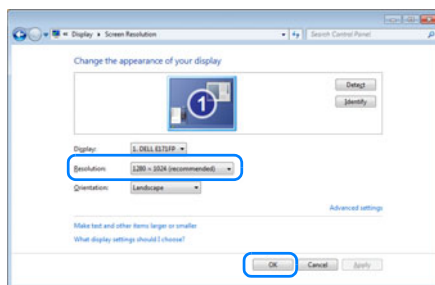

## Step 3 Adjust the Image

### ■ Windows Vista

- 1 Open the [Control Panel] from the start menu, then select [Appearance and Personalization] - [Adjust screen resolution] in the [Control Panel Home].
- 2 Under [Resolution], use the slider to select the resolution closest to the projector's maximum resolution.
- 3 Click the [OK] button.

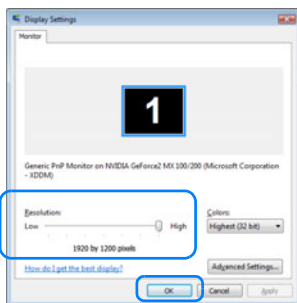

### ■ Windows XP

- 1 Right-click on the desktop background and select [Properties] to open the [Display Properties].
- 2 Click the [Settings] tab, and under [Screen resolution], use the slider to select the resolution closest to the projector's maximum resolution.
- 3 Click the [OK] button.



### ■ Mac OS X

- 1 Open the Apple Menu and select [System Preferences].
- 2 In the [System Preferences] window, click the [Displays] icon to display the Display window.
- 3 Select the [Display] tab and select the resolution closest to the maximum output signal resolution of the projector from the [Resolutions] list.
- 4 Close the [System Preferences] window.

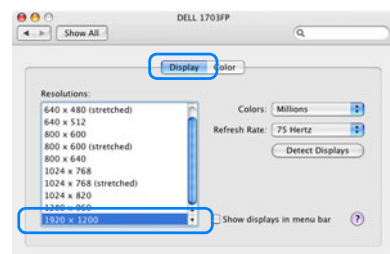



## Auto PC Adjustment

If the image display is shifted or there is flickering of the screen when [Analog PC-1] or [Analog PC-2] is selected, press the **AUTO PC** button to adjust the projector to the optimal condition.

The adjustment results will be stored. If the projector is used again with the same computer, when the input signal is selected the image will be projected automatically under the same conditions that were previously adjusted.

### ■ Performing the Auto PC Function

Press the **AUTO PC** button to perform projector adjustment.

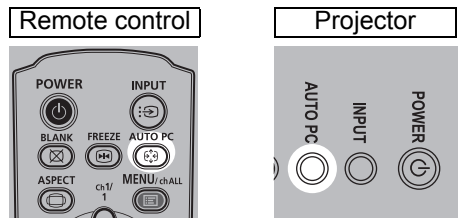

If the Auto PC adjustment is insufficient, perform the following operations.

- Select the input signal that matches the resolution of the computer from [Input signal select]. (P88)
- If adjustment is insufficient even when using the above operation, adjust [Total dots], [Tracking], [Horizontal position], [Vertical position], [Horizontal pixels] and [Vertical pixels] in [Input signal settings]. (P89 - P91)
- For the signal types supported by the projector, see the table on [page 292](#).

## Adjusting the Image Size (WUX450/WX520)

To adjust the image size, turn the lever on the projection lens. Change the projector installation position (P130) if your desired image is too large or too small to adjust it with the zoom function.

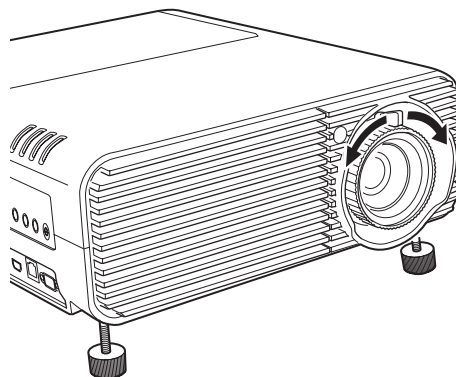

## Adjusting the Image Position

Turn the lens shift dials to adjust the projected image vertically or horizontally. Called “lens shift,” this adjusts the projected image into position by moving the lens up, down, left, or right.



- Instead of adjusting where the image is projected, you can also move the image itself. For details, refer to “Specifying Digital Image Shift” (P150).
- You can fine-tune the image position by turning the upper part of the upper lens shift dial or the lower part of the lower lens shift dial.

### ■ WUX450/WX520

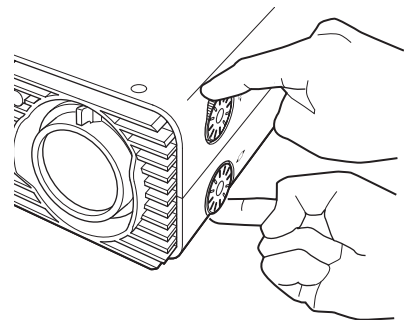
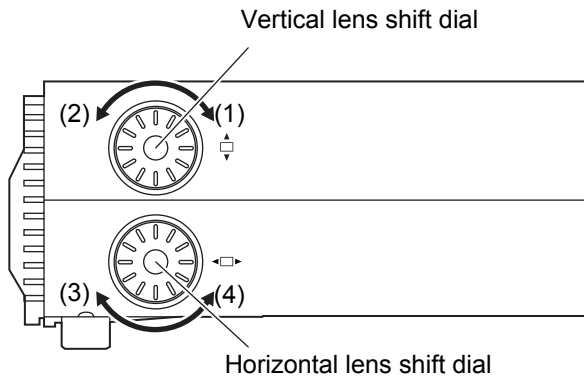

- |   |                                |
|---|--------------------------------|
| (1) Turning upper lens shift dial clockwise:        | Moves the image <b>down</b> .  |
| (2) Turning upper lens shift dial counterclockwise: | Moves the image <b>up</b> .    |
| (3) Turning lower lens shift dial clockwise:        | Moves the image <b>left</b> .  |
| (4) Turning lower lens shift dial counterclockwise: | Moves the image <b>right</b> . |
- For details on lens shift, refer to “Lens Shift Function” (P134).

### ■ WUX400ST/WX450ST

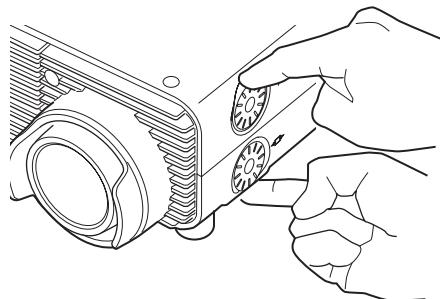
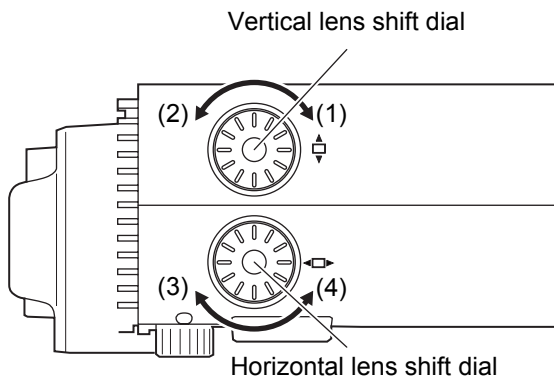

- |   |                                |
|---|--------------------------------|
| (1) Turning upper lens shift dial clockwise:        | Moves the image <b>up</b> .    |
| (2) Turning upper lens shift dial counterclockwise: | Moves the image <b>down</b> .  |
| (3) Turning lower lens shift dial clockwise:        | Moves the image <b>right</b> . |
| (4) Turning lower lens shift dial counterclockwise: | Moves the image <b>left</b> .  |
- For details on lens shift, refer to “Lens Shift Function” (P134).

## Adjusting the Focus

To adjust the focus, turn the focus ring.

### WUX450/WX520

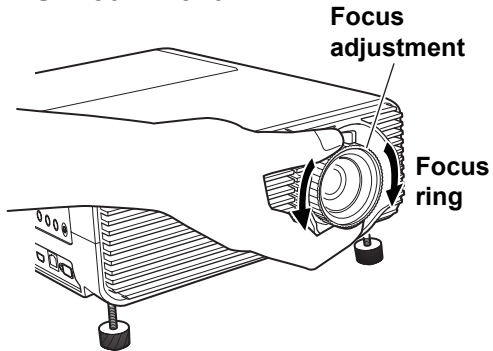

### WUX400ST/WX450ST

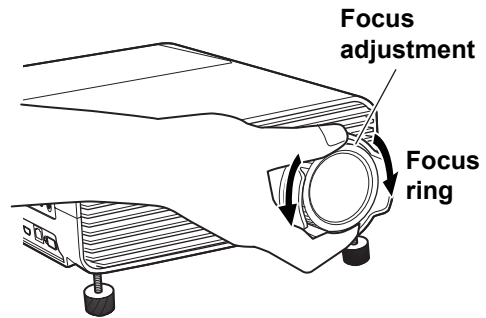

On the WUX400ST/WX450ST, images will waver as you turn the focus ring. Hold the focus ring on top and bottom and turn it slowly as you adjust the focus.

## Step 4 Select an Aspect Ratio (Screen Aspect) Matching the Screen

Select an optimum aspect ratio of the projected image (screen aspect) or an optimum screen mode (aspect) according to the aspect ratio of the screen, type of input image signal and so on for the projection to make best use of the screen size.

**[Screen aspect]** Select the same screen aspect ratio as the screen you are using.

**[Aspect]** In general, select [Auto].

You may need to change the setting depending on the resolution of the computer or other AV equipment connected. If the image is not projected with the desired aspect ratio, refer to “Relationship between Aspect and Screen Aspect” on [page 287](#).

## Selecting Screen Aspect

Select the correct aspect ratio for the screen which is used.

### 1 Press the MENU button to display the menu window.

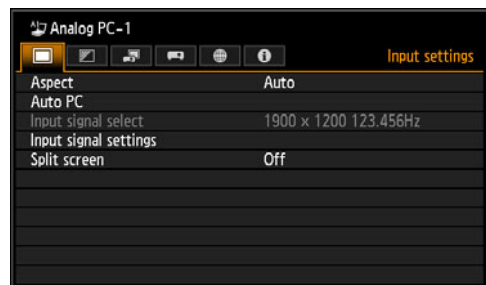
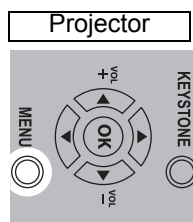
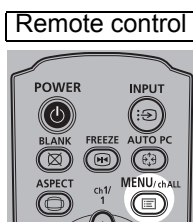

### 2 Press the [◀] / [▶] buttons to select the [Install settings] tab.

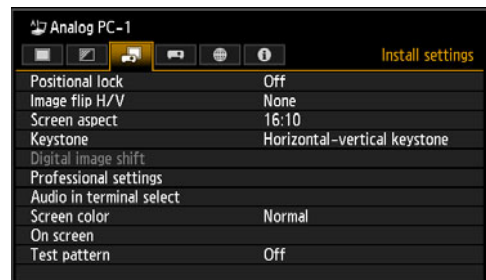
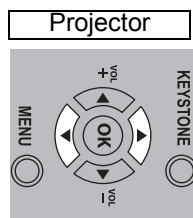
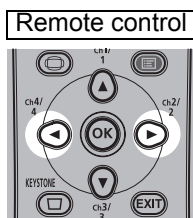

## Step 4 Select an Aspect Ratio (Screen Aspect) Matching the Screen

- 3** Select [Screen aspect] with the [▲] / [▼] buttons, and then press the OK button.

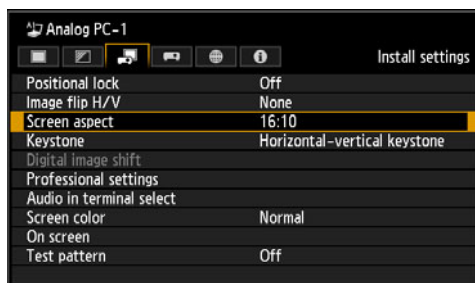
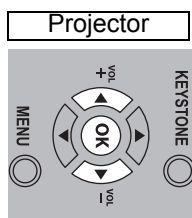
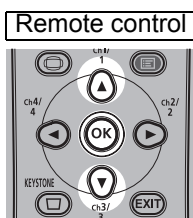

- 4** Use the [▲] / [▼] buttons to select the desired contents.

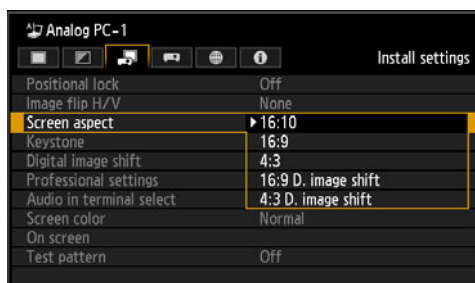
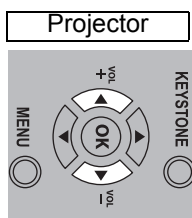
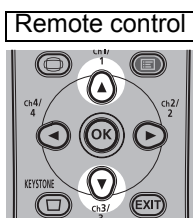

### 16:10

Select this when you use a screen with an aspect ratio of 16:10. Also select this screen aspect when projecting on a wall.

You can correct keystone distortion with this mode. (P68)



16:10 screen

### 16:9

Select this when you use a screen with an aspect ratio of 16:9.

You can correct keystone distortion with this mode. (P68)



16:9 screen

### 4:3

Select this when you use a screen with an aspect ratio of 4:3.

You can correct keystone distortion with this mode. (P68)



4:3 screen

## Step 4 Select an Aspect Ratio (Screen Aspect) Matching the Screen

### **16:9 D. image shift**

Select this when you use a screen with an aspect ratio of 16:9.

Keystone correction cannot be performed in this mode. However, it is possible to move the image up / down when projecting level.

For details about how to move the image, refer to [page 63](#).

### **4:3 D. image shift**

Select this when you use a screen with an aspect ratio of 4:3.

Keystone correction cannot be performed in this mode. However, it is possible to move the image left / right when projecting level.

For details about how to move the image, refer to [page 64](#).

**5 Press the OK button to accept your setting and then press the MENU button.**

## Moving Image with 16:9 D. Image Shift

This option applies image processing to reposition the image. For this reason, it is called digital image shift.

- 1 When the screen aspect is [16:9 D. image shift], press the MENU button to display the menu.

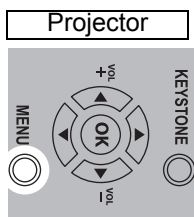

- 2 Press the [◀] / [▶] buttons to select the [Install settings] tab.

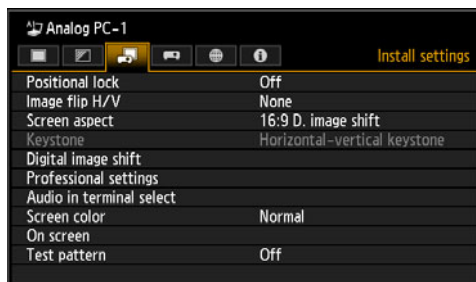
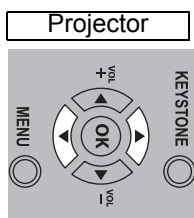
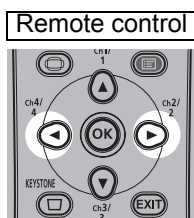

- 3 Use the [▲] / [▼] buttons to select [Digital image shift], then press the OK button.

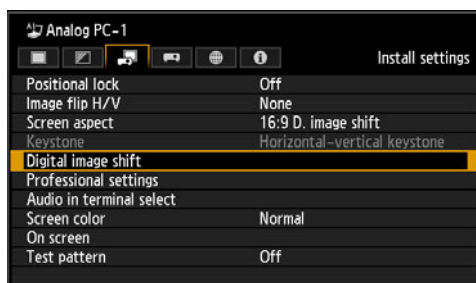
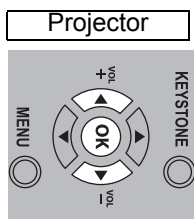
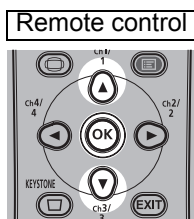

## Step 4 Select an Aspect Ratio (Screen Aspect) Matching the Screen

4 Use the [▼] / [▲] buttons to move the image up or down.

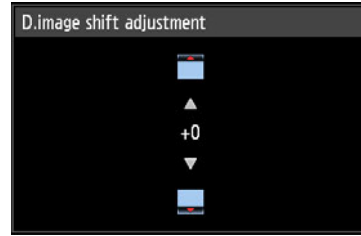
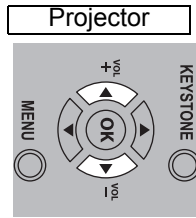
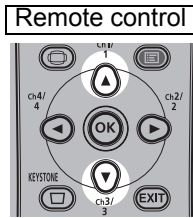

[▲] button  
Moves the image up.

[▼] button  
Moves the image down.



Screen

5 When the image fits the screen, press the OK button.

## Moving Image with 4:3 D. Image Shift

1 When the screen aspect is [4:3 D. image shift], press the MENU button to display the menu.

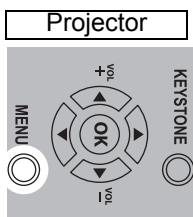

2 Press the [◀] / [▶] buttons to select the [Install settings] tab.

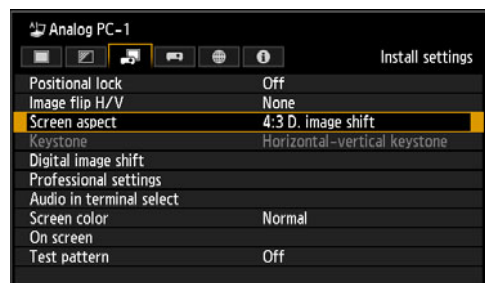
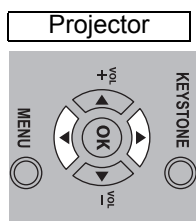
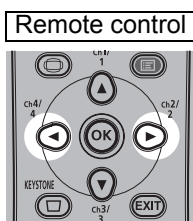



## Step 4 Select an Aspect Ratio (Screen Aspect) Matching the Screen

- 3 Use the [▲] / [▼] buttons to select [Digital image shift], then press the OK button.

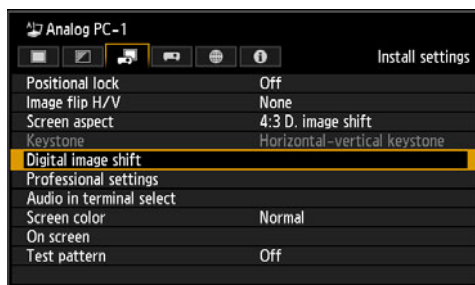
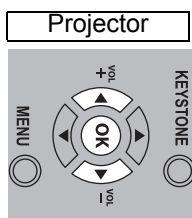
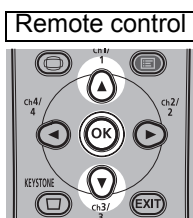

- 4 Use the [◀] / [▶] buttons to move the image.

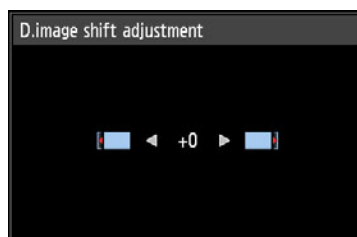
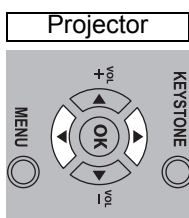
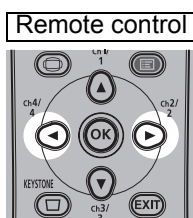

**[▶] button**  
Moves the image right.

**[◀] button**  
Moves the image left.



- 5 When the image fits the screen, press the OK button.

## Resetting the Image Shift

Perform the following steps to reset the image shift adjustment.

Access the [D. image shift adjustment] window and press the **KEYSTONE** button to display the [D. image shift reset] window.

Next, select [OK] with the [◀] button, and then press the **OK** button.

# Selecting the Aspect

Select [Aspect] based on the input signal type, aspect ratio of the screen and resolution.

For more details about aspect ratios, refer to “Relationship between Aspect and Screen Aspect” on [page 287](#).

## Types of Aspect Ratios

### Auto

An image is projected at the aspect ratio of the input signal. Select this mode for normal image projection.

### 16:10

The image is projected using an input signal aspect ratio of 16:10. Select this if an image of 16:10 aspect ratio cannot be correctly projected in [Auto] mode.

### 16:9

The image is projected using an input signal aspect ratio of 16:9. Select this if an image of 16:9 aspect ratio cannot be correctly projected in [Auto] mode.

### 4:3

The image is projected using an input signal aspect ratio of 4:3. Select this if an image of 4:3 aspect ratio cannot be correctly projected in [Auto] mode.

### Zoom

This cuts the upper/lower or left/right part of the screen according to the screen aspect and zooms in or out of the center of the image. Select this if a letter box is displayed (black lines at the top/bottom of the screen) when watching video.



There may be some cases when this cannot be selected, depending on the input signal and/or resolution.

### True size

The image is projected with the original resolution of the input signal. Select this option for clear projection of computer screens at up to maximum resolution.



There may be some cases when this cannot be selected, depending on the input signal and/or resolution.

## Selecting an Aspect Ratio

Press the **ASPECT** button on the remote control and select an appropriate aspect ratio. Press the **ASPECT** button to change the aspect ratio type. For more details about aspect ratios, refer to “Relationship between Aspect and Screen Aspect” on [page 287](#).

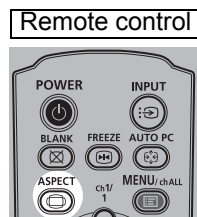

Example:



You can also select any aspect ratio from [Aspect] in the menu. (P87)



Some aspect ratios may not appear depending on the type of input signal.

## Step 5 Correct the Image Distortion

### Adjusting Keystone Distortion

To correct keystone distortion, press the **KEYSTONE** button.

Two types of correction are available: horizontal/vertical correction and corner correction.

Horizontal/vertical keystone correction adjusts image width and height, and corner correction adjusts the image relative to each corner.

For instructions on switching between the two types of keystone correction, refer to “Specifying Keystone Correction” (P150). Press the **KEYSTONE** button to correct distortion according to the selected keystone correction method.



- Keystone can be adjusted within a range of approximately  $\pm 20^\circ$  (WUX450/WX520) or approximately  $\pm 12^\circ$  (WUX400ST/WX450ST). If the keystone distortion is too large to adjust, move the projector installation position so that it is completely straight.
- The result of keystone adjustment is stored in memory. If you place the projector in the same position, the keystone adjustment is not necessary.
- Signals are processed digitally when keystone distortion is corrected. The image may look different from the original one. In addition, the aspect ratio of the image may change.
- Keystone correction may not be effective in some lens shift positions.
- The digital image shift function (P63) is accessed when this button is pressed and the screen aspect is [4:3 D. image shift] or [16:9 D. image shift].

### ■ Horizontal/Vertical Keystone Correction



[Zoom] (P149) in the [Install settings] menu is not available during horizontal/vertical keystone correction (WUX400ST/WX450ST).

- 1 Press either the **KEYSTONE** button on the remote control or the **KEYSTONE** button on the projector to display the window shown below.

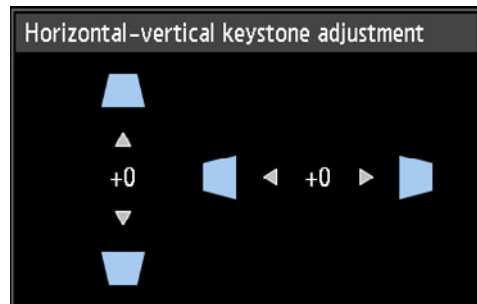
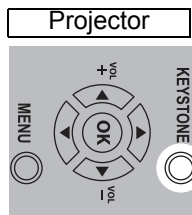
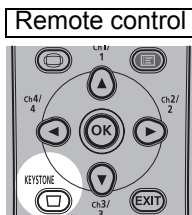

**2 Press the pointer buttons to adjust the dimensions.**

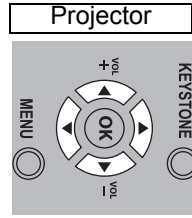
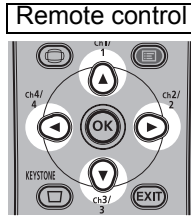

**[▲] button**  
Reduces the dimensions of the upper edge.

**[▼] button**  
Reduces the dimensions of the lower edge.

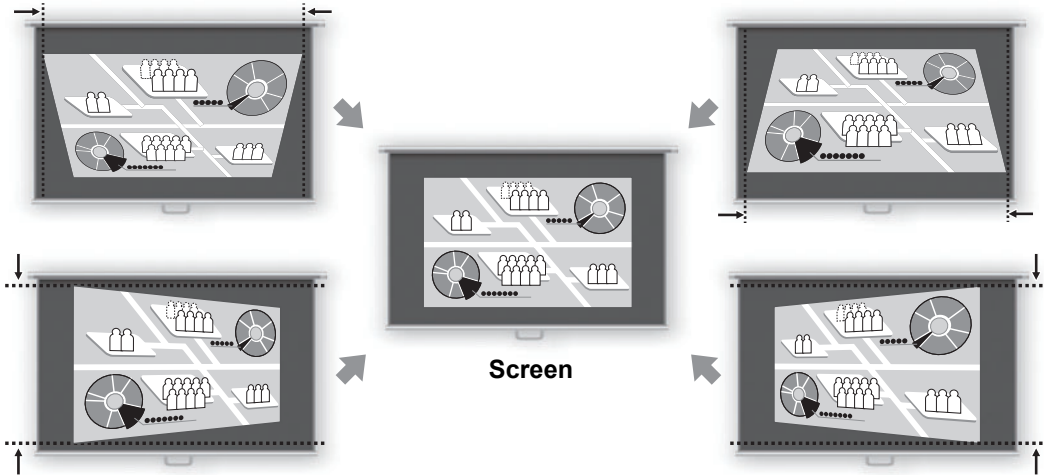

**[◀] button**  
Reduces the dimension of the left edge.

**[▶] button**  
Reduces the dimension of the right edge.

**3 When keystone distortion has been corrected, press the OK button.**

**■ Corner Adjustment**

**1 Press either the KEystone button on the remote control or the KEystone button on the projector in order to display the window shown below on the right.**

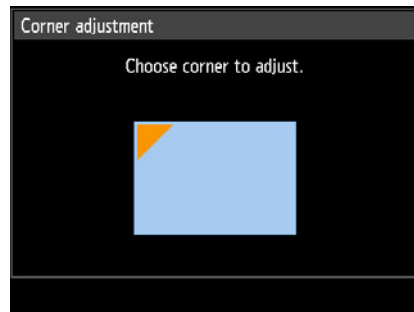
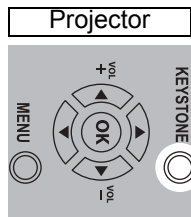
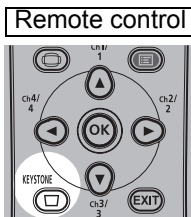

## Step 5 Correct the Image Distortion

- 2 Press the pointer button of the corner for correction, and then press the OK button.**

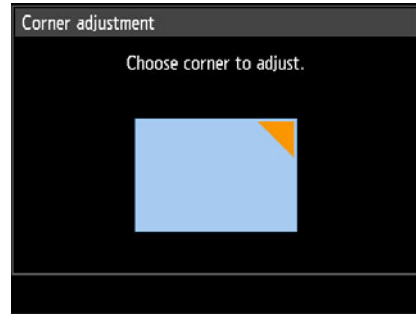
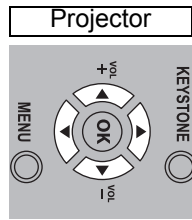
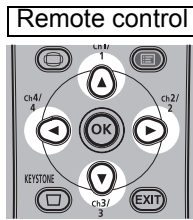

- 3 Press the pointer buttons to adjust the corner.**

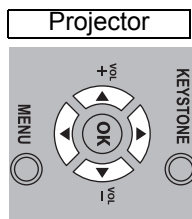
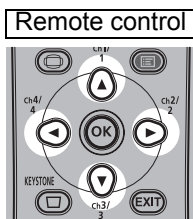

- 4 When you have finished correcting, press the OK button.**



Corner adjustment settings will be cleared if you subsequently use [Zoom] (P149) in the [Install settings] menu (WUX400ST/WX450ST).

### ■ Resetting the Keystone Adjustment

Perform the following steps to reset the keystone adjustment.

Press the **KEYSTONE** button twice to display the [Keystone reset] window. You can now reset the correction selected in the keystone setting.

Next, select [OK] with the [**◀**] button, and then press the **OK** button.

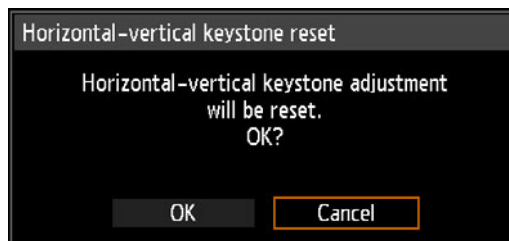

## Step 6 Select the Image Quality (Image Mode)

You can select an image mode to suit the projected image.

In each image mode, you can further adjust the brightness, contrast, sharpness, gamma, color adjustment, advanced adjustment, and lamp mode. (P97)

### Image Modes

The image modes which can be selected vary somewhat depending on the selected input signal.

Image Mode	Compatible input signals		Explanation
	Digital PC Analog PC-1 / 2 HDMI (when [HDMI In] is [Computer]) LAN USB	Component HDMI (when [HDMI In] is [Auto])	
Standard	○	—	Suitable for projecting a computer screen or watching video in a brightish room. This image mode emphasizes white tones.
Presentation	○	—	Suitable for viewing text-based images in a brightish room.
Dynamic	—	○	Suitable for watching video in a brightish room.
Photo/sRGB	○	○	Suitable for viewing images from sRGB-compatible digital cameras or Blu-ray videos in a moderately dark room. Compatible with the sRGB color space.
Video	—	○	Suitable for watching video taken with a video camera in a moderately dark room.
User 1 - 5	○	○	Up to 5 user-selected combinations of image quality settings can be stored in the memory. (P98) Stored settings can be selected as an image mode.

○: Compatible —: Not compatible

## Step 6 Select the Image Quality (Image Mode)

### ■ Selecting an Image Mode

Press the **IMAGE** button on the remote control to select.

The image mode changes each time the **IMAGE** button is pressed. (The displayed image modes vary depending on the selected input signal.)

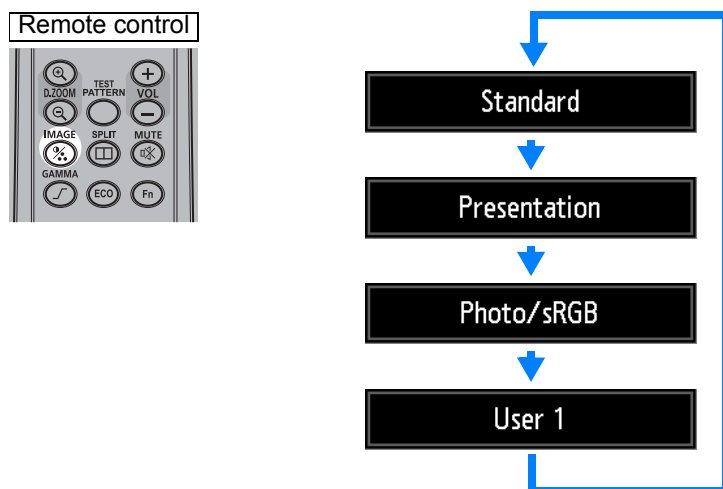

You can also select any image mode from the [Image mode] menu. (P97)

- User settings 1 - 5 are displayed when the desired image settings have been created and stored using the user memory function in the image adjustment menu (P98).



# Step 7 Set Power-Saving Settings

Press the **ECO** button on the remote control to complete power-saving settings. The following three settings are available.

- **Lamp Settings**

For changing lamp and fan power consumption in the current image mode.

- **Auto Power-Off**

A function for automatically turning the power off after a certain period if the projector is not used and there is no input signal.

- **Network Standby Settings**

Specify whether network functions should be active in standby mode.

**1** Press the **ECO** button to display the window shown below.

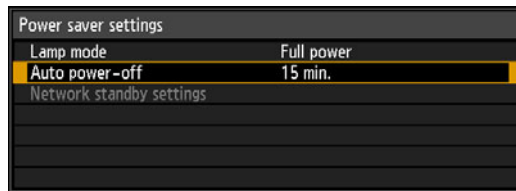

**2** Press the **[▲]** / **[▼]** buttons to select a menu.

Complete the setting for the selected function. For details, refer to the page describing each function.

- Lamp Settings ([P107](#))
- Auto Power-Off ([P110](#))
- Network Standby Settings ([P172](#))

# Step 8 Turn the Projector Off

**1** Press the **POWER** button to display the window shown below.

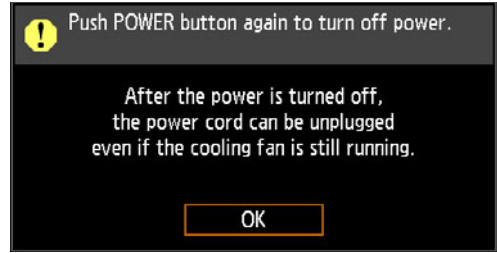
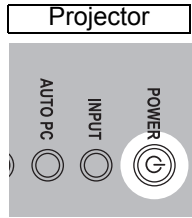
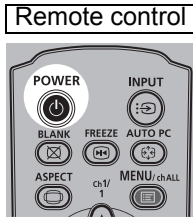

**2** When this window is displayed, press the **POWER** button again to turn off the power.

After you turn the power off, the projector will enter standby mode once it cools down.



If you want to continue projecting without turning off the power, press a button other than **POWER**, or else wait until the confirmation message disappears.



- After turning off the projector, wait at least 5 minutes before turning it on again. It may shorten the lamp life if you turn on the projector immediately after turning it off.
- Using the projector for a long time may shorten the life of the lamp and internal optical components.
- Unplug the projector if it will not be used for an extended period.

# Useful Functions Available During a Presentation

Table of Contents

Safety Instructions

Before Use

## Operation

Projecting an Image

Useful Functions Available During a Presentation

Setting Functions from Menus

## Installation and Maintenance

Installation

Connecting to a Network

Maintenance

## Networked Multi-Projection

Networked Multi-Projection Overview

Operation in Each Mode

Functions in All Modes

## Appendix

Other Information

Index

## Temporarily Blacking Out an Image

Useful when:

- You have finished the presentation.
- You want to divert attendees' attention from the screen.

Remote control

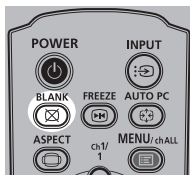

Press the **BLANK** button to black out the image.

Press the **BLANK** button again to show the image.

- You can set the screen state while blacking out the image in the menu. (P109)
- The lamp remains illuminated while the image is blacked out.

## Freezing the Picture

Useful when:

- You want to perform a computer operation which is irrelevant to the proceedings of the presentation.
- You want to stop a moving image.

Remote control

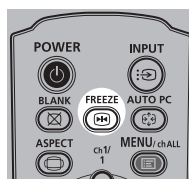

Press the **FREEZE** button to freeze the moving image. The projector shows the following icon.

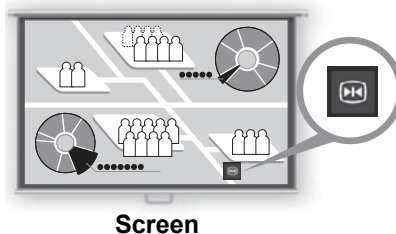

Screen

Press the **FREEZE** button again to return to the original display.

- It is also cancelled when the input signal is terminated.

## Adjusting the Volume

### Useful when:

- You want to adjust the volume level of the projector or external speakers.

#### Remote control

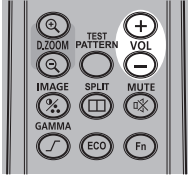

Press the **VOL** button. The following screen appears.



- You can also adjust the volume level with the [▲] / [▼] buttons of the projector.
- Adjust the volume or mute setting on the computer if the volume level is too low.
- You can also adjust the volume level of the speakers connected via the audio output terminal.

## Muting the Sound

### Useful when:

- You want to temporarily mute unnecessary sound.
- You want to immediately mute the sound.

#### Remote control

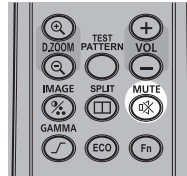

Press the **MUTE** button to mute the sound. The projector shows the following icon.

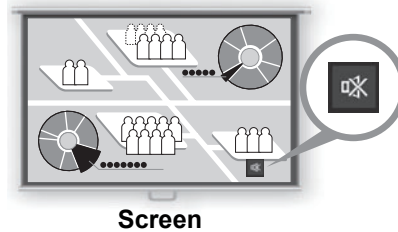

Screen

Press the **MUTE** button again to cancel the mute function.

- You can also mute the sound of the speakers connected via the audio output terminal.

## Zooming an Image

Useful when:

- Zooming in on an object such as a small graph during a presentation (up to 12x).
- Focusing on the current subject.

Press the **+ D.ZOOM** button to enlarge a part of the image. Press the **- D.ZOOM** button to reduce the image size.

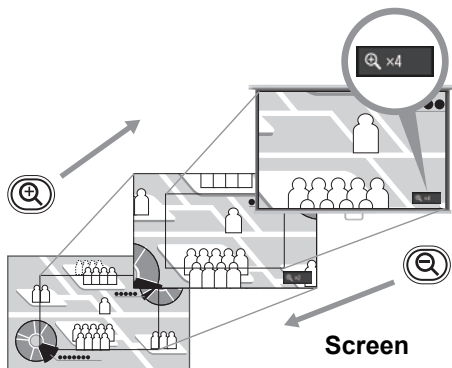
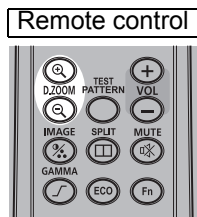

- The magnification appears on the screen.

You can move the enlarged area by using the [▲] / [▼] / [◀] / [▶] buttons.

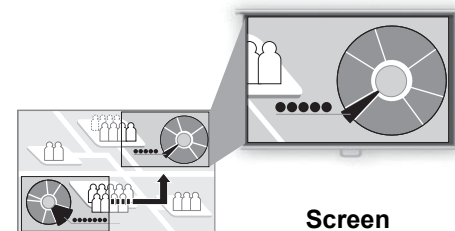
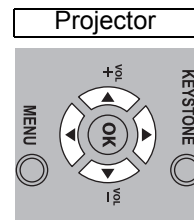
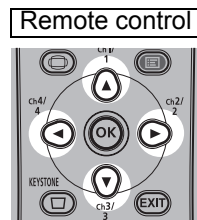

Screen

You can restore the original size of the image by pressing the **OK** button.



The **D.ZOOM** buttons work differently than [Zoom] in the WUX400ST/WX450ST [Install settings] menu (P149).

# Projecting Images on a USB Flash Drive

Images stored on a USB flash drive in the projector can be projected as follows. You can select the images to project, or you can project images automatically, one after another. JPEG images up to 7000x7000 can be projected.



- USB flash drives with security features are not recognized by the projector and cannot be selected as the image source.
- If the projector cannot mount the file system, the drive name is grayed out and the following icon is displayed. In this case, the USB flash drive cannot be used.

 USB1 USB CARD1

## 1 Insert the USB flash drive in the USB port.

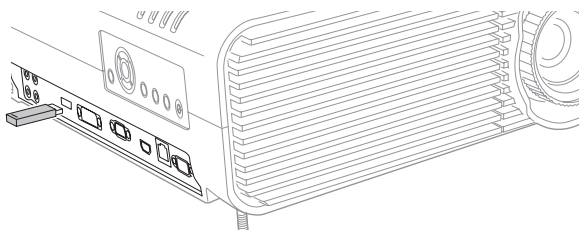

Insert the USB flash drive directly into the projector's USB port. The USB flash drive will not be recognized if you connect it via a hub.

## 2 Press the INPUT button.

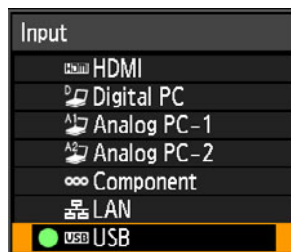
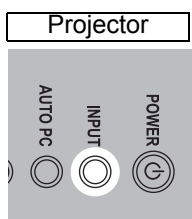
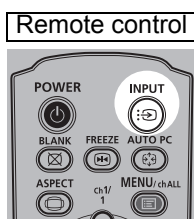

## 3 Press the INPUT button repeatedly to select [USB].

JPEG files on the USB flash drive are now listed.

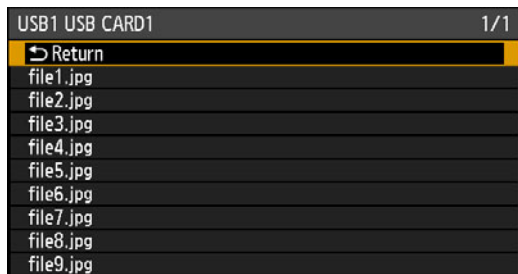

- If the USB flash drive contains multiple partitions, a screen is displayed for you to select the desired partition. Use the pointer buttons to select the partition, and then press the **OK** button. Files on the partition are now listed.
- Enlargement with the **D.ZOOM** button and split-screen display are not available when [USB] is selected as the input signal.

### 4 Use the pointer buttons to select a file, and then press the OK button to project the image.

Press the [▲] / [▼] buttons to select a file.

To view another page, press the [◀] / [▶] buttons (if other pages are available).

To navigate to a higher or lower folder, select a folder and press the **OK** button.



Motion blur reduction is not available when projecting JPEG files on a USB flash drive. (P114)

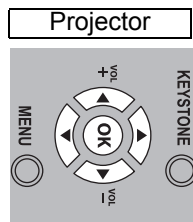
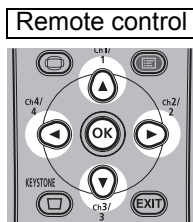

### 5 Switch to other images as needed.

To switch to the previous image, press the [▲] button.

To switch to the next image, press the [▼] button.

To rotate images left 90°, press the [◀] button.

To rotate images right 90°, press the [▶] button.

### 6 After projection is finished, remove the USB flash drive.



The projector can also play a slideshow of images on a USB flash drive automatically. (P94)



# Split-Screen Display

Two input images can be projected side by side. This is split-screen display. When you activate split-screen display, the current image is shown on the left side, and the new image is shown at right. You can change the source of images shown on each side by pressing the **INPUT** button. However, you cannot specify the same input signal (terminal) as the source for both sides.



- Network and USB input cannot be combined with other types of input for split-screen display.
- [Zoom] (P149) in the [Install settings] menu is not available in split-screen mode (WUX400ST/WX450ST).

- 1 Supply two signals to the projector.**
- 2 Press the SPLIT button on the remote control.**

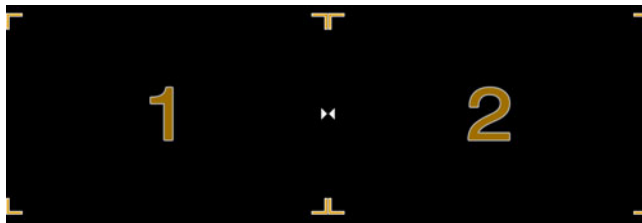

- A number is displayed in the center of one image area. (1 applies to the left image and 2 to the right image.) The image labeled with a number has “control rights,” and the sound for that image will be played. This is also the image with control rights if you adjust [Image priority]. (P96)
- The number is no longer displayed after a little while, but you can view it again by pressing the **SPLIT** button.
- To exit split-screen display, press the **EXIT** button.
- Split-screen display can also be accessed by selecting [Split screen] in the [Input settings] menu. (P95)
- These functions cannot be adjusted in this mode: sharpness (P100), dynamic gamma (P103), and motion blur reduction (P114).
- Some functions are not available, such as [Image flip H/V] (P146), [Screen aspect] (P148), [Keystone] (P150), and [Logo capture] (P108).
- Image mode colors differ somewhat from those in single-image mode.

## Split-Screen Display

- 3 If ▷ or ◁ is displayed in the center of the image area, you can switch control to the other side by pressing the [◀] / [▶] buttons on the remote control.

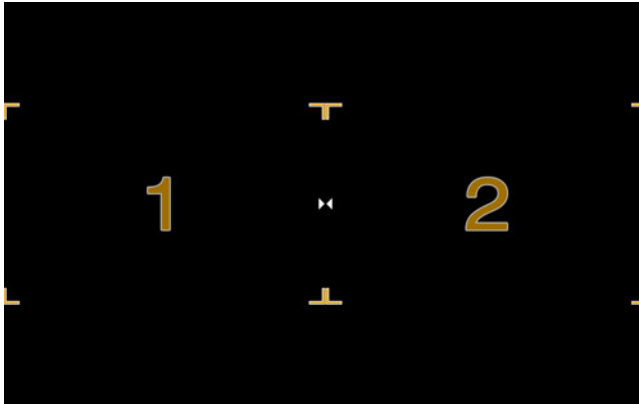

(Example of display in split-screen mode.)

- 4 Press the INPUT button to select the input signal for the side with control rights.

The [Input] menu is displayed. To determine which side is currently under control, check the screen ID in orange in the upper right of the menu. The side without control rights is labeled with a white circle.

For details on selecting input signals, refer to “Selecting an Input Signal” (P54).

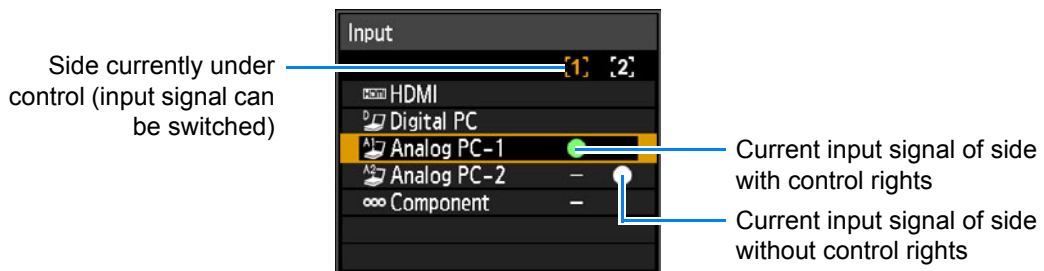

To exit split-screen display, press the **EXIT** button on the remote control.

# Setting Functions from Menus

Table of Contents

Safety Instructions

Before Use

## Operation

Projecting an Image

Useful Functions Available During a Presentation

**Setting Functions from Menus**

## Installation and Maintenance

Installation

Connecting to a Network

Maintenance

## Networked Multi-Projection

Networked Multi-Projection Overview

Operation in Each Mode

Functions in All Modes

## Appendix

Other Information

Index

# Using Menus

Use the menus to set the operation of the projector in detail.

## Menu Configuration

The menu screen is divided into 6 tabs as shown below.

**[Install settings] tab**  
This setting is used when installing the projector.

**[Image adjustment] tab**  
You can adjust the image quality and colors according to your preference.

**[Input settings] tab**  
You can set the type of signal or the method of projection of the images input.

**[System settings] tab**  
You can set the operation of the projector.

**[Network settings] tab**  
These settings are for when using the projector from a PC via a network. For the network settings, refer to “Connecting to a Network” (P167).

**[Information] tab**  
You can check information about the signal types of the images projected and other information.

The screenshot shows the 'Input settings' tab selected. The menu items are: Aspect (Auto PC), Input signal select, Input signal settings, and Split screen. The 'Input signal settings' item is expanded to show: Auto, 1900 x 1200 123.456Hz, and Off. Labels 'Contents of menu' and 'Menu items' point to the menu list and the expanded item respectively.

### Input Signal Types for which a Menu Item is Displayed

Different menu items are displayed for different input signal types.

In the following explanation of each menu item, the input signal type for which the menu item is displayed is indicated as follows:

- Input signal for which the menu item is displayed
- Input signal for which the menu item is not displayed

- |                          |            |                          |           |                          |     |
|--------------------------|------------|--------------------------|-----------|--------------------------|-----|
| <input type="radio"/>    | HDMI       | <input type="checkbox"/> | Component | <input type="checkbox"/> | LAN |
| <input type="checkbox"/> | Digital PC | <input type="checkbox"/> | Analog PC | <input type="checkbox"/> | USB |

# Basic Menu Operations

- 1** Press the MENU button to display the menu window.

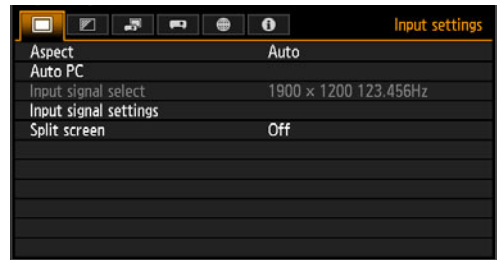
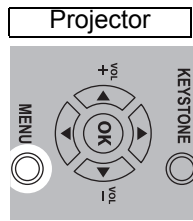
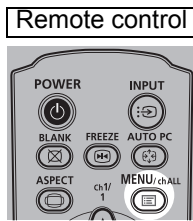

- 2** Press the [◀] / [▶] buttons to select a tab.

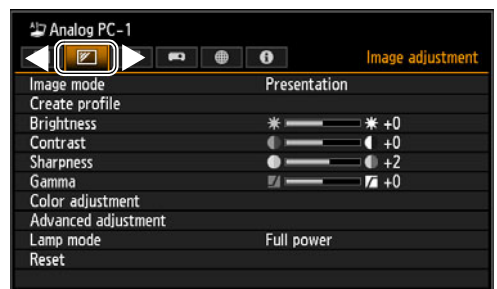
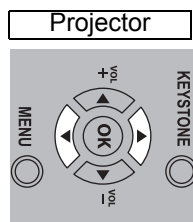
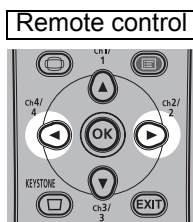

- If the tab position is not highlighted in orange, press the [▲] / [▼] buttons to move the current selection to the top.

- 3** Press the [▲] / [▼] buttons to select an item.

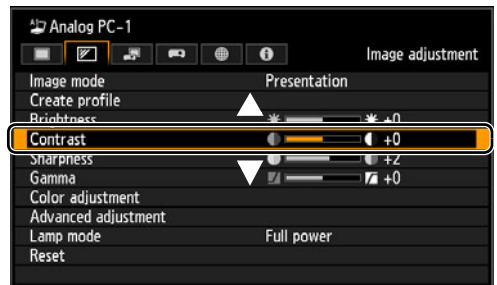
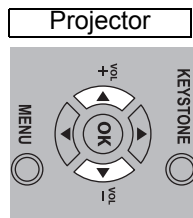
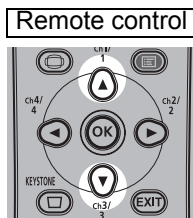

- 4** Select contents.

How to select the contents varies depending on the item.

## Selecting from a list Example: Aspect (P87)

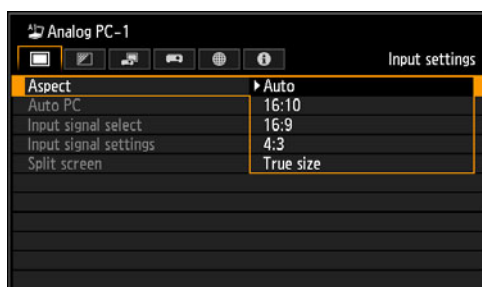

1. Select [Aspect].
2. Press the OK button or [▶] button to display a list of the contents.
3. Use the [▲] / [▼] buttons to select the desired contents.
4. When you have found the contents you desired, press the OK button or [▶].

## Adjusting with the [◀] / [▶] buttons Example: Contrast (P99)

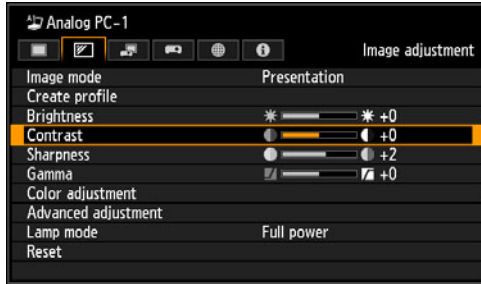

1. Select [Contrast].
2. Use the [◀] / [▶] buttons to adjust the setting.

## Selecting from a different screen (1) Example: Menu position (P154)

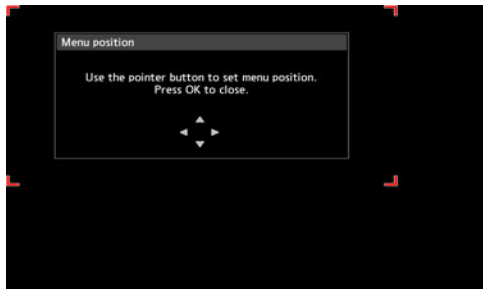

1. Select [Menu position].
2. Press the **OK** button to display a different screen.
3. Then follow the instruction on the screen.

## Selecting from a different screen (2) Example: Tracking (P89)

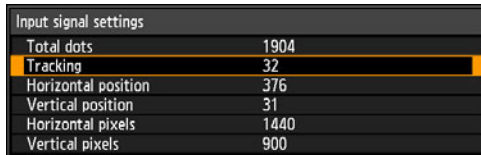

1. Select [Input signal settings].
2. Press the **OK** button to display a different screen.
3. Select [Tracking].
4. Use the [▲] / [▼] buttons to select the setting, then use the [◀] / [▶] buttons to select the value.
5. When you have completed the settings, press the **OK** button.

**5** Pressing the **MENU** button causes the menu screen to disappear. The menu screen will also disappear if the **EXIT** button is pressed.

# Setting Display Status (Input Settings)

## Selecting the Aspect

MENU > [Input settings] > [Aspect]

- HDMI       Component       LAN  
 Digital PC       Analog PC       USB

You can select a projection mode corresponding to the aspect ratio of the image. (P66)

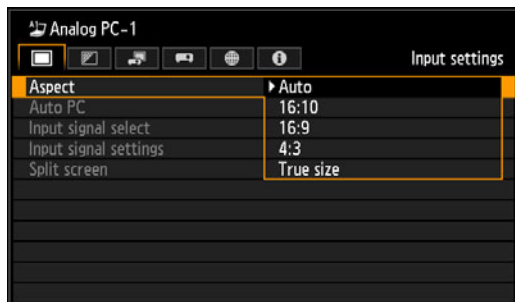

- For LAN and USB input, [Auto] is selected automatically.
- Different contents are displayed for different screen aspects or input signal types.
- The **ASPECT** button on the remote control can also be used to select the [Aspect] settings.

**Auto** An image is projected at the aspect ratio of the input signal. Select this mode for normal image projection.

**16:10** The image is projected using an input signal aspect ratio of 16:10.



- There may be some cases when this cannot be selected, depending on the input signal and/or resolution.

**16:9** The image is projected using an input signal aspect ratio of 16:9. Select this if an image of 16:9 aspect ratio cannot be correctly projected in [Auto] mode.

**4:3** The image is projected using an input signal aspect ratio of 4:3. Select this if an image of 4:3 aspect ratio cannot be correctly projected in [Auto] mode.

**Zoom** This cuts the upper/lower or left/right part of the screen according to the screen aspect and zooms in or out of the center of the image. Select this if a letter box is displayed (black lines at the top/bottom of the screen) when watching video.



- There may be some cases when this cannot be selected, depending on the input signal and/or resolution.

**True size** The image is projected with the original resolution of the input signal. Select this for clear projection of computer screens at up to WUXGA (WUX450/WUX400ST) or WXGA+ (WX520/WX450ST) resolution.



- There may be some cases when this cannot be selected, depending on the input signal and/or resolution.

Press the **OK** button to accept your setting and then press the **MENU** button or **EXIT** button.

## Setup Using Auto PC

**MENU** > [Input settings] > **[Auto PC]**

- HDMI            – Component    – LAN
- Digital PC    ○ Analog PC    – USB

**Automatically adjusts display position misalignment and screen flickering. The adjusted result is stored in the memory.**

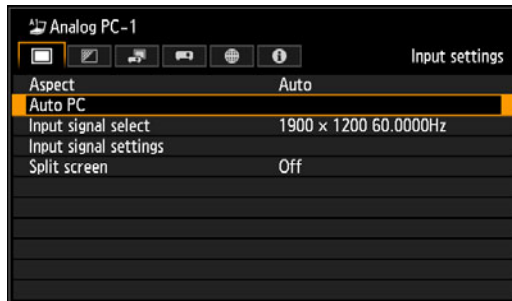

Press the **OK** button to accept your setting.



- If the Auto PC adjustment is insufficient, perform the following operations.
- Select the input signal that matches the resolution of the computer from [Input signal select]. (P88)
  - If adjustment is insufficient even when using the above operation, adjust [Total dots], [Tracking], [Horizontal/Vertical position] and [Horizontal/Vertical pixels] in [Input signal settings]. (P89 - P91)
  - For the signal types supported by the projector, see the table on [page 292](#).

## Selecting an Input Signal

**MENU** > [Input settings] > **[Input signal select]**

- HDMI            – Component    – LAN
- Digital PC    ○ Analog PC    – USB

**You can select a suitable resolution if the auto PC adjustment function (P57) cannot project the correct image from a computer.**

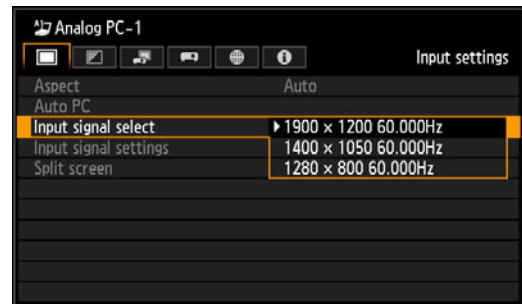

Press the **OK** button to accept your setting and then press the **MENU** button or **EXIT** button. Select an input signal corresponding to the resolution of the computer.

- For the signal types supported by the projector, see the table on [page 292](#).



## Adjusting the Input Signal



### (Total dots)

 > [Input settings] > [Input signal settings] > **[Total dots]**

— HDMI      — Component      — LAN  
— Digital PC      ○ Analog PC      — USB

You can adjust the total number of dots in the horizontal direction. Adjust it when stripes are displayed on the screen.

Input signal settings	
Total dots	1904
Tracking	32
Horizontal position	376
Vertical position	31
Horizontal pixels	1440
Vertical pixels	900

Use the [] / [] buttons to select a value.

When you have completed the adjustment, press the **OK** button to accept your setting and then press the **MENU** button or **EXIT** button.

- Perform this adjustment if the Auto PC function (P57) cannot adjust the projected image correctly.

## Adjusting the Input Signal

### (Tracking)



 > [Input settings] > [Input signal settings] > **[Tracking]**

— HDMI      — Component      — LAN  
— Digital PC      ○ Analog PC      — USB

You can fine-tune the timing for generating an image from the image signal.

Adjusts the tracking when the image distorts or flickers.

Input signal settings	
Total dots	1904
Tracking	32
Horizontal position	376
Vertical position	31
Horizontal pixels	1440
Vertical pixels	900

Use the [] / [] buttons to select a value.

When you have completed the adjustment, press the **OK** button to accept your setting and then press the **MENU** button or **EXIT** button.

- Perform this adjustment if the Auto PC function (P57) cannot adjust the projected image correctly.

## Adjusting the Input Signal

### (Horizontal position)

 > [Input settings] > [Input signal settings] > **[Horizontal position]**

— HDMI      — Component      — LAN  
— Digital PC      ○ Analog PC      — USB

You can adjust the horizontal position of the screen when the projected image is shifted in the horizontal direction.

Input signal settings	
Total dots	1904
Tracking	32
<b>Horizontal position</b>	<b>376</b>
Vertical position	31
Horizontal pixels	1440
Vertical pixels	900

Use the [**◀**] / [**▶**] buttons to select a value. As the value increases, the screen moves to the left.

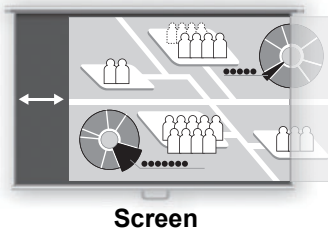

Screen

When you have completed the adjustment, press the **OK** button to accept your setting and then press the **MENU** button or **EXIT** button.

- Perform this adjustment if the Auto PC function (P57) cannot adjust the projected image correctly.

## Adjusting the Input Signal

### (Vertical Position)

 > [Input settings] > [Input signal settings] > **[Vertical position]**

— HDMI      — Component      — LAN  
— Digital PC      ○ Analog PC      — USB

You can adjust the vertical position of the screen when the projected image is shifted in the vertical direction.

Input signal settings	
Total dots	1904
Tracking	32
Horizontal position	376
<b>Vertical position</b>	<b>31</b>
Horizontal pixels	1440
Vertical pixels	900

Use the [**▲**] / [**▼**] buttons to select a value. As the value increases, the screen moves upward.

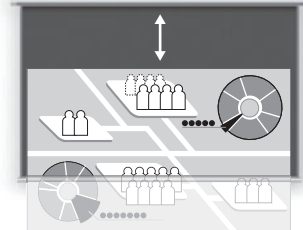

Screen

When you have completed the adjustment, press the **OK** button to accept your setting and then press the **MENU** button or **EXIT** button.

- Perform this adjustment if the Auto PC function (P57) cannot adjust the projected image correctly.

## Adjusting the Input Signal

### (Horizontal pixels)

**MENU** > [Input settings] > [Input signal settings] > **[Horizontal pixels]**

— HDMI      — Component      — LAN  
 — Digital PC      ○ Analog PC      — USB

You can adjust the number of the pixels in the horizontal direction if the length of the screen is too long or too short in the horizontal direction.

Input signal settings	
Total dots	1904
Tracking	32
Horizontal position	376
Vertical position	31
<b>Horizontal pixels</b>	<b>1440</b>
Vertical pixels	900

Use the [**◀**] / [**▶**] buttons to select a value.

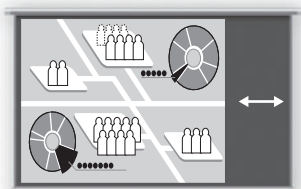

Screen

When you have completed the adjustment, press the **OK** button to accept your setting and then press the **MENU** button or **EXIT** button.

- Perform this adjustment if the Auto PC function (P57) cannot adjust the projected image correctly.

## Adjusting the Input Signal

### (Vertical pixels)

**MENU** > [Input settings] > [Input signal settings] > **[Vertical pixels]**

— HDMI      — Component      — LAN  
 — Digital PC      ○ Analog PC      — USB

You can adjust the number of the pixels in the vertical direction if the screen is too long or too short in the vertical direction.

Input signal settings	
Total dots	1904
Tracking	32
Horizontal position	376
Vertical position	31
Horizontal pixels	1440
<b>Vertical pixels</b>	<b>900</b>

Use the [**◀**] / [**▶**] buttons to select a value.

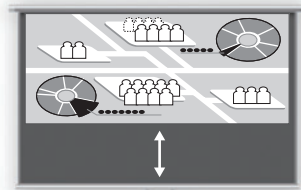

Screen

When you have completed the adjustment, press the **OK** button to accept your setting and then press the **MENU** button or **EXIT** button.

- Perform this adjustment if the Auto PC function (P57) cannot adjust the projected image correctly.

## Adjusting HDMI Input Level

**MENU** > [Input settings] > **[HDMI input level]**

- HDMI      – Component      – LAN
- Digital PC   – Analog PC      – USB

You can select this as required when you project visual software using an HDMI signal.

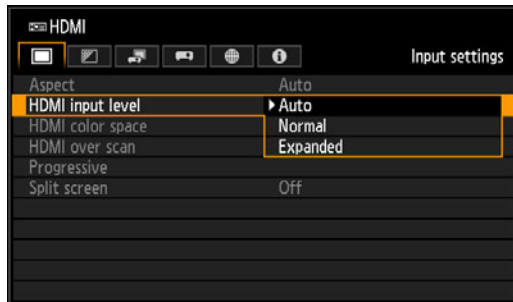

Press the **OK** button to accept your setting and then press the **MENU** button or **EXIT** button.

- [Auto] is the factory default.
- You can select this only when the type of signal sent from AV equipment is RGB.
- The signal level is selected automatically in [Auto] mode. (Some AV equipment may not support this.)
- If the HDMI output of your AV equipment allows switching between [Normal] and [Expanded], we recommend you to set [Expanded]. The contrast of images will be improved and dark scenes will be rendered more realistically. In this case, select [Auto] or [Expanded] for [HDMI input level]. For more detailed information, refer to the user's manual for the AV equipment connected to the projector.

## Setting the HDMI Color Format

**MENU** > [Input settings] > **[HDMI color space]**

- HDMI      – Component      – LAN
- Digital PC   – Analog PC      – USB

Select the color space for the HDMI signal.

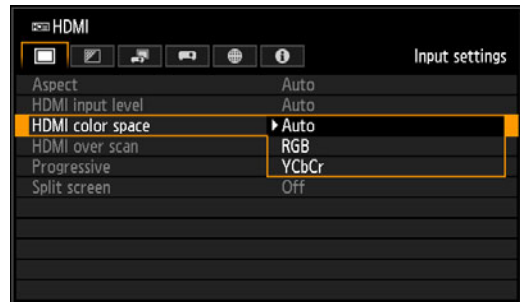

- |              |   |
|--------------|---|
| <b>Auto</b>  | Selects the optimal color format for the input HDMI signal.                   |
| <b>RGB</b>   | Forces the projector to handle the input signal as an RGB signal.             |
| <b>YCbCr</b> | Forces the projector to handle the input signal as a color difference signal. |

Press the **OK** button to accept your setting and then press the **MENU** button or **EXIT** button.

- [Auto] is the factory default.

## Specifying HDMI Overscan

**MENU** > [Input settings] > **[HDMI over scan]**

- HDMI      – Component      – LAN
- Digital PC   – Analog PC      – USB

When projecting images in videos via HDMI, select this setting to trim distorted image edges.

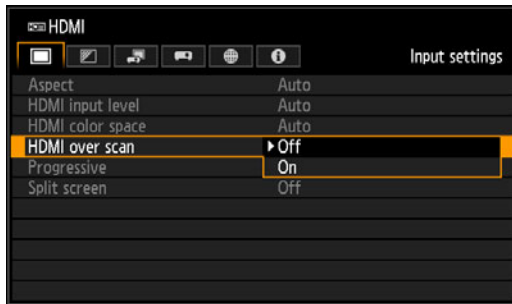

**Off** The entire input signal (100%) is projected.  
The images projected may be smaller than the full projection screen.

**On** Images are projected with distortion at the peripheral section of images trimmed off. (The central 95% of the image is projected.)  
Note that image edges are trimmed away, based on resolution. In such a case, select [Off].

Press the **OK** button to accept your setting and then press the **MENU** button or **EXIT** button.

- The factory defaults settings are [On] when [HDMI In] (P115) is set for [Auto] and [Off] when it is set for [Computer].

## Specifying Progressive Processing

**MENU** > [Input settings] > **[Progressive]**

- HDMI       Component      – LAN
- Digital PC   – Analog PC      – USB

Performs progressive processing optimized for still images in cinematic content or moving images in videos.

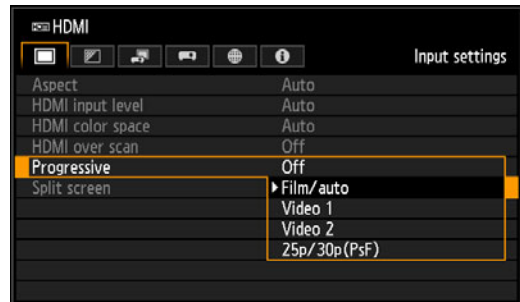

**Off** Does not perform progressive processing.

**Film/auto** Suitable for still images or typical moving images.  
Performs progressive processing for video or cinematic content.

**Video 1** Suitable for projecting video with high image quality and relatively slow movement.  
Performs progressive processing optimized for HD video.

**Video 2** Suitable for projecting video with faster movement.  
Performs progressive processing optimized for fast-moving video.

**25p/30p(PsF)** Performs progressive processing optimized for 1080PsF/25 or 1080PsF/30 video (25 or 30 fps, respectively).

Press the **OK** button to accept your setting and then press the **MENU** button or **EXIT** button.

## Setting Display Status (Input Settings)

- [Film/auto] is the factory default.
- Select [Off] when flickers and horizontal lines are noticeable in media that has a lot of fast-moving action.
- Not available during split-screen display.

## Specifying the Slideshow Interval

 > [Input settings] > [**Slideshow Interval**]

— HDMI      — Component      — LAN  
— Digital PC      — Analog PC      ○ USB

**You can project images on a USB flash drive automatically, one after another.**



Use the [**◀**] / [**▶**] buttons to select the interval for switching images (min.:sec.).

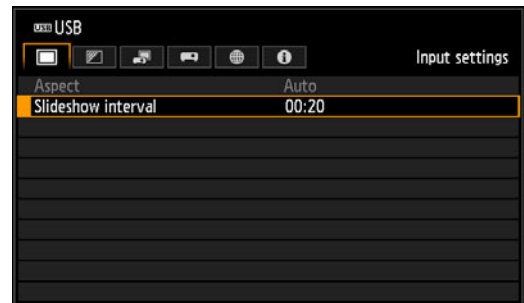

Press the **MENU** button or **EXIT** button.

- The factory default is [--:--], which does not switch images automatically.

## Specifying Split-Screen Display

MENU > [Input settings] > [Split screen]

- HDMI       Component      — LAN
- Digital PC     Analog PC      — USB

You can project two input images side by side. (P81)

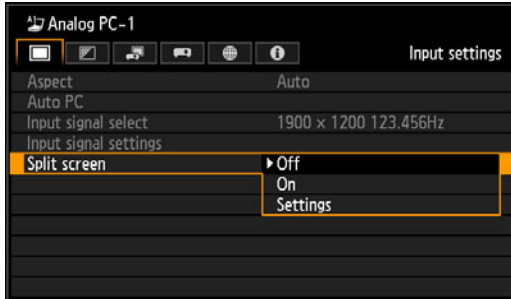

<b>Off</b>	Exit split-screen mode.		
<b>On</b>	Activates split-screen mode.		
<b>Settings</b>	<b>Split screen</b>	Off	Specify whether to use split-screen display.
		On	
	<b>Control rights</b>	Left screen	Select the image to control.
		Right screen	

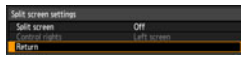

Press the **OK** button to accept your setting and then press the **MENU** button or **EXIT** button. The image under your control is labeled with a split-screen icon.

- [Off] is the factory default.
- The **SPLIT** button on the remote control can also be used to select the [Split screen] settings.
- If ▷ or ◁ is displayed in the center of the image area, switch control to the other side by pressing the [◀] / [▶] buttons on the remote control.
- When you switch to split-screen display, a dialog box indicates the left and right signals and input status.

# Adjusting Image Quality (Image Adjustment)

## Specifying Image Priority in Split-Screen Mode

**MENU** > [Image adjustment] > [Image priority]

- HDMI       Component      — LAN  
 Digital PC     Analog PC        — USB

Some image processing in split-screen mode is applied to both sides. Here, select which side to use as the primary side, which will be the basis for secondary-side processing.

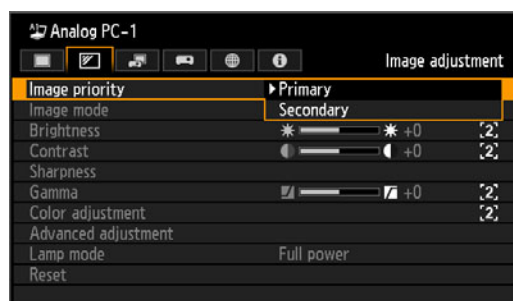

**Primary**      Selecting [Primary] will prevent you from reverting to [Secondary]. Switch control to the other side, and then select [Primary] again.

**Secondary**      Sets the current side (with control rights) as the secondary side.

Press the **OK** button to accept your setting and then press the **MENU** button or **EXIT** button.

Some image adjustment settings in split-screen mode apply to the left and right sides independently. For others, the setting for the [Primary] side is also applied to the [Secondary] side.

Can be independently configured Brightness (P99), Contrast (P99), Gamma (P100), Color adjustment (P101), Fine-Tune Gamma (P105)

**[Primary] setting also applies to [Secondary]**

Image Mode (P97), Advanced adjustment (except Fine-Tune Gamma) (P102-P106), Lamp mode (P107)



## Specifying the Image Mode

MENU > [Image adjustment] > **[Image mode]**

- HDMI     Component     LAN  
 Digital PC     Analog PC     USB

You can select an image mode (P71) suitable for the projected image.

You can also select it with the **IMAGE** button on the remote control. (P72)

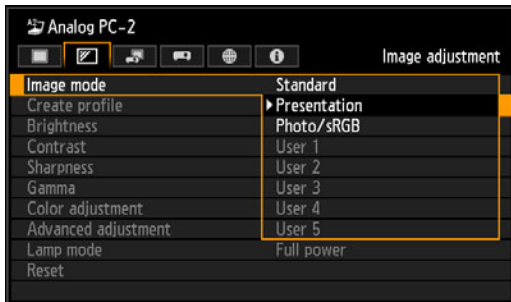

<b>Standard</b>	Suitable for projecting a computer screen or watching video in a brightish room. This image mode emphasizes white tones.
<b>Presentation</b>	Suitable for viewing text-based images in a brightish room.
<b>Dynamic</b>	Suitable for watching video in a brightish room.
<b>Video</b>	Suitable for watching video taken with a video camera in a moderately dark room.
<b>Photo/sRGB</b>	Suitable for projecting images taken with a digital camera that supports sRGB in a moderately dark room. Compatible with the sRGB color space.
<b>User 1–5</b>	Up to 5 user-selected combinations of image quality settings can be stored in the memory. (P98) Stored settings can be selected as an image mode.

Press the **OK** button to accept your setting and then press the **MENU** button or **EXIT** button.

- [Standard] is the factory default for Analog PC-1 or 2, Digital PC, or HDMI (when [HDMI In] is [Computer]), LAN or USB, and [Photo/sRGB] is the default for HDMI (when [HDMI In] is [Auto]) or Component.
- You can adjust the image quality by adjusting the following items in each image mode: [Brightness], [Contrast], [Sharpness], [Gamma], [Color adjustment], [Advanced adjustment] and [Lamp mode]
- The adjustment you have made is stored as each combination of input signals and an image mode.
- When a user memory that was saved in [Create profile] is selected, [Baseline image mode] appears in the menu. This indicates the image mode that was the base when the user memory was saved.

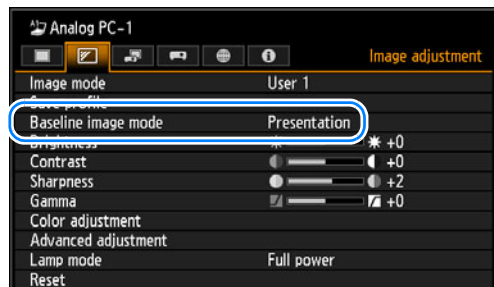
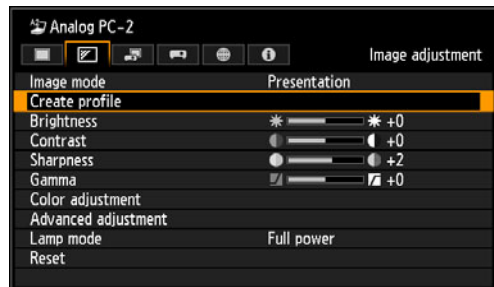

# Creating/Saving a User Profile

**MENU** > [Image adjustment] > **[Create profile]**

- |                                  |                                 |       |
|----------------------------------|---------------------------------|-------|
| <input type="radio"/> HDMI       | <input type="radio"/> Component | — LAN |
| <input type="radio"/> Digital PC | <input type="radio"/> Analog PC | — USB |

**Up to 5 combinations of image quality settings can be stored. The stored image quality can be selected as an image mode.**

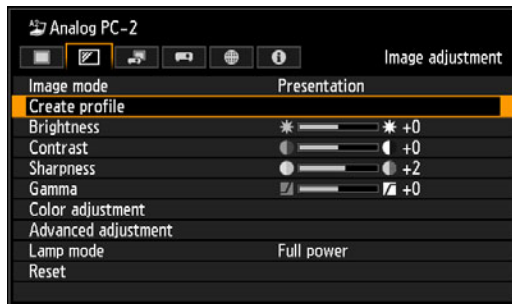

Use the [**▲**] / [**▼**] buttons and select the save destination. (Saved memories are indicated by checkmarks.)

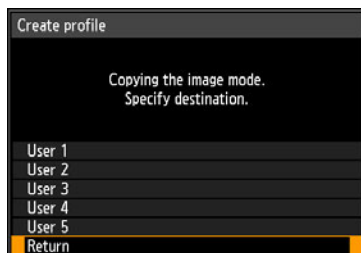

When the desired save destination is selected, press the **OK** button to accept your setting and then press [Return].

- The saved settings consist of the brightness, contrast, sharpness, gamma, color adjustment, advanced adjustment, and lamp mode.

- The number of displayed user memories is 5, however it is possible to save different settings for when the connected equipment is a computer (ANALOG PC, DIGITAL PC or HDMI (when [HDMI In] (P115) is [Computer]) and when AV equipment is connected (COMPONENT, HDMI (when [HDMI In] (P115) is [Auto])). As a result, it is possible to save up to 10 settings.
- The image mode name which was the basis for the settings change is also saved in the user memory. When a user memory is selected as the image mode, the image mode that was the base for that user memory is displayed in the menu as [Baseline image mode].

## Adjusting Brightness

**MENU** > [Image adjustment] > **[Brightness]**

- HDMI     Component     LAN  
 Digital PC     Analog PC     USB

You can adjust the brightness of images.

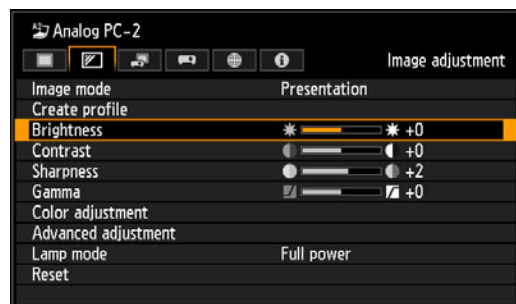

**[▶]** Increases the brightness of an image.

**[◀]** Decreases the brightness of an image.

When you have completed the adjustment, press the **MENU** or **EXIT** button.

- The adjustments you have made are stored as adjusted values for the input signals and image mode of the current projection.

## Adjusting Contrast

**MENU** > [Image adjustment] > **[Contrast]**

- HDMI     Component     LAN  
 Digital PC     Analog PC     USB

You can adjust the contrast of images.

Adjust the difference between the light and dark parts of the image to produce an image with emphasized contrast or an image that is soft.

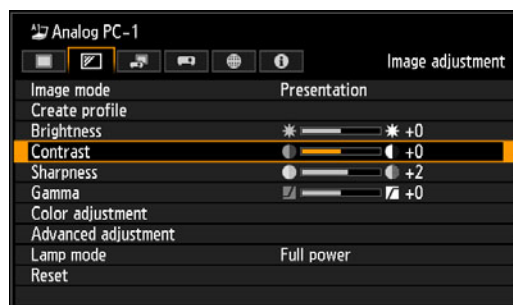

**[▶]** Increases the contrast of an image. This emphasizes the darker and brighter parts of the image on the projected image.

**[◀]** Decreases the contrast of an image. The image becomes less vivid.

When you have completed the adjustment, press the **MENU** or **EXIT** button.

- The adjustments you have made are stored as adjusted values for the input signals and image mode of the current projection.

## Adjusting Sharpness

**MENU** > [Image adjustment] > **[Sharpness]**

- HDMI
- Component
- LAN
- Digital PC
- Analog PC
- USB

You can adjust the sharpness of images.

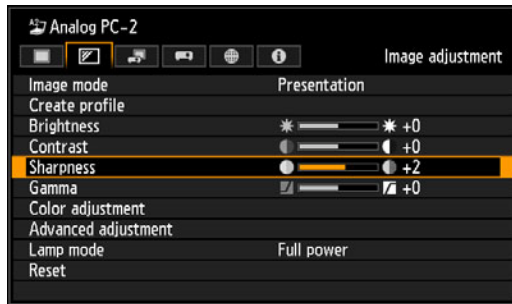

[▶] Increases the sharpness of an image.

[◀] Decreases the sharpness of an image.

When you have completed the adjustment, press the **MENU** or **EXIT** button.

- The adjustments you have made are stored as adjusted values for the input signals and image mode of the current projection.

## Correcting Gamma

**MENU** > [Image adjustment] > **[Gamma]**

- HDMI
- Component
- LAN
- Digital PC
- Analog PC
- USB

You can correct portions of an image that are difficult to see because they are too dark or bright.

Gamma can be corrected using the **GAMMA** button on the remote control.

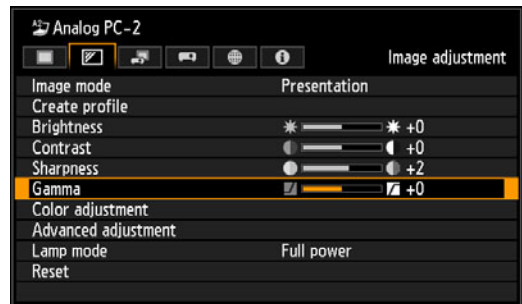

[▶] Brightens the dark portion.

[◀] Darkens the bright portion.

When you have completed the adjustment, press the **MENU** or **EXIT** button.

- The adjustments you have made are stored as adjusted values for the input signals and image mode of the current projection.
- More detailed adjustment is possible by using the detailed gamma correction (P105).

## Adjusting Colors

 > [Image adjustment] > [Color adjustment]

- HDMI     Component     LAN  
 Digital PC     Analog PC     USB

You can adjust the color depth and hue of images for each primary color, red, green and blue. The color temperature can also be adjusted.



<b>Color level</b>	Adjusts the intensity of colors. [▶] Increases the intensity of color. [◀] Decreases the intensity of color.
<b>Color balance</b>	Adjusts the color balance of a purplish or greenish image. [▶] Corrects a purplish image. [◀] Corrects a greenish image.
<b>Color temperature</b>	Adjusts the color temperature of the image. [▶] Changes to a bluish color (cold color). [◀] Changes to a reddish color (warm color).
<b>R / G / B Gain</b>	Adjusts the intensity of each color. [▶] Increases the color intensity. [◀] Decreases the color intensity.
<b>R / G / B Offset</b>	Adjusts the color reproducibility of dark portions of each color. [▶] Increases the color reproducibility. [◀] Decreases the color reproducibility.

When you have completed the adjustment, press the **MENU** or **EXIT** button.

- The adjustments you have made are stored as adjusted values for the input signals and image mode of the current projection.

## Adjusting to the Ambient Light (Ambient Light)

 > [Image adjustment] > [Advanced adjustment] > **[Ambient light]**

- HDMI       Component    — LAN
- Digital PC    Analog PC    — USB

You can correct and more effectively project an image according to the ambient light on the screen. The [Ambient light] setting is available in Photo/sRGB image mode (P97).

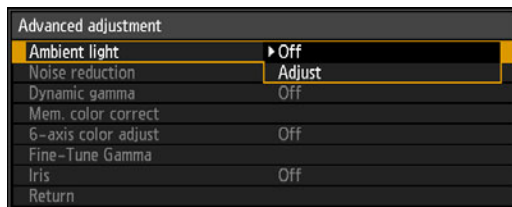

**Off** Projects an image with no correction.

**Adjust** You can specify the type and level (brightness) of the ambient light.

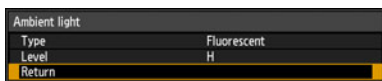

**Type Tungsten**  
Select this if the ambient light source is a light bulb or bulb color fluorescent.

**Fluorescent**  
Select this if the ambient light source is a day white fluorescent.



**Level L** Select this if the ambient light is normal.

**H** Select this if the ambient light is high (bright).



### Examples of Ambient Light Level Settings

Level	Example Location
L	Projection room, sports bar, etc.
H	Conference room, lecture room

Press the **OK** button to accept your setting and then press the **MENU** button or **EXIT** button.

- [Off] is the factory default.

## Reducing Image Noise

### (Noise reduction)

 > [Image adjustment] > [Advanced adjustment] > **[Noise reduction]**

HDMI     Component     LAN  
 Digital PC     Analog PC     USB

You can reduce image noise.

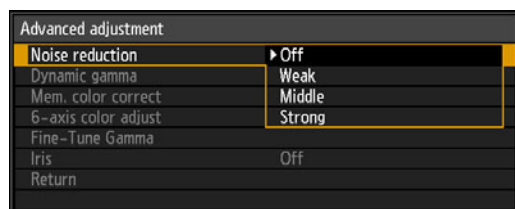

<b>Off</b>	Disables noise reduction.
<b>Weak</b>	Specifies the intensity of the noise reduction in three steps.
<b>Middle</b>	
<b>Strong</b>	

Press the **OK** button to accept your setting and then press the **MENU** button or **EXIT** button.

- The factory default for HDMI (when [HDMI In] (P115) is set to [Auto]) is [Off] and when Component is used, it is set to [Weak].
- Image resolution may seem lower when noise reduction is applied.
- Select [Weak] for fast-moving images. Select [Strong] for slow-moving images.
- The adjustment you have made is stored as adjusted values for the input signals and image mode of the current projection.
- When [HDMI In] (P115) is [Computer], this setting is not displayed.

## Dynamic Gamma Adjustment

 > [Image adjustment] > [Advanced adjustment] > **[Dynamic gamma]**

HDMI     Component     LAN  
 Digital PC     Analog PC     USB

You can adjust the gradation representation of light and dark portions of an image automatically.

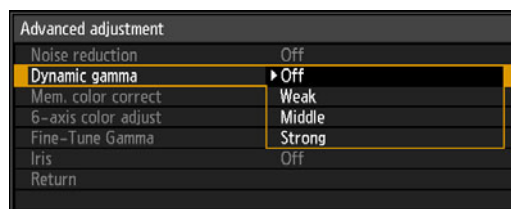

<b>Off</b>	Dynamic gamma is disabled.
<b>Weak</b>	Specifies the intensity of the dynamic gamma in three steps.
<b>Middle</b>	
<b>Strong</b>	

Press the **OK** button to accept your setting and then press the **MENU** button or **EXIT** button.

- The factory default settings are [Off] when the connected equipment is a Computer (ANALOG PC, DIGITAL PC, HDMI (when [HDMI In] (P115) is [Computer])) and [Weak] when the connected equipment is AV equipment (COMPONENT, HDMI (when [HDMI In] (P115) is [Auto])).
- The adjustments you have made are stored as adjusted values for the input signals and image mode of the current projection.

## Correcting Memory Color

**MENU** > [Image adjustment] > [Advanced adjustment] > **[Mem. color correct]**

- HDMI     Component     LAN  
 Digital PC     Analog PC     USB

Enhances skin tones, blue skies, and greens, so that these colors are more consistent with people's remembered impressions.

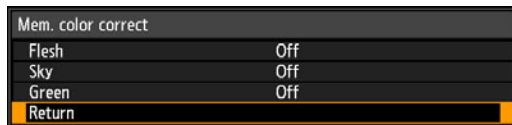

**Flesh** Specifies the intensity of enhancement: [Off], [Weak], [Middle], or [Strong]. Set to [Off] to disable enhancement.

Press the **OK** button to accept your setting and then press the **MENU** button or **EXIT** button.

- The factory default settings are as follows.
  - For HDMI (when [HDMI In] (P115) is set to [Computer]), Digital PC, Analog PC, USB, or LAN, the default setting is [Off].
  - For HDMI (when [HDMI In] (P115) is set to [Auto]) and Component, the default setting is [Weak], regardless of the image mode.
- The adjustments you have made are stored as adjusted values for the input signals and image mode of the current projection.

## Fine-Tuning Colors (6-axis Color Adjustment)

**MENU** > [Image adjustment] > [Advanced adjustment] > **[6-axis color adjust]**

- HDMI     Component     LAN  
 Digital PC     Analog PC     USB

You can make fine adjustments to the image colors with RGB (red, green, blue) and CMY (cyan, magenta, yellow).

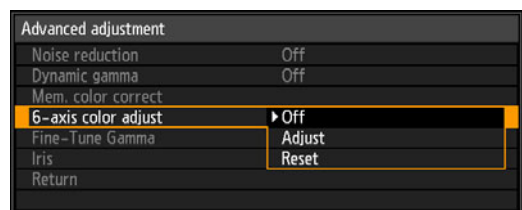

**Off** Disables 6-axis color adjustment. If you select [Adjust], the previous setting of 6-axis color adjustment becomes active again.

**Adjust** Enables 6-axis color adjustment.

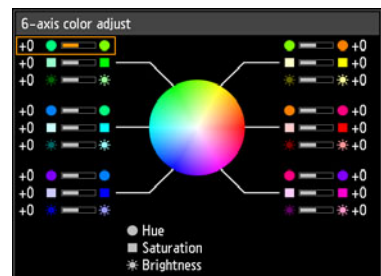

Use the [**▲**] / [**▼**] buttons to select [**○**Hue], [**□**Saturation], or [**\*** Brightness], then adjust them with the [**◀**] / [**▶**] buttons. When color adjustments are completed, press the **OK** button.

**Reset** Returns all adjustment values to zero.

When you have completed the adjustment, press the **OK** button to accept your setting and then press the **MENU** button or **EXIT** button.



- [Off] is the factory default.
- The adjustments you have made are stored as adjusted values for the input signals and image mode of the current projection.
- Adjustment is not shown on the projected menu screen itself.

## Fine-Tuning Gamma

 > [Image adjustment] > [Advanced adjustment] > **[Fine-Tune Gamma]**

- |                                  |                                 |                           |
|----------------------------------|---------------------------------|---------------------------|
| <input type="radio"/> HDMI       | <input type="radio"/> Component | <input type="radio"/> LAN |
| <input type="radio"/> Digital PC | <input type="radio"/> Analog PC | <input type="radio"/> USB |

**The four gamma curves (white, red, green, blue) can be adjusted. Red, green, and blue can be adjusted separately. Adjustments to white are also applied to the three other colors. Note that adjusting any color will overwrite previous adjustments.**

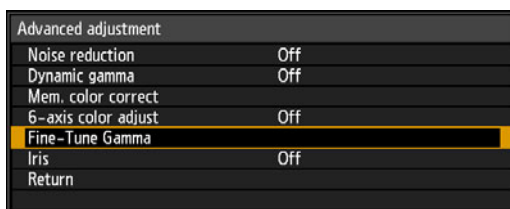

Select [Fine-Tune Gamma] then press the **OK** button. The following [Fine-Tune Gamma] screen for confirmation appears.

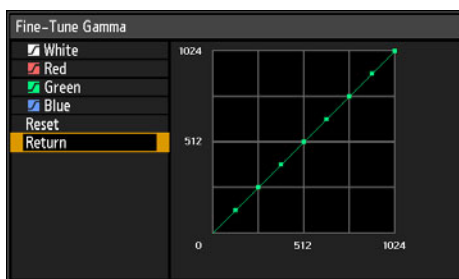

Use the [**▲**] / [**▼**] buttons to select the color, then press the **OK** button. Next, use the [**◀**] / [**▶**] buttons to select a point on the gamma curve, and use the [**▲**] / [**▼**] buttons to adjust the position of the point. When you have completed the adjustment, press the **OK** button to accept your setting and then press the **MENU** button or **EXIT** button.

- The adjustments you have made are stored as adjusted values for the input signals and image mode of the current projection.
- For details of gamma correction, refer to [page 100](#).
- RGB offset (relative to 0) can be adjusted by using the R/G/B Offset function (“Adjusting Colors” (P101)).
- Adjustment is not applied to the projected menu itself. Perform adjustment using input signals or a built-in test pattern.

## Controlling Contrast (Iris)

 > [Image adjustment] > [Advanced adjustment] > **[Iris]**

- HDMI       Component       LAN  
 Digital PC       Analog PC       USB

**You can control image contrast by opening or closing the iris.**

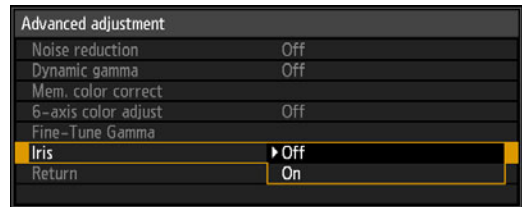

---

**Off**      Keeps the iris fully open.  
Emphasizes brightness over contrast.

---

**On**      Keeps the iris halfway open.  
Emphasizes contrast over brightness.

---

Press the **OK** button to accept your setting and then press the **MENU** button or **EXIT** button.

- [Off] is the factory default.
- The adjustment you have made is stored as adjusted values for the input signals and image mode of the current projection.

## Specifying the Lamp Mode

**MENU** > [Image adjustment] > **[Lamp mode]**

- HDMI     Component     LAN  
 Digital PC     Analog PC     USB

Reducing the lamp brightness reduces power consumption and cooling fan noise.

You can access the **[Lamp mode]** menu by pressing the **ECO** button on the remote control.

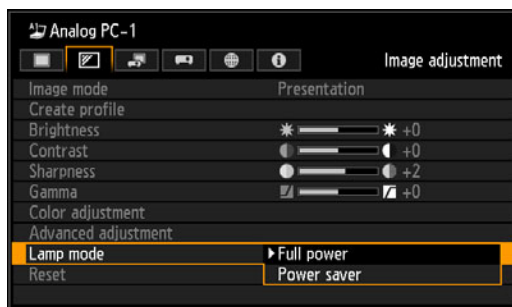

<b>Full power</b>	Projects images at full brightness.
<b>Power saver</b>	Reduces lamp brightness to save energy.

Press the **OK** button to accept your setting and then press the **MENU** button or **EXIT** button.

- The factory default is [Full power].
- The adjustment you have made is stored as adjusted values for the input signals and image mode of the current projection.

## Resetting Image Adjustment Settings

**MENU** > [Image adjustment] > **[Reset]**

- HDMI     Component     LAN  
 Digital PC     Analog PC     USB

You can reset the current image adjustment settings to the default settings. If reset is performed when user setting 1–5 is selected for [Image mode], the settings are returned to the settings that were saved in [User 1–5].

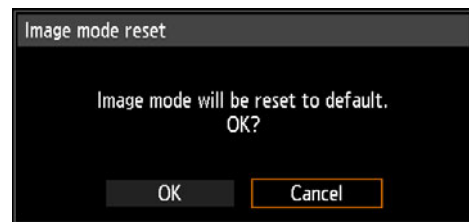

<b>OK</b>	Resets the image adjustment settings.
<b>Cancel</b>	Cancels resetting of the image adjustment settings.

- Only the setting for the combination of input signal and image mode for the current projection is reset.

## Registering User Logos

 > [System settings] > [User screen settings] > **[Logo capture]**

- HDMI       Component       LAN  
 Digital PC       Analog PC       USB

Registers the current image as a user logo. Registered user logos can be shown when no signal is received, when the **BLANK** button is pressed, or as the startup image.

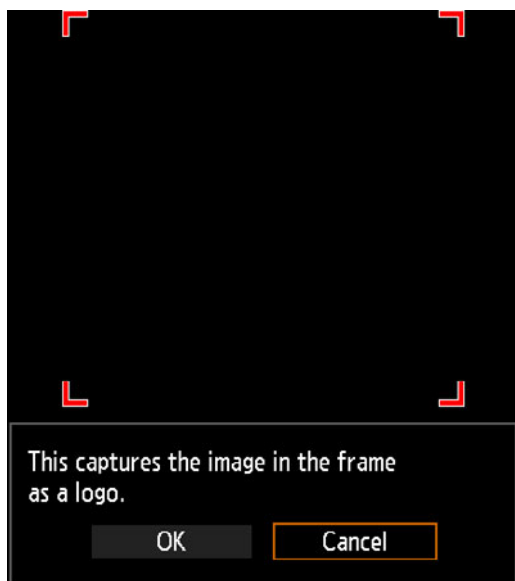
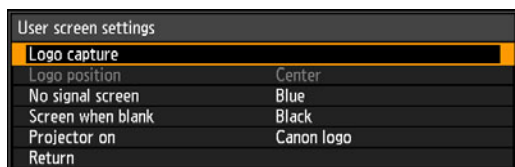

**OK** Display the image for logo registration. Align the image with the red boundary lines indicating the portion that will be stored, and then press the **OK** button. The portion of the image within the boundary lines is now registered.

**Cancel** Cancels logo registration.

Press the **OK** button to accept your setting and then press the **MENU** button or **EXIT** button.

## Positioning User Logos

 > [System settings] > [User screen settings] > **[Logo position]**

- HDMI       Component       LAN  
 Digital PC       Analog PC       USB

Specify the position of registered user logos as follows.

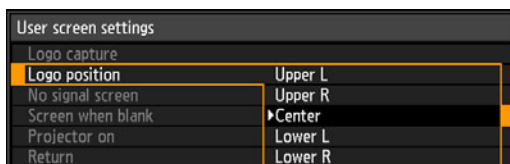

**Upper L**

**Upper R**

**Center** Indicates the display position for user logos.

**Lower L**

**Lower R**

- The factory default is [Center].
- You can specify the position after a logo has been registered.

## No Signal Screen

 > [System settings] > [User screen settings] > **[No signal screen]**

- HDMI     Component     LAN  
 Digital PC     Analog PC     USB

As the image projected when there is no input signal, you can choose a black, blue, or registered user screen.

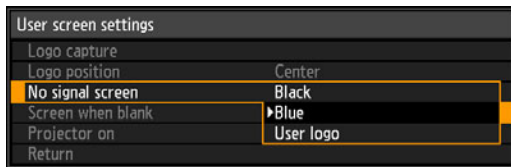

<b>Black</b>	The screen is all black.
<b>Blue</b>	The screen is all blue.
<b>User logo</b>	The user logo is projected.

Press the **OK** button to accept your setting and then press the **MENU** button or **EXIT** button.

- [Blue] is the factory default.

## Screen When Blank

 > [System settings] > [User screen settings] > **[Screen when blank]**

- HDMI     Component     LAN  
 Digital PC     Analog PC     USB

You can project a black, blue, or registered user screen to blank out projection temporarily by pressing the **BLANK** button on the remote control.

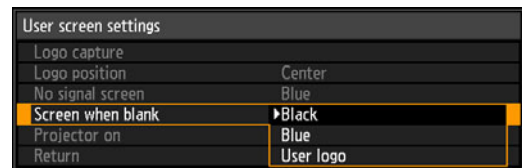

<b>Black</b>	The screen is all black.
<b>Blue</b>	The screen is all blue.
<b>User logo</b>	The user logo is projected.

Press the **OK** button to accept your setting and then press the **MENU** button or **EXIT** button.

- [Black] is the factory default.

## Selecting a Logo at Startup

**MENU** > [System settings] > [User screen settings] > **[Projector on]**

- HDMI     Component     LAN  
 Digital PC     Analog PC     USB

You can display a specified logo on the screen from the moment the projector is turned on to the moment it is ready for projection.

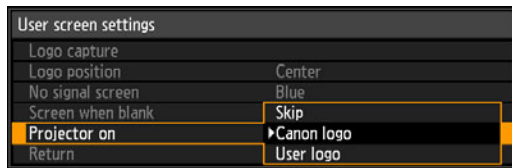

<b>Skip</b>	Projects an input signal immediately after turning on the projector.
<b>Canon logo</b>	Displays the Canon logo that was registered in advance at the factory.
<b>User logo</b>	The user logo is projected.

Press the **OK** button to accept your setting and then press the **MENU** button or **EXIT** button.

- [Canon logo] is the factory default.
- Only images with an aspect of 16:10 can be registered as user logos.

## Specifying Auto Power-Off

**MENU** > [System settings] > **[Auto power-off]**

- HDMI     Component     LAN  
 Digital PC     Analog PC     USB

You can turn off the lamp or projector automatically in order to save power when the projector is not in use.

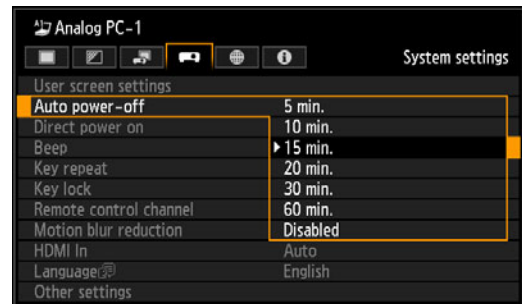

<b>5 min.–60 min.</b>	If the selected time elapses without any input signal, the projector displays the countdown of the time until the projector will be turned off.
<b>Disabled</b>	Disable auto power-off.



Press the **OK** button to accept your setting and then press the **MENU** button or **EXIT** button.

- [15 min.] is the factory default.
- You cannot enable the [Direct power on] function (see the next item), if you select [Disabled].

## Specifying Direct Power-On

**MENU** > [System settings] > [Direct power on]

- HDMI     Component     LAN  
 Digital PC     Analog PC     USB

You can turn on the projector by connecting the power cable without pressing the **POWER** button.

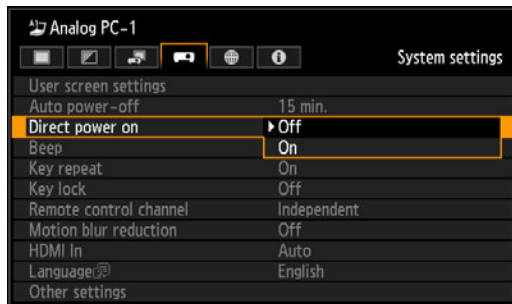

- |            |   |
|------------|---|
| <b>Off</b> | You need to press the <b>POWER</b> button to turn on the projector. |
| <b>On</b>  | You can turn on the projector by connecting the power cable only.   |

Press the **OK** button to accept your setting and then press the **MENU** button or **EXIT** button.

- [Off] is the factory default.



- Before enabling direct power on, be sure to set [Auto power-off] to an option other than [Disabled]. Selecting [Disabled] will prevent you from using auto power-off.
- After turning off the projector, wait at least 5 minutes before turning it on again. It may shorten the lamp life if you turn on the projector immediately after turning it off.

## Specifying Silence or Operating Tones

**MENU** > [System settings] > [Beep]

- HDMI     Component     LAN  
 Digital PC     Analog PC     USB

You can select whether a beep sounds or not when you operate the projector.



- |            |                    |
|------------|--------------------|
| <b>Off</b> | Disables the beep. |
| <b>On</b>  | Enables the beep.  |

Press the **OK** button to accept your setting and then press the **MENU** button or **EXIT** button.

- The factory default is [On].
- The beep will not sound if you mute the projector sound with the **MUTE** button on the remote control.

## Specifying Key Repeat Operation

**MENU** > [System settings] > **[Key repeat]**

- HDMI     Component     LAN  
 Digital PC     Analog PC     USB

By pressing and holding the button on the projector or the remote control you can operate Key repeat in the same way as when the button is pressed repeatedly.

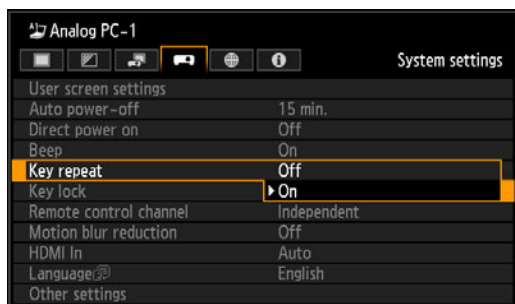

**Off** Key repeat is not enabled.

**On** Key repeat is enabled.

Press the **OK** button to accept your setting and then press the **MENU** button or **EXIT** button.

- The factory default is [On].

## Locking Projector or Remote Buttons

**MENU** > [System settings] > **[Key lock]**

- HDMI     Component     LAN  
 Digital PC     Analog PC     USB

You can lock the projector to prevent its operation from either the main unit or remote control.

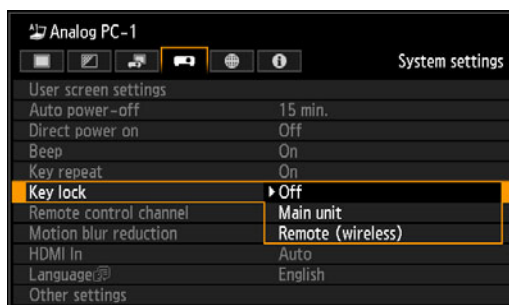

**Off** Disables the key lock.

**Main unit** Operation is not possible using the main unit. Use the remote control.

**Remote (wireless)** Disables infrared remote control operations (P36). Use buttons on the main unit. Alternatively, use the optional remote control (RS-RC05), connected to the projector via a cable.

Press the **OK** button to accept your setting and then press the **MENU** button or **EXIT** button.

- [Off] is the factory default.

The key lock function becomes effective from the moment the **OK** button is pressed after selecting [Main unit] or [Remote (wireless)]. Control via the item selected will then be disabled.



## To Unlock Key Lock Function

Turn off the projector and unplug the power plug. Hold down the **OK** button on the main unit and plug in the power cord, as you continue to hold down the **OK** button. In a moment, a beep will sound, and the controls will be unlocked.

## Assigning a Channel for Remote Control

**MENU** > [System settings] > [Remote control channel]

- HDMI       Component       LAN  
 Digital PC       Analog PC       USB

When using multiple projectors at the same time (maximum 4), you can assign a different channel to each remote control so that each operates independently.

## Selecting the Projector Channel



**Ch1** Select the remote control channel to use with this projector.  
**Ch2**  
**Ch3**  
**Ch4**

**Independent** Remote controls set to any channel can be used.

Press the **OK** button to accept your setting and then press the **MENU** button or **EXIT** button.

- The factory default is [Independent] for both projector and remote control.
- After changing the channel on the menu, be sure to change the channel of the remote control too.
- If a cable is connected, it is not necessary to perform remote control channel setting.

## Selecting a Channel on the Remote control

You can change the channel on the remote control as follows.

<b>Ch1</b>	Press and hold the <b>OK</b> button and [ <b>▲</b> ] button at the same time for 3 seconds.
<b>Ch2</b>	Press and hold the <b>OK</b> button and [ <b>▶</b> ] button at the same time for 3 seconds.
<b>Ch3</b>	Press and hold the <b>OK</b> button and [ <b>▼</b> ] button at the same time for 3 seconds.
<b>Ch4</b>	Press and hold the <b>OK</b> button and [ <b>◀</b> ] button at the same time for 3 seconds.
<b>Independent</b>	Press and hold the <b>OK</b> button and  button at the same time for 3 seconds.

## Reducing Motion Blur

 > [System settings] > [**Motion blur reduction**]

- HDMI       Component      – LAN  
 Digital PC       Analog PC      – USB

**Motion blur is blurring that occurs during video playback. Motion blur reduction can make this blurring less noticeable. This function is available in [Presentation] or [Dynamic] image modes (P97).**

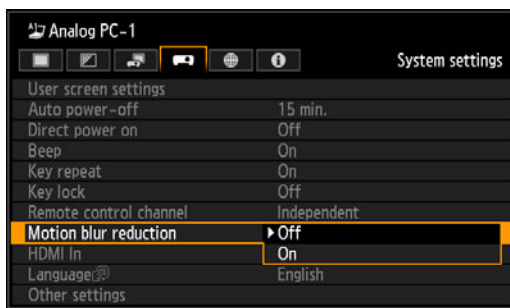

**Off** Motion blur reduction is not performed.

**On** Motion blur reduction is performed.

Press the **OK** button to accept your setting and then press the **MENU** button or **EXIT** button.

- [Off] is the factory default.
- If motion blur reduction generates distracting image noise, select [Off].
- Effects of motion blur reduction cannot be checked during menu display.
- Especially effective for motion of computer graphics and similar high-resolution images.

## Specifying HDMI Input

**MENU** > [System settings] > [HDMI In]

- HDMI     Component     LAN  
 Digital PC     Analog PC     USB

Set the type of equipment which is connected to the HDMI port.

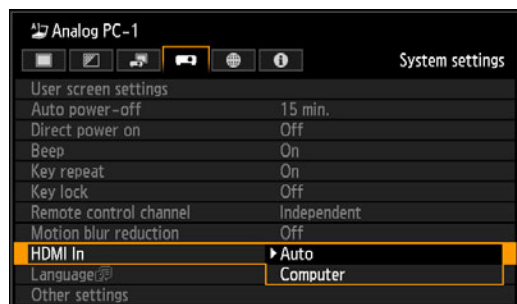

**Auto** Select when AV equipment will be connected. Image processing, menu displays, and other elements are adjusted for video equipment.

**Computer** Select when a computer will be connected. Image processing, menu displays, and other elements are adjusted for a computer.

Press the **OK** button to accept your setting and then press the **MENU** button or **EXIT** button.

- [Auto] is the factory default.

## Selecting a Display Language

**MENU** > [System settings] > [Language]

- HDMI     Component     LAN  
 Digital PC     Analog PC     USB

You can select the language in which the menus are displayed.

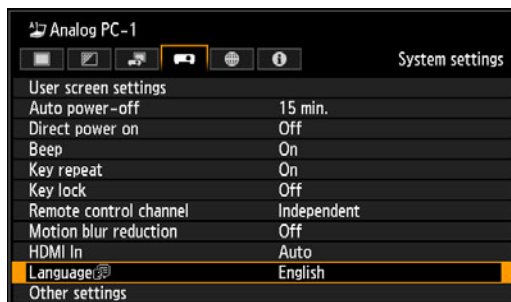

Use the [**▲**] / [**▼**] / [**▶**] / [**◀**] buttons to select the menu language, then press the **OK** button.

English	English
German	Deutsch
French	Français
Italian	Italiano
Spanish	Español
Portuguese	Português
Swedish	Svenska
Russian	Русский
Dutch	Nederlands
Finnish	Suomi
Norwegian	Norsk
Turkish	Türkçe
Polish	Polski
Hungarian	Magyar
Czech	Čeština
Danish	Dansk
Arabic	إنجليزي
Chinese (Simplified)	中文简体
Chinese (Traditional)	中文繁體
Korean	한국어
Japanese	日本語

When the setting is completed, press the **OK** button to accept your setting and then press the **MENU** button or **EXIT** button.

## Requiring a Password for Operation

 > [System settings] > [Other settings] > [Password settings]

HDMI       Component       LAN  
 Digital PC       Analog PC       USB

**Disables the projector unless the correct password is entered.**

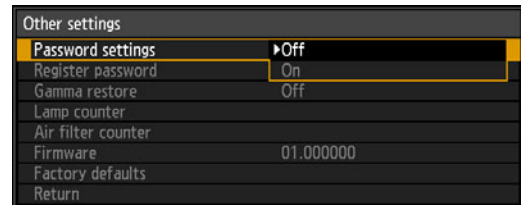

---

**Off**    The projector can be used even if no password is entered.

---

**On**    The projector cannot be used unless you enter your password.

---

Press the **OK** button to accept your setting and then press the **MENU** button or **EXIT** button.

- [Off] is the factory default.
- You cannot set [On] unless you have completed [Register password].

Once you set a password, the password entry screen appears at power-on.

Enter a 4 digit password.

Enter the password using the [▲] / [▶] / [▼] / [◀] buttons.

If the password is valid, the projection starts. If you enter a wrong password three times, the power will be turned off.

- The power is also turned off if no password is input for 3 minutes.

### To Cancel the Password

Turn off the projector and unplug the power plug.

Hold down the **MENU** button on the side control and connect the power plug. Make sure to keep holding down the **MENU** button until a beep sounds. When the beep sounds, the password is canceled. (The entered password is also reset.)

To forcibly cancel the password from the remote control, in standby state press the **MENU** button 3 times, then press the **POWER** button.

## Setting a Password

 > [System settings] > [Other settings] > [Register password]

- HDMI       Component       LAN  
 Digital PC       Analog PC       USB

**You can register a password for starting projection.**

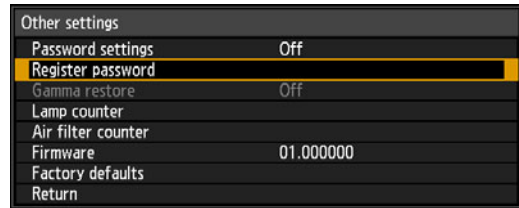

Press the **OK** button after selecting [Register password], and the following screen for registering a password appears.



Enter a 4 digit password.

Enter the password using the [▲] / [▶] / [▼] / [◀] buttons.

The 4-digit password is entered from the left to right digits. When the final digit is entered, the password is automatically registered.

Press the **MENU** button to abort the registration.

## Restoring Original Gamma Settings

MENU > [System settings] > [Other settings] > [Gamma restore]

- HDMI     Component     LAN  
 Digital PC     Analog PC     USB

This function is used when changing and turning of the tone characteristics and achromatic color is noticed over a long period of time. Gamma restore can only be used when the lamp has been on for approximately 30 minutes or longer.

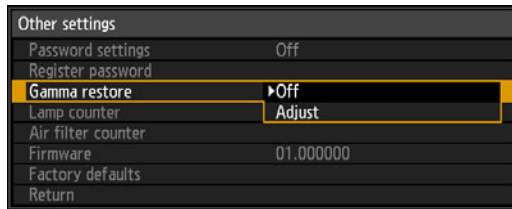

**Off** Returns to the factory default without performing Gamma restore.

**Adjust** Performs Gamma restore and applies the result.

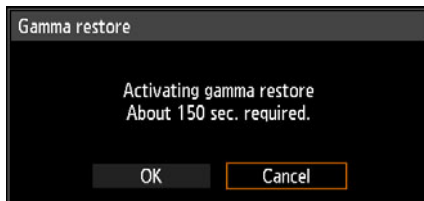

**OK** Gamma restore is performed.

**Cancel** Gamma restore is not performed.

- If Gamma restore is performed, the projected image will be adjusted for a period of approximately 150 seconds.
- To stop Gamma restore, press the **POWER** button or the **EXIT** button.



If Gamma restore is performed, the tone characteristics and achromatic color will be restored as close as possible to the condition when the projector was purchased, however it is not possible to restore it completely to the original condition. So the changing and turning color cannot be eliminated completely.

## Resetting the Lamp Counter

 > [System settings] > [Other settings] > [Lamp counter]

- HDMI     Component     LAN  
 Digital PC     Analog PC     USB

You can reset the lamp counter that indicates the time for lamp replacement.



Caution

Do not reset the lamp counter except when you have replaced the lamp. Otherwise, the lamp counter cannot indicate the correct timing for replacing the lamp.

For details of lamp replacement, refer to [page 201](#).

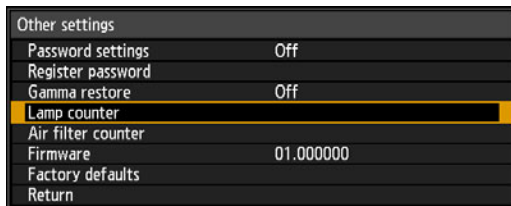

Select [Lamp counter] and press the **OK** button to display the lamp counter.



Select [Reset] and press the **OK** button.

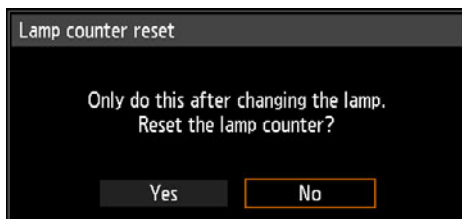

Select [Yes] on the screen for confirmation and press the **OK** button to reset the lamp counter. Press the **MENU** button or **EXIT** button.

## About the Display of the Lamp Counter

The lamp counter display is as follows.

### Less than 2,700 hours

Displayed as a **green** bar.

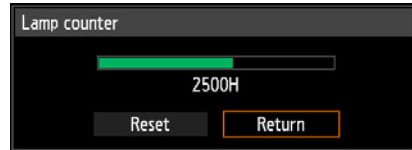

### 2,700 hours to less than 3,000 hours

Displayed as a **green and yellow** bar.

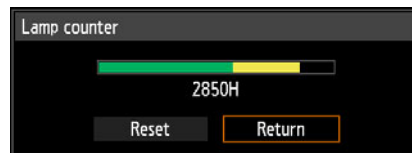

When the lamp hours are 2,700 hours to less than 3,000 hours, the message “Obtain a new lamp.” appears when power is turned on.



### Over 3,000 hours

Displayed as a **green, yellow and red** bar.

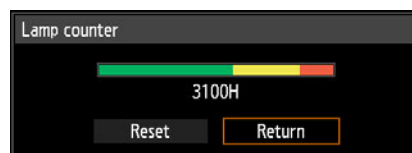

The message “Replace with the new lamp.” appears when power is turned on.

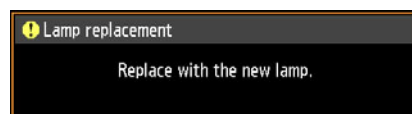



- The lamp counter provides an estimate of the time remaining until the lamp must be replaced. This value is based on the hours in use and the present load on the lamp.
- The number of hours indicated is equivalent to use under these conditions: [Vertical projection] (P152) set to [Off], and [Lamp mode] (P107) set to [Full power].

## Resetting the Air Filter Counter

**MENU** > [System settings] > [Other settings] > **[Air filter counter]**

- HDMI       Component       LAN  
 Digital PC       Analog PC       USB

**This resets the counter which reminds you of the time for cleaning and replacing the air filter.**



For details about how to replace or clean the filter, refer to [page 199](#).

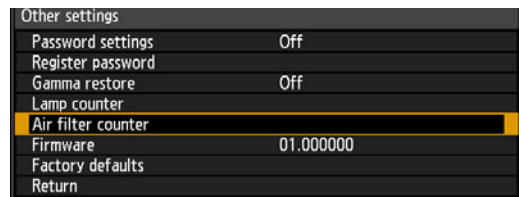

To view the air filter counter, press the **OK** button when [Air filter counter] is selected.



Select [Reset] and press the **OK** button.

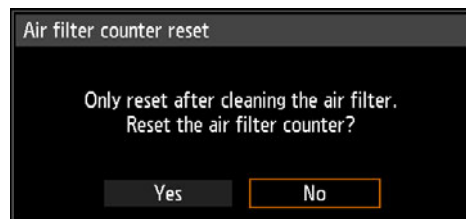

To reset the air filter counter, select [Yes] on the confirmation screen and press the **OK** button. Press the **MENU** button or **EXIT** button.



## Updating the Firmware

**MENU** > [System settings] > [Other settings] > [Firmware]

HDMI     Component     LAN  
 Digital PC     Analog PC     USB

Use a firmware update program stored on a USB flash drive to update the projector firmware. Download firmware updates from the Canon website and store them at the root directory on the USB flash drive.

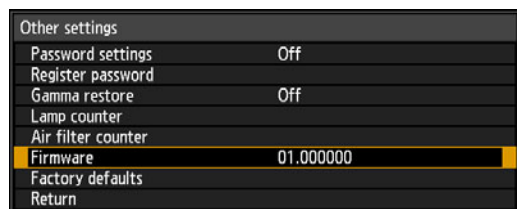

Select [Firmware], press the **OK** button, and check the firmware version displayed. Selecting [OK] will display an update confirmation screen. To update the firmware, select [Yes].

Firmware updating takes about three minutes. During the update, the LED indicator will flash in red. Do not turn off the projector while the LED is flashing.

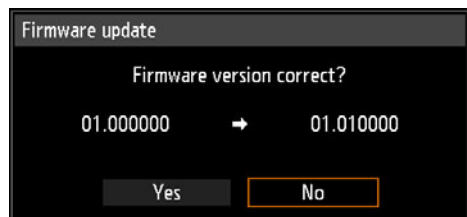

After the update, the projector will automatically turn itself off and enter standby mode.



- In some cases, it may not be possible to download the update. If so, contact the Canon Customer Support Center.
- This firmware version is for illustration only, and the actual number will be different.

## Resetting to the Default Setting

**MENU** > [System settings] > [Other settings] > [Factory defaults]

HDMI     Component     LAN  
 Digital PC     Analog PC     USB

You can reset the menu item settings and restore the system settings to the factory defaults.

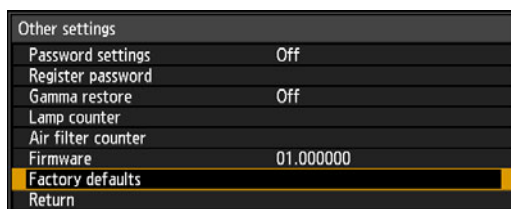

Select [Factory defaults] and press the **OK** button. The following screen for confirmation appears.

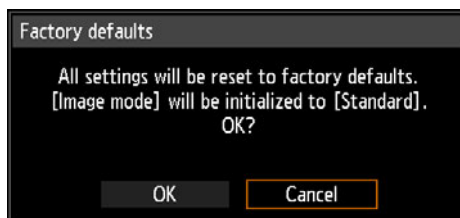

**OK** Settings are reset to default.

**Cancel** Settings are not reset to default.

- This function does not reset the values for [Lamp counter], [Language], [Remote control], [Input signal], [Network settings], [Air filter counter], [Professional settings] ([Micro-digital image shift], [Registration], [Fan mode], [Vertical projection], and [Edge blending]) and [Create profile].
- For factory defaults settings, refer to [P306 - P313](#).
- The contents of the user memory return to the conditions at the time it was saved. ([P98](#))

# Checking Projector Information

MENU > [Information]

- HDMI     Component     LAN  
 Digital PC     Analog PC     USB

You can check information about the signal types of the images projected and other information.

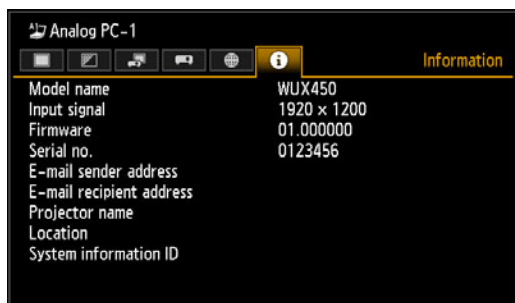

Information shown

Item	Explanation
<b>Model name</b>	WUX450/WX520/WUX400ST/WX450ST
<b>Input signal</b>	Details of the input signal currently selected Information such as the type, resolution, and frequency of the signal is displayed.
<b>Firmware</b>	Current firmware version
<b>Serial no.</b>	Serial number unique to this projector
<b>E-mail sender address*</b>	Sender e-mail address used for sending error mails (P187)
<b>E-mail recipient address*</b>	Displays [Already set] or [Not set] to show whether a recipient e-mail address has been set for receiving error mails. (P187)
<b>Projector name*</b>	Name which identifies this projector on the network
<b>Location*</b>	Location where the projector is installed
<b>System information ID</b>	System information. Normally this is not displayed.

\* Not displayed when network functions are [Off].

MULTIMEDIA PROJECTOR

**WUX450**

**WX520**

**WUX400ST**

**WX450ST**

# Installation and Maintenance



**Request projector installation from a qualified technician, if possible, or contact the Canon Customer Support Center. For ceiling installation in particular, always request installation from a qualified technician or contact the Canon Customer Support Center.**



# Installation

Table of Contents

Safety Instructions

Before Use

## Operation

Projecting an Image

Useful Functions Available  
During a Presentation

Setting Functions from  
Menus

## Installation and Maintenance

Installation

Connecting to a Network

Maintenance

## Networked Multi-Projection

Networked Multi-Projection  
Overview

Operation in Each Mode

Functions in All Modes

## Appendix

Other Information

Index

# Before Installation

## Precautions When Carrying/Shipping the Projector

Prepare the projector as described below before carrying it.



Caution

- Disconnect the cables connected to the projector. Carrying the projector with the cables attached may cause an accident.
- Retract the adjustable feet.
- Do not reuse any packaging or shock-absorbent materials that were supplied with the projector at the time of purchase for transporting or shipping the projector. Protection of the projector cannot be guaranteed if used packaging or shock-absorbent materials are reused. Fragments from shock-absorbent material may also enter the interior of the projector which could cause a malfunction.

## Precautions for Installation

Be sure to read “Safety Instructions” and “For Safe Use” (P16 – P29). Also take the following precautions during installation.



Caution

- Do not strike the projector or subject it to impact. Doing so may cause a malfunction.
- Do not install the projector so that it is inclined or standing vertically. The projector may tip over, causing a malfunction.
- Do not block the air intake or exhaust vents of the cooling fan. If the intake or exhaust vent is blocked, heat may accumulate inside the projector, causing a malfunction.

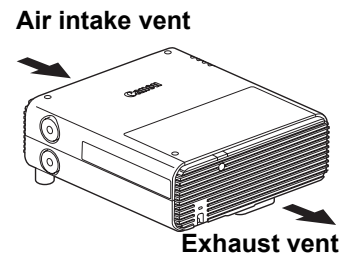

**Do Not Use in the Following Environments**

- Do not install the projector in a location that is damp, or where there is a lot of dust, oily smoke or tobacco smoke. Optical parts such as the lens and mirror may be stained, resulting in poor picture quality.
- Do not install the projector near high-voltage electrical power lines or an electrical power source. The projector may not operate correctly.
- Do not use the projector on a soft surface such as carpet or sponge mat, etc. Heat may accumulate inside the projector, causing a malfunction.
- Do not use the projector in a location that is subject to very high temperatures, very low temperatures, or high levels of humidity. Doing so may cause a malfunction. The temperature and humidity ranges for operation and the temperature range for storage are shown below.

Operating temperature	Operating humidity	Storage temperature
0°C (32°F) – 40°C (104°F)	Up to 85%	-10°C (14°F) – 60°C (140°F)

**Do Not Touch the Lens with Bare Hands**

Do not touch the lens with bare hands. Doing so may adversely affect picture quality.

**Allow a 30 Min. Warm Up before Focus Adjustment (P59), if Possible**

The focus position may not stabilize immediately after startup, due to lamp heat. When adjusting focus, it is also helpful to use the test pattern (10) (P291).

**Install at a Sufficient Distance from Walls and Other Obstructions**



Caution

If the air intake or exhaust vent is blocked, heat will accumulate inside the projector, possibly resulting in a shortened projector lifetime or a malfunction. Do not install in a closet, on a bookshelf, or in other narrow spaces with poor ventilation. Install in a well-ventilated location. (Ensure a minimum clearance of 50 cm (1.6 ft.) above, on both sides, and behind the projector.)

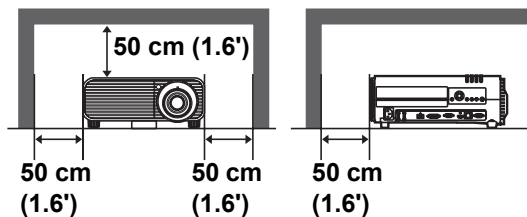
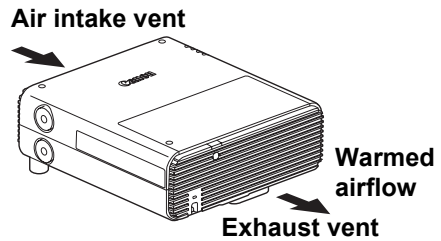

### ■ Be Careful of Condensation

If the temperature of the room rises suddenly, moisture in the air may condense on the projector lens and mirror, causing the image to become blurred. Wait until the condensation has evaporated for the image projected to return to normal.

### ■ At Altitudes above 2,300 m (7,545.8'), Adjust the Settings

Projector settings must be adjusted when using the projector at altitudes of 2,300 m (7,545.8') or higher. Specifically, refer to instructions for [Fan mode] (P152) in the [Install settings] menu.

### ■ When Using Mounted on the Ceiling



When the projector is used mounted on the ceiling or installed in a high location, it is necessary to periodically clean the air intake and exhaust vents, and the area around the air filter. If dust accumulates in the intake or exhaust vents, cooling performance will deteriorate, causing the internal temperature to rise and possibly resulting in a malfunction or fire. Use a vacuum cleaner or similar means to remove dust from the intake vent and exhaust vent.

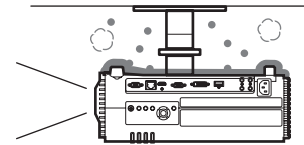



## ■ Install Facing in the Correct Direction



The projector can be installed facing any direction\*<sup>1</sup>, as shown below. However, projection upward (Ⓐ) or downward (Ⓑ) may shorten the useful life of the lamp. Installation in these orientations also requires projector settings adjustment. Specifically, for upward or downward projection, refer to instructions for [Vertical projection] (P152) in the [Install settings] menu.

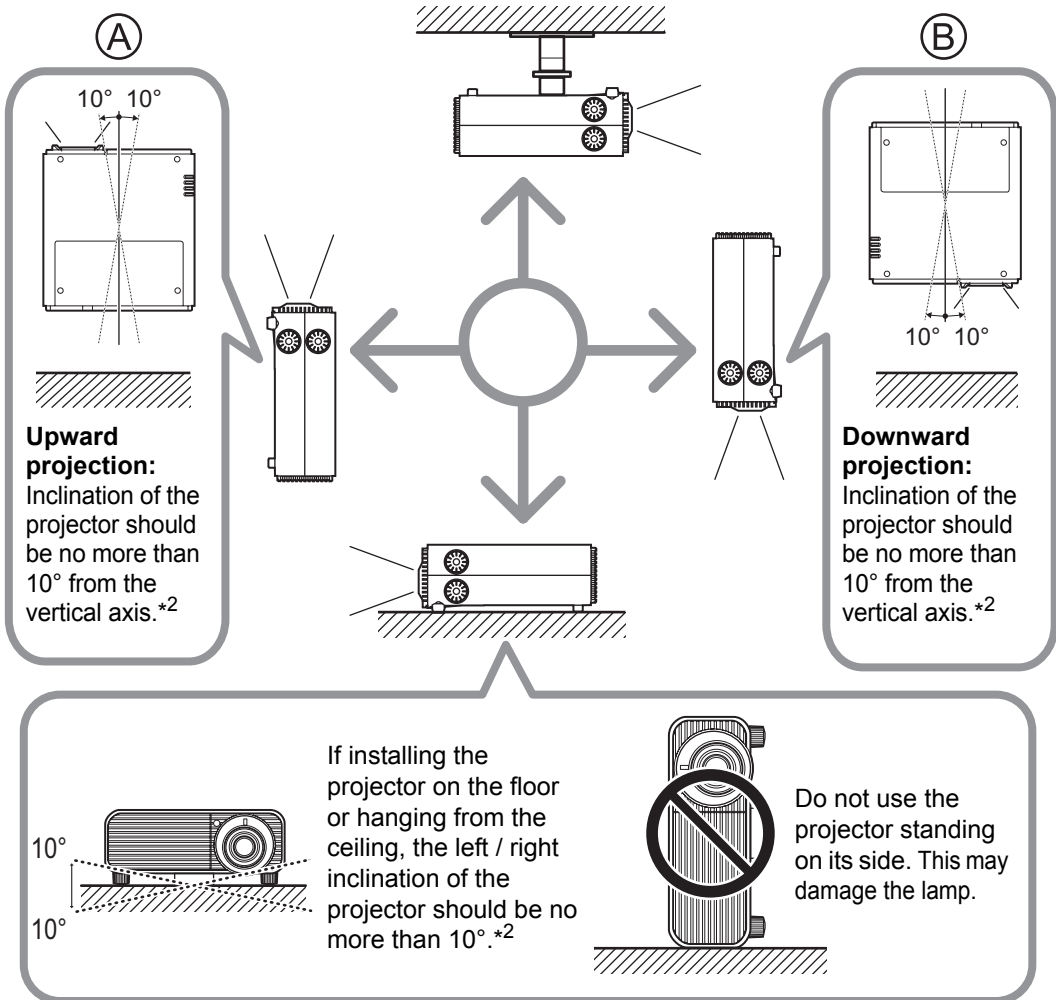

\*1 No optional accessories are available for installing the projector in ways other than ceiling installation (P39, P132, P305).

\*2 Failure to do so may damage the lamp.



When installing the projector facing upward or downward, specify which way the projector is facing in [Install settings] > [Professional settings] > [Vertical projection]. (P152)

# Installation Procedure

## Setting Up the Projector

### ■ Positioning the Projector in Front of the Screen

Place the projector in front of the screen.

- ◆ On some screens, colors may appear distorted when images are viewed from the side, but this does not indicate a problem with the projector. For best results, use a matte screen with a wide viewing angle (WUX400ST/WX450ST).

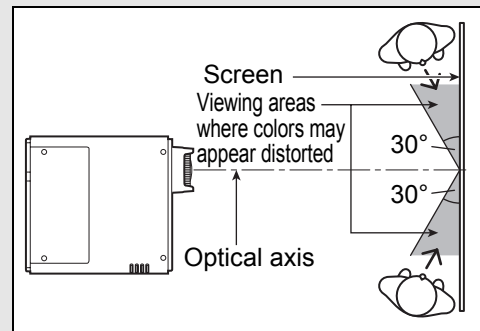

- To avoid keystone distortion, install the projector so that it is at right angles to the screen.
- The screen must not be exposed to direct sunlight or light from lighting equipment. In a bright room, it is recommended that lights be turned off, curtains be drawn, and other steps taken to make the screen easier to see.

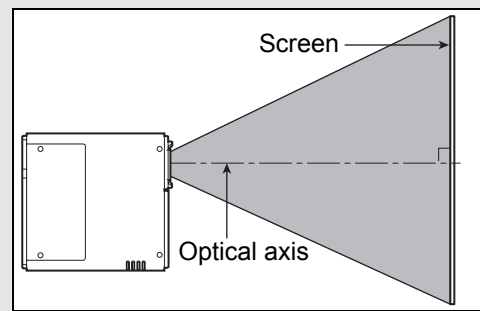

### ■ Floor Installation

To adjust the projection position when the projector is installed on the floor, use the lens shift function (P58 and P134) to adjust up / down / left / right. You can also use the adjustable feet to incline the projector upward by up to 6°.

For information about the relationship between screen size and projection distance, refer to [page 133](#).

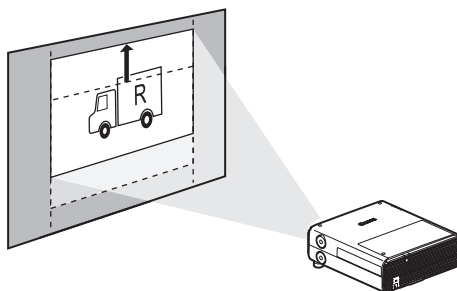

Lens shift

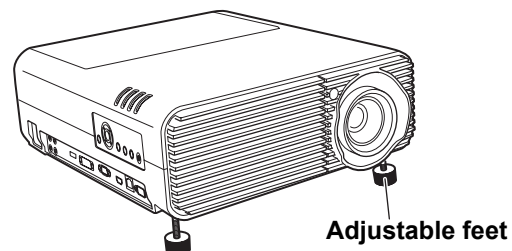

Adjustable feet

### ■ Upward-Tilted Installation

To correct keystone distortion when the projector is tilted upward (using adjustable feet, for example), perform keystone correction (P150) or corner adjustment (P150).

### ■ Projection from High Surfaces

For projection from a shelf or other high surface, the projector can be installed upside-down and the projected image inverted. In this case, attach the option feet on top of the projector.

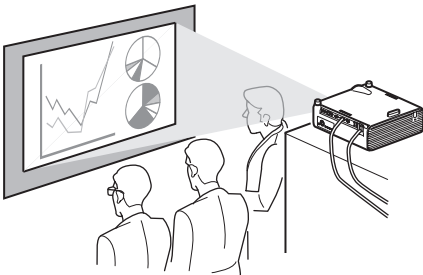

**When setting the projector on a high surface for projection, be sure the surface is flat and stable. Failure to do so could result in the projector falling down and causing an accident or personal injury.**

### Attaching Option Feet (RS-FT01, Sold Separately)

Remove the hole caps and screw the option feet into the holes. The caps are located at four positions on top of the projector. They are removed differently depending on their position.

Top

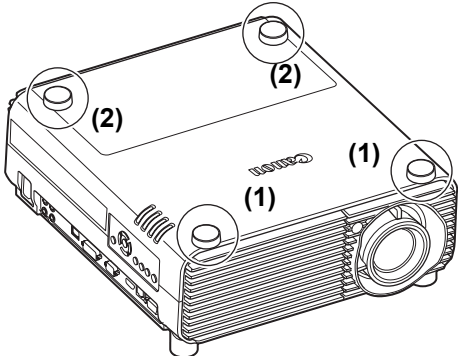

### Removing hole caps labeled (1)

Pry off the caps by inserting a slender tool such as a flat screwdriver in the depression.

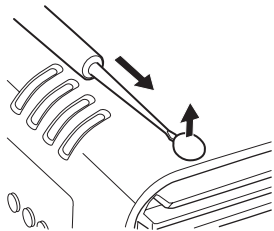

## Installation Procedure

### Removing hole caps labeled (2)

Open the lamp cover and use a screwdriver or similar tool to push off the caps from below.

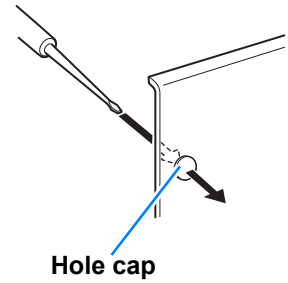

- Keep the caps in a safe place to avoid losing them.
- The option feet can be used in conjunction with the adjustable feet. When changing the projection position with adjustable feet, you can make the projector more stable by attaching option feet to the two holes toward the back of the bottom surface.

## ■ Ceiling Mounting or Rear Projection

You can mount the projector on the ceiling (ceiling mounting) with it turned upside down or place it behind the screen (rear projection) if you use a translucent screen.

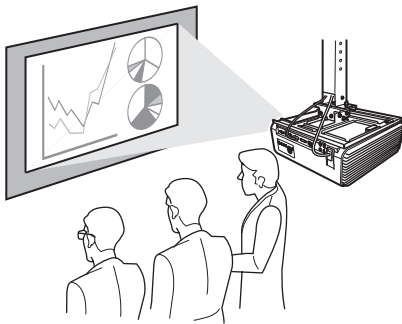

Ceiling mounting

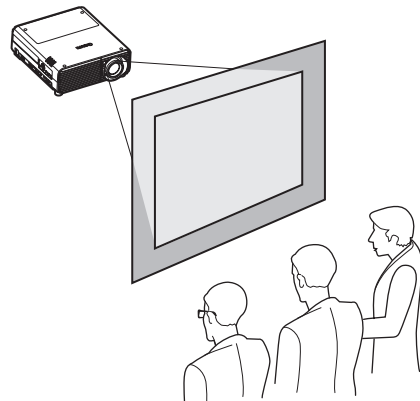

Rear projection

Make sure to use the optional ceiling attachment. For the ceiling attachment, refer to “Option” (P305). For details, refer to the assembly and installation manual provided with the ceiling attachment.

# Relationship of Image Size to Projection Distance

The size of projected images is determined by zooming, relative to the distance from the projector to the screen. (Optical zooming on the WUX450/WX520, and electronic zooming on the WUX400ST/WX450ST.) Refer to the following table and decide the distance between the projector and screen.

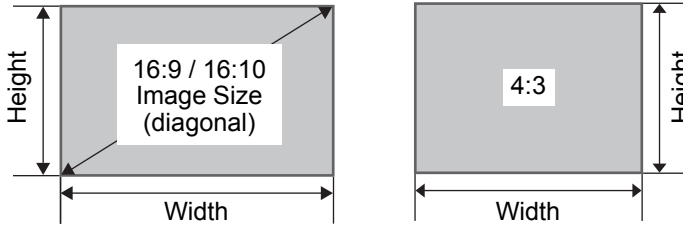

## WUX450/WX520

Projection distance [m (feet)]

Image Size (Dia.)	WUX450						WX520					
	16:10		16:9		4:3		16:10		16:9		4:3	
	Wide limit	Tele limit	Wide limit	Tele limit	Wide limit	Tele limit	Wide limit	Tele limit	Wide limit	Tele limit	Wide limit	Tele limit
40	1.2 (3.9)	2.2 (7.2)	1.2 (3.9)	2.2 (7.2)	1.4 (4.6)	2.4 (7.9)	1.2 (3.9)	2.2 (7.2)	1.3 (4.3)	2.3 (7.5)	1.4 (4.6)	2.5 (8.2)
50	1.5 (4.9)	2.7 (8.9)	1.5 (4.9)	2.8 (9.1)	1.7 (5.6)	3.1 (10.2)	1.5 (4.9)	2.8 (9.1)	1.6 (5.2)	2.8 (9.1)	1.7 (5.6)	3.1 (10.2)
60	1.8 (5.9)	3.2 (10.5)	1.9 (6.2)	3.3 (10.8)	2.0 (6.6)	3.7 (12.1)	1.8 (5.9)	3.3 (10.8)	1.9 (6.2)	3.4 (11.2)	2.1 (6.7)	3.8 (12.5)
80	2.4 (7.9)	4.3 (14.1)	2.5 (8.2)	4.4 (14.4)	2.7 (8.9)	4.9 (16.1)	2.5 (8.2)	4.4 (14.4)	2.5 (8.2)	4.6 (15.1)	2.8 (9.2)	5.0 (16.4)
100	3.0 (9.8)	5.4 (17.7)	3.1 (10.2)	5.5 (18)	3.4 (11.2)	6.1 (20)	3.1 (10.1)	5.5 (18.7)	3.2 (10.5)	5.7 (18.7)	3.5 (11.5)	6.3 (20.7)
150	4.5 (14.8)	8.1 (26.6)	4.6 (15.1)	8.3 (27.2)	5.1 (16.7)	9.2 (30.2)	4.6 (15.1)	8.3 (27.2)	4.7 (15.4)	8.5 (27.9)	5.2 (17.1)	9.4 (30.8)
200	6.0 (19.7)	10.8 (35.4)	6.2 (20.3)	11.1 (36.4)	6.8 (22.3)	12.2 (40)	6.2 (20.3)	11.1 (36.4)	6.3 (20.7)	11.4 (37.4)	7.0 (23)	12.6 (41.3)
250	7.5 (24.6)	13.5 (44.3)	7.7 (25.3)	13.9 (45.6)	8.5 (27.9)	15.3 (50.2)	7.7 (25.3)	13.9 (45.56)	7.9 (25.9)	14.2 (46.6)	8.7 (28.5)	15.7 (51.5)
300	9.0 (29.5)	16.2 (53.1)	9.3 (30.5)	16.6 (54.5)	10.2 (33.5)	18.3 (60)	9.2 (30.2)	16.6 (54.5)	9.5 (31.2)	17.1 (56.1)	10.5 (34.4)	18.8 (61.7)

## WUX400ST/WX450ST

Projection distance [m (feet)]

Image Size (Dia.)	WUX400ST			WX450ST		
	16:10	16:9	4:3	16:10	16:9	4:3
30	0.35 (1.15)	0.36 (1.18)	0.40 (1.31)	0.36 (1.18)	0.37 (1.21)	0.41 (1.35)
40	0.47 (1.54)	0.49 (1.61)	0.54 (1.77)	0.49 (1.61)	0.50 (1.64)	0.55 (1.80)
50	<b>0.60 (1.97)</b>	<b>0.61 (2.00)</b>	<b>0.68 (2.23)</b>	<b>0.61 (2.00)</b>	<b>0.63 (2.07)</b>	<b>0.69 (2.26)</b>
60	<b>0.72 (2.36)</b>	<b>0.74 (2.43)</b>	<b>0.81 (2.66)</b>	<b>0.74 (2.43)</b>	<b>0.76 (2.49)</b>	<b>0.83 (2.72)</b>
80	<b>0.96 (3.15)</b>	<b>0.99 (3.25)</b>	<b>1.09 (3.58)</b>	<b>0.98 (3.22)</b>	<b>1.01 (3.31)</b>	<b>1.12 (3.67)</b>
100	<b>1.20 (3.93)</b>	<b>1.24 (4.07)</b>	<b>1.36 (4.46)</b>	<b>1.23 (4.04)</b>	<b>1.27 (4.17)</b>	<b>1.40 (4.59)</b>
150	<b>1.81 (5.94)</b>	<b>1.86 (6.10)</b>	<b>2.05 (6.73)</b>	<b>1.86 (6.10)</b>	<b>1.91 (6.27)</b>	<b>2.10 (6.89)</b>
200	<b>2.42 (7.94)</b>	<b>2.49 (8.17)</b>	<b>2.74 (8.99)</b>	<b>2.48 (8.14)</b>	<b>2.55 (8.37)</b>	<b>2.81 (9.22)</b>
250	3.03 (9.94)	3.11 (10.20)	3.43 (11.25)	3.10 (10.17)	3.19 (10.47)	3.52 (11.55)
300	3.64 (11.94)	—	—	3.73 (12.24)	—	—

The recommended range for the WUX400ST/WX450ST applies to 50-200 inch images.

## ■ Lens Shift Function

You can reposition the image in all directions by turning the lens shift dials on the side of the projector, which moves the lens up, down, left, or right. For instructions, refer to “Lens Shift Control” (P45).

## ■ Amount of Lens Shift

The amount of lens shift is indicated as a percentage relative to the image height and width.

The lens shift ranges for each model of projector are as follows.

	<b>WUX450</b>	<b>WX520</b>	<b>WUX400ST</b>	<b>WX450ST</b>
A (Amount of shift up)	+60%	+62%	+75%	+77%
B (Amount of horizontal shift)	±10%	±10%	±10%	±10%

The projector supports vertical and horizontal lens shift. Performance using lens shift is ensured within the recommended range described below. Using lens shift outside of this range may cause problems such as peripheral dimness or lower resolution. In this case, adjust lens shift to within the recommended range.

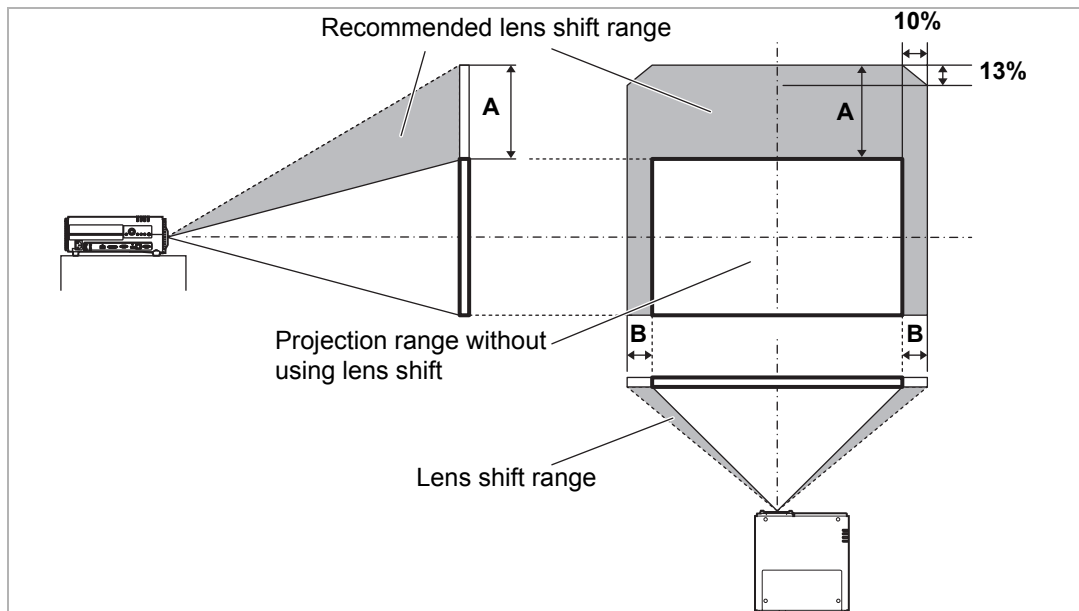

Maximum upward (A) and horizontal (B) movement using lens shift (reference values, in cm)

**WUX450/WX520**

Image Size (Dia.)	WUX450						WX520					
	16:10		16:9		4:3		16:10		16:9		4:3	
	A	B	A	B	A	B	A	B	A	B	A	B
40	32 (12.6)	9 (3.5)	30 (11.8)	9 (3.5)	37 (14.6)	8 (3.1)	33 (13.0)	9 (3.5)	31 (12.2)	9 (3.5)	38 (15.0)	8 (3.1)
60	48 (18.9)	13 (5.1)	45 (17.7)	13 (5.1)	55 (21.7)	12 (4.7)	48 (18.9)	13 (5.1)	45 (17.7)	13 (5.1)	55 (21.7)	12 (4.7)
80	65 (25.6)	17 (6.7)	60 (23.6)	18 (7.1)	73 (28.7)	16 (6.3)	65 (25.6)	17 (6.7)	60 (23.6)	18 (7.1)	73 (28.7)	16 (6.3)
100	81 (31.9)	22 (8.7)	75 (29.5)	22 (8.7)	91 (35.8)	20 (7.9)	81 (31.9)	22 (8.7)	75 (29.5)	22 (8.7)	91 (35.8)	20 (7.9)
150	121 (47.6)	32 (12.6)	112 (44.1)	33 (13.0)	137 (53.9)	30 (11.8)	121 (47.6)	32 (12.6)	112 (44.1)	33 (13.0)	137 (53.9)	30 (11.8)
200	162 (63.8)	43 (16.9)	149 (58.7)	44 (17.3)	183 (72.0)	41 (16.1)	162 (63.8)	43 (16.9)	149 (58.7)	44 (17.3)	183 (72.0)	41 (16.1)
250	202 (79.5)	54 (21.3)	187 (73.6)	55 (21.7)	229 (90.2)	51 (20.1)	202 (79.5)	54 (21.3)	187 (73.6)	55 (21.7)	229 (90.2)	51 (20.1)
300	242 (95.3)	65 (25.6)	224 (88.2)	66 (26.0)	274 (107.9)	61 (24.0)	242 (95.3)	65 (25.6)	224 (88.2)	66 (26.0)	274 (107.9)	61 (24.0)

**WUX400ST/WX450ST**

Image Size (Dia.)	WUX400ST						WX450ST					
	16:10		16:9		4:3		16:10		16:9		4:3	
	A	B	A	B	A	B	A	B	A	B	A	B
30	30 (11.8)	6 (2.4)	28 (11.0)	7 (2.8)	34 (13.4)	6 (2.4)	31 (12.2)	6 (2.4)	29 (11.4)	7 (2.8)	35 (13.8)	6 (2.4)
40	40 (15.6)	9 (3.5)	37 (14.6)	9 (3.5)	46 (18.1)	8 (3.2)	41 (16.1)	9 (3.5)	38 (15.0)	9 (3.5)	47 (18.5)	8 (3.2)
50	50 (19.7)	11 (4.3)	47 (18.5)	11 (4.3)	57 (22.4)	10 (3.9)	52 (20.5)	11 (4.3)	48 (18.9)	11 (4.3)	59 (23.2)	10 (3.9)
60	61 (24.0)	13 (5.1)	56 (22.1)	13 (5.1)	69 (27.2)	12 (4.7)	62 (24.4)	13 (5.1)	58 (22.8)	13 (5.1)	70 (27.6)	12 (4.7)
80	81 (31.9)	17 (6.7)	75 (29.5)	18 (7.1)	91 (35.8)	16 (6.3)	83 (32.7)	17 (6.7)	77 (30.3)	18 (7.1)	94 (37.0)	16 (6.3)
100	101 (39.8)	22 (8.7)	93 (36.6)	22 (8.7)	114 (44.9)	20 (7.9)	104 (40.9)	22 (8.7)	96 (37.8)	22 (8.7)	117 (46.1)	20 (7.9)
150	151 (59.5)	32 (12.6)	140 (55.1)	33 (13.0)	171 (67.3)	30 (11.8)	155 (61.0)	32 (12.6)	144 (56.7)	33 (13.0)	176 (69.3)	30 (11.8)
200	202 (79.5)	43 (16.9)	187 (73.6)	44 (17.3)	229 (90.2)	41 (16.1)	207 (81.5)	43 (16.9)	192 (75.6)	44 (17.3)	235 (92.5)	41 (16.1)
250	252 (99.2)	54 (21.3)	233 (91.7)	55 (21.7)	286 (112.6)	51 (20.1)	259 (102.0)	54 (21.3)	240 (94.5)	55 (21.7)	293 (115.4)	51 (20.1)
300	303 (119.3)	65 (25.6)	280 (110.2)	66 (26.0)	343 (135.0)	61 (24.0)	311 (122.4)	65 (25.6)	288 (113.4)	66 (26.0)	352 (138.6)	61 (24.0)



- (A) values are the approximate vertical lens shift distance from the lowest image position.
- (B) values are the approximate horizontal lens shift distance from the central image position within the range supported for lens shift.



- Watch projected images as you perform lens shift adjustment.
- When the image no longer moves, you have reached the limit of the lens shift range. Do not turn the lens shift dial excessively in one direction, which may damage the projector.

# Connection Procedure

## Connectable Equipment and Input Terminals

<b>HDMI</b>	Use this name to select the image input.	↓ Direction of signal and data flow  (Pxxx) indicates the page(s) to refer to.
<b>HDMI Terminal</b>	The name of the terminal to which to connect equipment	

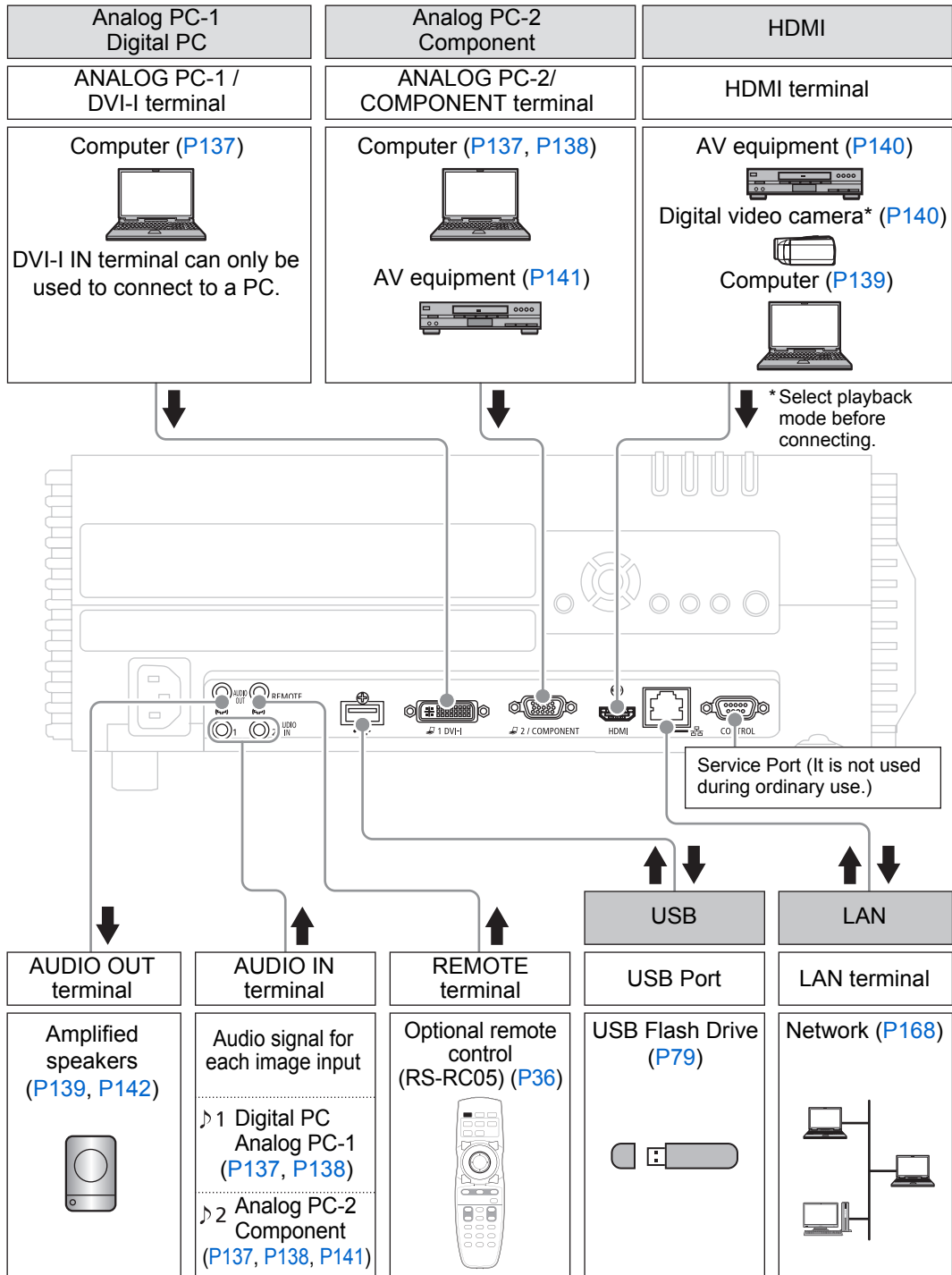



# Connecting a Computer

Connect the projector to the computer.

A digital connection (P138) is recommended when projecting an image in high quality.

When using a computer with an HDMI output terminal, a digital connection (P139) can be made using an HDMI cable.

**!** Before connecting the cables, turn off both the projector and computer.  
 Caution

## ■ Connecting to RGB Monitor Output Terminal (Analog Connection)

Connecting with a computer cable (Input signal type: [Analog PC-2] P53)

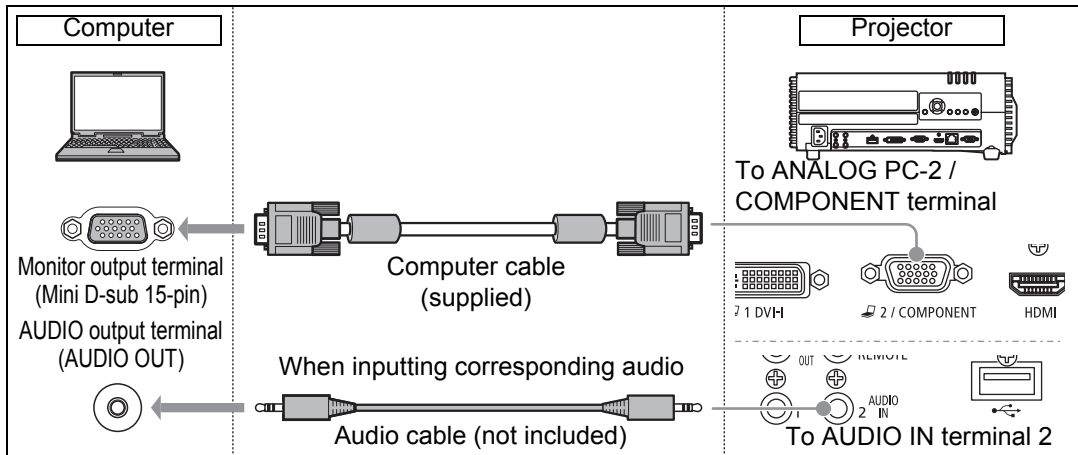

Connecting with VGA-DVI cable (Input signal type: [Analog PC-1] P53)

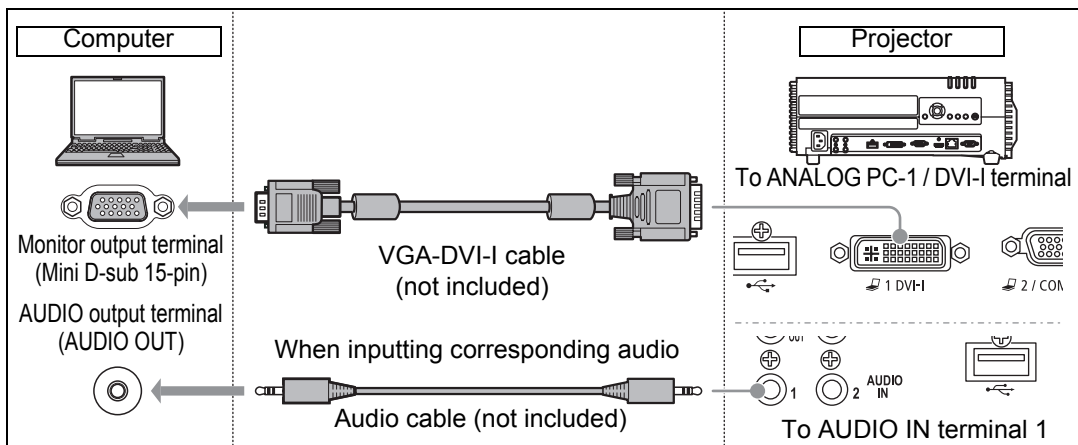

## Connection Procedure



- Use a VGA-DVI-I cable in which all pins are connected. If the cable is a type in which all pins are not connected, the image may not be correctly displayed.
- Use an audio cable without a built-in resistor. Using an audio cable with a built-in resistor will reduce the audio volume.
- The AUDIO IN terminal can be changed in the Audio in terminal select screen (P153).

### Connecting with a BNC cable (Input signal type: [Analog PC-2] P53)

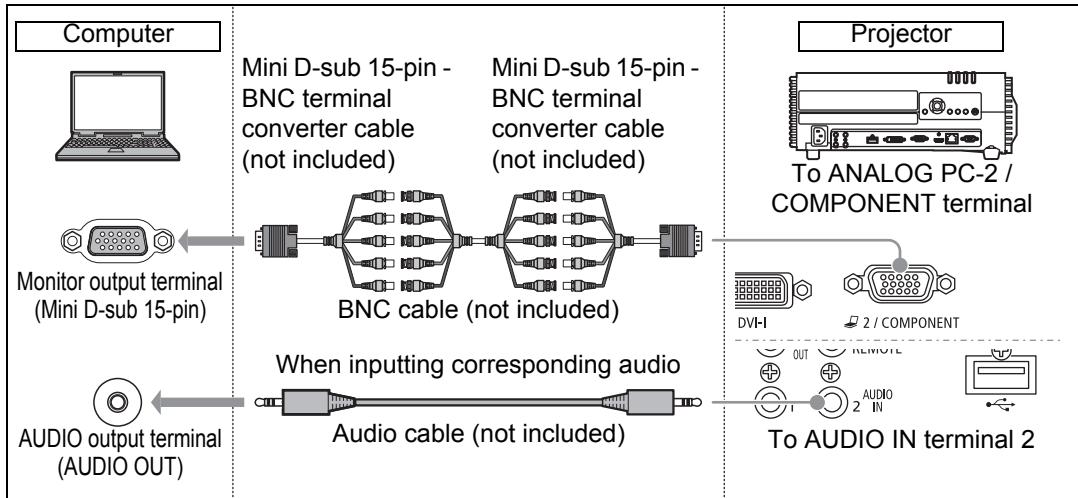

- A signal with a dot clock higher than 162 MHz cannot be projected.
- Use an audio cable without a built-in resistor. Using an audio cable with a built-in resistor will reduce the audio volume.
- The AUDIO IN terminal can be changed in the Audio in terminal select screen (P153).

## ■ Connecting to DVI Monitor Output Terminal (Digital Connection)

### Connecting with a DVI cable (Input signal type: [Digital PC] P53)

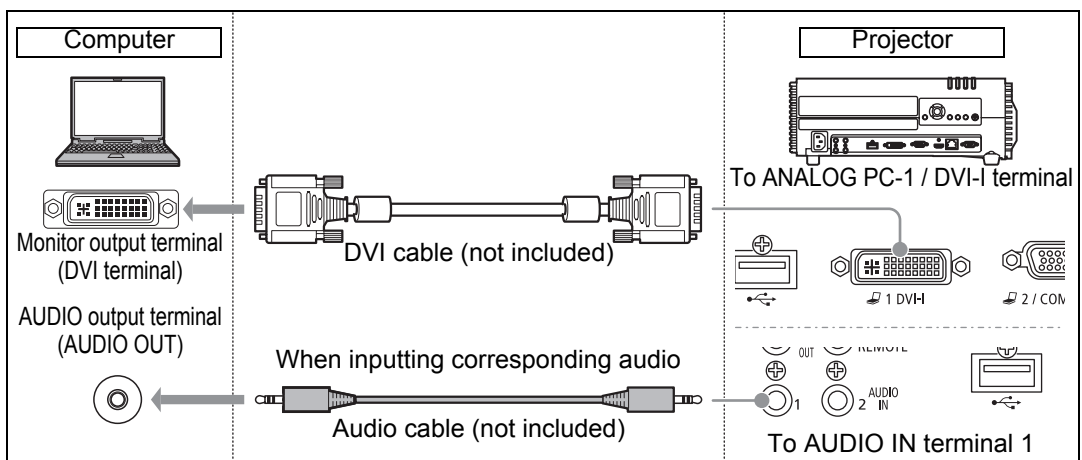

- Use an audio cable without a built-in resistor. Using an audio cable with a built-in resistor will reduce the audio volume.
- The AUDIO IN terminal can be changed in the Audio in terminal select screen (P153).

### ■ Connecting with an HDMI cable (Input signal type: [HDMI] P53)

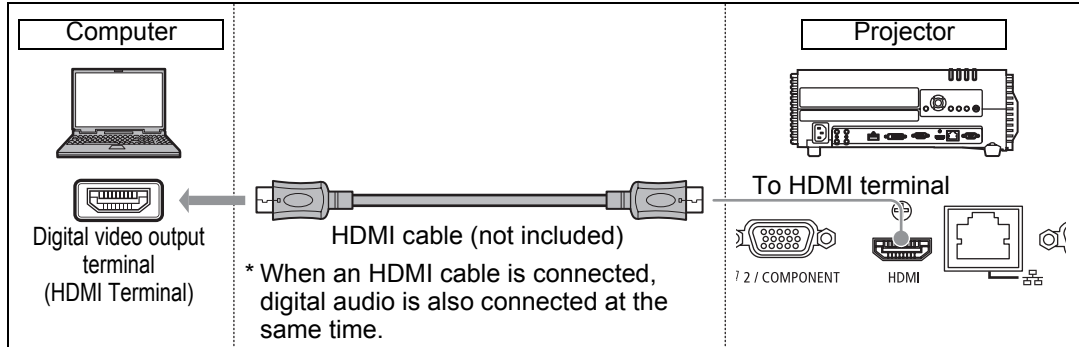

### ■ Outputting Audio to Speakers

It is possible to output audio from the projected images to amplified speakers.

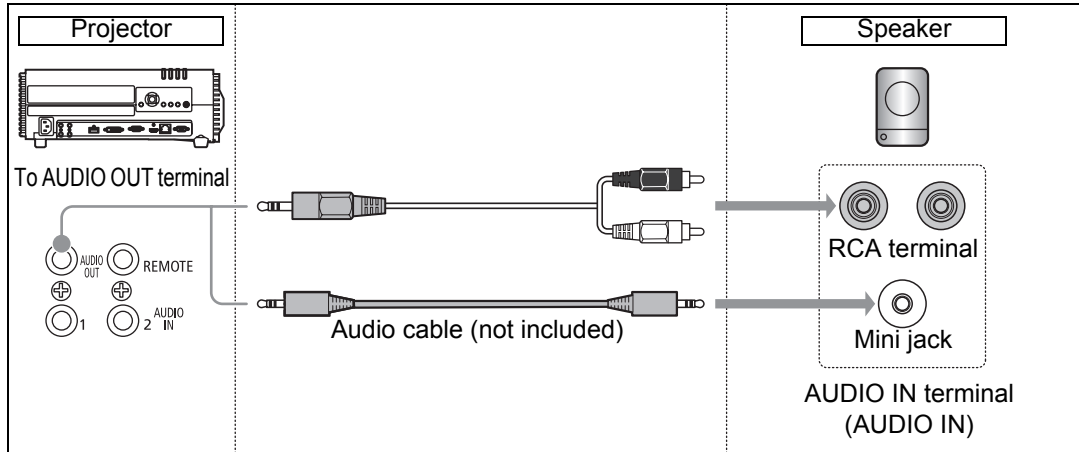

- Use an audio cable without a built-in resistor. Using an audio cable with a built-in resistor will reduce the audio volume.

## Connecting AV Equipment

Connect the projector and AV equipment.  
The description provided here is one example. For more detailed information, refer to the manual for the connected AV equipment.

**!** Before connecting the cables, turn off both the projector and AV equipment.  
Caution

### ■ Connecting to Digital Video Output Terminal (Digital Connection)

Connecting with an HDMI cable (Input signal type: [HDMI] P53)

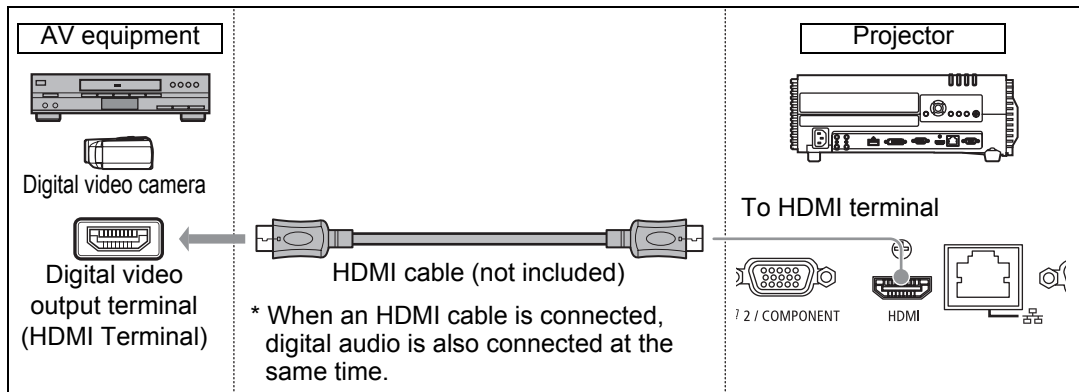

## ■ Connecting to Analog Video Output Terminal (Analog Connection)

### Connecting with a component cable (Input signal type: [Component] P53)

Component video signals from AV equipment can be supplied to the projector by connecting the component cable to the projector's COMPONENT terminal.

Use a commercially available component cable (not included) that fits the terminal type of the AV equipment to create a relay connection.

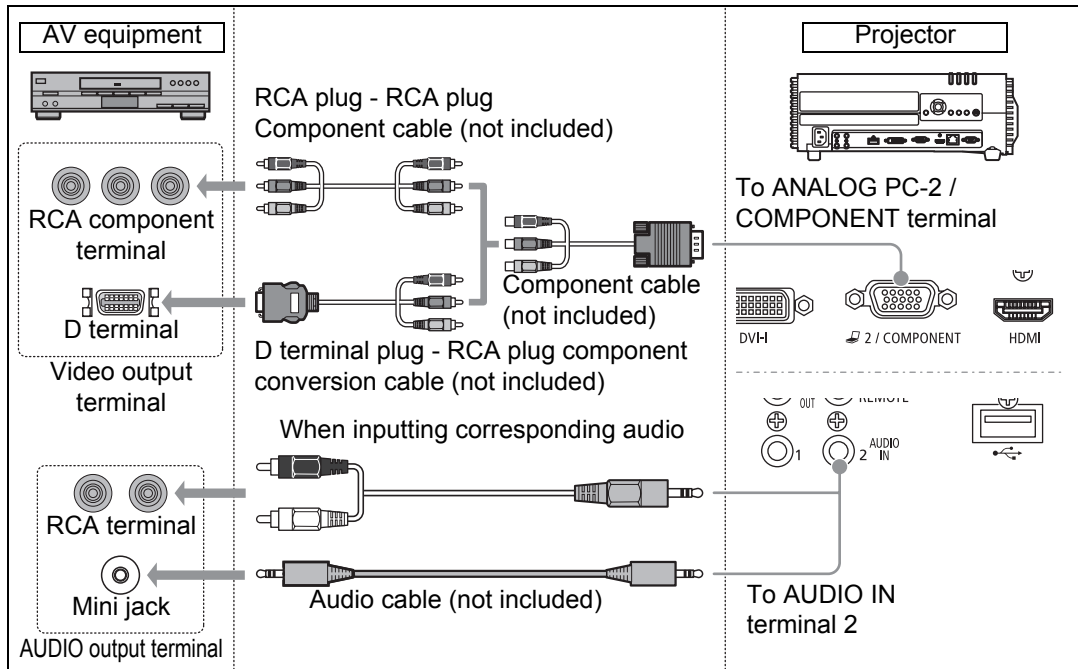

- Use an audio cable without a built-in resistor. Using an audio cable with a built-in resistor will reduce the audio volume.
- The AUDIO IN terminal can be changed in the Audio in terminal select screen (P153).

### ■ Outputting Audio to Speakers

It is possible to output audio from the projected images to AV equipment or amplified speakers.

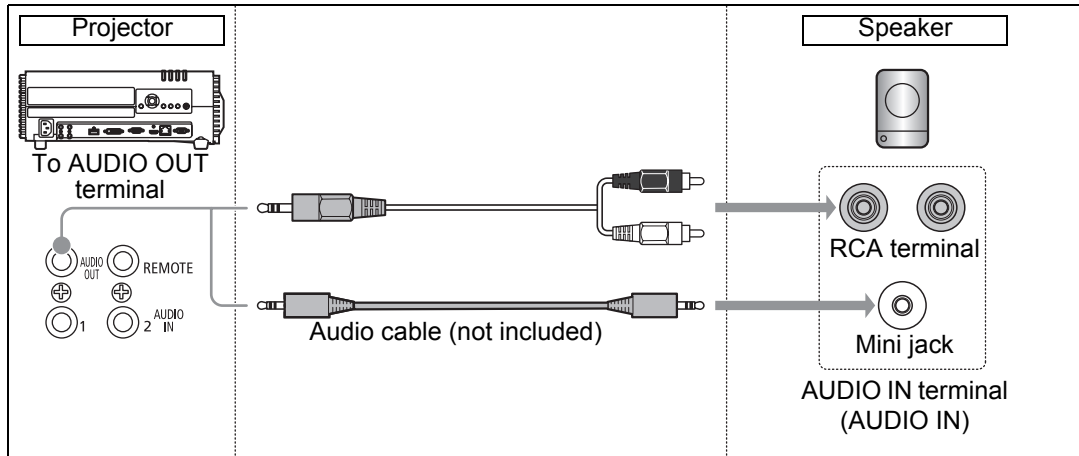

Use an audio cable without a built-in resistor. Using an audio cable with a built-in resistor will reduce the audio volume.

## Plugging the Projector In

Connect the power cord to the projector and plug it in.

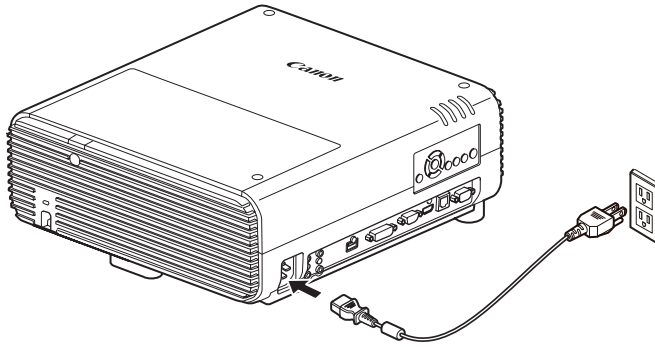

Warning

**Connect the ground terminal on the power plug to ground. Not doing so could result in an electric shock. Additionally, it may cause computers to be affected by electromagnetic interference and impair TV and radio reception.**



- Fully insert the power cord plug into the socket.
- After turning off the projector, wait at least 5 minutes before turning it on again. It may shorten the lamp life if you turn on the projector immediately after turning it off.



Unplug the power cord when the projector is not in use.

# Starting Projection

## Starting and Stopping Projection

### ■ Starting Projection

Press the **POWER** button on the remote control or on the projector.  
The [POWER ON] indicator initially flashes green, after which it remains lit.

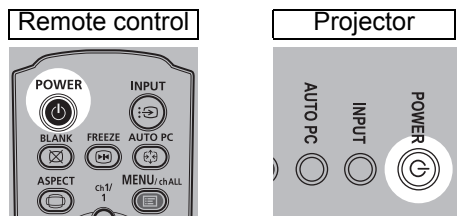

### ■ Stopping Projection

Press the **POWER** button on the remote control or on the projector twice.

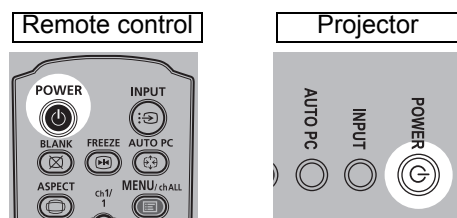

### ■ When the Language Selection Screen Appears

A screen appears when the projector is turned on for the first time. You can select a language to be used by the projector for displaying menus and messages in the window. Select the desired language with the pointer buttons and press the **OK** button.

You can change the language from the menu at a later time. (P115)

If the language selection screen is out of focus, adjust the focus. (P59)

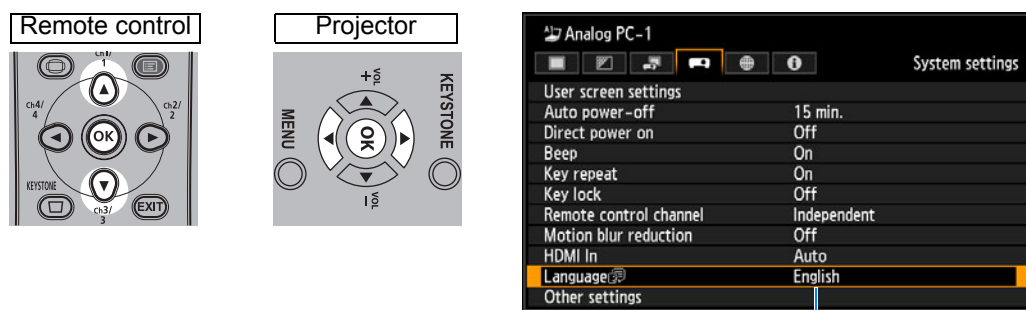

An item highlighted in orange will be selected.

### ■ When the Password Input Screen Appears

If you have set a password, the password input screen appears. Enter your password. (P116)



## ■ When “No signal” Appears

With a notebook computer, the user must turn on the external monitor output. (P145)

Press the **INPUT** button to select the input signal. (P54)

## ■ When Notebook Computer Screen Does Not Appear

Set your notebook computer to output signals to an external monitor. For more details, refer to “Changing Notebook Computer Screen Output” below.

## ■ Adjusting Image

- Set the display resolution of the computer to the highest resolution or the resolution closest to that setting. (P55)
- Use the auto PC function to adjust shift in computer image or the flickering of the screen. (P57)
- Adjust the size of projected images by zooming. The WUX450/WX520 uses optical zoom (P57), and the WUX400ST/WX450ST uses electronic zoom. (P149)
- If the image is blurry, use the focus ring to adjust focus. (P59)
- Correct any keystone distortion by pressing the **KEYSTONE** button. (P68)
- Select the aspect ratio of the projected image (screen aspect) or a screen mode (aspect) according to the aspect ratio of the screen, type of input image signal etc. (P60 – P67)
- Select an image mode depending on the projected image. (P71)

## Changing Notebook Computer Screen Output

For projection from a notebook computer, the computer settings must be adjusted to switch display output.

This operation is not required for a desktop computer.

## ■ Turning on External Monitor Output

You can turn on the external monitor output via keyboard operation.

To turn on the external monitor output with most computers, press the function key ([F1] to [F12]) which is marked with the external monitor icon while holding down the [Fn] key.

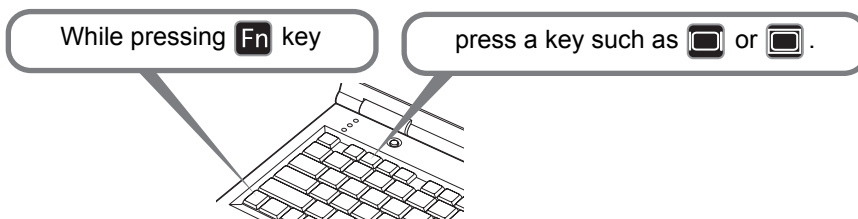

- The function key you use and the method used to turn on the external monitor output vary depending on the model. For details, see the manual for your notebook computer.
- With Windows 7, you can turn on image output by holding down the Windows logo key and pressing the [P] key.

# Installation-Related Menu Settings

## Locking Installation Settings

**MENU** > [Install settings] > [**Positional lock**]

- HDMI     Component     LAN  
 Digital PC     Analog PC     USB

Operation of installation related functions can be prohibited.

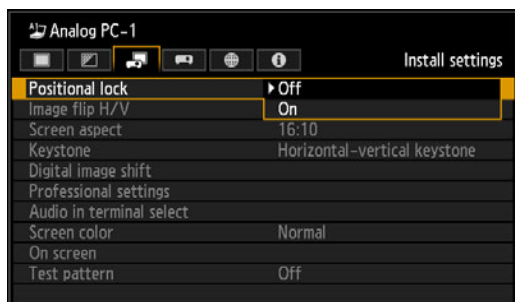

- 
- Off**    The positional lock is not used.
- 
- On**    Installation related functions cannot be used.
- 

Press the **OK** button to accept your setting and then press the **MENU** button or **EXIT** button.

- The factory default is [Off].
- Locking applies to the following settings: screen aspect, keystone adjustment, digital image shift, horizontal/vertical image flip, and professional settings.

## Flipping Image Display

**MENU** > [Install settings] > [**Image flip H/V**]

- HDMI     Component     LAN  
 Digital PC     Analog PC     USB

Select this setting if you want to hang the projector from the ceiling or project an image from behind the screen.

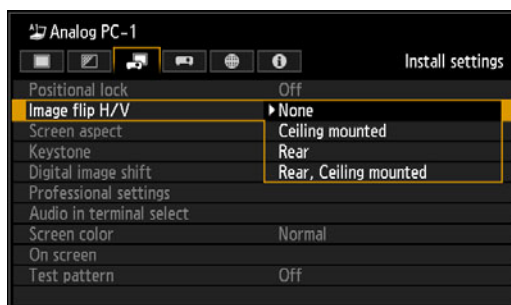

- 
- None**    Select this to project an image normally.
- 
- Ceiling mounted**    Select this to project an image with the projector hung from the ceiling.  
The projected image is inverted in both vertical and horizontal directions.
- 
- Rear**    Select this to project an image from behind the screen.  
The projected image is inverted in the horizontal direction.
- 
- Rear, Ceiling mounted**    Select this to project an image from behind the screen with the projector hung from the ceiling.  
The projected image is inverted in the vertical direction.
- 

Press the **OK** button to accept your setting and then press the **MENU** button or **EXIT** button.

- [None] is the factory default.

### Normal (None)

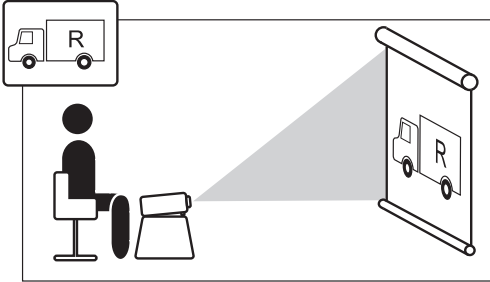

### Ceiling Mounting

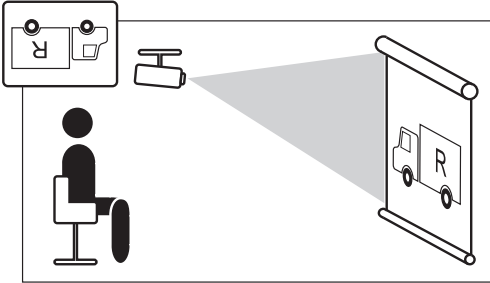

### Rear projection

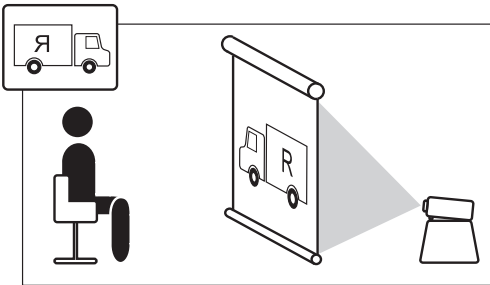

### Rear, Ceiling Mounting

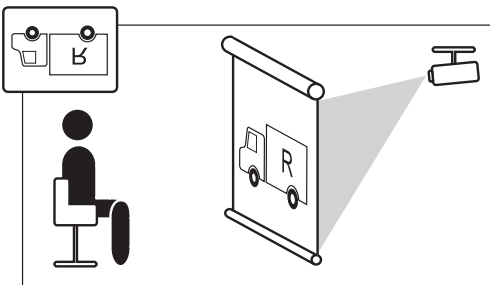

- To hang the projector from the ceiling, use the optional bracket. Contact the Canon Customer Support Center for more detailed information.
- If you flip the image, the keystone distortion adjustment will be reset.

## Specifying the Screen Aspect

 > [Install settings] > **[Screen aspect]**

- HDMI       Component       LAN  
 Digital PC       Analog PC       USB

Select according to the aspect ratio of the projection screen. (P60)

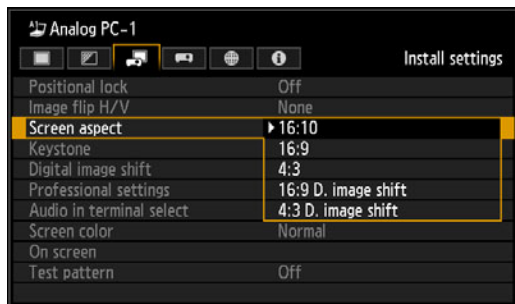

<b>16:10</b>	Select this when you use a screen with an aspect ratio of 16:10.
<b>16:9</b>	Select this when you use a screen with an aspect ratio of 16:9.
<b>4:3</b>	Select this when you use a screen with an aspect ratio of 4:3.
<b>16:9 D. image shift</b>	Select this when you use a screen with an aspect ratio of 16:9. Keystone correction cannot be performed in this mode. However, it is possible to move the image up / down when projecting level. For details about how to move the image, refer to <a href="#">page 63</a> .
<b>4:3 D. image shift</b>	Select this when you use a screen with an aspect ratio of 4:3. Keystone correction cannot be performed in this mode. However, it is possible to move the image left / right when projecting level. For details about how to move the image, refer to <a href="#">page 64</a> .

Press the **OK** button to accept your setting and then press the **MENU** button or **EXIT** button.

- [16:10] is the factory default.
- Changing the screen aspect will reset any keystone or digital image shift setting.
- [Auto] may be automatically selected for the aspect depending on the screen aspect setting.

## Adjusting the Size of Projected Images (WUX400ST/WX450ST)

MENU > [Install settings] > **[Zoom]**

- HDMI       Component       LAN  
 Digital PC       Analog PC       USB

Projected images that do not fit on the screen can be projected at a digitally reduced size.

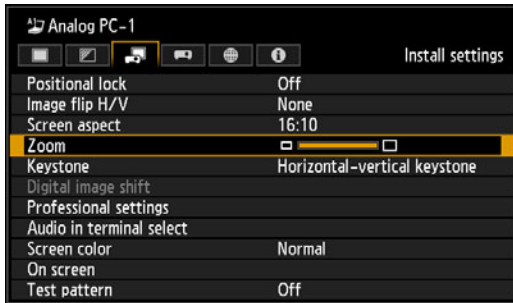

Press the [◀] button on the remote control to project images at a reduced size, and press the [▶] button to enlarge images to full size. Images can be projected at 75-100% of the original size.

- The factory default is 100%.

⚠ **D.ZOOM** buttons on the remote control cannot be used for this [Zoom] function.



- [Zoom] is not available when the following features are used.
  - Horizontal/vertical keystone correction (P68)
  - Split-screen mode (P81)
- Using [Zoom] after specifying corner adjustment (P69) will clear corner adjustment settings and apply the zoom setting. Instead, use [Zoom] before fine-tuning the image position with corner adjustment.
- If images still extend off the screen even after you use [Zoom], you can use corner adjustment (P69) to fine-tune the position of image corners, so that images fit on the screen.

## Specifying Keystone Correction

**MENU** > [Install settings] > [**Keystone**]

- HDMI       Component       LAN  
 Digital PC       Analog PC       USB

Two types of keystone correction are available: horizontal-vertical keystone and corner adjustment. Keystone correction can also be reset. Keystone correction can be applied by pressing the **KEYSTONE** button. (P68)

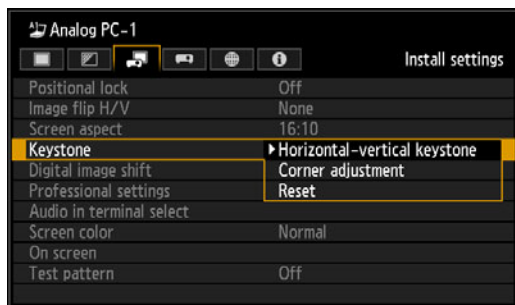

<b>Horizontal-vertical keystone</b>	In this case, horizontal-vertical keystone correction is applied.
<b>Corner adjustment</b>	Performs corner adjustment when the <b>KEYSTONE</b> button is pressed.
<b>Reset</b>	Resets the specified keystone value.

Pressing the **KEYSTONE** button when the screen aspect is [16:9 D. image shift] or [4:3 D. image shift] will not apply keystone correction.

## Specifying Digital Image Shift

**MENU** > [Install settings] > [**Digital image shift**]

- HDMI       Component       LAN  
 Digital PC       Analog PC       USB

Moves the position of the projected image.

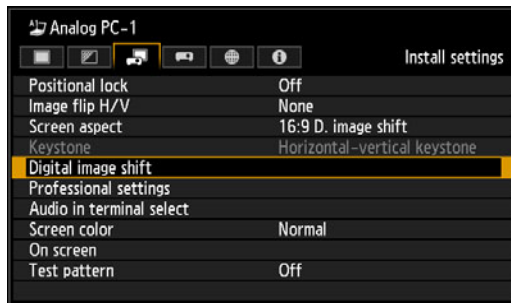

Press the **OK** button or [**▶**] button to display the D. image shift adjustment screen.

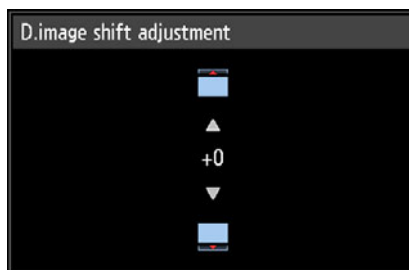

Correct using the [**▲**] / [**▼**] buttons (for 16:9 D. Image Shift) or [**◀**] / [**▶**] buttons (for 4:3 D. Image Shift).

When you have finished correcting, press the **OK** button.

- This cannot be selected when the screen aspect is 16:9, 16:10 or 4:3.
- Vertical image adjustment is available with a screen aspect of [16:9 D. image shift] and horizontal with [4:3 D. image shift].

## Specifying Micro Digital Image Shift

 > [Install settings] > [Professional settings] > **[Micro-digital image shift]**

- HDMI     Component     LAN  
 Digital PC     Analog PC     USB

Use this setting to fine-tune digital image shift.

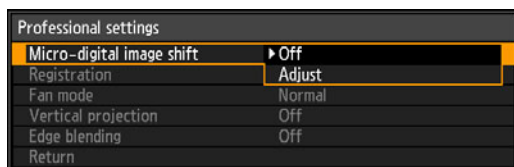

**Off** Does not perform micro digital image shift.

**Adjust** Performs micro digital image shift.

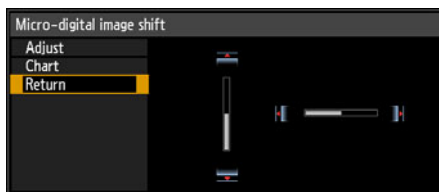

Use the [▲] / [▼] buttons for vertical shift.

Use the [◀] / [▶] buttons for horizontal shift. When you have finished correcting, press the **OK** button.

When you have completed the adjustment, press the **OK** button to accept your setting and then press the **MENU** button or **EXIT** button.

- [Off] is the factory default.
- Select [Adjust] to fine-tune the image position.

## Adjusting Image Registration

 > [Install settings] > [Professional settings] > **[Registration]**

- HDMI     Component     LAN  
 Digital PC     Analog PC     USB

Adjusts colors that are out of alignment. You can adjust red and blue registration independently, relative to green.



**Off** Does not perform image registration.

**Adjust** Performs image registration.

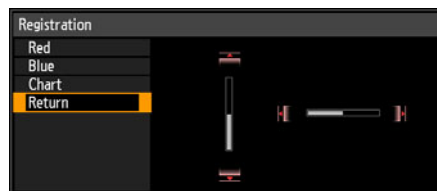

When the setting is completed, press the **OK** button.

When the setting is completed, press the **OK** button to accept your setting and then press the **MENU** button or **EXIT** button.

- [Off] is the factory default.
- You can adjust image registration by selecting [Red] or [Blue].

## Specifying the Fan Mode

 > [Install settings] > [Professional settings] > **[Fan mode]**

- HDMI     Component     LAN  
 Digital PC     Analog PC     USB

Enable suitable cooling by switching the fan mode to the setting for low- or high-altitude (above 2,300 m (7,545.8')) operation.



<b>Normal</b>	Setting for use in altitudes lower than 2,300 m (7,545.8').
<b>High altitude</b>	Setting for use in altitudes of 2,300 m (7,545.8') or higher.

When the setting is completed, press the **OK** button to accept your setting and then press the **MENU** button or **EXIT** button.

- [Normal] is the factory default.

 Incorrect settings may shorten the useful life of the lamp or other parts.

## Specifying Vertical Projection

 > [Install settings] > [Professional settings] > **[Vertical projection]**

- HDMI     Component     LAN  
 Digital PC     Analog PC     USB

You can ensure adequate cooling by switching the fan mode to suit upward- or downward-facing installations.

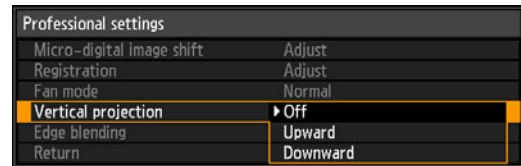

<b>Off</b>	Does not alter the fan mode.
<b>Upward</b>	Setting for use when the projector faces upward
<b>Downward</b>	Setting for use when the projector faces downward

When the setting is completed, press the **OK** button to accept your setting and then press the **MENU** button or **EXIT** button.

- [Off] is the factory default.

 Even if you complete this setting, vertical projection will result in a shorter useful life of the lamp and other parts than horizontal projection.



## Selecting the Audio In Terminal

**MENU** > [Install settings] > **[Audio in terminal select]**

- HDMI     Component     LAN  
 Digital PC     Analog PC     USB

You can select the audio in terminal that is used for each input signal (HDMI, Digital PC, Analog PC-1, Analog PC-2, Component).

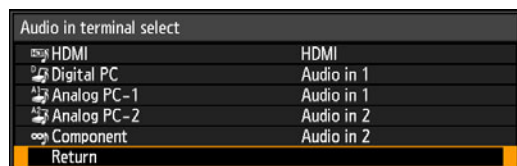

<b>Off</b>	No audio is output.
<b>Audio in 1</b>	Outputs the audio signal that is inputted in Audio in terminal 1.
<b>Audio in 2</b>	Outputs the audio signal that is inputted in Audio in terminal 2.
<b>HDMI</b>	Outputs the HDMI audio signal. (Only for HDMI)

Press the **OK** button to accept your setting and then press the **MENU** button or **EXIT** button.

- The factory default is as follows.  
 HDMI [HDMI]  
 Digital PC [Audio in 1]  
 Analog PC-1 [Audio in 1]  
 Analog PC-2 [Audio in 2]  
 Component [Audio in 2]

## Adjusting Colors to Suit the Screen Color

**MENU** > [Install settings] > **[Screen color]**

- HDMI     Component     LAN  
 Digital PC     Analog PC     USB

You can adjust the color quality of the images projected according to the color of the projection screen.

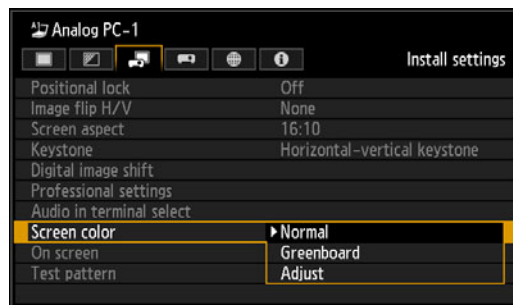

- Normal** Select this if a standard type of projection screen is used. The images are projected in a light quality similar to that of natural light.
- Greenboard** Select this if a greenboard (dark green color) is used for the projection screen. The color quality similar to [Normal] is obtained on the greenboard.
- Adjust** Select this to make detailed adjustment. The following popup screen will appear.

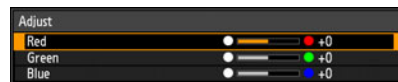

Press the [**▲**] / [**▼**] buttons to select a color.  
 [**▶**] makes the color selected darker.  
 [**◀**] makes the color selected lighter.

Press the **OK** button to accept your setting and then press the **MENU** button or **EXIT** button.

- [Normal] is the factory default.

## Specifying a Menu Position

 > [Install settings] > [On screen] > **[Menu position]**

- HDMI     Component     LAN  
 Digital PC     Analog PC     USB

You can change the position of menus displayed.



Use the [▲] / [◀] / [▼] / [▶] buttons to move the menu to the desired position.

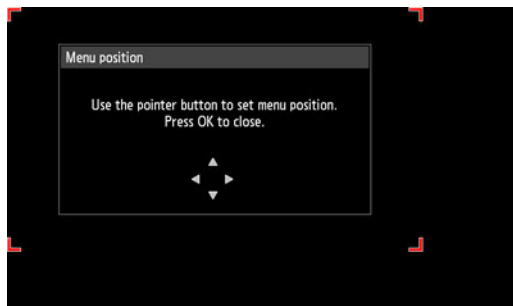

After you have moved the menu to the desired position, press the **OK** button to accept your setting, and then press the **MENU** or **EXIT** button.

## Showing/Hiding the Guide Screen

 > [Install settings] > [On screen] > **[Guide]**

- HDMI     Component     LAN  
 Digital PC     Analog PC     USB

You can select whether to show or hide the guide screen which explains operations.

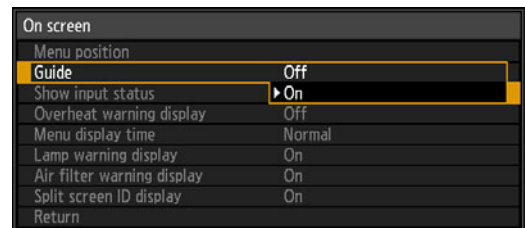

**Off** Hides the guide screen.

**On** Shows the guide screen.

Press the **OK** button to accept your setting and then press the **MENU** button or **EXIT** button.

- The factory default is [On].
- The guide screen is shown at the following times.
  - When no input signal can be detected. (P145)
  - When an invalid button is pressed in the [BLANK], [FREEZE] or [D.ZOOM] mode. (P76, P78)
  - When the positional lock is set to [On]. (P146)
  - When the projector is already on and the **POWER** button is pressed again.

## Showing/Hiding Input Status

 > [Install settings] > [On screen] > **[Show input status]**

- HDMI     Component     LAN  
 Digital PC     Analog PC     USB

You can select whether the signal status is displayed on the screen when there is no signal or when making signal settings.

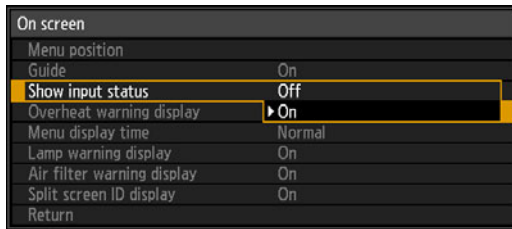

**Off** The input status is not displayed.

**On** The input status is displayed.

Press the **OK** button to accept your setting and then press the **MENU** button or **EXIT** button.

- The factory default is [On].

## Showing/Hiding Overheat Warnings

 > [Install settings] > [On screen] > **[Overheat warning display]**

- HDMI     Component     LAN  
 Digital PC     Analog PC     USB

You can select whether or not to display the [High temperature warning] icon when the temperature inside the projector has increased and is approaching the overheat temperature.

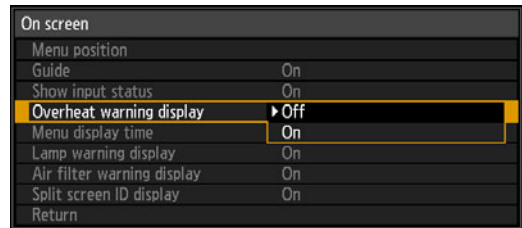

**Off** The [High temperature warning] icon is not displayed.

**On** The [High temperature warning] icon is displayed.

Press the **OK** button to accept your setting and then press the **MENU** button or **EXIT** button.

When [On] is set, the [High temperature warning] icon shown below will be displayed when the temperature inside the projector is abnormally high.

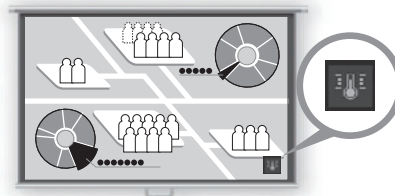

Screen

- [Off] is the factory default.

## Specifying the Menu Display Time

 > [Install settings] > [On screen] > [Menu display time]

- HDMI     Component     LAN  
 Digital PC     Analog PC     USB

The setting for the menu display time can be extended from the normal 10 or 30 seconds to 3 minutes.

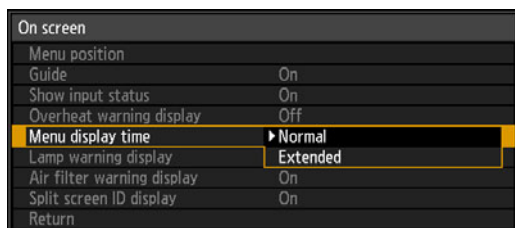

- Normal**    The menu is displayed for 10 or 30 seconds.
- Extended**    The menu is displayed for 3 minutes.

Press the **OK** button to accept your setting and then press the **MENU** button or **EXIT** button.

- [Normal] is the factory default.
- The following display and operation are also changed.

Item	[Normal]	[Extended]
The display time of the following screens -MENU screen	30 seconds	3 minutes
-Input (P54) -Keystone adjustment (P68) -Keystone reset (P70) -D.image shift adjustment (P63, P64) -D.image shift reset (P65) -Aspect (P67) -Image Mode (P71) -Volume adjustment (P77) -Gamma correction (P100)	10 seconds	3 minutes

## Showing/Hiding Lamp Replacement Warnings

 > [Install settings] > [On screen] > [Lamp warning display]

- HDMI     Component     LAN  
 Digital PC     Analog PC     USB

A message that advises you to change the lamp can be set to display when the lamp has been used for the specified period of time.



- On**    The prepare lamp message and the lamp warning are displayed.
- Off**    The prepare lamp message and the lamp warning are not displayed.  
**When it is time to replace the lamp, the LAMP indicator on the projector will flash, and lamp replacement (P202) is recommended at this time.**

Press the **OK** button to accept your setting and then press the **MENU** button or **EXIT** button.

- The factory default is [On].

## Showing/Hiding Filter Cleaning Warnings

 > [Install settings] > [On screen] > [Air filter warning display]

HDMI     Component     LAN  
 Digital PC     Analog PC     USB

A message advising you to perform cleaning can be set to display when the filter needs cleaning.

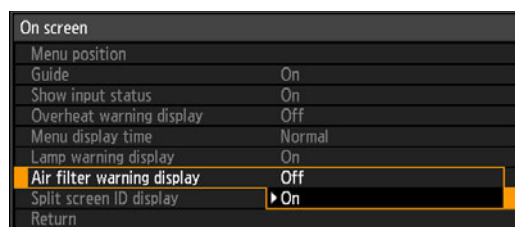

**Off** The air filter warning is not displayed.

**On** The air filter warning is displayed.

Press the **OK** button to accept your setting and then press the **MENU** button or **EXIT** button.

- The factory default is [On].

## Showing/Hiding Split-Screen ID

 > [Install settings] > [On screen] > [Split screen ID display]

HDMI     Component     LAN  
 Digital PC     Analog PC     USB

Specify whether to show or hide the digit (1 or 2) that identifies screens in split-screen mode. Note that even if you select [Off], a marker will be displayed in the corner of the screen to identify the screen that has control rights.



**Off** Hides the screen ID.

**On** Shows the screen ID.

When you have completed the adjustment, press the **OK** button to accept your setting and then press the **MENU** button or **EXIT** button.

- The factory default is [On].

# Showing/Hiding the Test Pattern

MENU

 > [Install settings] > [Test pattern]

- HDMI       Component       LAN  
 Digital PC       Analog PC       USB

You can project a test pattern ([P291](#)) to check resolution, color, and other details even without supplying an input signal.

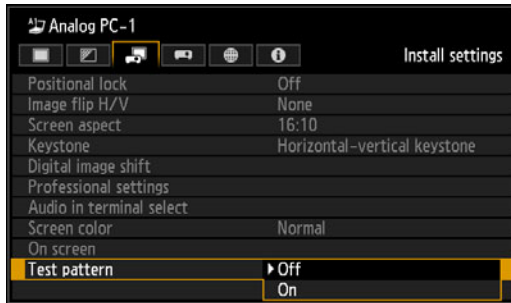

**Off** The test pattern is not displayed.

**On** Displays the test pattern.

Press the **OK** button to accept your setting and then press the **MENU** button or **EXIT** button.

- [Off] is the factory default.
- During test pattern display, you can use the **[▲]** / **[▼]** buttons to switch test patterns. Additionally, if a test pattern has option settings, you can change the settings using the **[◀]** / **[▶]** buttons. ([P291](#))
- The test pattern can also be displayed or turned off by pressing the **TEST PATTERN** button on the remote control.

# Projecting from Multiple Projectors at Once (Edge Blending)

 > [Install settings] > [Professional settings] > **[Edge blending]**

- HDMI     Component     LAN  
 Digital PC     Analog PC     USB

Overlapping edges of images from multiple projectors used together can be blended to make the overall image more seamless.

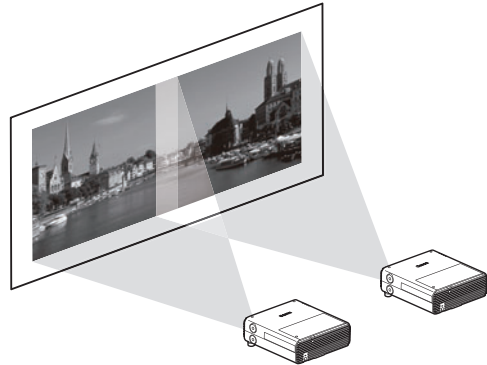

## ■ Basic Instructions

Follow these steps when using two projectors side by side.

- 1 In the [Install settings] menu, select [Professional settings] > [Edge blending].
- 2 Select [Adjust].

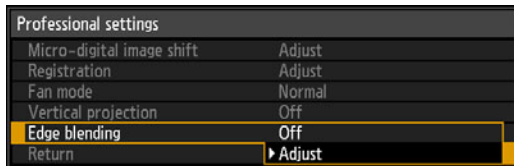

The edge blending window is displayed.

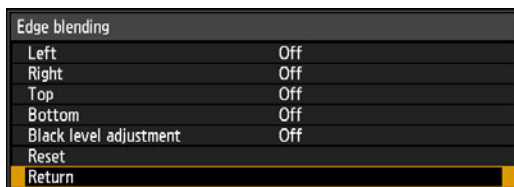

## Installation-Related Menu Settings

Here, you can use the following settings in the edge blending menu.

<b>Off</b>	Does not blend overlapping areas.
<b>Adjust</b>	Displays the menu for blending overlapping areas.
<b>Left, Right, Top, Bottom</b>	
Off	Projects an image with no correction.
Adjust Marker Off	Hides the markers.
On	Displays markers showing the adjustable blending area, with one line indicating the start position (in red) and another, the end position (in green).
Start position	Moves the marker for the start position.
Width	Specifies the width between the start and end markers.
Reset	Resets the marker settings.
<b>Black level adjustment</b>	Adjusts the black level of non-overlapping image areas. (P162)
<b>Reset</b>	Resets any adjustments you have made.



- If you have already completed edge blending settings, selecting [Adjust] will apply them.
- To restore the default settings before adjustment, select [Reset].

### 3 Select the position where the images overlap.

When you are adjusting the left image, this area is along the right edge of the image. In the edge blending window, select [Right] > [Adjust].

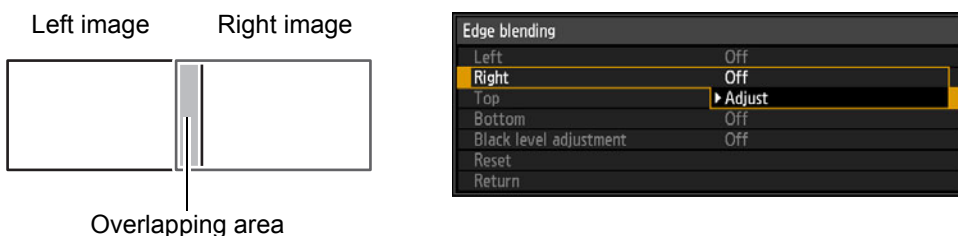

### 4 Set [Marker] to [On].

Marker lines are projected on the images. The red marker indicates the start position for adjustment, and the green marker, the end position.

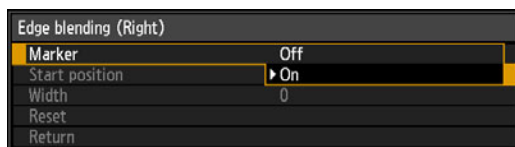

- By default, the green and red markers are displayed in the same position, so only the red marker is visible.



- 5 Select [Start position] and use the remote's [◀] [▶] buttons to move the markers to the right edge where the images overlap.
- 6 Select [Width], and use the remote's [◀] [▶] buttons to move the markers to the overlapping area.

The area between the starting and ending markers is called the blending area. Brightness of this area is automatically adjusted to match the brightness of other image areas. After you complete settings for the left image, do the same thing for the right image, to specify the blending area along the left edge. Adjust the area so that the blending area for the left and right images is the same.

⚠ Specifying a large blending area may cause dialog boxes for input signal selection or status to be covered by the blending area. In this case, momentarily switch edge blending from [Adjust] to [Off], check the display, and then return the setting to [Adjust].



Although the starting marker is normally aligned with the image edge, it can also be aligned more toward the center of the image. In this case, the black blending area will lie outside of the starting marker.

- 7 Set [Marker] to [Off].

## Edge Blending with Four Projectors

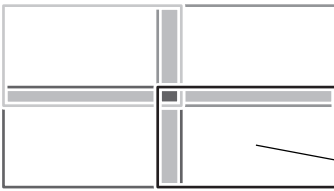

Images from four projectors can also be blended, as shown at left. Specify the blending area where each image overlaps with others.

Example: When specifying the blending area for the lower-right image, configure the settings for blending areas along the top and left image edges. Complete the settings for the other three images the same way for the edges that overlap.

### ■ Advanced Instructions: Black Level Adjustment

In overlapping projection, dark colors are projected with less intensity than other colors in the overlapping area. For this reason, overlapping image areas might be more noticeable when the images themselves are dark. You can make this overlapping area less distracting by adjusting the black level of non-overlapping image areas.

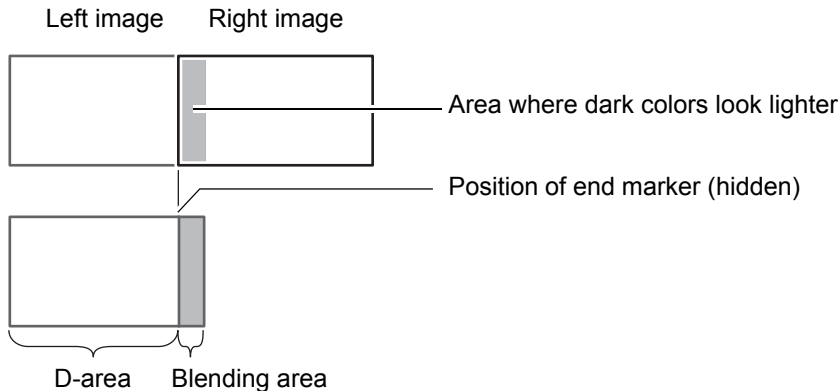

Here, the non-overlapping image area (from the end marker toward the center of the image) is called area “D.”

Normally, three areas are identified in the context of end markers: A, B, and C. In the following instructions, only area D is adjusted, and the widths of A, B, and C are left at the default value of 0.



- To prepare for adjustment, set [No signal screen] to [Black], start projection with no input signal, and turn off the room lights, so that you can check dark image areas. (P109)
- Set [Marker] to [Off].

**1** On the edge blending screen of step 2 in “Basic Instructions” (P159), select [Black level adjustment] > [Adjust].

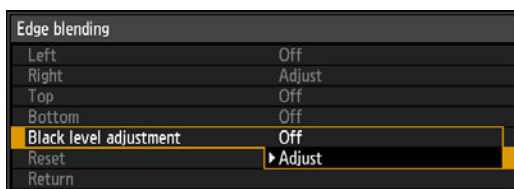

The black level adjustment window is projected.

Here, you can use the following settings in the edge blending menu.

Black level adjustment	Adjust the black level of non-overlapping image areas.	
	Off	
	Adjust	
	Adjustment type	Black level
	D-area base	Adjust the area D black level.
	D-area red	Adjust the red component of the area D black level.
	D-area green	Adjust the green component of the area D black level.
	D-area blue	Adjust the blue component of the area D black level.

**2 Select [Adjustment type] > [Black level].**

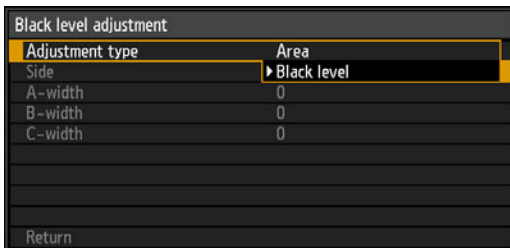

**3 Select [D-area base], and use the remote's [◀] [▶] buttons to adjust the values for area D.**

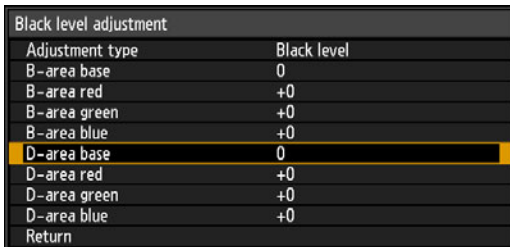

As you watch the image, adjust the values so that the brightness and colors of the blending area and area D match. Adjust [D-area base] to lighten the black level, and adjust [Red], [Green], and [Blue] to obtain an optimal black level color tone, as needed.

**4 Repeat this adjustment on all projectors.**

## ■ Advanced Instructions: Smoother Overlapping Areas

Adjustments to areas A, B, and C may make the black level along the right edge of area D (that is, the edge bordering the blending area) more noticeable than that of surrounding areas.

To compensate, adjust each area as follows.

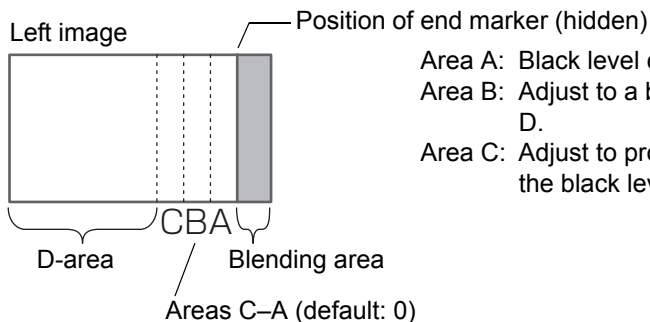

- Area A: Black level cannot be adjusted.
- Area B: Adjust to a black level different from that of area D.
- Area C: Adjust to provide a smooth transition relative to the black levels of areas B and D.

Black level adjustment	Adjust the black level of non-overlapping image areas.	
	Off	
	Adjust	
	Adjustment type	Area
	Side	On the image for adjustment, select the edge to adjust (left/right/top/bottom).
	A-Width	Adjusts the width of area A
	B-Width	Adjusts the width of area B
	C-Width	Adjusts the width of area C

When there are multiple blending areas relative to the projected image (on all edges), you must adjust the width of areas A, B, and C.

In this example, instructions are given for adjusting area B.

- 1 In the window of step 2 in “Advanced Instructions: Black Level Adjustment” (P162), select [Adjustment type] > [Area] > [Side] > [Right].



## 2 Select [B-width], and use the remote's [◀] [▶] buttons to specify the width of area B.

This will make the width of area D narrower.

Black level adjustment	
Adjustment type	Area
Side	Right
A-width	0
<b>B-width</b>	<b>0</b>
C-width	0
Return	

## 3 Adjust the width of area B to roughly match the area where the black level is noticeable, and then use the following edge-blending settings to adjust the black level of area B.

Adjust the black level of area B the same way as you adjusted it for area D.

Black level	
B-area base	Adjust the area B black level.
B-area red	Adjust the red component of the area B black level.
B-area green	Adjust the green component of the area B black level.
B-area blue	Adjust the blue component of the area B black level.

For adjustment instructions, see “Advanced Instructions: Black Level Adjustment” (P162), step 3.



Results of adjusting the black level of area B are applied to all sides.

## 4 Fine-tune the position and width of area B.

## 5 As you watch the image, adjust the width of areas A, B, and C.

## 6 Readjust the black level of area B, as needed.

## 7 When you have completed the adjustment, press the MENU or EXIT button.

- [Off] is the factory default.



However, adjusting [Contrast], [Screen color], or other settings may not eliminate distractions in image boundaries.



- To simplify adjustment, use the same lens shift position and image mode (ideally, [sRGB]) on each projector.
- For best edge-blending results, perform the following adjustments.
  - (1) Black and white adjustment by adjusting R/G/B gain and offset (P101)
  - (2) Gamma adjustment by fine-tuning gamma (P105)
  - (3) Color adjustment by using 6-axis color adjustment (P104)
- To reduce distracting colors or differences in brightness where images overlap, try darkening images by adjusting [Contrast] (or other [Image adjustment] menu settings) or [Screen color].



# Connecting to a Network

Table of Contents

Safety Instructions

Before Use

## Operation

Projecting an Image

Useful Functions Available During a Presentation

Setting Functions from Menus

## Installation and Maintenance

Installation

**Connecting to a Network**

Maintenance

## Networked Multi-Projection

Networked Multi-Projection Overview

Operation in Each Mode

Functions in All Modes

## Appendix

Other Information

Index

# Network Connection Overview

Connecting the projector to a network enables you to control the projector from a computer and receive notification of projector errors via email. Settings related to the network connection can be made from either the projector side (P169) or computer side. (P178)

Depending on the method of network connection, preparation on the computer side may be necessary. The following is an explanation of preparation on the computer side.



For details on networked multi-projection – projecting images from computers through one or more projectors over a network – see “Networked Multi-Projection.”

## Connection Methods

Connect the projector to the computer via LAN.

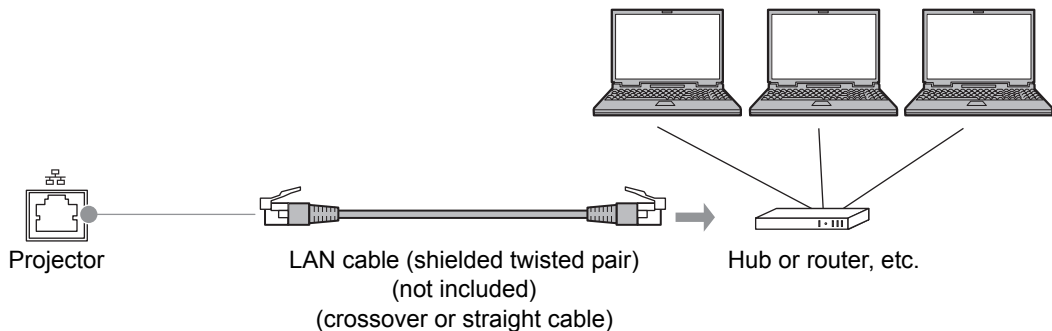

- When the [Network function] setting of the projector is set to [Off] (Network Connections is disabled), switch it to [On] to enable it. (P171)
- Referring to “Checking Projector Information” (P122), check that the projector IP address does not overlap with other computers that are on the same LAN. To set a projector IP address, follow the instructions in “Completing Computer Settings” (P178) and use the web screen, or use projector TCP/IP settings. (P174)
- When you connect the computer to the network for the first time, it is also necessary to perform settings on the computer. In this case, consult the network administrator regarding the necessary settings.



In a network environment where a DHCP server is operating, choose [On] on the projector [DHCP] screen to enable the DHCP function and connect it. (P174)



# Completing Projector Settings

From the projector menu screen, network settings can be configured in the [Network Setting] tab. For instructions on menu operations, refer to “Using Menus”. (P84)

## Locking/Unlocking Network Settings

**MENU** > [Network Settings] > [Network settings lock]

You can lock/unlock the network settings so that they cannot be changed.

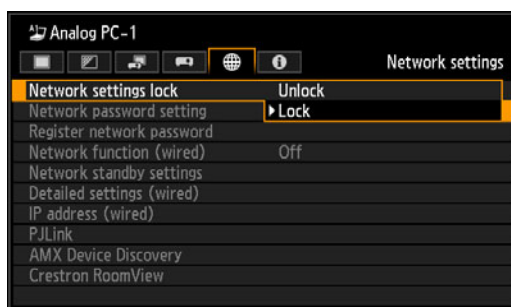

**Unlock** Cancels the lock and allows other network settings to be changed. The password must be entered in order to cancel the lock. Selecting [Unlock] will display the following window. Use the [▲] / [▼] / [◀] / [▶] buttons to enter the 4-digit password.



**Lock** Lock the settings.

Press the **OK** button to accept your setting, and then press the **MENU** button or **EXIT** button to close the window. The settings are now locked again. If you change the network settings, be sure to continue operating without closing the window.

- [Lock] is the factory default.
- The factory default network password is [▲] [▲] [▲] [▲].

### Forcibly canceling the network lock

On the Network password input screen, press the buttons in the following order to unlock the settings: [▲] [OK] [▶] [OK] [▼] [OK]. This will reset the network password to [▲] [▲] [▲] [▲].

## Enabling/Disabling the Network Password

 > [Network settings] > [Network password setting]

You can set whether or not a password is required in order to change the projector network settings.

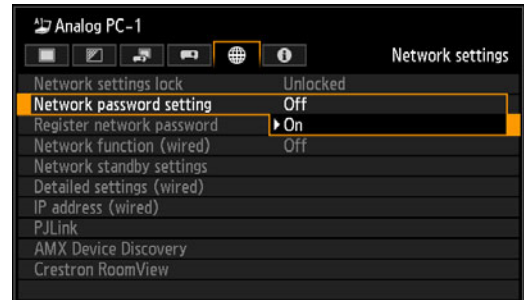

---

**Off** A network password is not used.

---

**On** A network password is used.

---

Press the **OK** button to accept your setting and then press the **MENU** button or **EXIT** button.

- The factory default is [On].

## Registering a Network Password

**MENU** > [Network settings] > [Register network password]

Register the projector network password.

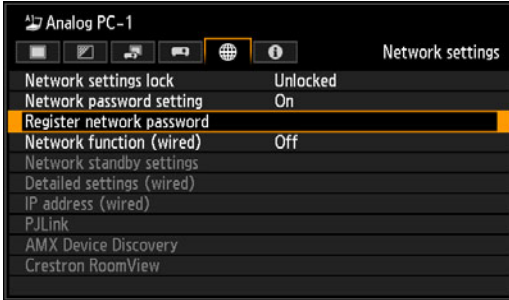

When [Register network password] is selected, the window shown below appears.

Enter a 4-digit password.

Enter the password using the [▼] / [▲] / [◀] / [▶] buttons on the remote control.



Press the **OK** button to accept your setting and then press the **MENU** button or **EXIT** button.

- If you forget the password, press [▲] [OK] [▶] [OK] [▼] [OK] to restore the factory default setting.

## Enabling/Disabling Wired Network Functions

**MENU** > [Network settings] > [Network function (wired)]

You can turn the projector network function on or off. Power can be saved by turning the function [Off].

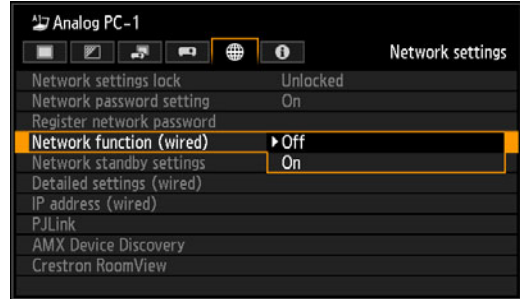

**Off** Disables the network function.

**On** Enables the network function.

Press the **OK** button to accept your setting and then press the **MENU** button or **EXIT** button.

- [Off] is the factory default.

# Specifying Standby Power Consumption

 > [Network settings] > **[Network standby settings]**

Specify network function operating status in standby mode as follows.

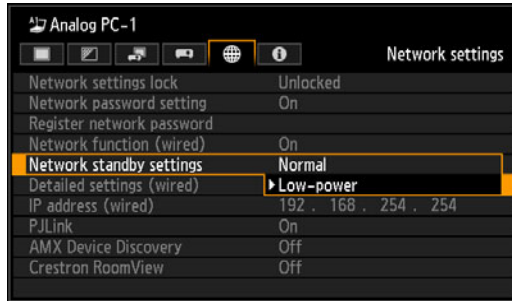

**Normal** All network functions are available even in standby mode, including the web screen, control over the network, and PJLink.

**Low-power** All network functions are available even in standby mode. However, the projector may be less responsive than usual when some functions are initially used.

Press the **OK** button to accept your setting and then press the **MENU** button or **EXIT** button.

- [Low-power] is the factory default.
- [Low-power] may delay access over the network for some functions. For faster access, select [Normal].
- Power consumption when [Network function (wired)] is [On] varies depending on whether [Network standby settings] is set to [Normal] or [Low-power].

# Viewing the IP Address

 > [Network settings] > [Detailed settings (wired)] > **[IP address]**

View the projector's IP address as follows.

Note that the information can only be displayed, not changed.

To change the settings, access the DHCP or TCP/IP settings.

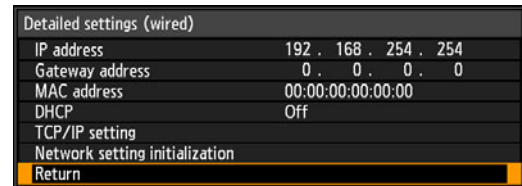

## Viewing the Gateway Address

 > [Network settings] > [Detailed settings (wired)] > **[Gateway address]**

View the projector's gateway address as follows.

**Note that the information can only be displayed, not changed.**

Detailed settings (wired)	
IP address	192 . 168 . 254 . 254
Gateway address	0 . 0 . 0 . 0
MAC address	00:00:00:00:00:00
DHCP	Off
TCP/IP setting	
Network setting initialization	
Return	

## Viewing the MAC Address

 > [Network settings] > [Detailed settings (wired)] > **[MAC address]**

View the projector's MAC address as follows.

**Note that the information can only be displayed, not changed.**

Detailed settings (wired)	
IP address	192 . 168 . 254 . 254
Gateway address	0 . 0 . 0 . 0
MAC address	00:00:00:00:00:00
DHCP	Off
TCP/IP setting	
Network setting initialization	
Return	

## Enabling/Disabling DHCP

**MENU** > [Network settings] > [Detailed settings (wired)] > **[DHCP]**

You can turn the projector DHCP function on or off.

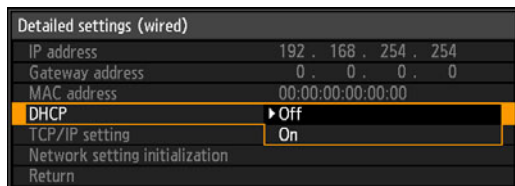

**Off** Disables the DHCP function. TCP/IP settings are possible.

**On** Enables the DHCP function. Searches the DHCP server. Because the IP address is acquired from the DHCP server, it is not necessary to enter the TCP/IP settings (IP address, subnet mask, gateway address).

Press the **OK** button to accept your setting and then press the **MENU** button or **EXIT** button.

- [Off] is the factory default.

## Specifying TCP/IP Settings

**MENU** > [Network settings] > [Detailed settings (wired)] > **[TCP/IP setting]**

Configure the projector TCP/IP settings.

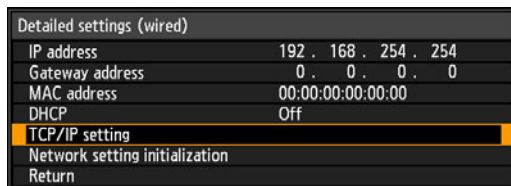

When [TCP/IP setting] is selected, the window shown below appears. Use the [**▲**] / [**▼**] buttons to select the IP address, then press the **OK** button. Next, use the [**◀**] / [**▶**] buttons to select the digit and the [**▲**] / [**▼**] buttons to change the value.

Press the **OK** button, then set the subnet mask and gateway address in the same way. Finally, select [Enter].

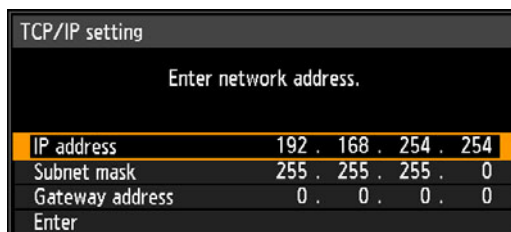

- The factory default settings are as follows.  
 IP address: 192.168.254.254  
 Subnet mask: 255.255.255.0  
 Gateway address: 0.0.0.0
- Settings cannot be made when [DHCP] (P174) is [On].
- If an invalid value is entered, the message "Invalid entry" appears. If this occurs, enter a valid value.

## Initializing Network Settings

 > [Network settings] > [Detailed settings (wired)] > [**Network setting initialization**]

You can initialize the projector network settings.

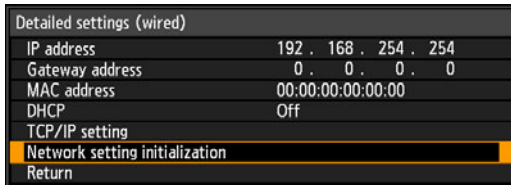

When [Network setting initialization] is selected, the window shown below appears. Select [Yes] then press the **OK** button.

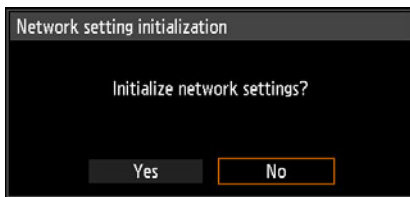

- The following items are initialized.
  - Settings used for web login, such as the network setting screen, user name, password, and other settings
  - Network password setting
  - Network function (wired)
  - Network standby settings
  - Register network password
  - PJLink
  - DHCP
  - IP address
  - Subnet mask
  - Gateway address
  - E-mail sender address
  - E-mail recipient address
  - Projector name
  - Location
  - AMX Device Discovery settings
  - Crestron RoomView settings

## Specifying PJLink Settings

 > [Network settings] > [**PJLink**]

You can turn the PJLink network function on or off. When the function is turned on, control is possible via the LAN using commands that meet PJLink standards.

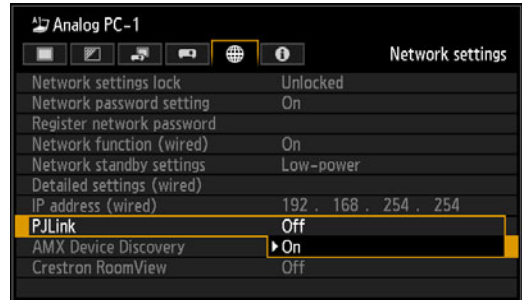

**Off** Disables the PJLink function.

**On** Enables the PJLink function.

Press the **OK** button to accept your setting and then press the **MENU** button or **EXIT** button.

- [On] is the factory default.
- This projector conforms to Class 1 as defined in the PJLink standards of the JBMIA (Japan Business Machine and Information System Industries Association). This projector supports all commands that are defined by PJLink Class 1, and has been verified as conforming to the PJLink standard Class 1 definition.
- For information about using PJLink, refer to "Setting PJLink [PJLink]" (P191).

### What is PJLink?

In September 2003, the PJLink Working Group was established under the Data Projector Committee. During the first year, this PJLink Working Group standardized PJLink as a new interface specification for projectors.

PJLink is a unified standard for operation and control of projectors. It allows centralized control of projectors and operation from a controller for all projectors regardless of manufacturer.

The objective is for JBMIA to improve convenience for users and expand the use of projectors through early systemization for network monitoring and control of projectors, which will become the mainstream in the future.

**Class 1: Standardization of control and monitoring specifications for basic projector functions**

**Basic projector control:** Power control, input selection, etc.

**Acquisition of projector information and status:** Power status, input selection status, error status, lamp use time, etc.

**JBMIA:** Japan Business Machine and Information System Industries Association. The JBMIA is an organization which was launched in 1960 and changed its name on April 1, 2002.

**PJLink website:**  
<http://pjlink.jbmia.or.jp/english/>



PJLink is a registered trademark of JBMIA and pending trademark in some countries.

## Specifying Use of AMX Device Discovery

 > [Network settings] > [AMX Device Discovery]

**In a network environment, AMX Device Discovery can be used to enable other equipment to discover the projector. For networks without AMX Device Discovery, select [Off].**

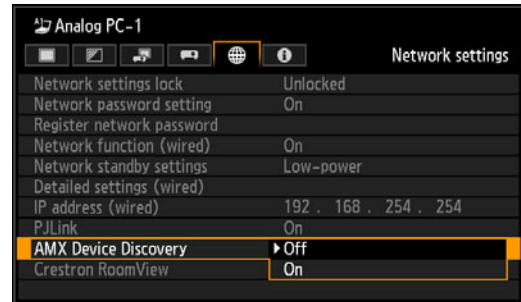

**Off** Disables AMX Device Discovery.

**On** Enables AMX Device Discovery. The projector will periodically send out AMX beacon packets over the network.

- [Off] is the factory default.

 For details on AMX Device Discovery, visit the AMX website.  
<http://www.amx.com/>



## Specifying Use of Crestron RoomView

 > [Network settings] > [Crestron RoomView]

Crestron RoomView enables centralized management of multiple projectors over a network. For example, projectors can be remotely controlled to troubleshoot issues, check the useful life of lamps, or turn the projectors on or off. Specify whether or not to use Crestron RoomView as follows.

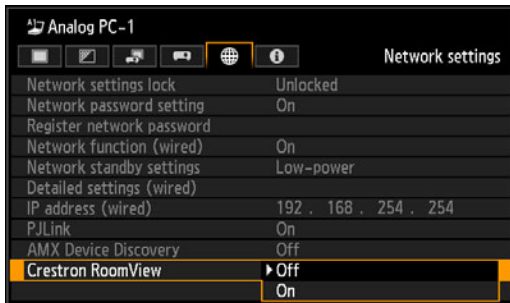

**Off** Disables Crestron RoomView.

**On** Enables Crestron RoomView. A port for RoomView will be opened, and the projector will respond to CIP packets. This enables communication via the RoomView Express/Server application or via Crestron Controller. (P191)

- [Off] is the factory default.



For details on Crestron RoomView, visit the Crestron® website.  
<http://www.crestron.com/>

# Completing Computer Settings

## Specifying an IP Address

Following is an explanation of how to set the PC IP address for each operating system.

### ■ Windows 7

- 1 From the PC [Start] menu, select [Control Panel].
- 2 Click on [Network and Internet], then click on [View network status and tasks].
- 3 From the menu on the left side of the window, click on [Change adapter settings].
- 4 Right-click [Local Area Connection], and open [Properties].
- 5 Select [Internet Protocol Version 4 (TCP/IPv4)] and click the [Properties] button. Make a note of the original network settings (IP address, subnet mask, default gateway, etc).
- 6 Select [Use the following IP address] and set the IP address and subnet mask.

The factory default IP address for the projector is “192.168.254.254”. Set an IP address which is different from this.

Example

IP address: 192.168.254.1

Subnet mask: 255.255.255.0

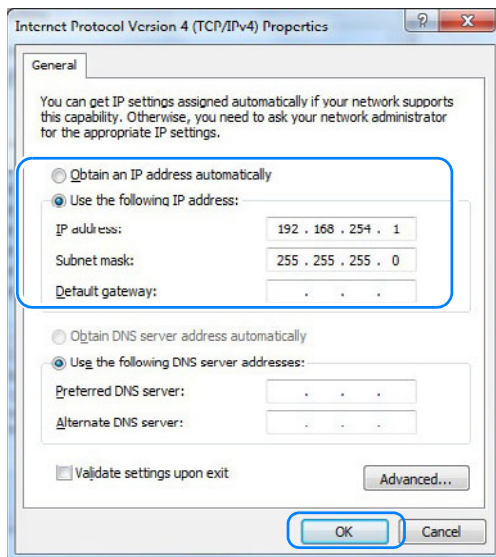

- 7 When the settings are completed, click the [OK] button and then click the [OK] button on the [Local Area Connection Properties] window to close it.

## ■ Windows Vista

- 1 From the PC [Start] menu, select [Control Panel].
- 2 Click on [View network status and tasks].
- 3 From the menu on the left side of the window, click on [Manage network connections].
- 4 Right-click [Local Area Connection], and open [Properties].
- 5 Select [Internet Protocol Version 4 (TCP/IPv4)] and click the [Properties] button. Make a note of the original network settings (IP address, subnet mask, default gateway, etc).
- 6 Select [Use the following IP address] and set the IP address and subnet mask.

The factory default IP address for the projector is “192.168.254.254”. Set an IP address which is different from this.

Example

IP address: 192.168.254.1

Subnet mask: 255.255.255.0

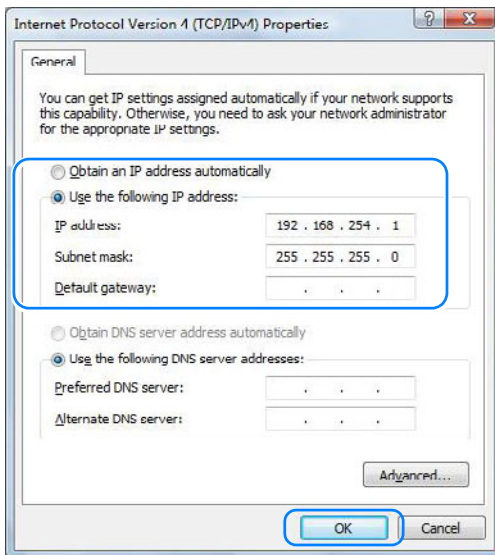

- 7 When the settings are completed, click the [OK] button and then click the [OK] button on the [Local Area Connection Properties] window to close it.

### ■ Windows XP

- 1 From the PC [Start] menu, select [Control Panel].
- 2 Select [Network and Internet Connections] and open [Network Connections].
- 3 Right-click [Local Area Connection], and open [Properties].
- 4 Select [Internet Protocol (TCP/IP)] and click the [Properties] button. Make a note of the original network settings (IP address, subnet mask, default gateway, etc.).
- 5 Select [Use the following IP address] and set the IP address and subnet mask.

The factory default IP address for the projector is “192.168.254.254”. Set an IP address which is different from this.

Example

IP address: 192.168.254.1

Subnet mask: 255.255.255.0

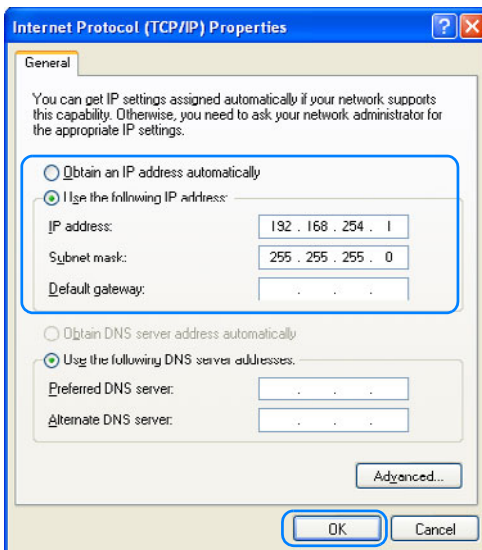

- 6 When the settings are completed, click the [OK] button and then click the [OK] button on the [Local Area Connection Properties] window to close it.

### ■ Mac OS X

- 1 Open the Apple Menu and select [System Preferences].
- 2 In the System Preferences window, click [Network] to display the Network window.
- 3 Select [Built-in Ethernet] and click the [TCP/IP] tab. Make a note of the original network settings (IP address, subnet mask, router, DNS server, etc.).

**4 Create a new network environment and set the IP address and subnet mask.**

The factory default IP address for the projector is “192.168.254.254”. Set an IP address which is different from this.

Example

IP address: 192.168.254.1

Subnet mask: 255.255.255.0

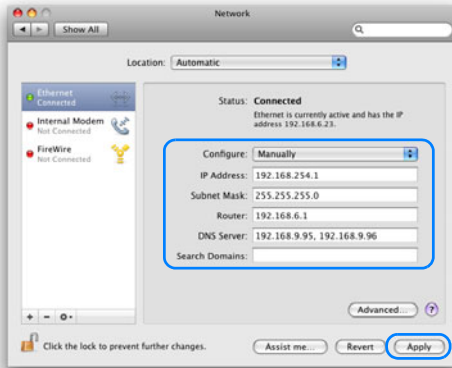

**5 Click [Apply] to close the network preference window.**

**■ Resetting the IP Address Setting of the Computer**

Follow the same procedure as for changing the IP address and reset the values to the original values based on the notes taken before the change.

## Setting Up the Network

**■ Displaying the Network Configuration Screen**

**1 Turn on the computer and projector.**

 Network functions are not available for the first 40 seconds after projector startup.

**2 Launch a web browser, enter “http://(projector IP address)” in the address bar, and press the Enter key.**

The projector web screen appears.

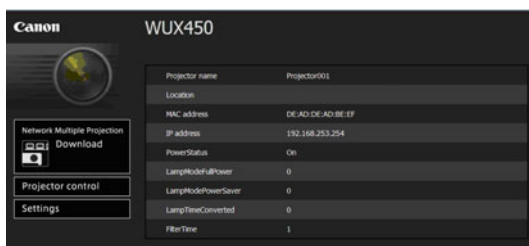

## Completing Computer Settings

The following information is displayed.

Network Multiple Projection Download	For downloading the Networked Multi-Projection (NMPJ) program. (P211)
Projector control	Displays the projector control screen.
Settings	Shows the settings screen.
Projector name	The name of the projector on the network
Location	The location of projector installation
MAC address	The MAC address of the projector
IP address	The IP address of the projector
PowerStatus	The power status of the projector
LampModeFullPower	Lamp operating time in [Full power] lamp mode
LampModePowerSaver	Lamp operating time in [Power saver] lamp mode
LampTimeConverted	Lamp operating time (converted value)
FilterTime	Air filter operating time
Alert	Error message (if an error has occurred) Temperature abnormality Faulty lamp Faulty cooling fan Faulty air filter unit Faulty power supply



The factory default IP address is “192.168.254.254”. If DHCP settings are used, ask the network administrator for the projector IP address. It is possible to check the IP address from the projector menu.

### 3 Click [Settings] on the web screen.

The password input window appears.

### 4 Enter the user name and password on the password input window, then click [OK].

The factory default user name is “root” and the password is “system”.



The projector settings screen is displayed in the web browser.

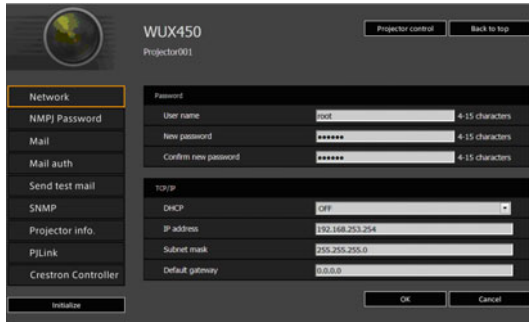

To operate the projector from the computer, click [Projector control] (P195).

## ■ Network Setting

- 1 To access the settings screen, click [Settings] on the web screen in step 3 of “Displaying the Network Configuration Screen” (P181).



- 2 Select the function to set from the menu (1), then enter the setting in the displayed field (2) and click [OK] (3).

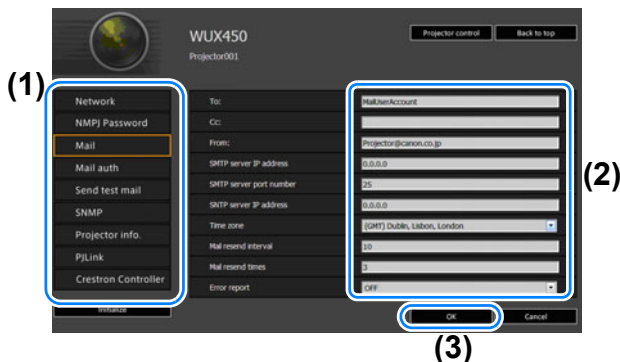

## Completing Computer Settings

- 3** A confirmation window appears. Check the contents and if they are correct, click [Apply].

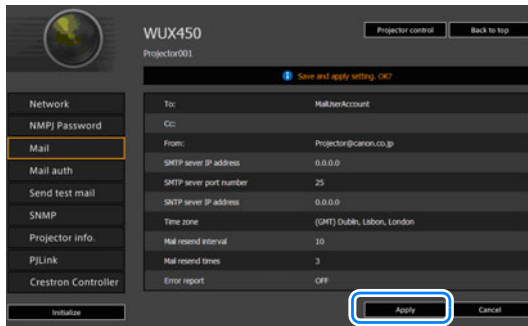

The settings are applied to the projector. When you select [Network] in the menu, this message is displayed: “Save completed. Please change setting and reconnect.”

If you select functions other than [Network], “Save completed” is displayed. Click [Back to top] to return to the top page of the web screen.

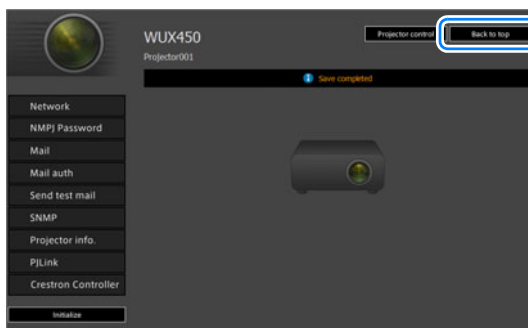

## Setting Basic Information [Network]

From [Network] in the settings screen, you can log into the web screen and set basic network information. For the setting procedure, refer to “Displaying the Network Configuration Screen” (P181).





Item	Explanation	Factory default setting
<b>Password</b>		
User name	When logging into the web screen, enter the user name in 1-byte alphanumeric characters and symbols (4 - 15 characters).	root
New password	When logging into the web screen, enter the password in 1-byte alphanumeric characters and symbols (4 - 15 characters).	system
Confirm new password	For confirmation, enter the same password that you entered in [New password].	system
<b>TCP/IP</b>		
DHCP	Select whether to turn the DHCP function on or off. If the function is on, because the IP address is acquired from the server, it is not possible to enter the [IP address], [Subnet mask], and [Default gateway].	OFF
IP address	Enter the IP address of the projector in 1-byte numbers.	192.168.254.254
Subnet mask	Enter the subnet mask in 1-byte numbers.	255.255.255.0
Default gateway	Enter the default gateway IP address in 1-byte numbers.	0.0.0.0



If settings related to TCP/IP were changed, it is necessary to disconnect and reconnect to the network.  
 If the network subnet mask was changed, select [Subnet mask] in the above screen and set the new subnet mask.

## Completing Computer Settings

### Specifying Networked Multi-Projection Settings: [NMPJ Password]

From [NMPJ Password] in the settings screen, you can specify the items needed for NMPJ authentication. For the setting procedure, refer to “Displaying the Network Configuration Screen” (P181).

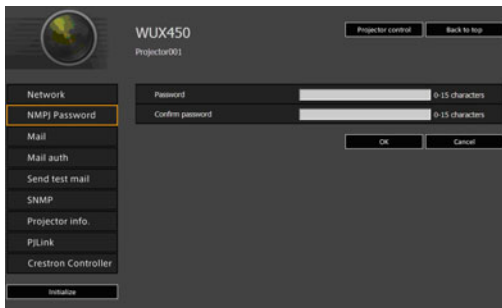

Item	Explanation	Factory default setting
Password	Enter the password for networked multi-projection authentication in single-byte alphanumeric characters (0-15 characters).	<Blank>
Confirm password	For confirmation, enter the same password as you entered in [Password].	<Blank>

### Setting Up Email [Mail]

From [Mail] in the settings screen, you can set the items necessary to send error mails and test mails. For the setting procedure, refer to “Displaying the Network Configuration Screen” (P181).

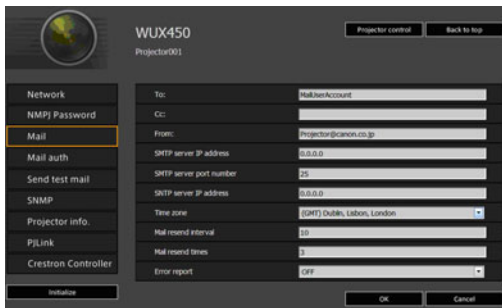

Item	Explanation	Factory default setting
To:	Enter the recipient address for error mails in 1-byte alphanumeric characters and symbols (1 - 63 characters).	MailUserAccount
Cc:	Enter the CC address for error mails in 1-byte alphanumeric characters and symbols (1 - 63 characters).	<Blank>
From:	Enter the sender address for error mails in 1-byte alphanumeric characters and symbols (1 - 63 characters).	Projector@canon.co.jp
SMTP server IP address	Enter the SMTP server IP address in 1-byte numbers.	0.0.0.0
SMTP server port number	Enter the SMTP server port number in 1-byte numbers (1 - 65535).	25
SNTP server IP address	Enter the SNTP server IP address in 1-byte numbers.	0.0.0.0
Time zone	Select the time zone where the projector is used.	(GMT) Dublin, Lisbon, London
Mail resend interval	Enter the interval for resending mail when an error occurred (units: seconds) within the range of 0 - 59 seconds using 1-byte numbers.	10
Mail resend times	Enter the number of times to resend mail when an error occurred within the range of 0 - 255 using 1-byte numbers.	3
Error report	Select whether to turn the error mail sending function on or off.	OFF

## Completing Computer Settings

### Mail Authentication Settings [Mail auth]

From [Mail auth] in the settings screen, you can configure the settings for authentication of mail that is sent when an error occurs. For the setting procedure, refer to “Displaying the Network Configuration Screen” (P181).

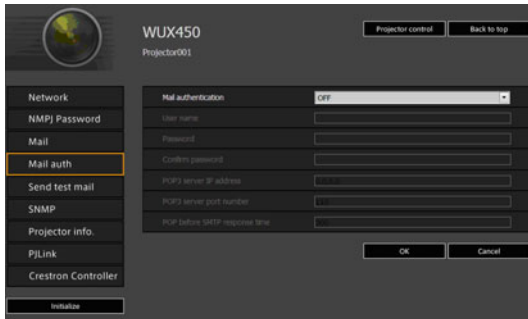

Item	Explanation	Factory default setting
Mail authentication	Select the mail authentication method. If OFF is selected, the other mail authentication settings cannot be changed.	OFF
User name	Enter the user name to use for mail authentication in 1-byte alphanumeric characters and symbols (1 - 63 characters).	<Blank>
Password	Enter the password for mail authentication in 1-byte alphanumeric characters and symbols (1 - 63 characters).	<Blank>
Confirm password	For confirmation, enter the same password as you entered in [Password].	<Blank>
POP3 server IP address	Enter the POP3 server IP address in 1-byte numbers.	0.0.0.0
POP3 server port number	Enter the POP3 server port number in 1-byte numbers (1 - 65535).	110
POP before SMTP response time	Enter the SMTP authentication timeout period after POP3 authentication (units: milliseconds) using 1-byte numbers (0 - 9999 milliseconds).	300

## Sending a Test Mail [Send test mail]

From [Send test mail] in the settings screen, you can send a test mail to the mail address that was set in [Mail]. The settings cannot be changed from this screen.

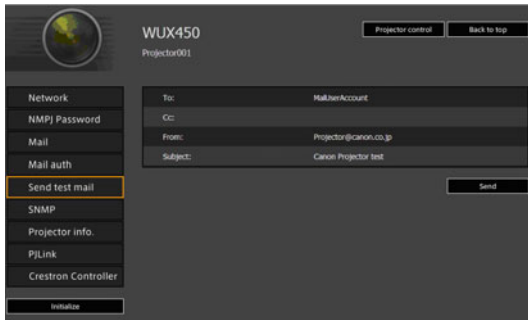

Item	Explanation
To:	The recipient address which was set from [Mail] in the settings screen (P186) is displayed.
Cc:	The CC address which was set from [Mail] in the settings screen (P186) is displayed.
From:	The sender address which was set from [Mail] in the settings screen (P186) is displayed.
Subject:	The predetermined mail title “Canon Projector test” is displayed.

## SNMP Settings [SNMP]

From [SNMP] in the settings screen, you can configure the settings related to control of projectors which use SNMP (Simple Network Management Protocol). For the setting procedure, refer to “Displaying the Network Configuration Screen” (P181).

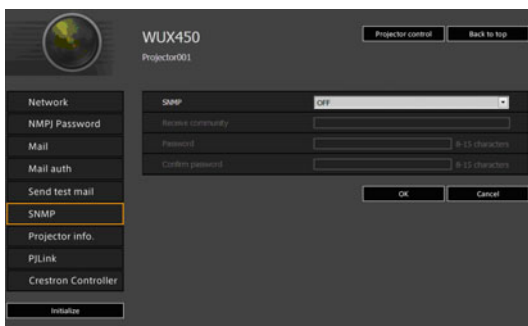

## Completing Computer Settings

Item	Explanation	Factory default setting
SNMP	Select the SNMP function version. If OFF is selected, the SNMP function will be turned off and the other settings in this screen cannot be changed.	OFF
Receive community	Enter the community name which will receive projector information in 1-byte alphanumeric characters and symbols (1 - 15 characters).	<Blank>
Password	Enter the community settings password in 1-byte alphanumeric characters and symbols (8 - 15 characters). It can be set only when the SNMP version is V3.	<Blank>
Confirm password	For confirmation, enter the same password as you entered in [Password].	<Blank>

### Setting Projector Information [Projector info.]

From [Projector info.] in the settings screen, you can set the names and location names which are used to identify projectors when multiple projectors are installed on the network. For the setting procedure, refer to “Displaying the Network Configuration Screen” (P181).

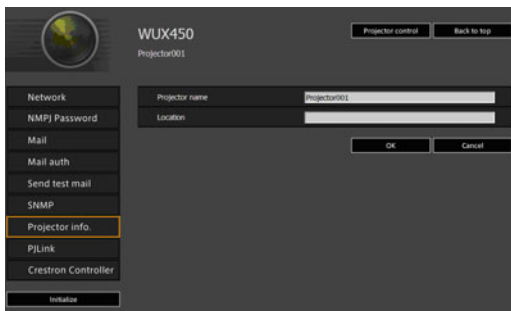

Item	Explanation	Factory default setting
Projector name	Enter the projector name in 1-byte alphanumeric characters and symbols (1 - 63 characters).	Canon Projector001
Location	Enter the projector installation location in 1-byte alphanumeric characters and symbols (0 - 63 characters).	<Blank>



Some characters such as # cannot be used for [Projector name] and [Location].

### Setting PJLink [PJLink]

From [PJLink] in the settings screen, you can set the PJLink functions which are the standard for projector management on a network. For the setting procedure, refer to “Displaying the Network Configuration Screen” (P181). For information about PJLink, refer to “What is PJLink?” (P176).

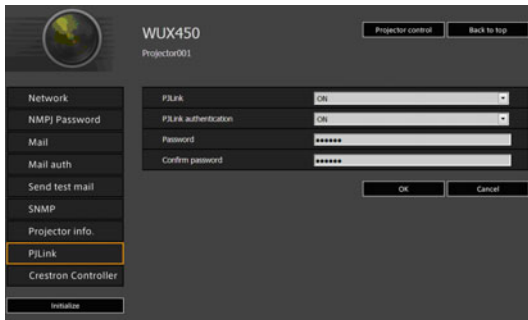

Item	Explanation	Factory default setting
PJLink	Turn the PJLink function on or off. If OFF is selected, the PJLink function will be turned off and the other settings in this screen cannot be changed.	ON
PJLink authentication	Select whether to turn the PJLink authentication function on or off. If OFF is selected, [Password] and [Confirm password] cannot be changed.	ON
Password	Enter the PJLink authentication password in 1-byte alphanumeric characters (1 - 32 characters).	system
Confirm password	For confirmation, enter the same password that you entered in [Password].	system

### Setting Up a Controller Manufactured by Crestron Electronics [Crestron Controller]

From [Crestron Controller] in the settings screen, you can set parameters for communication via controllers manufactured by Crestron Electronics.

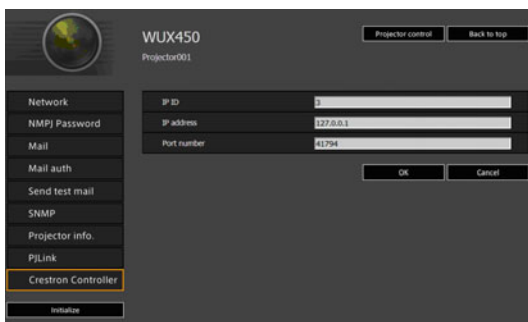

## Completing Computer Settings

Item	Explanation	Factory default setting
IP ID	Specify the controller's IP ID.	3
IP address	Specify the controller's IP address.	127.0.0.1
Port number	Specify the controller's port number.	41794

## Setting Errors

When a setting-related error occurs, the error name is displayed on the screen, and a “!” mark is displayed next to the input field which caused the error.

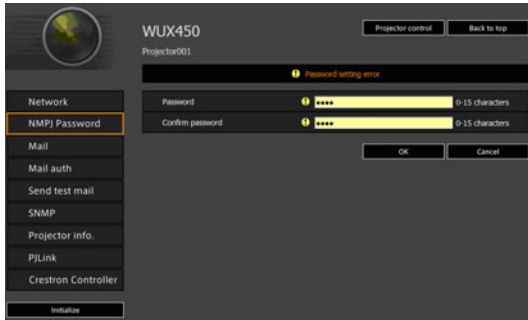

The error meanings are as shown below.

Error	Meaning
Input error	A setting outside the valid range was set on the settings screen.
Password setting error	The set password and confirmation password did not match.
Invalid SMTP	The SMTP server IP address has not been set.
System failed to connect SMTP server.	Failed to connect to the SMTP server when sending a test mail.
System failed to connect POP3 server.	Failed to connect to the POP3 server attempting to send a test mail.
System doesn't support this auth type.	An authentication type was set which is not supported by the server.
System failed to authenticate.	Authentication failed attempting to send a test mail.
The system failed to send the test mail.	Sending of test mail failed due to a connection failure with the SMTP server or an error which does not ordinarily occur.
Unknown error	Unknown error



## Resetting Network Settings to the Default Settings

- 1 Perform steps 1 - 3 on “Displaying the Network Configuration Screen” (P181) to display the settings screen.
- 2 Click [Initialize].



- 3 A confirmation window appears. Click [OK].

### ■ Error Notification Mails

The messages shown in the following error list are sent when an error occurs in the projector.

#### Error list

Errors related to temperature	Error name	Temperature abnormality
	Text	The temperature inside the projector is too high for some reason or the outside air temperature is higher than the specified one. If the problem is inside the projector, check whether the projector is installed and operated normally, turn off the projector to cool its inside, and retry projection. If the same warning occurs again, the projector may be defective. Contact your dealer.
Errors related to the lamp	Error name	Faulty lamp
	Text	The lamp has burnt out. Replace the lamp with a new one. If the same warning occurs again, the lamp drive circuit may be defective. Contact your dealer.
Errors related to the fan	Error name	Faulty cooling fan
	Text	The cooling fan or another component may be defective. Contact your dealer.
Errors related to the air filter	Error name	Faulty air filter unit
	Text	The air filter unit is not installed properly. Check whether the air filter unit is installed properly. If it is installed properly, the air filter unit detection switch may be defective. Contact your dealer.
Errors related to the power	Error name	Faulty power supply
	Text	The voltage of part of the power supply is abnormally high or any other problem has occurred in the power supply. Contact your dealer.

## Control via the Web Screen

When the projector is connected to a network, it is possible to control the projector from a computer via the network.

- 1 Turn on the computer and projector.**
- 2 Launch a web browser, enter “http://(projector IP address)” in the address bar, and press the Enter key.**  
The projector web screen appears.

 The factory default IP address is “192.168.254.254”. If DHCP settings are used, ask the network administrator for the projector IP address. It is possible to check the IP address from the projector menu.

- 3 Click [Projector control] on the web screen.**  
The password input window appears.
- 4 Enter the user name and password on the password input window, then click [OK].**  
The factory default user name is “root” and the password is “system”.

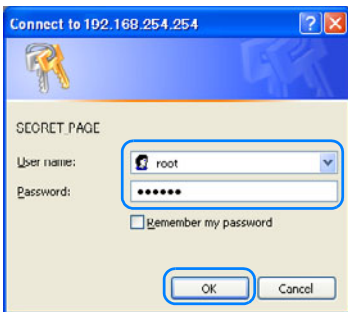

[Projector control] screen appears.

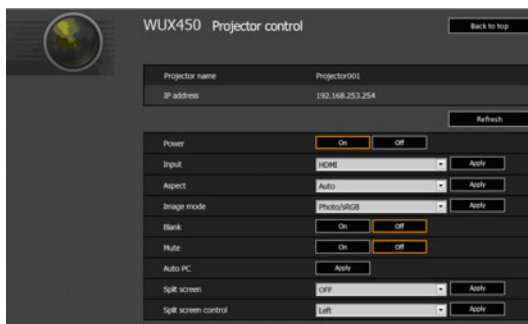

The projector control screen appears. The projector can be controlled from this screen.

## Completing Computer Settings

Item	Explanation
Projector name	The name of the connected projector is displayed. (P190)
IP address	The IP address of the connected projector is displayed. (P195)
Refresh	Refreshes the displayed contents with the most recent information.
Power	Turns projector power on or off.
Input	Select an input signal and click [Apply] to change to that input signal. (P53)
Aspect	Select an aspect and click [Apply] to change to that aspect. (P66)
Image mode	Select an image mode and click [Apply] to change to that image mode. (P71)
Blank	Switches the blank setting on or off. (P76)
Mute	Switches the mute setting on or off. (P77)
Auto PC	Click [Apply] to perform Auto PC adjustment. (P57)
Split screen	Select the setting for split-screen mode and click [Apply] to switch to split-screen projection.
Split screen control	Select the control rights setting for split-screen mode and click [Apply] to switch the side currently under control.
Information	The control results and control error information are displayed at the top of the screen.

- 5** When the operations are finished, click [Back to top] to return the initial web screen.

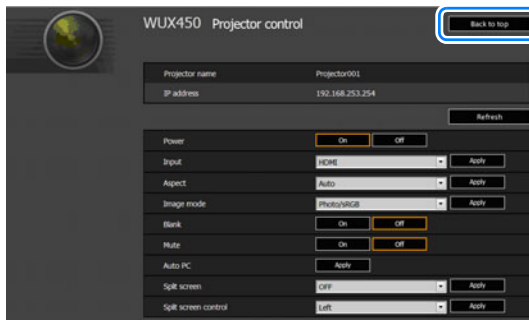

# Maintenance

Table of Contents

Safety Instructions

Before Use

## Operation

Projecting an Image

Useful Functions Available  
During a Presentation

Setting Functions from  
Menus

## Installation and Maintenance

Installation

Connecting to a Network

Maintenance

## Networked Multi-Projection

Networked Multi-Projection  
Overview

Operation in Each Mode

Functions in All Modes

## Appendix

Other Information

Index

# Cleaning the Projector

Clean the projector frequently to prevent dust from settling on the surface. A dirty lens may ruin the quality of the projected image.



**When cleaning the projector, make sure to turn off the projector, wait until the cooling fan stops, disconnect the power plug from the electrical outlet, and let the projector stand for at least 1 hour. Otherwise, you may get burned because the main unit is very hot immediately after the projector is turned off.**

Wipe the projector's main unit softly with a soft cloth. If the projector is heavily soiled, soak the cloth in water with a small amount of detergent in it, squeeze the cloth thoroughly, and then wipe the projector with it. After cleaning, wipe the projector with a dry cloth.



- Never use volatile cleaning liquid or benzene, as these may damage the finish of the projector.
- When using a chemical dust cloth, make sure to read the instructions thoroughly.
- When cleaning the projector's lens, use a commonly available air blower or lens cleaning paper. The lens surface is easily damaged, so do not use a hard cloth or tissues.

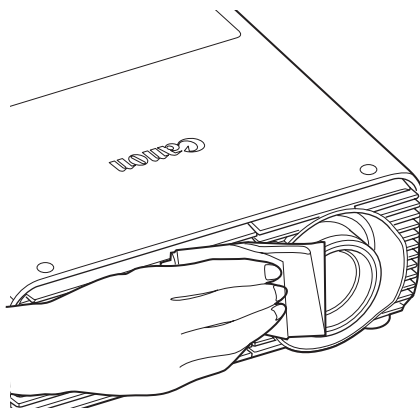

# Cleaning and Replacing the Air Filter

## Replacing the Air Filter

Follow the procedure below when replacing the air filter.

- 1** Turn off the projector power and remove the power plug.
- 2** As you press the top and bottom of the air filter cover to release the lock, remove the cover.

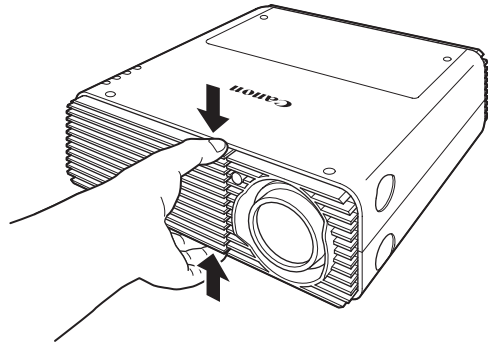

- 3** Open the filter cover and remove it.

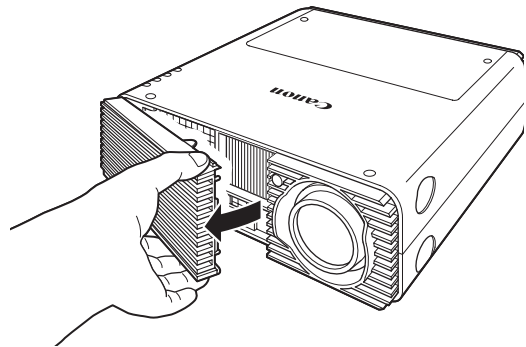

- 4** Remove the air filter.

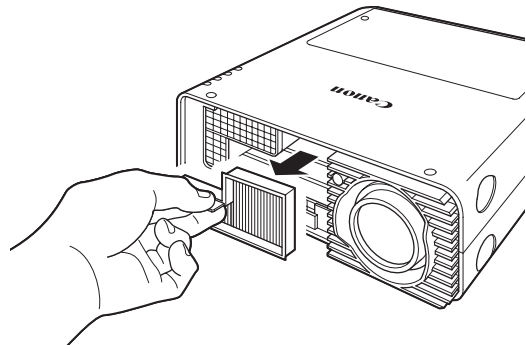

### 5 Follow this procedure in reverse to install a new air filter.



- Handle the air filter carefully. If damaged, the air filter will not work properly.
- When the lamp is replaced, it is recommended that you also clean or replace the air filter.
- Contact the Canon Customer Support Center for further information.
- Replacement air filter part number: RS-FL02
- This can also be purchased from the Canon website.

## Cleaning the Air Filter

The air filter protects the lens and mirror inside the projector from dust and dirt. Should the air filter become clogged with dust, the projector may be damaged since it will block the air flow into the projector and raise the internal temperature of the projector. The following screen is displayed when turning on the projector if the air filter needs to be cleaned (after approx. 300 hours). Clean the air filter if it is displayed.

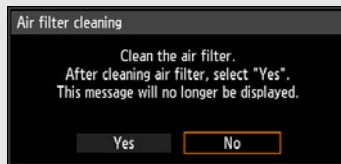

- Only the [◀], [▶], **OK** and **POWER** buttons are available while this screen is displayed. (When you press the **POWER** button, the “Push POWER button again to turn off power.” message appears.)
- When this screen has disappeared after being displayed for 10 seconds, all buttons become operable.

- Turn the power of the projector off and pull out the power plug.
- Hook your finger around the air filter handle on the front of the projector and remove the air filter. Use a vacuum cleaner to clean off the dust.
- If the air filter cleaning screen is displayed when turning on the projector after cleaning the air filter, select [Yes] and press the **OK** button. The air filter cleaning screen will disappear.
- This screen is not displayed when [Air filter warning display] is set to [Off]. (P157)



Do not rinse the air filter in water, which may damage the air filter and projector.



# Replacing the Lamp

When the usage time of the lamp exceeds a certain amount of time, the following message (two types) is displayed for 10 seconds every time the projector is turned on.

## 2,700 hours or less than 3,000 hours



Prepare a new lamp when this screen is displayed.

- Only the [◀], [▶], **OK** and **POWER** buttons are available while this screen is displayed.
- When you press the **POWER** button, the “Push POWER button again to turn off power.” message appears.
- When this screen has disappeared after being displayed for 10 seconds, all buttons become operable.
- This message will not be displayed again if you select [No] in response to the message “Do you want to display this message again?”.

## 3,000 hours or more

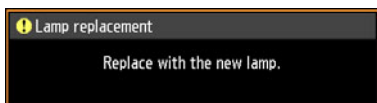

If this screen is displayed, replace the lamp by referring to the procedure on [page 202](#).

- Only the **POWER** button is available while this screen is displayed.
- When you press the **POWER** button, the “Push POWER button again to turn off power.” message appears.
- When this screen has disappeared after being displayed for 10 seconds, all buttons become operable.
- You can check the usage time of the lamp in [Lamp counter] in the [System settings] menu. (P119)
- This screen is not displayed when [Lamp warning display] is set to [Off]. (P156)

# Replacement Lamp

This projector uses the following lamps.

Lamp part no.: RS-LP08

Contact the Canon Customer Support Center when purchasing a replacement lamp.



### Precautions when replacing lamps that stop working

If the illumination suddenly stops when the projector is in use or after you turn it on, the lamp may be broken. In this case, never attempt to replace the lamp by yourself. Always request service from the Canon Customer Support Center. Additionally, with ceiling-mounted projectors, the lamp may fall out when you open the lamp cover or while you are attempting to replace it. During replacement, stand to the side of the lamp cover, not directly under it. If the lamp breaks and any glass shards or other pieces get in your eyes or mouth, consult a doctor immediately.



When replacing the lamp, turn off the projector, wait until the cooling fan stops, disconnect the power plug from the electrical outlet, and let the projector stand for at least 1 hour. Otherwise, you may get burned because the main unit is very hot immediately after the projector is turned off.



- Be sure to use the specified lamp.
- Contact the Canon Customer Support Center for further information. This can also be purchased from the Canon website.
- Do not touch the inner glass surface when you replace the lamp. Doing so may cause deterioration to the projector's performance.
- Be sure to handle the lamp carefully and correctly since it may break during use if it has been scratched or subjected to impact. If the lamp breaks, contact the Canon Customer Support Center or follow the instructions on [P26](#) and [P27](#).
- When replacing the lamp, do not remove any screws other than those specified.

## Replacing the Lamp

- 1 Turn off the projector power and remove the power plug.
- 2 Press the lamp cover release button to release the lock.

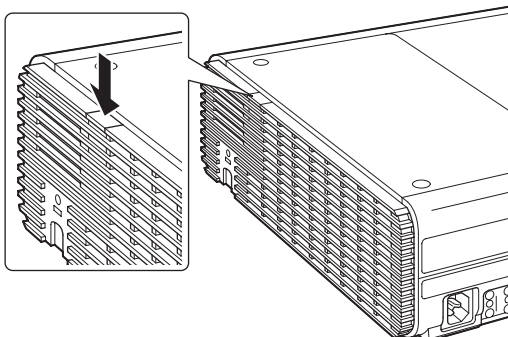

- 3** As you hold down the lamp cover release button, slide the lamp cover toward the back, and then lift the cover to open it.

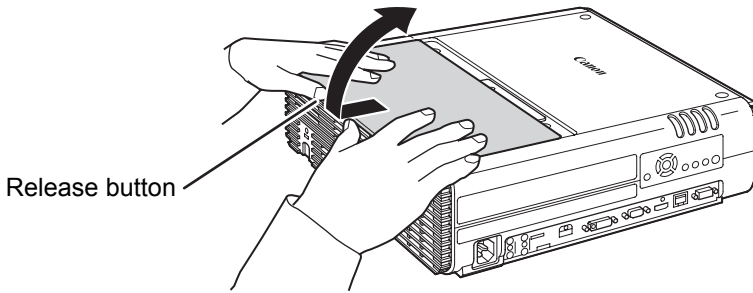

**Caution** As you slide the lamp cover toward the back, be careful not to pinch your fingers between the lamp cover. We recommend using both hands to slide the cover, as shown.

- 4** Loosen the three screws securing the lamp unit.

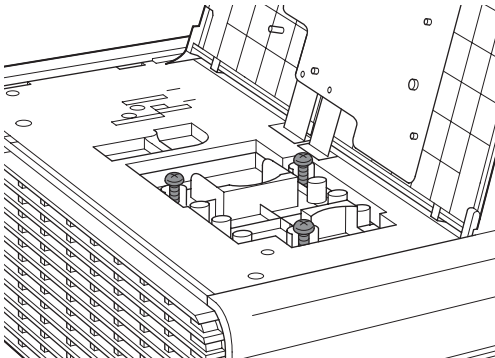

- 5** Remove the lamp unit.

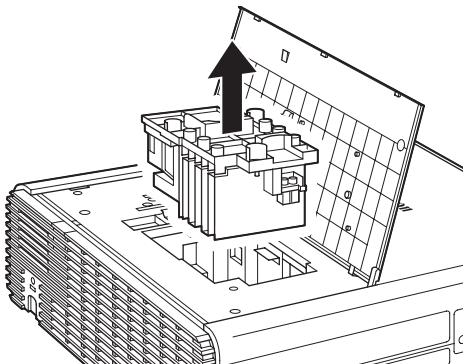

- 6** Follow this procedure in reverse to install a new lamp unit.

## Replacing the Lamp

- 7 Turn on the power. Bring up the menu and select [System settings] - [Other settings] - [Lamp counter].

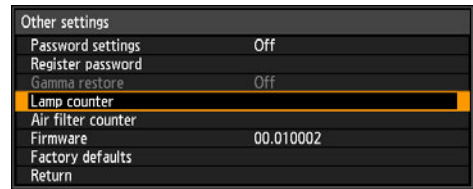
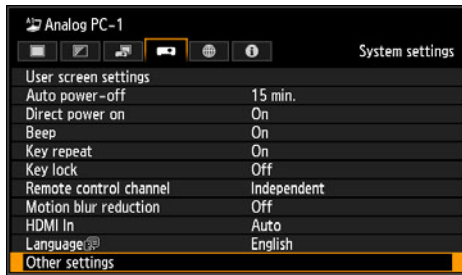

- 8 Select [Reset] - [Yes] to reset the lamp counter.

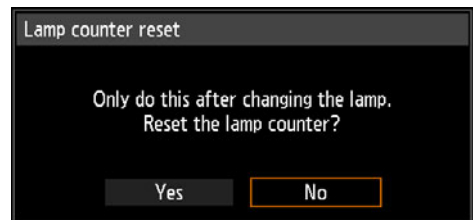

- We recommend cleaning or replacing the air filter (part no.: RS-FL02) when you replace the lamp.
- Contact the Canon Customer Support Center for further information.

### ■ If the Lamp Cover Comes Off

Align the point of attachment on the lamp cover with the groove on the projector and gently push the lamp cover to attach it.

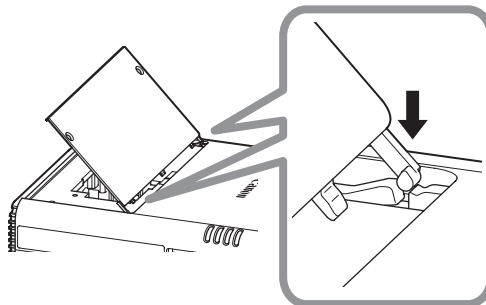

MULTIMEDIA PROJECTOR

**WUX450**

**WX520**

**WUX400ST**

**WX450ST**

# **Networked Multi- Projection (NMPJ)**





# Networked Multi-Projection Overview

Table of Contents

Safety Instructions

Before Use

## Operation

Projecting an Image

Useful Functions Available During a Presentation

Setting Functions from Menus

## Installation and Maintenance

Installation

Connecting to a Network

Maintenance

## Networked Multi-Projection

Networked Multi-Projection Overview

Operation in Each Mode

Functions in All Modes

## Appendix

Other Information

Index

# Introduction to Networked Multi-Projection

## ■ Projection Over a Network

Networked Multi-Projection (NMPJ) is a projector function enabling projection of computer screens over a local network. Multiple computers and multiple projectors can be connected, for a variety of projection scenarios.

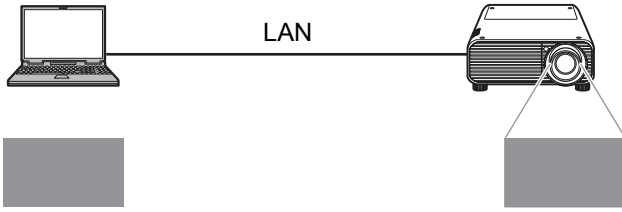

Links computers and projectors via a network connection.

## ■ Split-Screen Projection of Multiple Images

Images from multiple computers can be projected at once, with the images projected in separate areas of a single screen.

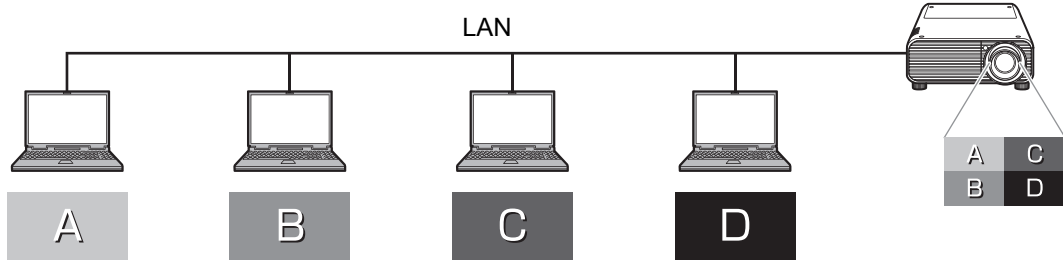

Projection of multiple computer screens in split-screen display.

## ■ Projection of an Image from Multiple Projectors at Once

Images from a single computer can be projected from multiple projectors at once.

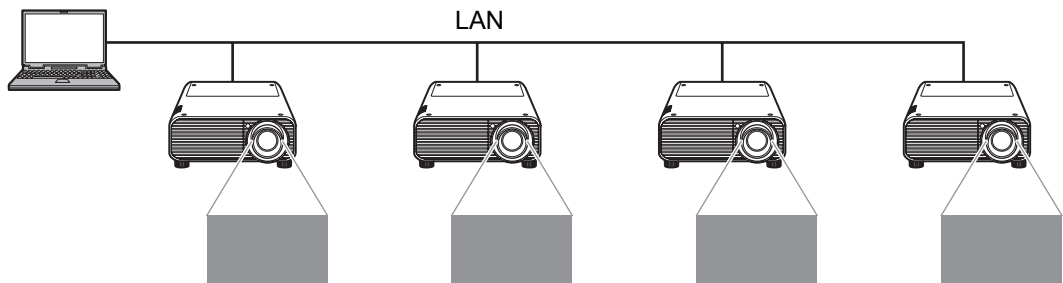



## ■ Selecting the Projection Monitor

For multi-monitor computers, you can project either the primary or secondary monitor.

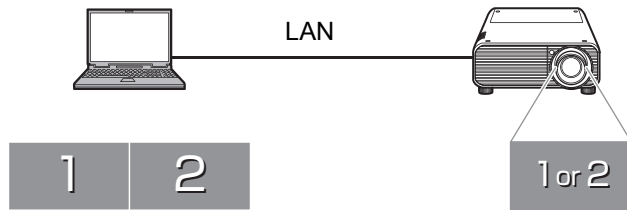

Select the primary or secondary monitor for projection

For each computer, you can select the monitor to project.

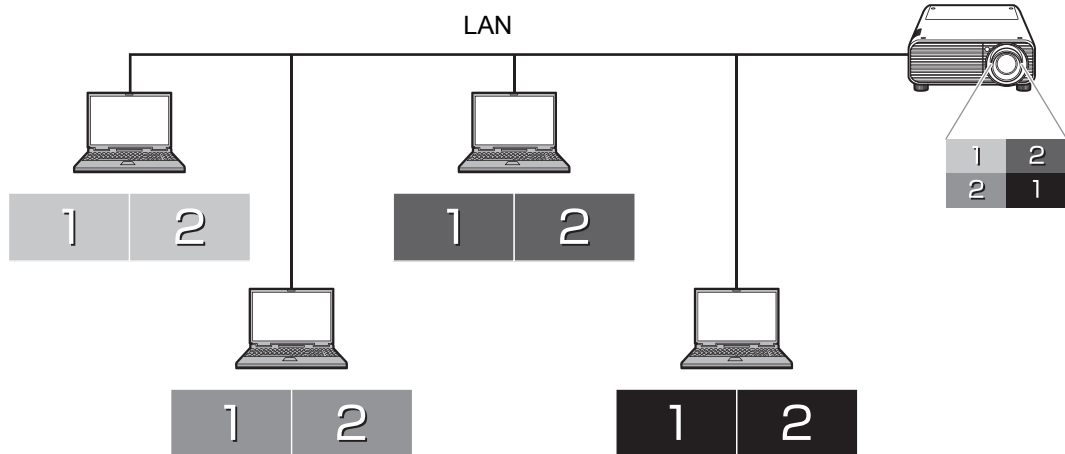

Select the primary or secondary monitor of each computer



- With some computers, it may not be possible to switch between projection of the primary and secondary monitor.
- The application responsiveness may decline when many computers and projectors are connected over the network.
- For computers that support three or more monitors, the monitor used for projection varies depending on the model of computer.

# Installing the NMPJ Application

To use the NMPJ function, you must install the NMPJ application.  
Instructions in this manual are for installation in a Windows 7 environment.

## System Requirements

Application system requirements are as follows.

<b>CPU</b>	Core 2 Duo P8600, 2.4 GHz or higher (32- or 64-bit)
<b>Memory</b>	1 GB or more
<b>HDD</b>	32 GB or more
<b>Monitor</b>	1024x768 min. resolution

 Cannot be installed on computers without a minimum resolution of 1024x768. Additionally, operation is not ensured if the resolution is switched to less than 1024x768 after installation.

### Operating System

Windows XP Professional SP3

Windows Vista Business SP2

Windows 7(Home/Professional/Ultimate) SP1

\* Windows XP and Vista compatibility is limited to 32-bit editions.

\* Both 32- and 64-bit editions of Windows 7 are supported.

-  • Operation is not ensured in other operating systems or editions.  
• Menus are in English in all cases, except in Japanese and Simplified Chinese versions of the application.  
• Operation is not ensured in operating systems other than English, Japanese, or Simplified Chinese OSes.  
• Operation is not ensured in Windows 8.

### Network

In TCP/IP network environments, projectors can be connected to computers via the following LAN connections.

Wired LAN (1000BASE-T, 100BASE-TX)

-  • Although the application also supports computer-projector communication over a router, operation is only ensured over one router hop. Additionally, to use Broadcast mode ([P249](#)) with projectors in other subnets, the router must support IPv4 multicast routing. Note that the router must be set up to route multicast addresses used by the application.  
• If you are using an Aero style in Windows, this message may be displayed: "Do you want to change the color scheme to improve performance?"

# Installation

The application is stored in the projector's internal memory. To install it on a computer, use a web browser on the computer to access the projector and download the application.



For instructions on connecting to the computer over a network, refer to “Connecting to a Network” (P167).

- 1 On the computer, start a web browser and connect to the projector.**  
For instructions on accessing the projector's web screen with a browser, refer to “Completing Computer Settings” (P178).

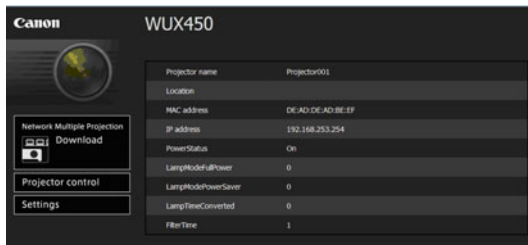

To check the projector's IP address, refer to the [Network settings] tab on the projector, or select [LAN] as the input signal.

- 2 Click [Network Multiple Projection Download].**
- 3 Click [Download].**

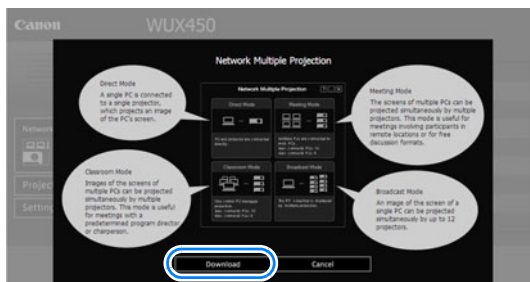

- 4 When a confirmation message is displayed, click [Run].**

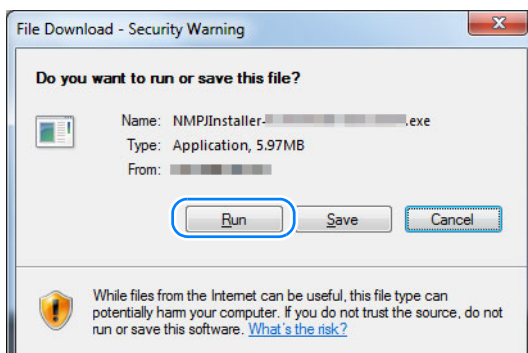

### 5 If a [User Account Control] message is displayed, click [Yes].

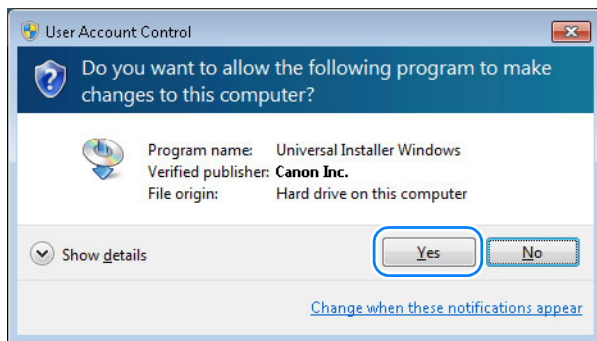

### 6 Next, follow the instructions displayed to complete the installation process.

- In Windows 7 and Windows Vista, confirmation or warning messages may be displayed during installation or uninstallation. These messages request administrator credentials from the current user. If you are logged in as a user with administrator credentials, click [Yes] (or [Continue]) to continue.
- Depending on the software, you may not be able to continue without administrator credentials. If you are logged in as a standard user, switch to an administrator account and try again.
- You may need to restart the computer to complete the installation process. If restarting is requested, be sure to restart the computer.

## ■ Uninstallation

- 1 Select [Start] > [All Programs] > [Canon NMPJ] > [Uninstall network multiple projection].

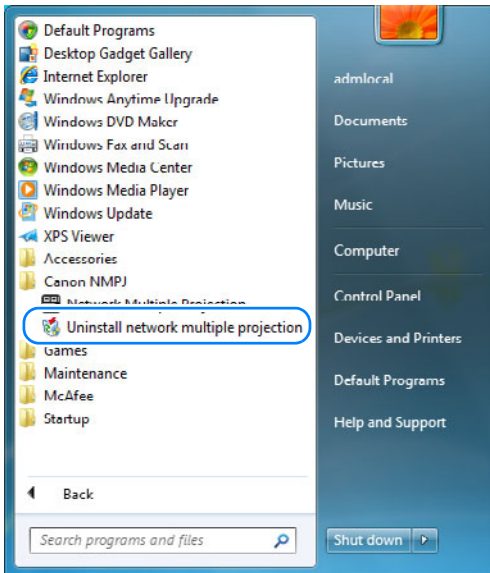

- 2 If a [User Account Control] message is displayed, click [Yes].

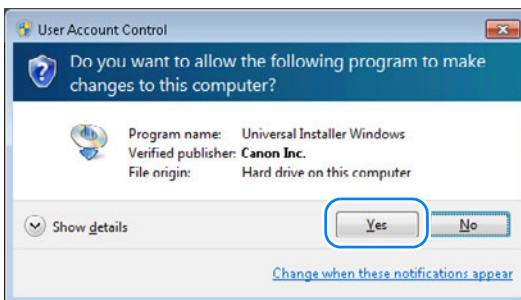

- 3 After the confirmation message is displayed, click [OK].

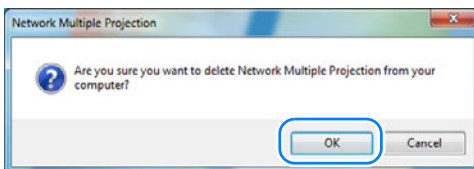

## Installing the NMPJ Application

- 4 After uninstallation is finished, click [OK] when the confirmation message is displayed.

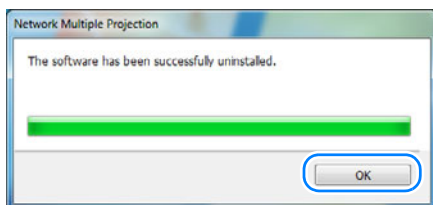

- ◆ You may need to restart the computer to complete the uninstallation process. If restarting is requested, always restart the computer.

- 5 Delete the following folder manually.

### Windows XP

C:\Documents and Settings\\Local Settings\Application  
Data\Canon\NMPJ

### Windows Vista

C:\Users\\AppData\Local\Canon\NMPJ

### Windows 7

C:\Users\\AppData\Local\Canon\NMPJ

- 📁 These files are hidden. To view hidden files in Windows Explorer, select [Folder options] > [View] > [Show hidden files, folders, and drives].

# From Startup to Shutdown

The procedure from application startup to shutdown is as follows. Example windows shown here are from Direct mode.

❗ If startup is not possible and a message is displayed indicating that NMPJSystem.dll could not be found, uninstall the application. If restarting is requested, always restart the computer. Reinstall the application and try again. (Do not attempt to install the application over an existing installation. Be sure to uninstall it first.)

## 1 Select [Start] > [All Programs] > [Canon NMPJ] > [Network Multiple Projection].

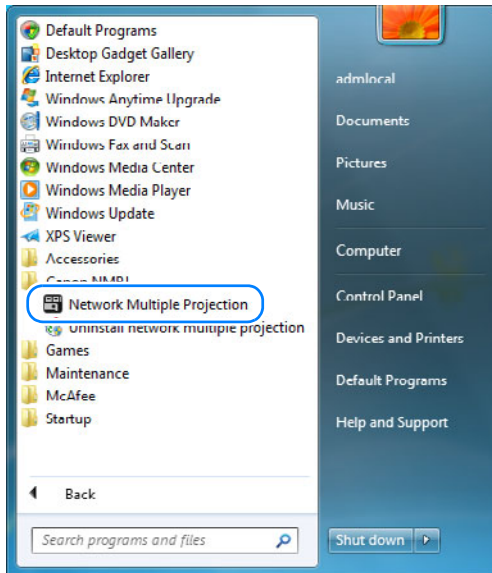

❗ **Windows Firewall**  
The following alert may be displayed the first time you start the application, depending on your Windows Firewall settings. To enable communication with projectors, select all check boxes and click the [Allow access] button.

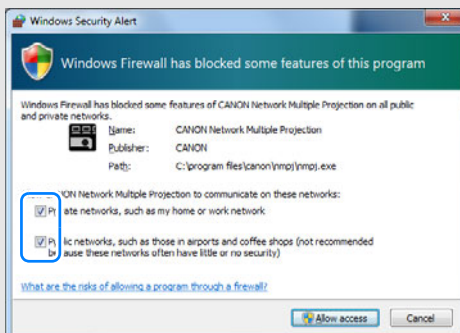

(Screen from Windows 7)

- 2** If the computer is equipped with multiple network adapters, a selection window is displayed. Click [OK] next to the desired network adapter.



The same three buttons are shown in the upper right of this window and subsequent windows. (Additional buttons are shown on some windows.)

- [ ? ] View application help.
- [ - ] Minimize the window to the taskbar. To view the window again, click the taskbar icon.
- [ X ] Close the window.

- 3** On the mode selection window, click the desired mode.

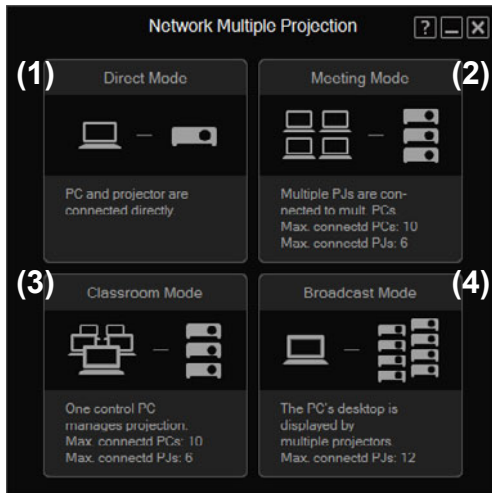

### (1) Direct Mode

When one computer is connected to one projector. (P224)

### (2) Meeting Mode

When multiple computers are connected to multiple projectors. Useful when showing multiple computer screens during meetings or other events. (P234)



**(3) Classroom Mode**

When multiple computers are connected to multiple projectors. Gives a single presenter control over the specific computer and projector used for projection. (P245)

**(4) Broadcast Mode**



When a single computer is connected to multiple projectors. Useful when multiple projectors are installed at various positions in an auditorium to project the same image. (P252)

**4 Depending on the mode, you can create, join, or select a projection session.****5 Click [Start projecting].**

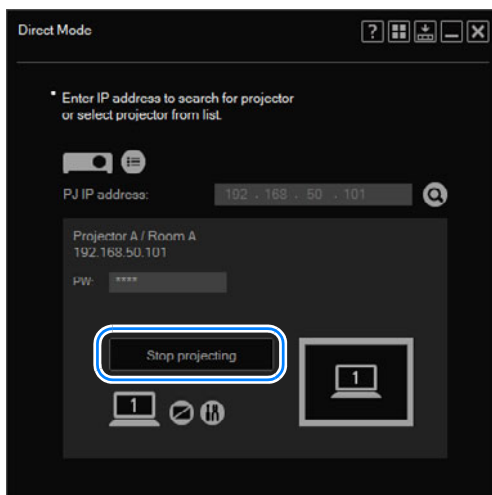
Click [Start projecting] on the window to start projection.

**6 To stop projection, click [Stop projecting].**

## From Startup to Shutdown

7 To return to the mode selection menu, click  or  in the upper right.

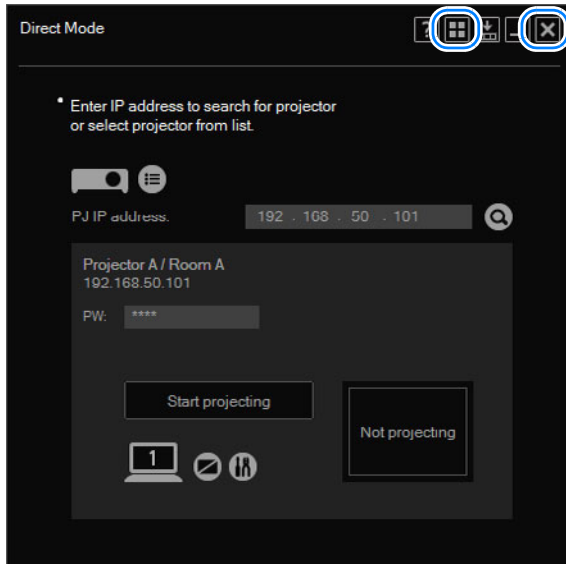

8 After a confirmation message is displayed, click [Return to menu].

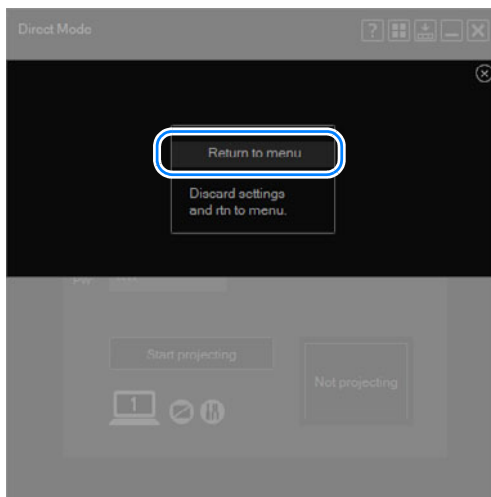

9 To exit the application, click  in the upper right of the mode selection menu.

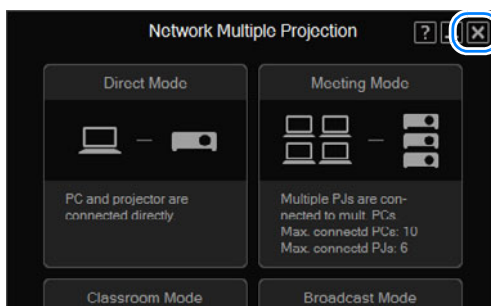

## ■ Projection Sessions

A session consists of all the computers and projectors used in projection. In Meeting and Classroom modes, the first user must create a session for the computers and projectors involved. Other users join the session by selecting it from a list of sessions. In Broadcast mode, users can create a session automatically by selecting a projector.



# Operation in Each Mode

Table of Contents

Safety Instructions

Before Use

## Operation

Projecting an Image

Useful Functions Available During a Presentation

Setting Functions from Menus

## Installation and Maintenance

Installation

Connecting to a Network

Maintenance

## Networked Multi-Projection

Networked Multi-Projection Overview

Operation in Each Mode

Functions in All Modes

## Appendix

Other Information

Index

# Using the Projector in Direct Mode

In this mode, one computer is connected to one projector over the network.

## Procedure

- 1 In the mode selection menu, select [Direct Mode].

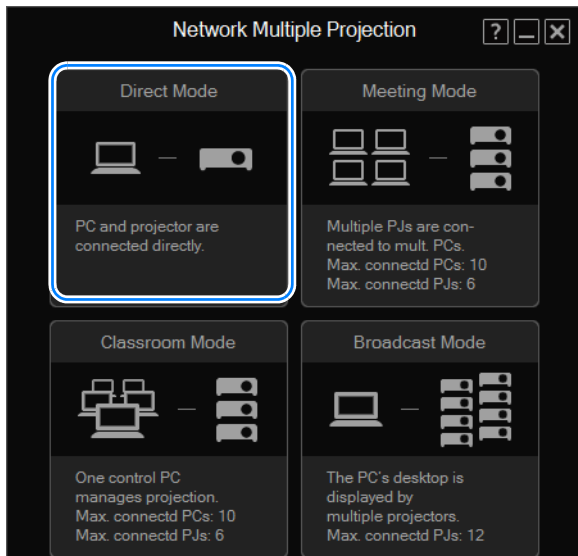

- 2 The Direct Mode window is displayed. Click  .



To connect to projectors in another subnet, enter the projector's IP address in the [PJ IP address] field and click .

- 3** The projector selection menu is displayed. Click the projector to connect to.

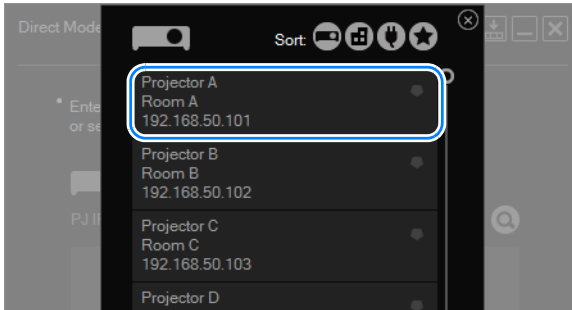

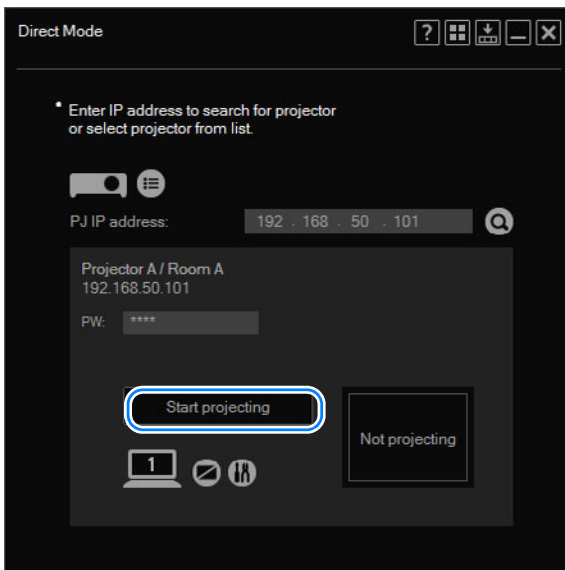

❗ For details on the projector selection menu, refer to “Using the Projector Selection Menu” (P258).

- 4** The Direct Mode window is displayed again. Click [Start projecting].



The computer screen is now projected.



- If the [NMPJ Password] setting has been configured on the projector's settings screen (P186), the password is now requested. Enter the password.
- To stop projection, click [Stop projecting].
- A BUSY icon (  ) indicates that the projector is not available, whether it is off, in use by other computers, or unavailable for other reasons. The BUSY icon (  ) is not updated automatically. To view updated projector status, select or search for projectors again.

## Direct Mode Window

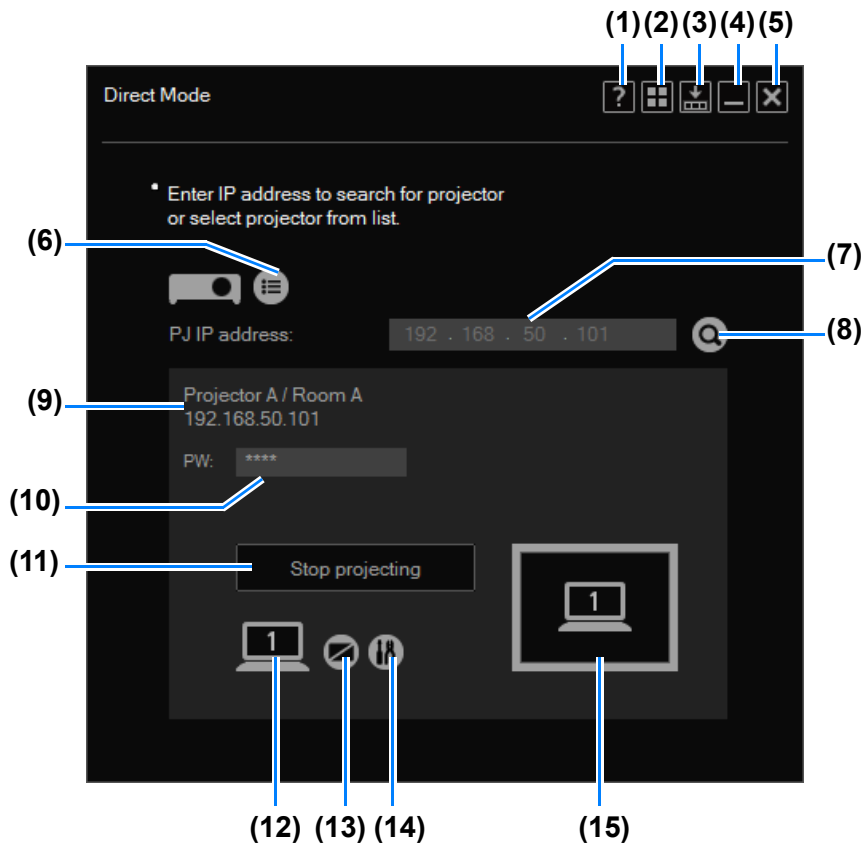

- (1) **Help**  
View application help.
- (2) **Back to mode selection**  
Return to the mode selection menu.
- (3) **Compact display**  
View the window at a compact size. ([P274](#))
- (4) **Minimize**  
Minimize the window to the taskbar. To view the window again, click the taskbar icon.
- (5) **Exit**  
Return to the mode selection menu.
- (6) **Projector list**  
View a list of projectors.



**(7) IP address**

To connect to projectors in another subnet, enter the projector's IP address here and click (8).

**(8) Find projectors**

Find the projector with the IP address entered in (7). Results of projector searching are shown in (9).

**(9) Projector information**

Indicates the name, installation location, and IP address of the projector selected in the list or found after searching by IP address.

**(10) Password**

Passwords for projectors on which [NMPJ Password] on the projector's settings screen has been configured ([P186](#)) must be entered here before projection.

**(11) Start**

Start projection by the selected projector. During projection, this button is labeled [Stop projecting] and can be clicked to stop projection.

**(12) Switch primary/secondary monitor**

A number is shown here only when secondary monitor connectivity is activated on the computer. Clicking the number will switch between the primary and secondary monitor.

**(13) Blank the projector**

Pause projection. Click again to resume projection.

**(14) Settings**

Display the settings window. ([P272](#))

**(15) Projection status**

Indicates the projection status.

# Using the Projector in Meeting Mode

In meeting mode, multiple computers are connected to multiple projectors. This mode is intended for group meetings where multiple computers are used. Up to ten computers and six projectors can be connected.

## Creating a Session

- 1 In the mode selection menu, select [Meeting Mode].

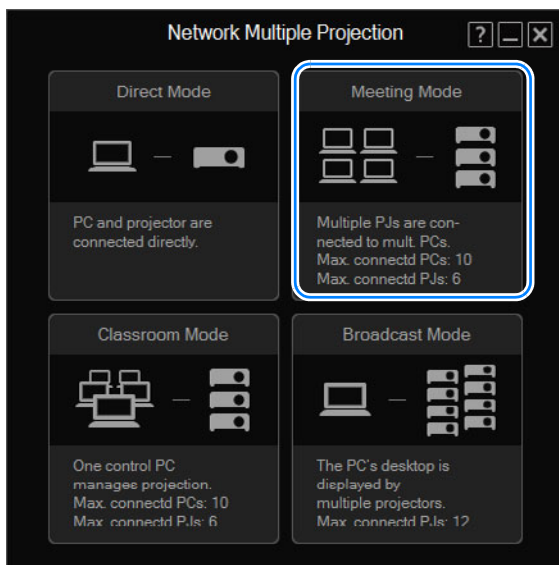

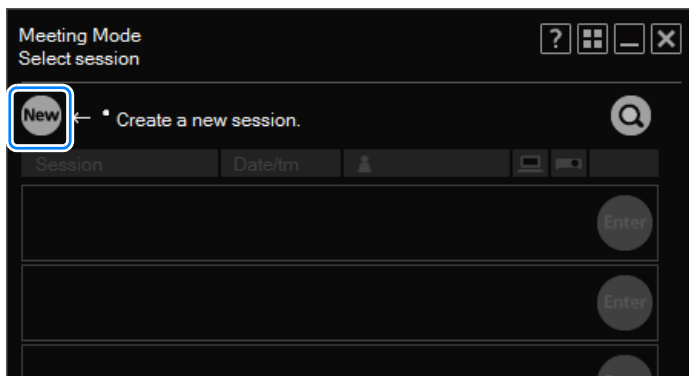

- 2 The session selection menu is displayed. Click [New].

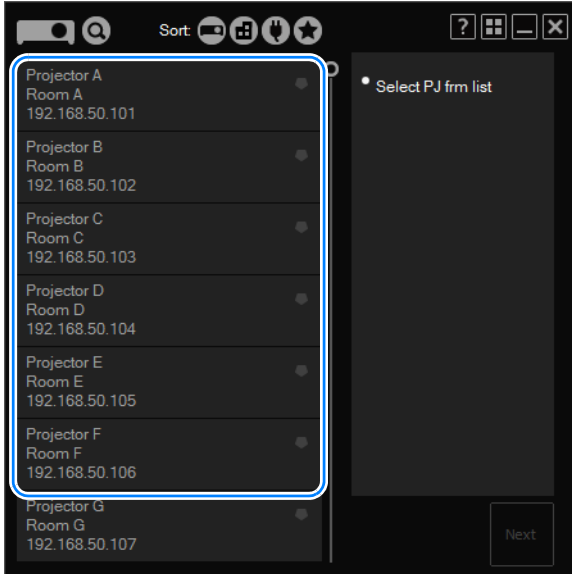

### 3 The projector selection menu is displayed. In the list of projectors at left, click the projector to connect to.

You can select up to 6 projectors. Selected projectors are listed at right.



- If the [NMPJ Password] setting has been configured on the projector's settings screen (P186), the password is now requested. Enter the password.
- To clear a selected projector, click  in the upper right of that projector listing.
- For details on the projector selection menu, refer to "Using the Projector Selection Menu" (P258).

### 4 Click [Next].



## Using the Projector in Meeting Mode

- 5** A window for creating the session is displayed. Specify a session name, password, nickname, and desktop (primary or secondary monitor for projection), and then click [OK].



- If you choose to set a session password, other users must enter that password to join the session. To set a password, click [Set] and enter the password.
- Desktop selection is only available with computers that have dual monitor support.

- 6** The Meeting Mode window is displayed. Select a projector to control from the pull-down list.

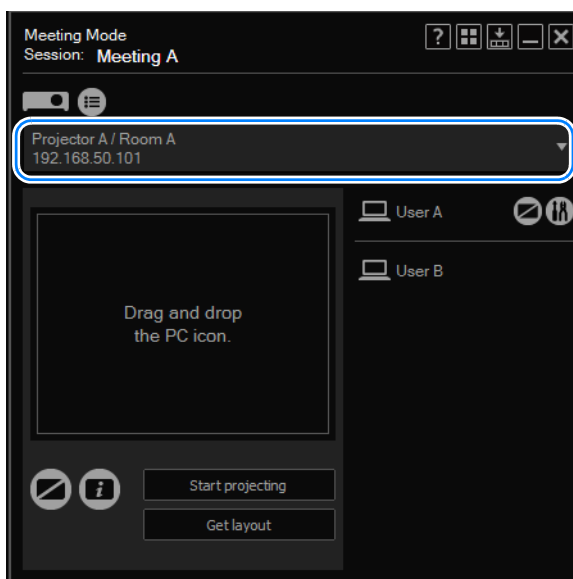

- 7** In the list at right, select a computer to use with your designated projector. Drag the computer to a desired position in the layout area. You can arrange up to four computers as desired in the layout area.

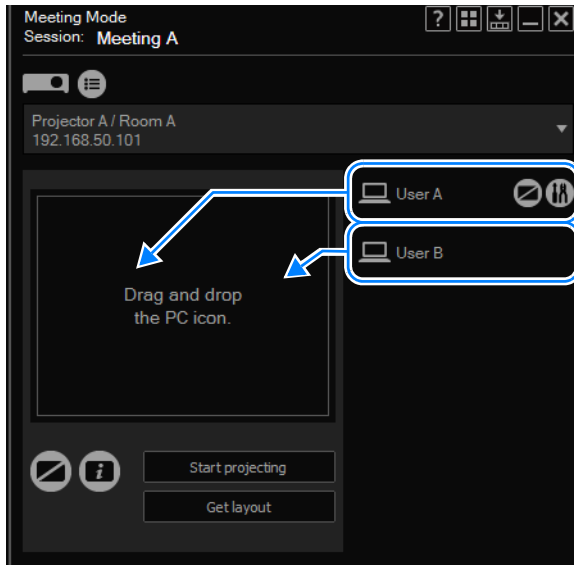

- 8** Drag the computers for use in projection in the layout area to rearrange them, as needed. During projection, screens of each computer will be arranged according to their position in the layout area.



### 9 Click [Start projecting].

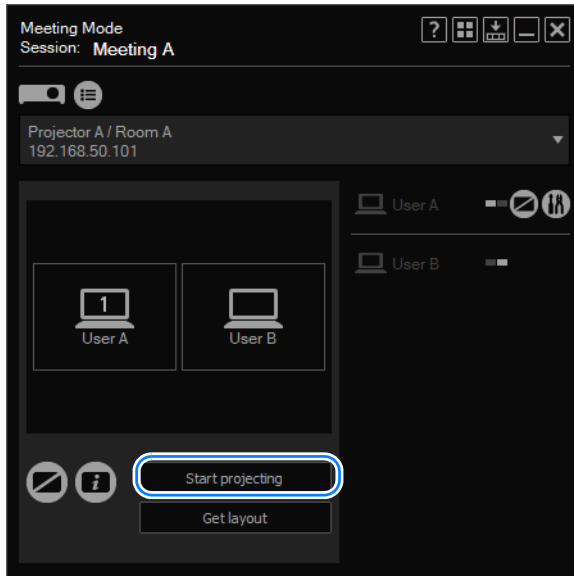

Images are now projected from the computers in the layout area.



- To stop projection, click [Stop projecting].
- To rearrange the layout during projection, click [Start projecting] again. Note that if you simply rearrange the layout, the new layout will not be applied to projection.

### 10 To end the session, click or in the upper right.

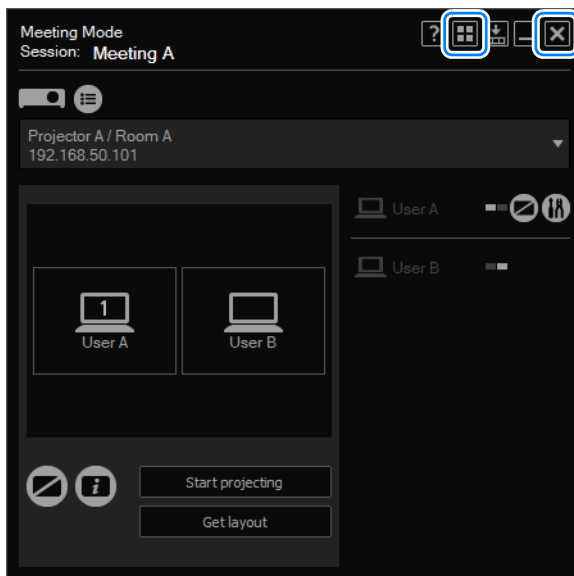

- 11** The following confirmation message is displayed. To end the entire session, click [Close]. To leave the session, click [Exit].

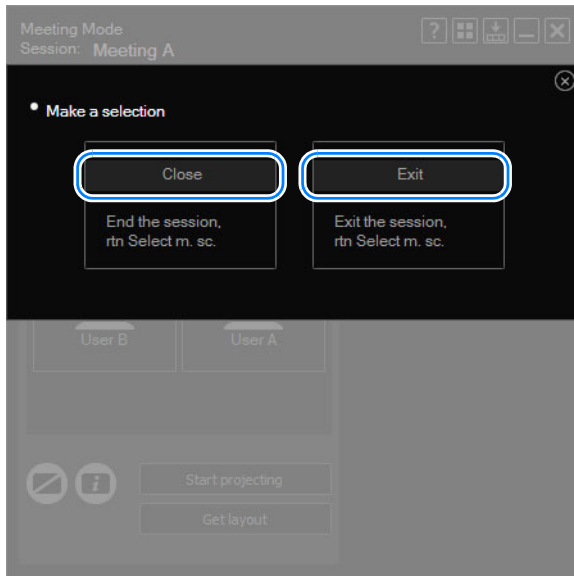

Return to the mode selection menu.



[Exit] is not shown unless other computers are connected.

# Joining a Session

- 1 In the mode selection menu, select [Meeting Mode].

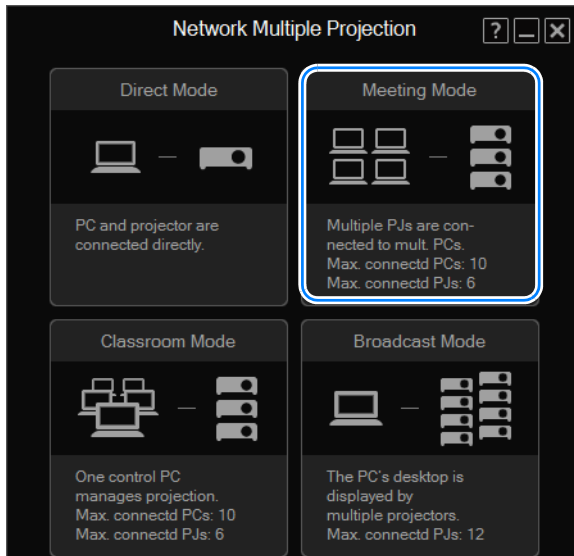

- 2 The session selection menu is displayed. Click [Enter] next to the session to join.

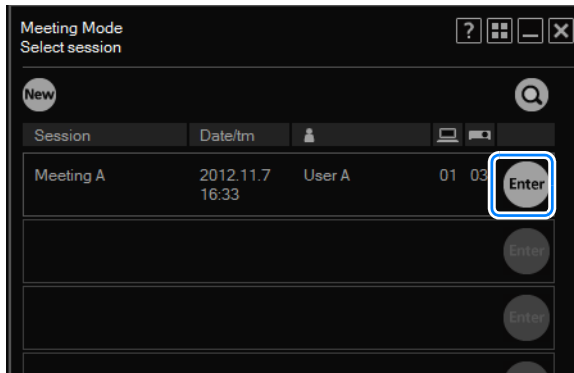

 To join a session in another subnet, click  and enter the projector's IP address to locate the projector. The application will search for sessions in the other subnet. For details, refer to "Using the Session Selection Menu" (P256).



- 3** A session login window is displayed. Specify the session password, your nickname, and desktop (primary or secondary monitor for display), and then click [OK].

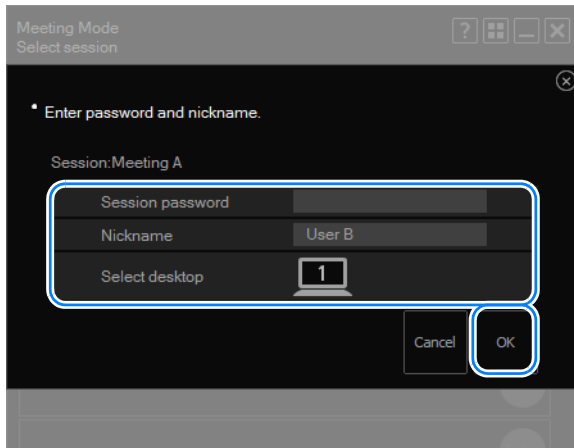

Desktop selection is only available with computers that have dual monitor support.

- 4** The Meeting Mode window is displayed. Next, follow the instructions starting with step 6 in “Creating a Session” (P226).

## Meeting Mode Window

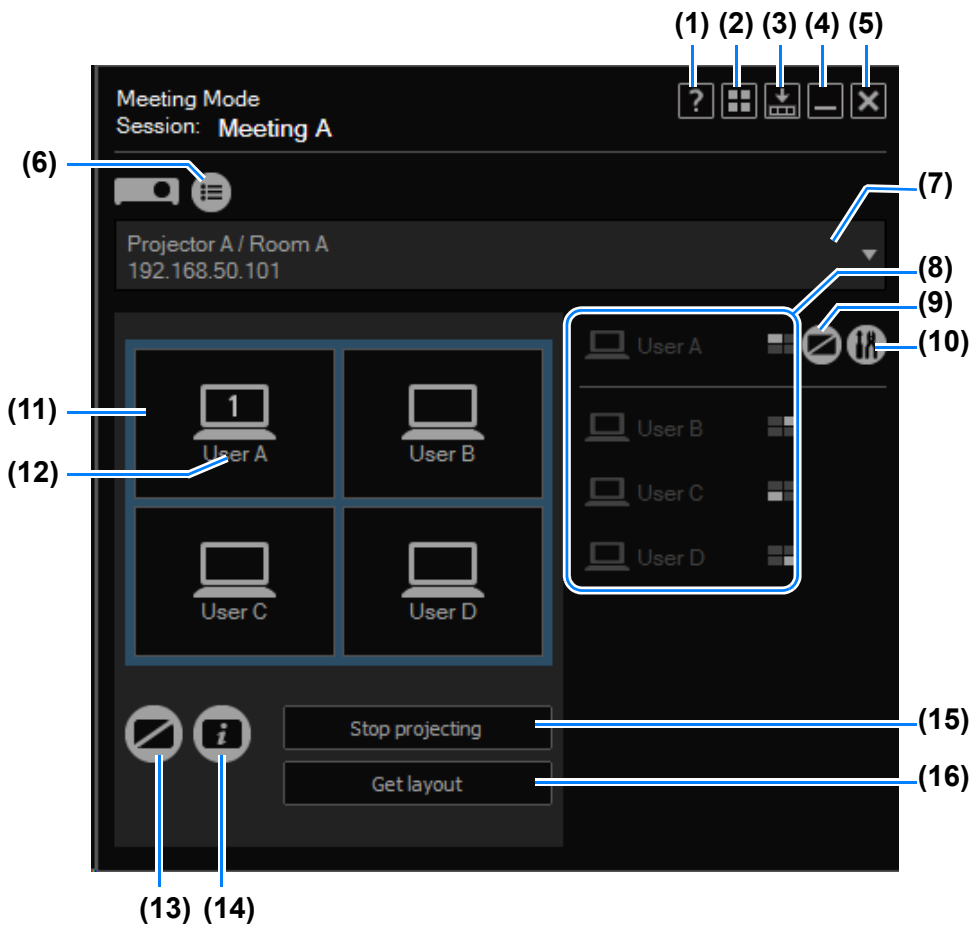

- (1) **Help**  
View application help.
- (2) **Back to mode selection**  
Return to the mode selection menu.
- (3) **Compact display**  
View the window at a compact size. (P274)
- (4) **Minimize**  
Minimize the window to the taskbar. To view the window again, click the taskbar icon.
- (5) **Exit**  
Return to the mode selection menu.
- (6) **Projector list**  
View a list of projectors.

- (7) Projector pull-down list**

Lists connected projectors. Your actions on this screen apply to the projector selected here.
- (8) Computers**

Lists connected computers. To prepare computers for projection, drag them to the layout area. Your own computer is listed first.  
In , the computer's display position is indicated by a white square.
- (9) Blank the computer**

Pause projection from the computer. Click again to resume projection.
- (10) Settings**

Display the setting window. ([P272](#))
- (11) Layout area**

Drag computers to this area to assign their projection position.
- (12) Computers in layout area**

Computers here can be dragged to rearrange them. A number is shown here only when secondary monitor connectivity is activated on the computer. Clicking the number will switch between the primary and secondary monitor.
- (13) Blank the projector**

Pause projection from the projector. Click again to resume projection.
- (14) View information**

Project information needed by other users to join the session. The IP address projected is used by one of the projectors in the session.
- (15) Start/stop projection**

Start projection by the selected projector. During projection, this button is labeled [Stop projecting] and can be clicked to stop projection.
- (16) Acquire screen layout**

Indicates the layout of the selected projectors.

# Using the Projector in Classroom Mode

In classroom mode, multiple computers are connected to multiple projectors. A single presenter can control any computer or projector used for projection, whether their own or those of others in attendance. Up to ten computers and six projectors can be connected.

## Leading a New Session

- 1 In the mode selection menu, select [Classroom Mode].

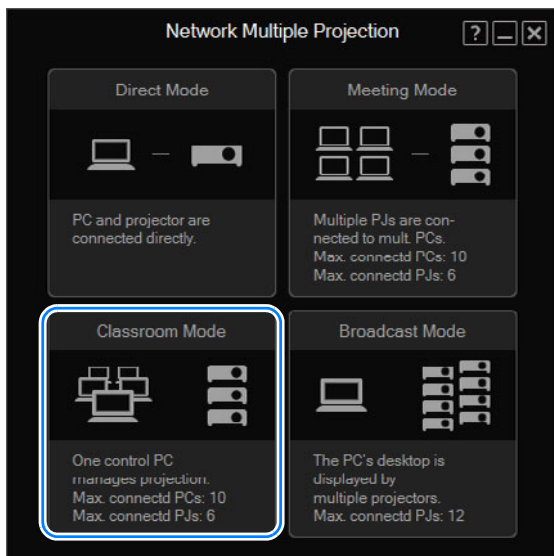

- 2 The session selection menu is displayed. Click [New].

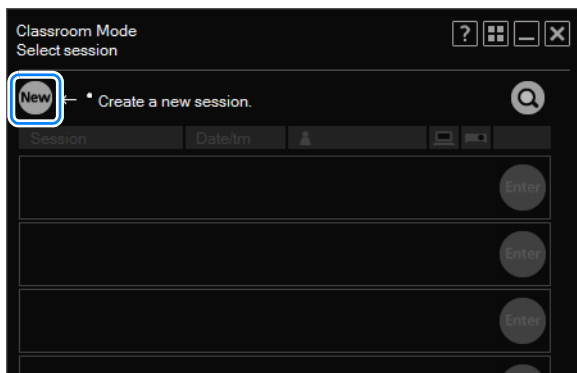

### 3 The projector selection menu is displayed. In the list of projectors at left, click the projector to connect to.

You can select up to 6 projectors. Selected projectors are listed at right.



- If the [NMPJ Password] setting has been configured on the projector's settings screen (P186), the password is now requested. Enter the password.
- To clear a selected projector, click  in the upper right of the projector listing.
- For details on the projector selection menu, refer to "Using the Projector Selection Menu" (P258).

### 4 Click [Next].



## Using the Projector in Classroom Mode

- 5** A window for creating the session is displayed. Specify a session name, password, nickname, and desktop (primary or secondary monitor for projection), and then click [OK].



- If you choose to set a session password, other users must enter that password to join the session. To set a password, click [Set] and enter the password.
- Desktop selection is only available with computers that have dual monitor support.

- 6** The Classroom Mode window is displayed. Select a projector to control from the pull-down list.

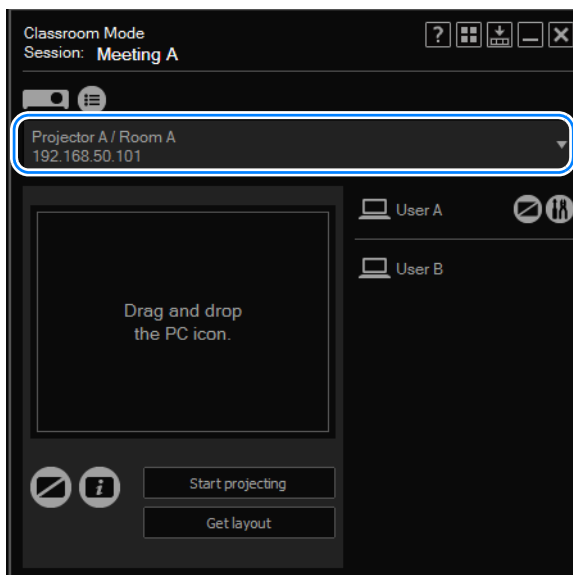

- 7** In the list at right, select a computer to use with your designated projector. Drag the computer to a desired position in the layout area. You can arrange up to four computers as desired in the layout area.

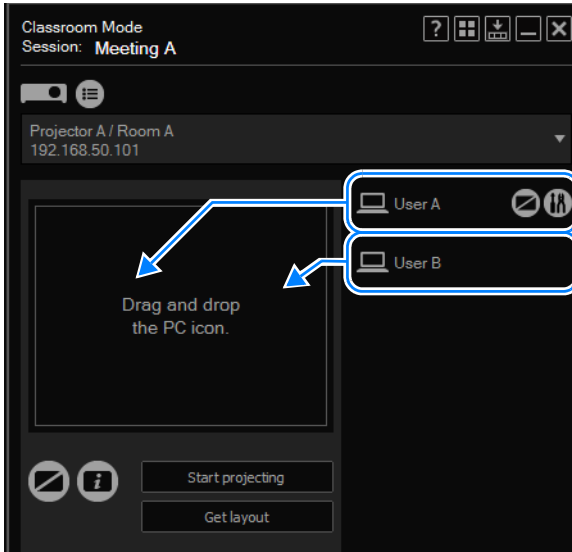

- 8** Drag the computers for use in projection in the layout area to rearrange them, as needed. During projection, screens of each computer will be arranged according to their position in the layout area.

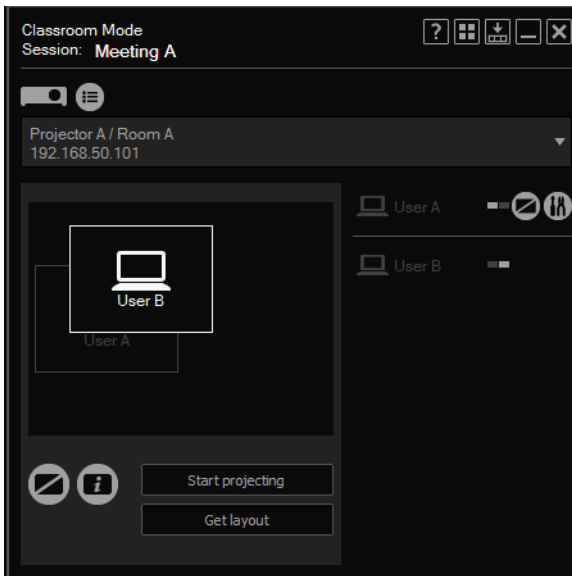

### 9 Click [Start projecting].

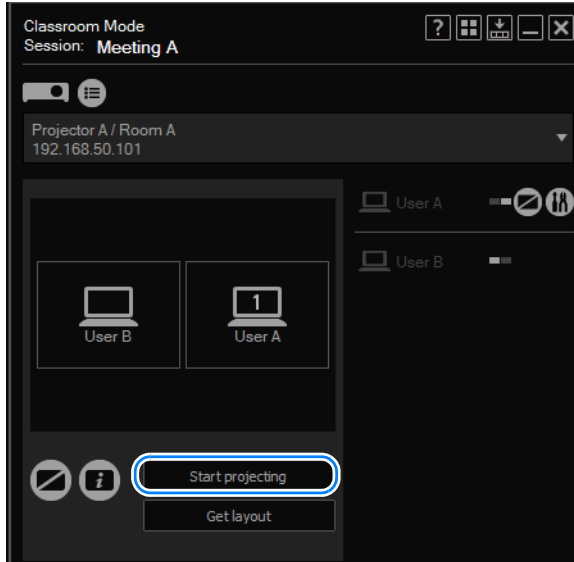

Images are now projected from the computers in the layout area.

- ❗ To stop projection, click [Stop projecting].
- To rearrange the layout during projection, click [Start projecting] again. Note that if you simply rearrange the layout, the new layout will not be applied to projection.

### 10 To end the session, click or in the upper right.

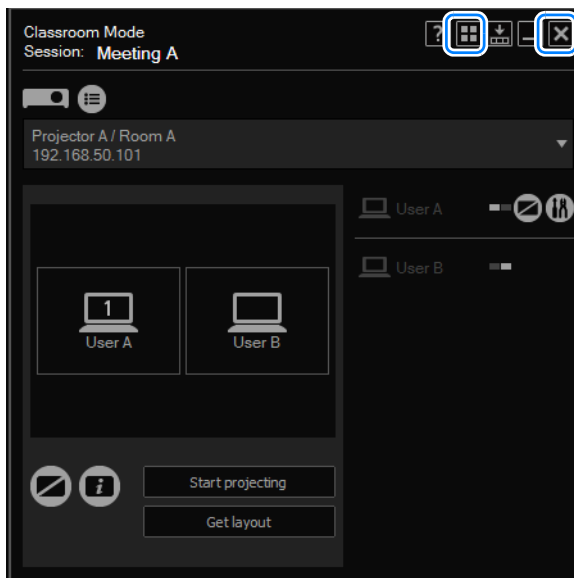



**11** The following confirmation message is displayed. Click [Close].

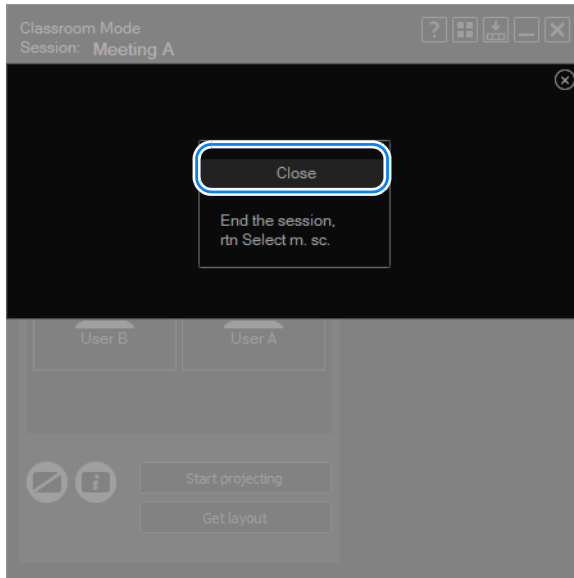

Return to the mode selection menu.

# Joining an Existing Session

- 1 In the mode selection menu, select [Classroom Mode].

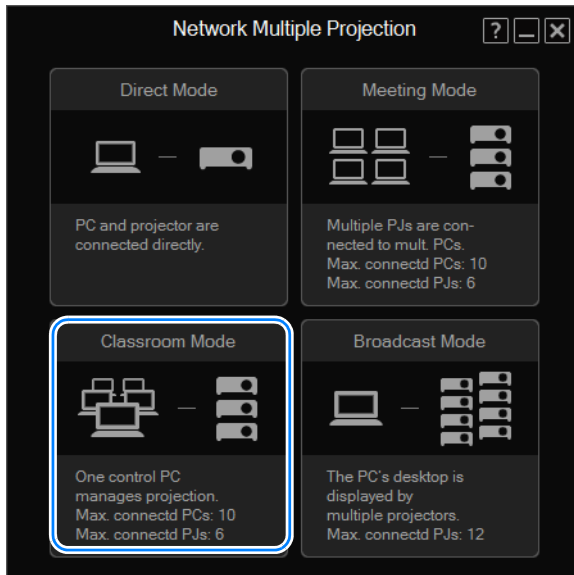

- 2 The session selection menu is displayed. Click [Enter] next to the session to join.

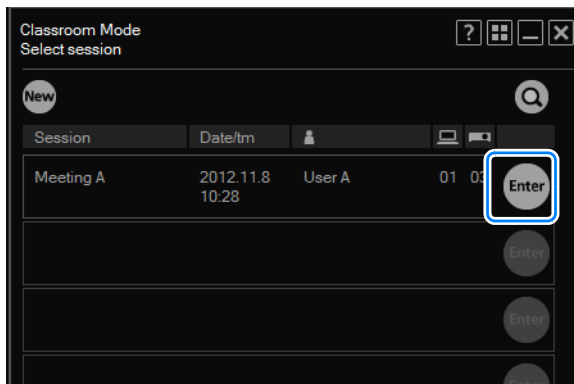

To join a session in another subnet, click  and enter the projector's IP address to find the projector. The application will search for sessions in the other subnet. For details, refer to "Using the Session Selection Menu" (P256).

- 3** A session login window is displayed. Specify the session password, your nickname, and desktop (primary or secondary monitor for display), and then click [OK].

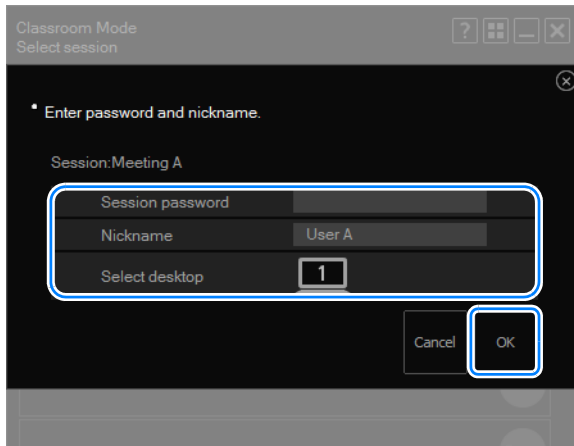

Desktop selection is only available with computers that have dual monitor support.

- 4** The Classroom Mode window (for joining a session) is displayed. Users joining sessions cannot change the projection layout or start or stop projection.

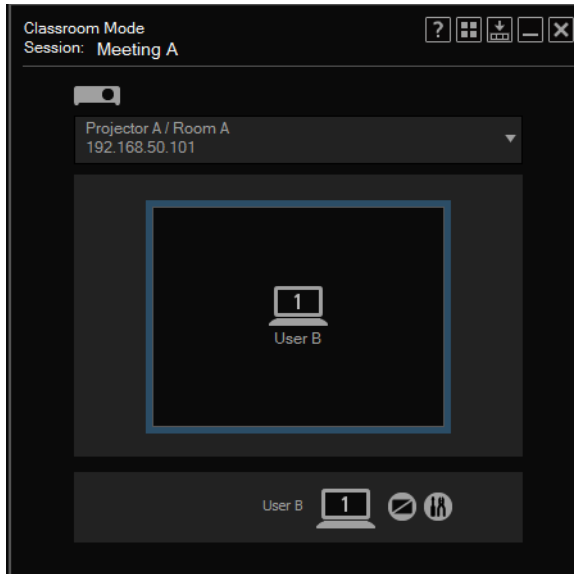

## Using the Projector in Classroom Mode

5 To end the session, click  or  in the upper right.

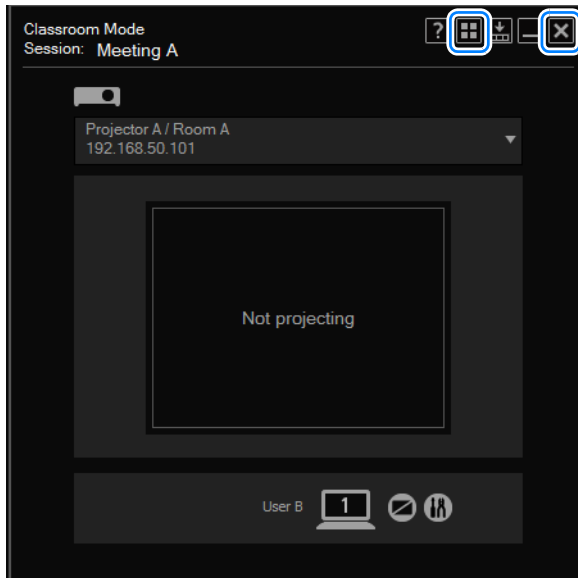

6 The following confirmation message is displayed. Click [Exit].

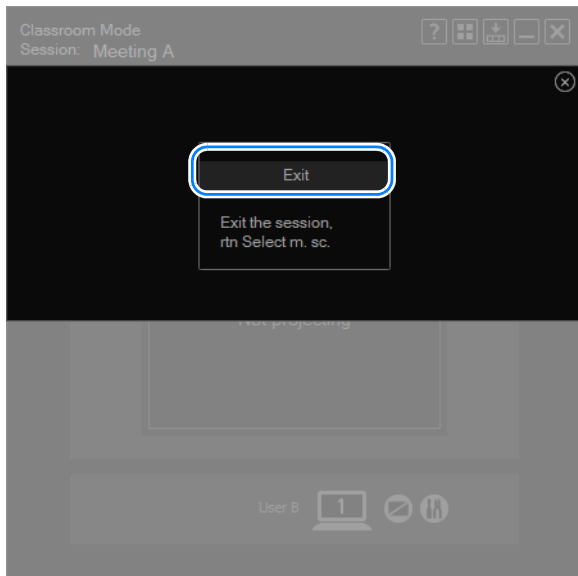

Return to the mode selection menu.

## Classroom Mode Window (Starting a Session)

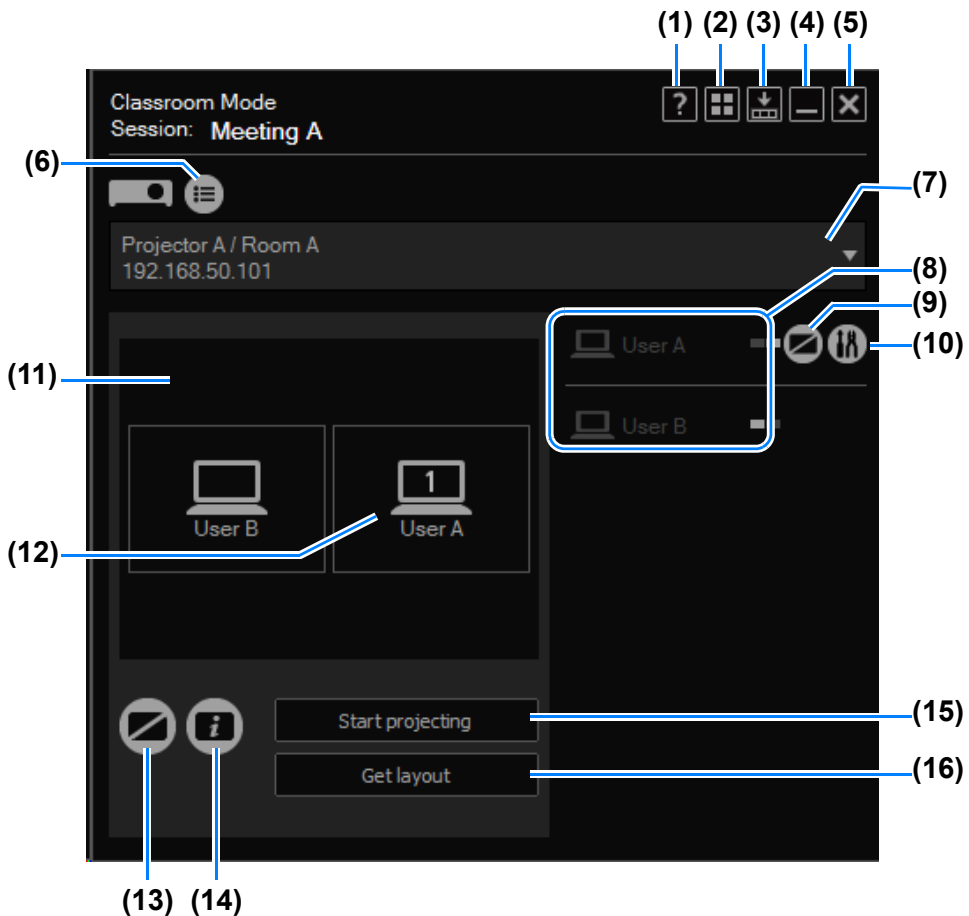

- (1) **Help**  
View application help.
- (2) **Back to mode selection**  
Return to the mode selection menu.
- (3) **Compact display**  
View the window at a compact size. (P274)
- (4) **Minimize**  
Minimize the window to the taskbar. To view the window again, click the taskbar icon.
- (5) **Exit**  
Return to the mode selection menu.
- (6) **Projector list**  
View a list of projectors.

## Using the Projector in Classroom Mode

### (7) Projector pull-down list

Lists connected projectors. Your actions on this window apply to the projector selected here.

### (8) Computers

Lists connected computers. To prepare computers for projection, drag them to the layout area. Your own computer is listed first.

In , the computer's display position is indicated by a white square.

### (9) Blank the computer

Pause projection from the computer. Click again to resume projection.

### (10) Settings

Display the setting window. ([P272](#))

### (11) Layout area

Drag computers to this area to assign their projection position.

### (12) Computers in layout area

Computers here can be dragged to rearrange them. A number is shown here only when secondary monitor connectivity is activated on the computer.

Clicking the number will switch between the primary and secondary monitor.

### (13) Blank the projector

Pause projection from the projector. Click again to resume projection.

### (14) View information

Project information needed by other users to join the session. The IP address projected is used by one of the projectors in the session.

### (15) Start/stop projection

Start projecting by the selected projector. During projection, this button is labeled [Stop projecting] and can be clicked to stop projection.

### (16) Acquire screen layout

Indicates the layout of the selected projectors.

## Classroom Mode Window (Joining a Session)

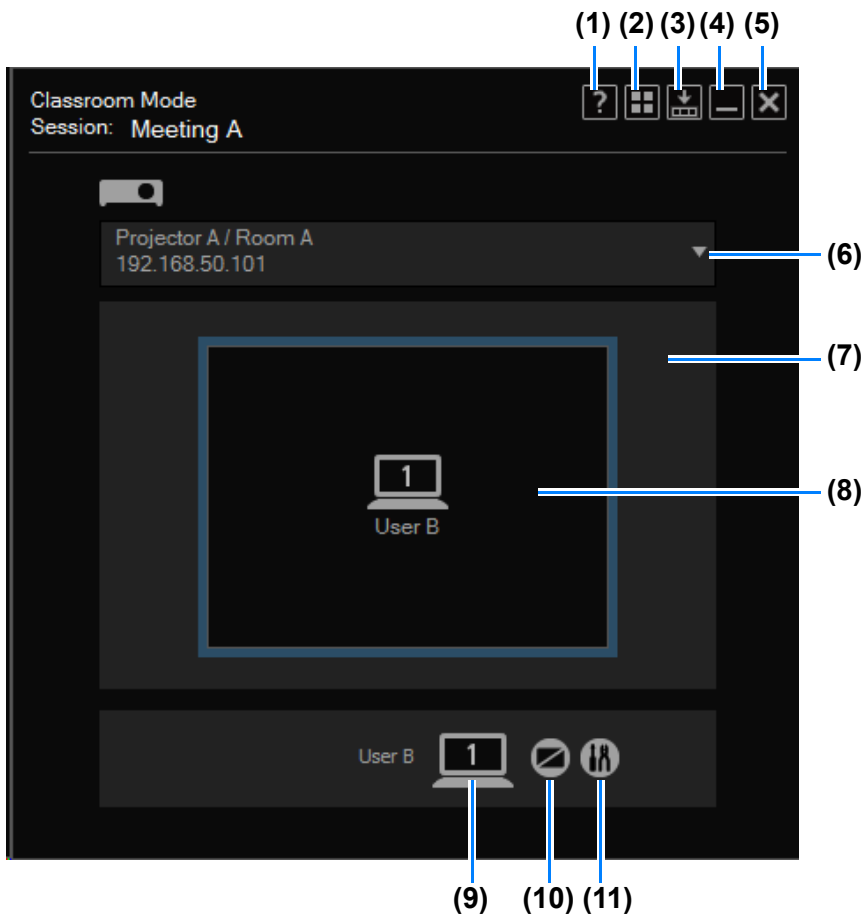

- (1) **Help**  
View application help.
- (2) **Back to mode selection**  
Return to the mode selection menu.
- (3) **Compact display**  
View the window at a compact size. (P274)
- (4) **Minimize**  
Minimize the window to the taskbar. To view the window again, click the taskbar icon.
- (5) **Exit**  
Return to the mode selection menu.
- (6) **Projector pull-down list**  
Lists connected projectors. Your actions on this window apply to the projector selected here.

## Using the Projector in Classroom Mode

**(7) Layout area**

Lists computers selected for projection.

**(8) Projection status**

Indicates the projection status.

**(9) Computer**

A number is shown here only when secondary monitor connectivity is activated on the computer you are using. Clicking the number will switch between the primary and secondary monitor.

**(10) Blank the computer**

Pause projection from the computer. Click again to resume projection.

**(11) Settings**

Display the setting window. ([P272](#))



# Using the Projector in Broadcast Mode

In Broadcast Mode, a single computer is connected to up to 12 projectors.

⚠ Before projecting from projectors in other subnets in Broadcast Mode, you must configure the router's multicast routing settings. For details, ask your network administrator.

## Procedure

**1** In the mode selection menu, select **[Broadcast Mode]**.

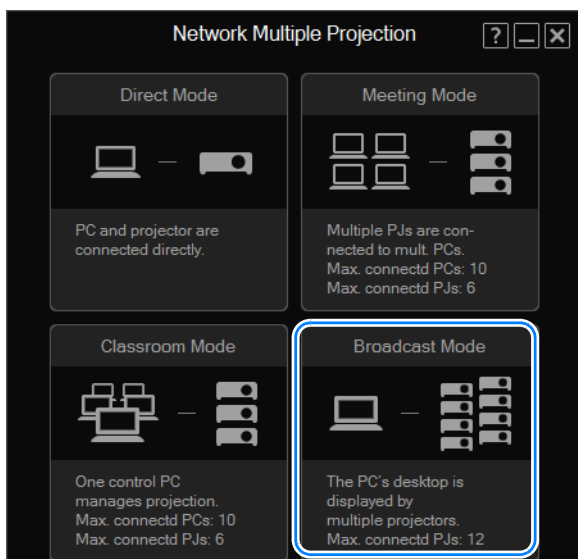

**2** The projector selection menu is displayed. In the list of projectors at left, click the projector to connect to.

You can select up to 12 projectors. Selected projectors are listed at right.

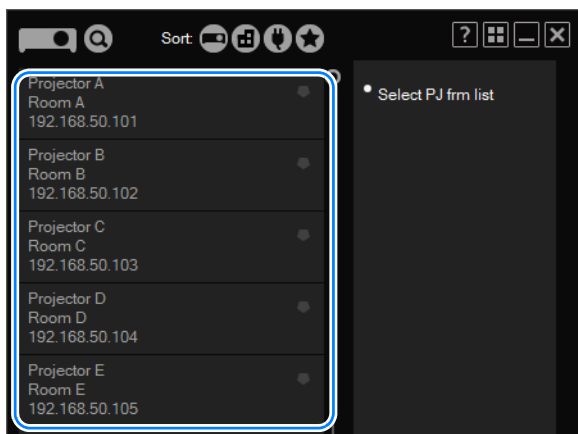

## Using the Projector in Broadcast Mode



- If the [NMPJ Password] setting has been configured on the projector's settings screen (P186), the password is now requested. Enter the password.
- To clear a selected projector, click in the upper right of that projector listing.
- For details on the projector selection menu, refer to "Using the Projector Selection Menu" (P258).

### 3 Click [Next].



### 4 The Broadcast Mode window is displayed. Click [Start projecting].

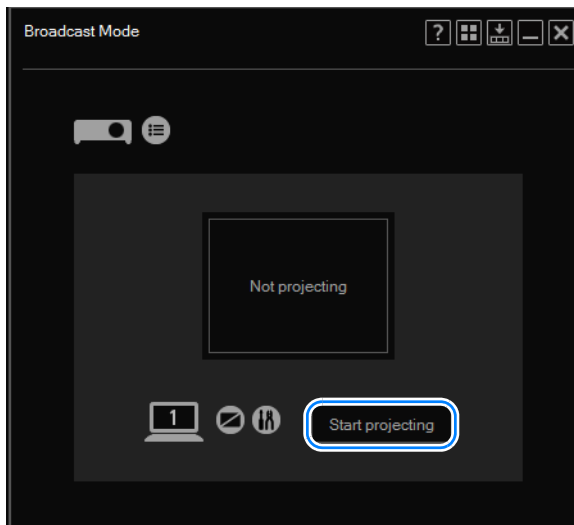

The computer screen is now projected.



To stop projection, click [Stop projecting].

5 To end the session, click  or  in the upper right.

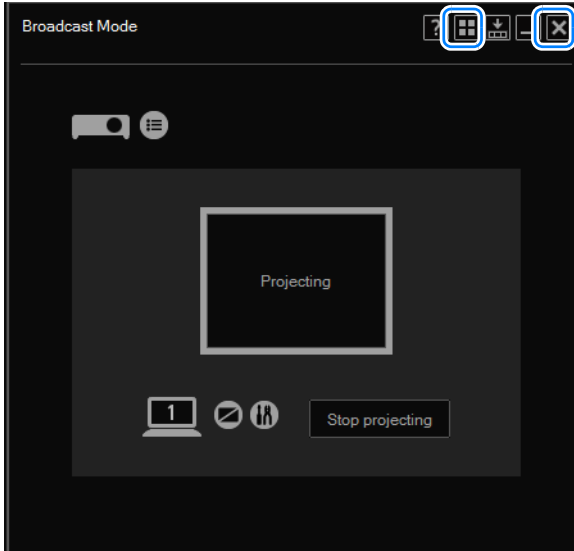

6 The following confirmation message is displayed. Click [Close].

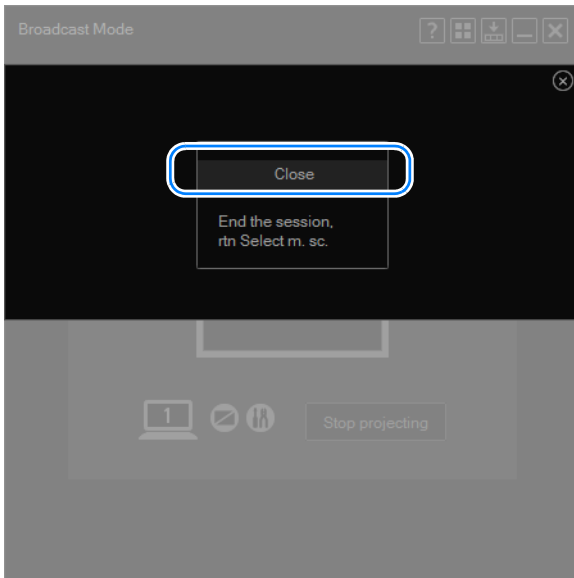

Return to the mode selection menu.

## Broadcast Mode Window

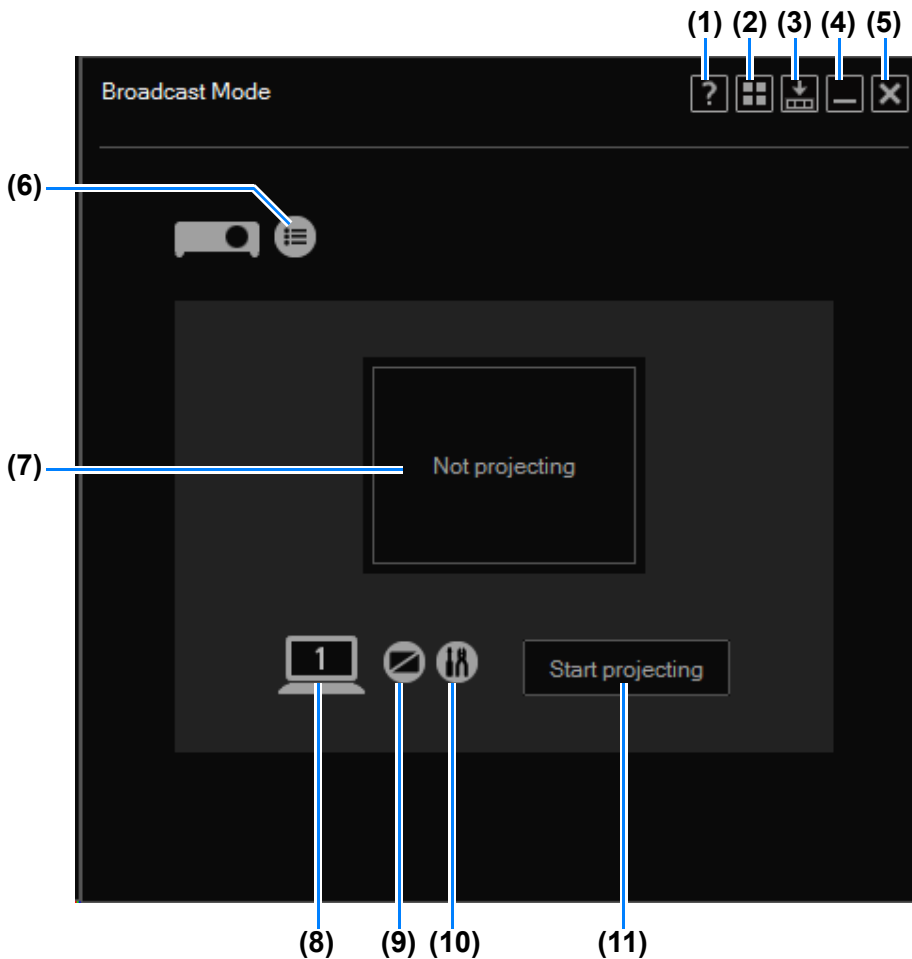

- (1) **Help**  
View application help.
- (2) **Back to mode selection**  
Return to the mode selection menu.
- (3) **Compact display**  
View the window at a compact size. (P274)
- (4) **Minimize**  
Minimize the window to the taskbar. To view the window again, click the taskbar icon.
- (5) **Exit**  
Return to the mode selection menu.
- (6) **Projector list**  
View a list of projectors.

**(7) Projection status**

Shows the projected image status.

**(8) Switch primary/secondary monitor**

A number is shown here only when secondary monitor connectivity is activated on the computer you are using. Clicking the number will switch between the primary and secondary monitor.

**(9) Blank the projector**

Pause projection. Click again to resume projection.

**(10) Settings**

Display the setting window. ([P272](#))

**(11) Start**

Start projection by the selected projector. During projection, this button is labeled [Stop projecting] and can be clicked to stop projection.



# Functions in All Modes

Table of Contents

Safety Instructions

Before Use

## Operation

Projecting an Image

Useful Functions Available During a Presentation

Setting Functions from Menus

## Installation and Maintenance

Installation

Connecting to a Network

Maintenance

## Networked Multi-Projection

Networked Multi-Projection Overview

Operation in Each Mode

Functions in All Modes

## Appendix

Other Information

Index

# Using the Session Selection Menu

## Session Selection Menu

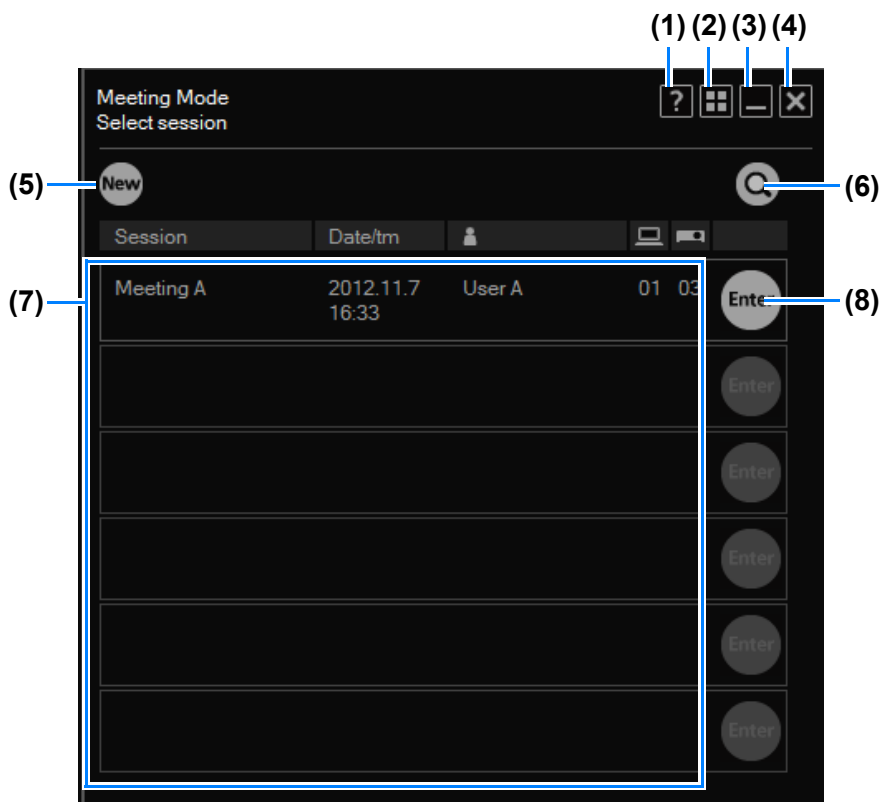

- (1) **Help**  
View application help.
- (2) **Back to mode selection**  
Return to the mode selection menu.
- (3) **Minimize**  
Minimize the window to the taskbar. To view the window again, click the taskbar icon.
- (4) **Exit**  
Return to the mode selection menu.
- (5) **[New]**  
Start a new session. (P226)
- (6) **Find session**  
Find sessions of projectors in another subnet. (P257)
- (7) **Session list**  
Lists the sessions detected. Information shown here includes the session name, creation date, creator nickname, and number of computers and projectors involved.





- (8) **[Enter]**  
Join the session. (P232)

## Finding Sessions

You can find sessions from the session selection menu.

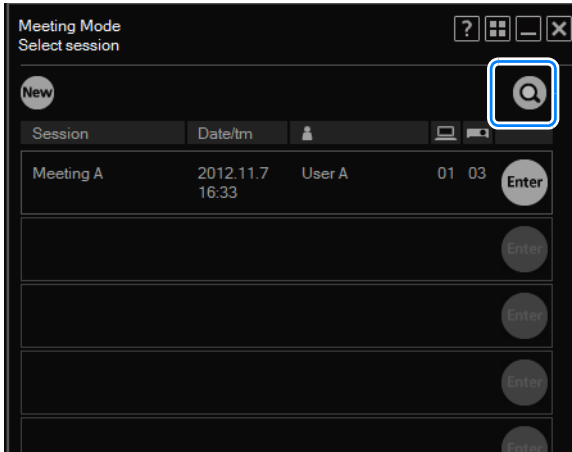
- 1** In the session selection menu, click .



- 2** The search window is displayed. Enter the IP address of a projector in the session to join, and then click  to find the projector. Once sessions are found, they are listed.

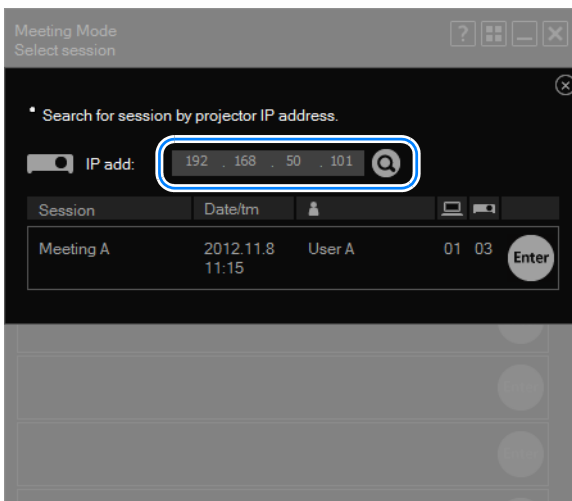

# Using the Projector Selection Menu

## Projector Selection Menu

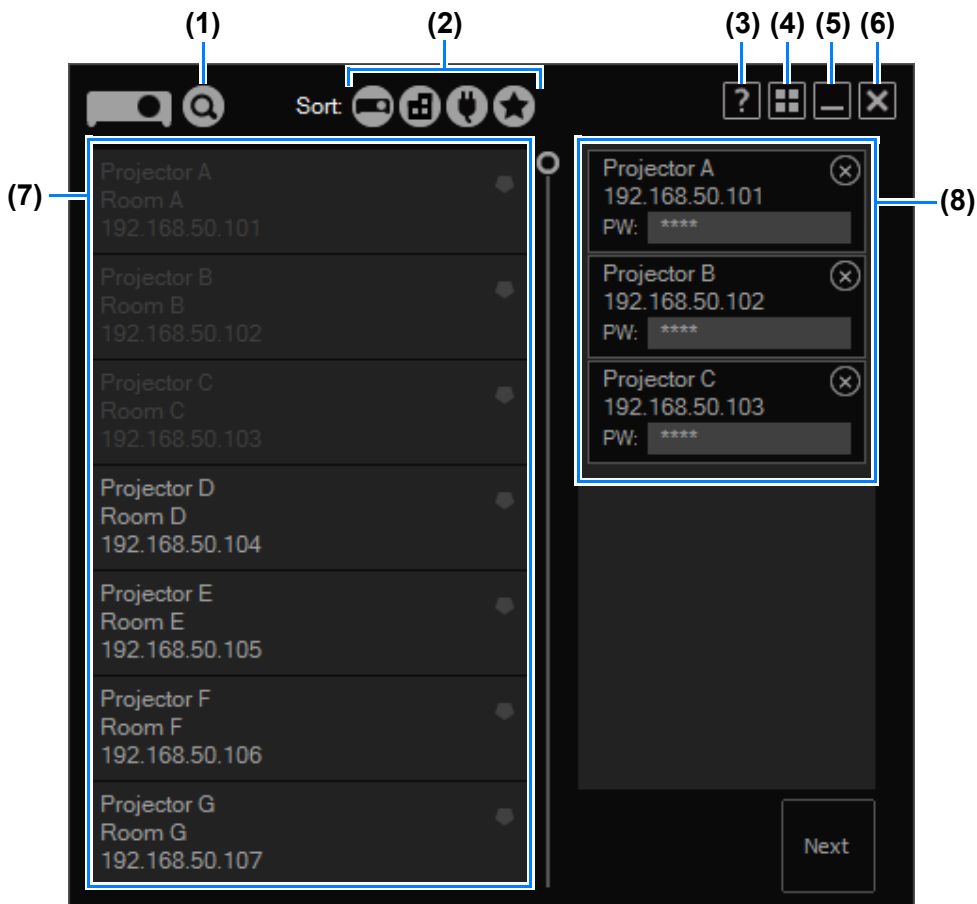

- (1) **Find projectors**  
Find projectors in another subnet. (P260)
- (2) **Sort**  
Change the sort order of the projector list. (P263)
- (3) **Help**  
View application help.
- (4) **Back to mode selection**  
Return to the mode selection menu.
- (5) **Minimize**  
Minimize the window to the taskbar. To view the window again, click the taskbar icon.
- (6) **Exit**  
Return to the mode selection menu.

**(7) Projector list**

Projectors are listed here. The information shown includes the projector names, installation location, and IP address. Available projectors are indicated by white text.

Gray text indicates that the projector is not available, whether it is off, in use by other computers, or unavailable for other reasons.

Clicking a listed projector will select it for use in the session, and it will be shown in the field at right. Selected projectors are also indicated by gray text.

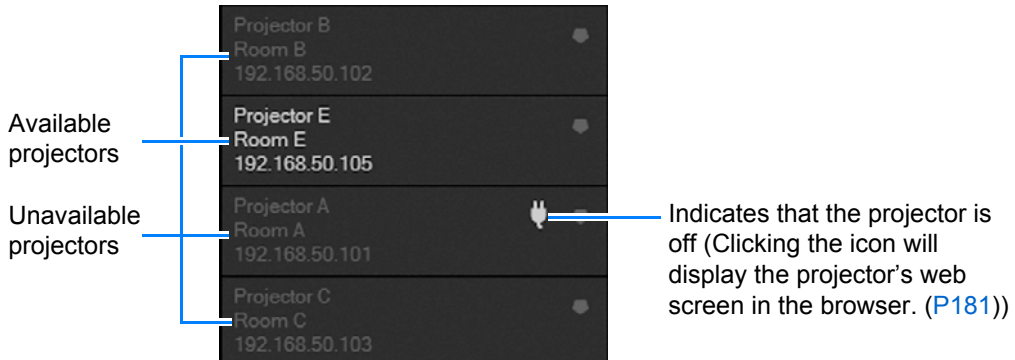
**(8) List of projectors used in the session**

Projectors selected in the list at left are shown here. To use password-protected projectors, you must enter the password in the [PW] field.

To remove projectors from this list, click .

## Using the Projector Selection Menu

### ■ Finding Projectors

To find projectors in other subnets, do the following in the projector selection menu.

- 1 In the projector selection menu, click .



- 2 The search window is displayed. Enter the projector's IP address, and then click .

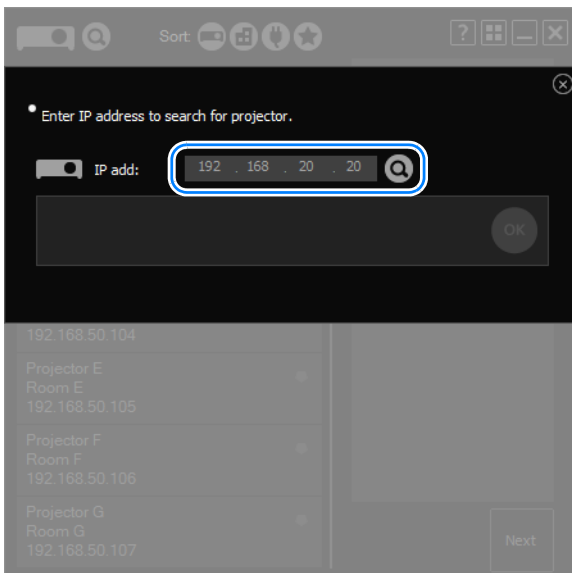

### 3 Once the projector is found, click [OK].

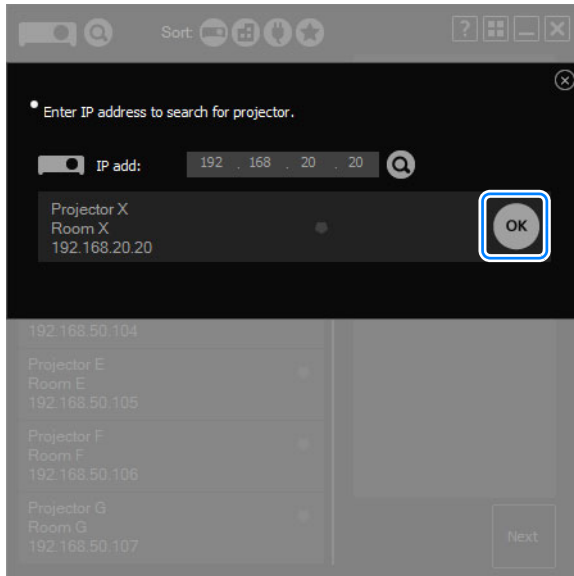

The selected projector is now added to the projector list.

### ■ Selecting Password-Protected Projectors

Selecting a password-protected projector will display a password input field. Enter the password.

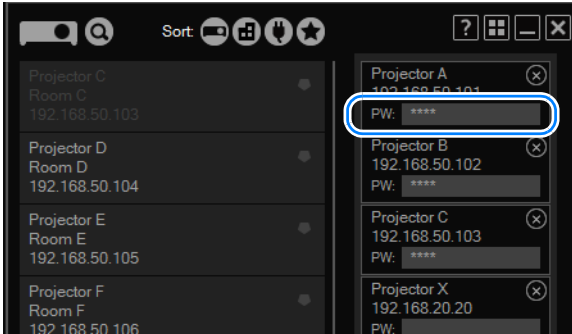

## Using the Projector Selection Menu

### ■ Using the Favorites Function

You can register commonly used projectors as favorites.

Favorite projectors are listed first when you click the  button (sort by favorites). Up to five projectors can be registered as favorites.

To register a projector as a favorite, click the Favorites icon in the projector selection menu.

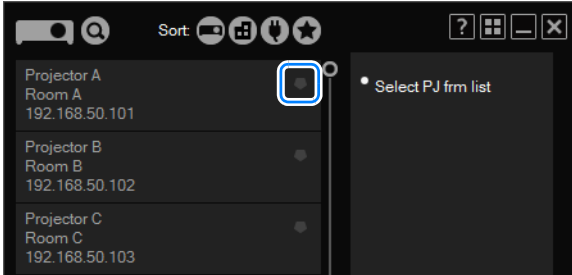



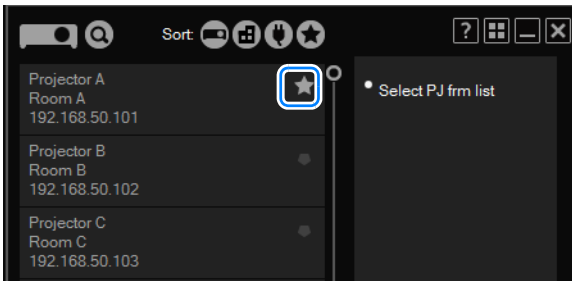

The projector is now registered as a favorite, and a star is displayed in the Favorites column.



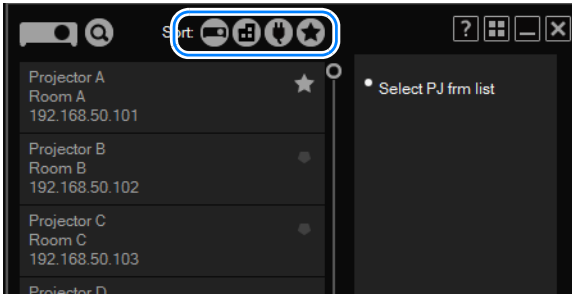

## ■ Resorting the Projector List

You can change the sort order of projector information by clicking the sort buttons.



-  List by projector name.
-  List by installation location.
-  List projectors that are currently on first.
-  List favorite projectors first.

## ■ Turning Projectors On

Projectors currently off are indicated by  in the projector selection menu. (These projectors cannot be selected for projection.) You can turn them on by clicking  to display the projector web screen and switching the power on.

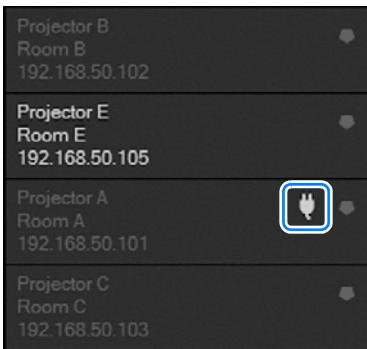

For instructions after this step, refer to “Control via the Web Screen” ([P195](#)).



Once you turn a projector on, you can select it for other operations.

# Using Layout Functions

## ■ Switching Projectors Used for the Layout

On the layout window, you can set up the projection layout.

To choose a different projector for the layout, select it from the projector pull-down list.

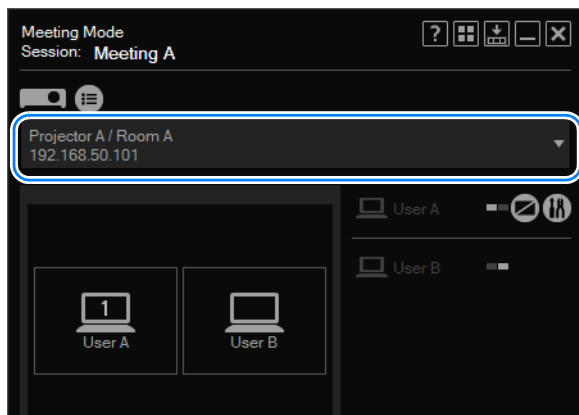

## ■ Controlling all Projectors at Once

To set up the projection layout for all projectors at once, select [ALL] in the projector pull-down menu.

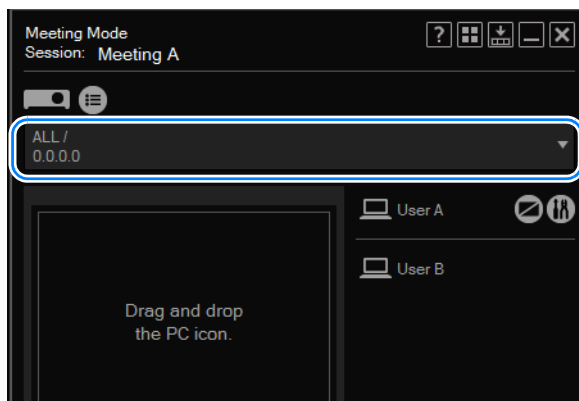



## ■ Projecting from Multiple Projectors (Multi-Projection)

In Meeting and Classroom Modes, separate images from multiple projectors can be projected together. This is called “multi-projection.” On the layout window for Meeting or Classroom Modes, you can set up the projection layout for each projector used.

### 1 On the layout window for Meeting or Classroom Modes, specify the projection layout for each projector.

In the layout area, drag the computer to use in projection, and then click [Start projecting] to start projection.

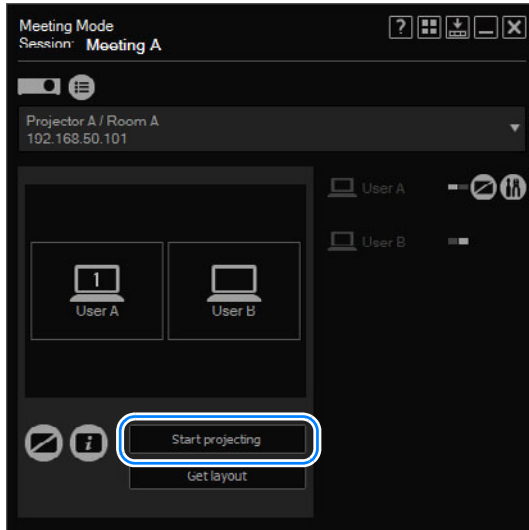

### 2 In the pull-down list, select another projector to use.

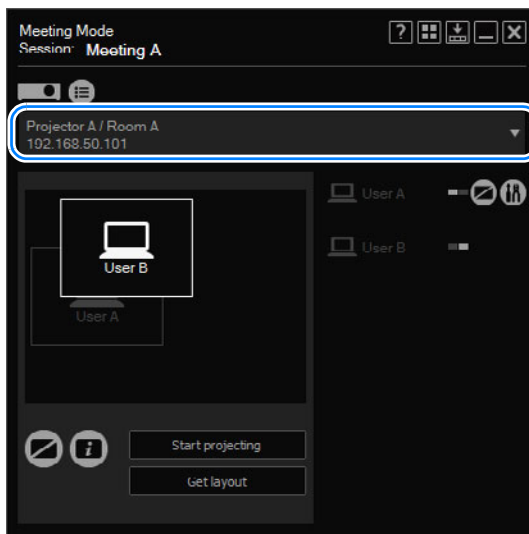

### 3 Repeat steps 1 and 2 to set up the computers to use in projection from all projectors.

### ■ Switching the Primary/Secondary Monitor

Using the application, you can switch between projection from the primary or secondary monitor.

If your computer has dual monitor support, the computer icons are labeled with numbers. The primary monitor is labeled “1,” and the secondary one, “2.”

To switch the monitor used for projection, click the icon of computers shown with a number.

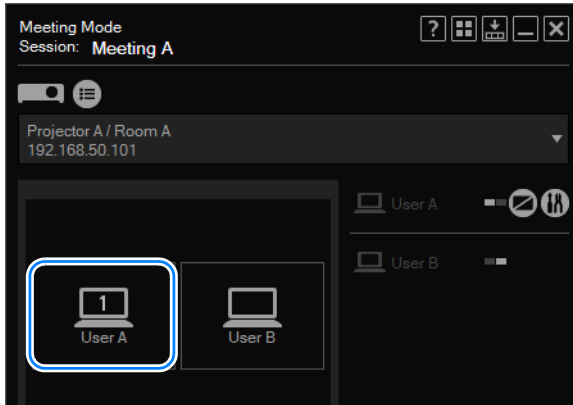



### ■ Temporarily Enlarge Images

During display from multiple computers, you can enlarge projection from one of the computers. To enlarge the display, place the cursor over the computer in the layout area, click  in the upper left, and then click [Start projecting]. The image from the selected computer is now projected in full-screen mode.

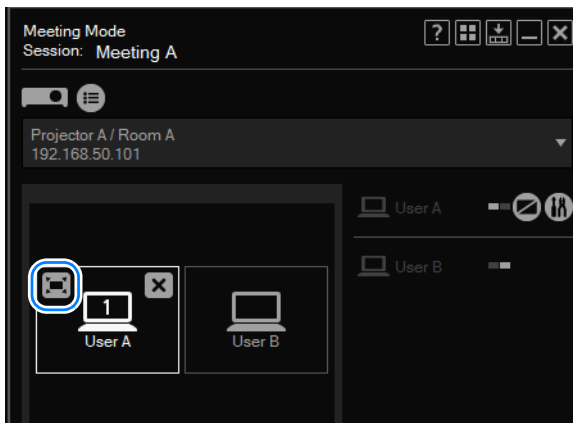
To cancel the enlarged display, place the cursor over the computer in the layout area again. Click  in the upper left, and then click [Start projecting].



## ■ Projecting Session Information

You can project session information needed by other users to join a session, such as the session name and projector IP address. To project session information, click . To cancel display, click  again.

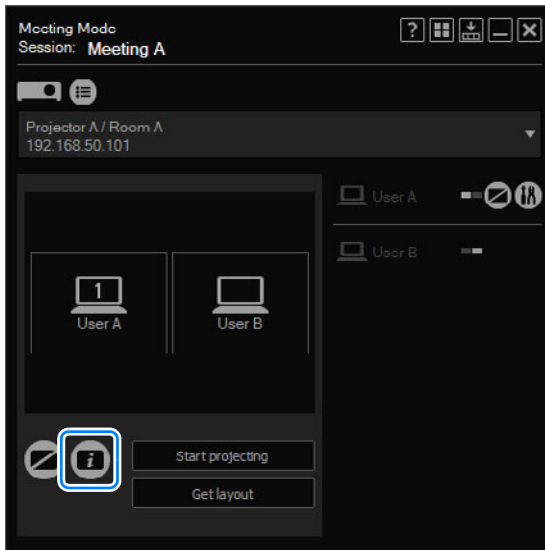

## ■ Fully Blanking Projection

Blanking refers to temporarily stopping projection from computers, so that no image is projected. To blank projection, click . To cancel blanking and return to normal projection, click  again.

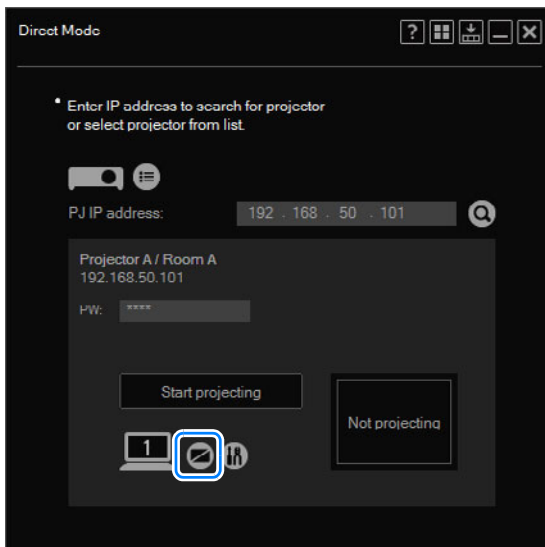

Direct Mode window

## Using Layout Functions

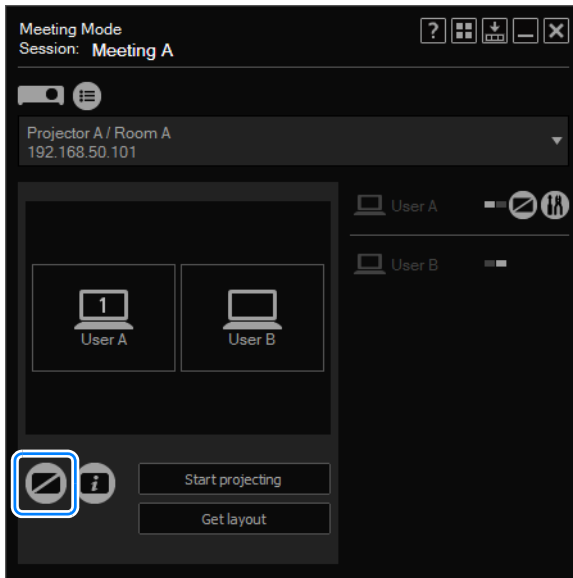

Meeting Mode window

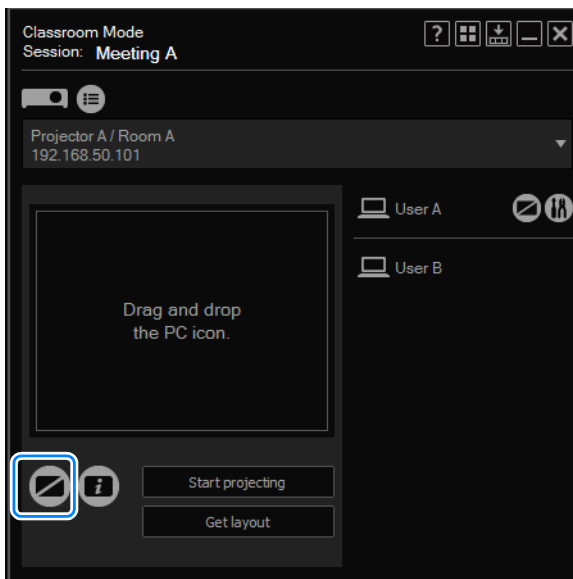

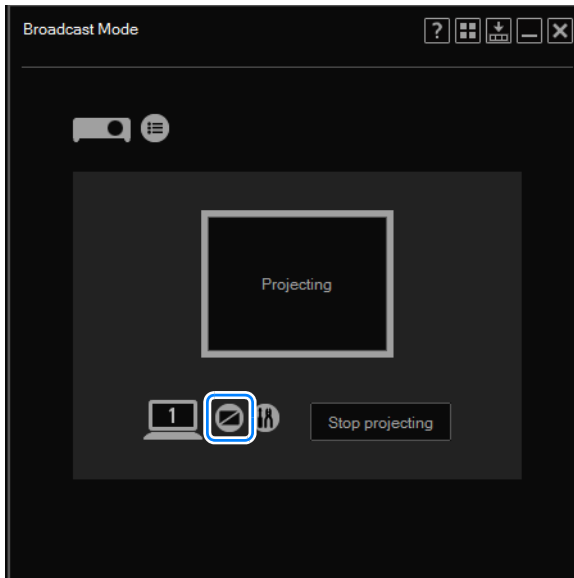

Classroom Mode window (starting a session)



Broadcast Mode window

## ■ Blanking Projection from Your Computer

In Meeting and Classroom Modes, you can blank projection your computer alone. To blank projection from your computer, click  in the computer list. To cancel blanking and return to normal projection, click  again.

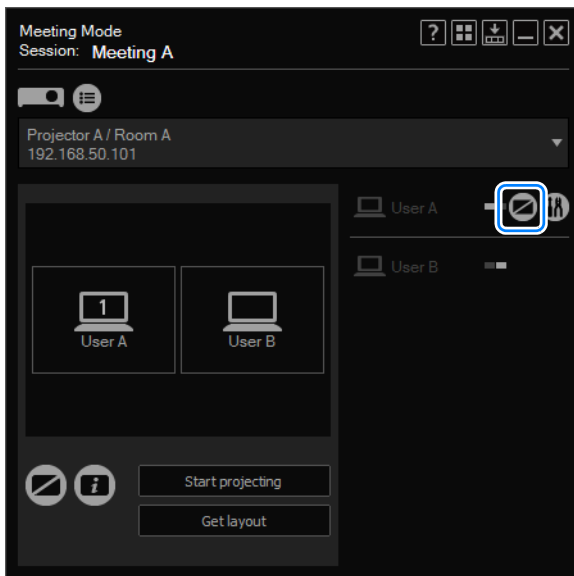

Meeting Mode window

## Using Layout Functions



Classroom Mode window (joining a session)

### ■ Checking for Computers That Join or Leave Sessions

In Meeting and Classroom Modes, computer users can join or leave sessions as needed. Computers joining a session are added to the computers listed on the layout window.

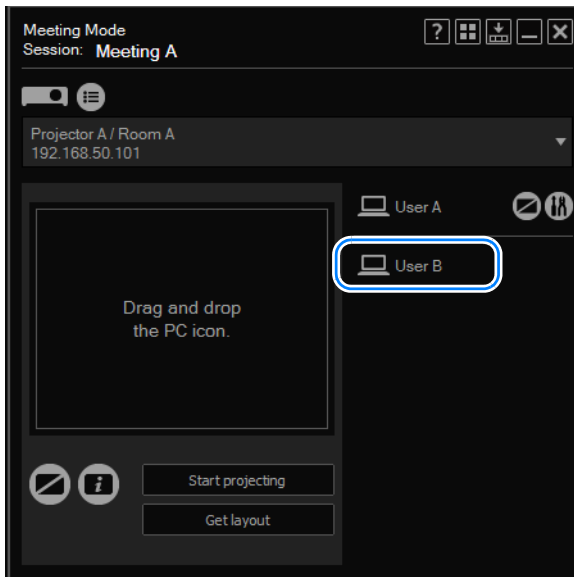

Similarly, computers leaving a session are removed from the list of computers.

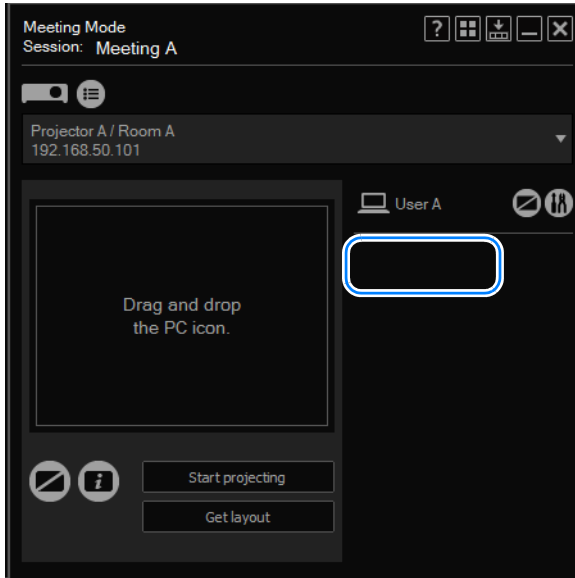

# Completing Application Projection Settings

Application settings can be configured to specify the image quality of computer projection, user nicknames, and other details.

- 1 Click  next to the computer icon.

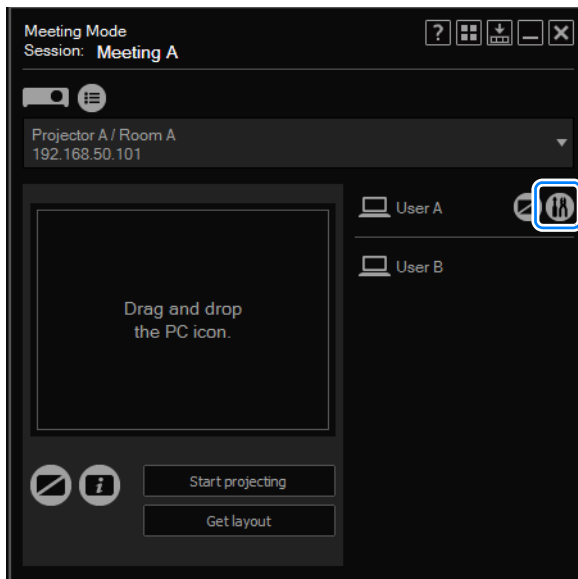

- 2 The settings window is displayed. Complete each setting as needed, and then click [OK].

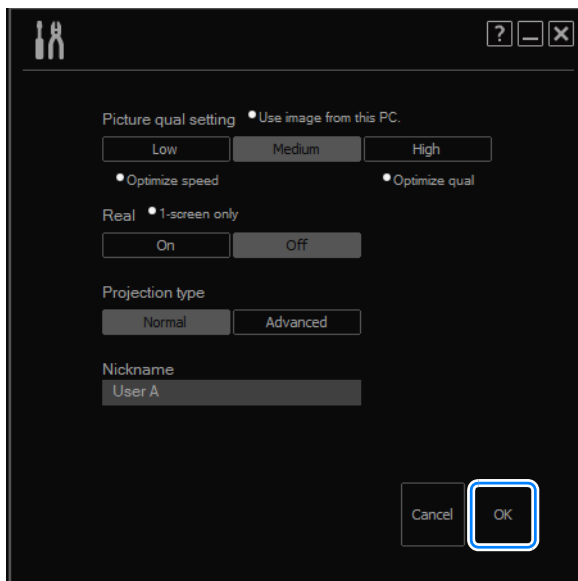

Available settings are as follows. (Types of settings vary slightly by mode.)



When setting windows are displayed while layout windows are minimized to the taskbar, some information may be cut off.



<b>Picture qual setting</b>	<p>Select one of the following options, depending on your preferred image quality and frame rate.</p> <p>High : Projects at a lower frame rate while emphasizing image quality. Select this mode if lower image quality is not acceptable.</p> <p>Medium : Projection with image quality and frame rate balanced.</p> <p>Low : Projects at lower image quality to maintain a high frame rate. Select this mode to reduce the network bandwidth used for projection.</p>
<b>Real</b>	<p>On : Projection matching the computer display resolution. Available under the following conditions.</p> <p>When projecting from a single computer—or during projection from multiple computers, when projecting an enlarged image from one computer—at a display resolution lower than the projector resolution.</p> <p>Off : Automatically adjust the projection size to match the projector screen size.</p>
<b>Projection type</b>	<p>Normal : Although some windows cannot be projected, the cursor on the computer monitor will not flash.</p> <p>Advanced : Most windows can be projected, but the cursor on the computer monitor will flash. (Only the cursor on the computer monitor will flash, not the cursor in projected images.)</p>
<b>Nickname</b>	<p>Nickname specified when creating or joining sessions. Cannot be changed during sessions. This option is not shown in Direct or Broadcast Modes.</p>
<b>Multicast address</b>	<p>The multicast address used in Broadcast Mode can be changed. Use this setting to change the multicast address if it conflicts with that of other network equipment. This option is only shown in Broadcast Mode.</p>

# Reducing Windows to a Compact Size

A compact version of windows in all modes is available, showing only the minimum buttons and information needed.

1 Click .

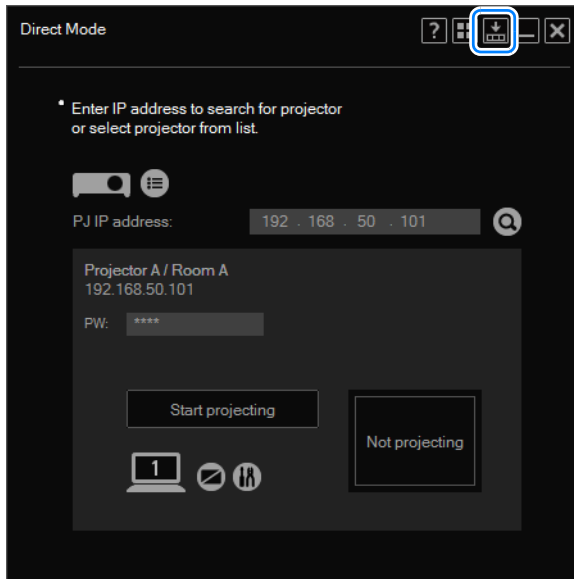

The window is now reduced to a compact size.

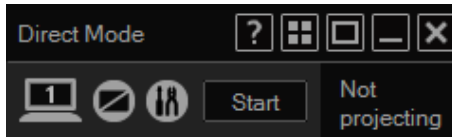

The title bar is no longer displayed when the cursor is away from the window, which makes the window even more compact.

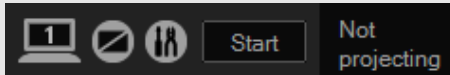

2 To revert to original size, click .

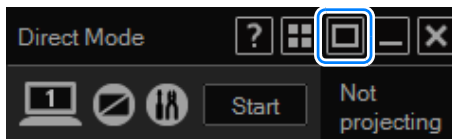

# Tips for Better Networked Projection

## ■ Avoid Exceeding Connection Limits

The maximum number of computers and projectors that can be connected varies by mode. When this limit would be exceeded, it is not possible to add computers or projectors to a session. Thus, if the total number of computer users requesting to join a session at the same time would exceed the limit, their requests may be denied. In this case, an error message is displayed on the computers that could not join the session.

Similarly, if the total number of projectors users attempt to add to a session at the same time would exceed the limit, their requests may be denied. In this case, a message is displayed on computers that could not add projectors, indicating that the projector list has been updated.

## ■ Operation if Devices Are Disconnected

If the connection is lost (for example, if a LAN cable is accidentally disconnected), the affected computer or projector leaves the session. Disconnection of essential computers or projectors will terminate a session.

For example, in Classroom Mode, disconnection of the presenter's computer will terminate the session.

## ■ If Projectors Cannot Be Detected

If projectors cannot be detected or no image is displayed (except for the cursor) when you are attempting to connect to projectors in other subnets in Broadcast Mode, make sure the router supports multicast routing. Routers that do not support IPv4 multicast routing cannot be used to connect to projectors in other subnets in Broadcast Mode. Note that the router must be set up to route multicast addresses used by the application.



In Broadcast Mode, the following message is displayed if no signal is received from computers for 30 seconds. The projector IP address and name are shown in the upper left.

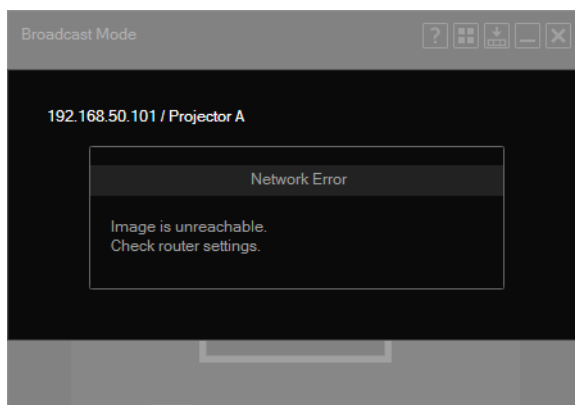

# Restrictions

## ■ Router Connections

Although the application can also link computers and projectors over a network via a router, operation is only ensured over one router hop. Note that before projecting from projectors in other subnets in Broadcast Mode, you must configure the router's multicast routing settings. For details, ask your network administrator.

## ■ Security Dialog Box Projection

The application cannot be used to project the Windows Security dialog box, normally accessed by pressing Ctrl+Alt+Del.

## ■ Screen Capture Software

It may not be possible to start the application while software that restricts screen captures is running.

## ■ Animated Cursors

Animation of animated cursors is not projected.

## ■ Alternative Cursors

Cursors used by some software may not be projected correctly. In this case, an arrow pointer is projected.

## ■ Projection Restrictions

Some windows and icons displayed on computers cannot be projected. Although switching the projection type to advanced will enable projection of more elements, not all elements can be projected even in this case.

Projected images may not always match the computer screens.

## ■ Network Bandwidth

Some network conditions may cause a delay in projection.

## ■ Projection through Firewalls

Some application functions may not be available in environments where Windows Firewall or other software restricting network communication are installed.

## ■ Application Display

Application display may be distorted if you have adjusted the screen resolution in Windows.

MULTIMEDIA PROJECTOR

**WUX450**

**WX520**

**WUX400ST**

**WX450ST**

# Appendix





# Appendix

---

Table of Contents

---

Safety Instructions

---

Before Use

**Operation**

---

Projecting an Image

---

Useful Functions Available  
During a Presentation

---

Setting Functions from  
Menus

**Installation and Maintenance**

---

Installation

---

Connecting to a Network

---

Maintenance

**Networked Multi-Projection**

---

Networked Multi-Projection  
Overview

---

Operation in Each Mode

---

Functions in All Modes

**Appendix**

---

Other Information

---

Index

## LED Indicator Meanings

When there is a problem with the projector, the LED indicator on the side of the projector illuminates or flashes continuously after the projector is turned off.

- Wait until the cooling fan stops and disconnect the power plug from the electrical outlet before dealing with the problem.

LED indicator status	Meaning	Countermeasure
WARNING and TEMP are lit.	Temperature abnormality	The temperature inside the projector is too high for some reason or the outside air temperature is higher than the operating range. If the problem is inside the projector, check whether the projector is installed and operating normally, unplug the projector from the power outlet to cool down the projector interior and then restart projection. If the air intake or exhaust vent is blocked, remove the obstacle. If the same warning occurs again, there may be a malfunction in the projector. Contact the Canon Customer Support Center.
WARNING and LAMP are lit.	Faulty lamp	The lamp does not illuminate. Turn the power off and then back on and check whether or not the lamp illuminates. Also, check whether the air intake or exhaust vent is blocked, and whether the air filter is clogged with dust. The warning may indicate if the air flow in and out of the projector is blocked, or if the internal temperature of the projector rises. If the air filter is clogged, clean or replace the air filter. (P199, P200) If the lamp does not illuminate, replace it. If the same warning occurs again, there may be a malfunction in the lamp drive circuit. Contact the Canon Customer Support Center.
WARNING flashes 3 times, LAMP is lit.	Faulty lamp cover	The lamp cover is open. Unplug the projector from the power outlet, then install the lamp cover correctly and turn on the projector again. If the lamp cover has been installed properly, there may be a malfunction in the lamp cover detection switch. Contact the Canon Customer Support Center.
WARNING (only) flashes 4 times repeatedly.	Faulty cooling fan	There may be a malfunction in the cooling fan or another component. Unplug the projector from the electrical outlet, then plug it back into the outlet and turn on the projector again. Contact the Canon Customer Support Center if the same warning occurs again.



LED indicator status	Meaning	Countermeasure
WARNING (only) flashes 5 times repeatedly.	Faulty power supply	Abnormal voltage is applied to some parts in the power supply or another failure may have occurred. Unplug the projector from the electrical outlet, then plug it back into the outlet and turn on the projector again. Contact the Canon Customer Support Center if the same warning occurs again.
WARNING (only) flashes 3 times repeatedly.	Filter error	The air filter is not installed. Check whether or not the air filter is installed correctly. Contact the Canon Customer Support Center if the same warning occurs again.

## Symptoms and Solutions

### ■ You Cannot Turn on the Projector

Cause	Countermeasure
The power cord is not connected correctly.	Check whether the power cord is connected correctly. (P143)
The power cord has just been connected.	Wait at least one second after plugging the projector in until you press the <b>POWER</b> button. You cannot turn the projector on immediately after plugging it in. (P52)
The lamp cover is open.	Unplug the projector from the power outlet, then install the lamp cover correctly and turn on the projector again.
The safety device is activated because the air intake or the exhaust vent is blocked and the internal temperature of the projector has increased.	When the safety device is active, the [POWER ON] indicator does not turn on when you connect the power cord. You cannot disable this safety device. Remove any obstacle that is blocking the air intake or exhaust vent and contact the Canon Customer Support Center.
The air filter is not installed correctly.	Check whether the air filter is installed correctly. (P199)
Key lock is enabled.	Check that Key lock (P112) is not enabled for the projector or the remote control.

## ■ You Cannot Project an Image from the Projector

Cause	Countermeasure
A cable is not connected correctly.	Check whether the projector is connected to the computer or AV equipment correctly. (P137, P140)
20 seconds have not elapsed since the projector was turned on.	When the projector is turned on, the opening window is displayed for approximately 20 seconds. To project an image immediately, press the <b>OK</b> button on the remote control or side control. (P52)
No image is sent from the AV equipment.	Check whether an image is played on the connected video camcorder, DVD, etc.
Connection with the input terminal has not been performed correctly.	Check whether the AV equipment is connected to the projector input terminal correctly. (P136)
No input signal type has been selected for the connected AV equipment.	Check that the same input signal has been correctly selected for the connected AV equipment from the [INPUT] menu. (P54)
The input signal type is incorrect.	Check whether the selected input signal type is correct. (P88, P292)
The BLANK function has been selected.	Press the <b>BLANK</b> button on the remote control. (P76)
No image is projected due to a problem with the computer.	Turn first the projector and then the computer off and then back on again.
The external monitor output is not set on the notebook computer correctly.	<p>Turn on the external monitor output on the notebook computer. To turn on the external monitor output, press the [LCD] or [VGA] function key or a key with an icon for the external monitor, while holding down the [Fn] key on the keyboard of the notebook computer. With Windows 7, you can turn on image output by holding down the Windows logo key and pressing the [P] key. (P145)</p> <p>The combination of keys used to perform this operation varies depending on the model of notebook computer. For more detailed information, refer to the manual that came with your computer.</p>
The displayed image is not the same as that displayed on the computer.	<p>Check whether the dual screen (multi-display) mode is selected on the computer. If dual screen mode is selected, change the computer display output to mirroring mode.</p> <p>The output setting method varies among computer manufacturers. For more detailed information, refer to the manual that came with your computer.</p>

Cause	Countermeasure
Images on a USB flash drive cannot be projected.	Projection from USB flash drives requires JPEG images with a resolution not exceeding 7000x7000, single-byte alphanumeric file names, and a FAT-formatted drive.
Split-screen display is not available.	Split-screen display is not available when projecting images from USB flash drives or over a network.
The LAN cable (shielded twisted pair) is not connected correctly.	Check whether the LAN cable (shielded twisted pair) is connected to the projector correctly. (P168)
A network connection cannot be established.	Network connections are not available until about 40 seconds after startup. (P181)

## ■ There is no Sound

Cause	Countermeasure
The audio cable is not connected correctly.	Check the audio cable connection. (P136)
The MUTE function is enabled.	Press the <b>MUTE</b> button on the remote control. (P77)
The volume level is adjusted to the minimum.	Press the <b>VOL</b> button on the remote control or the <b>VOL+</b> button on the side control to adjust the volume level. (P77)
An audio cable with a built-in resistor is used.	Use an audio cable without a built-in resistor.
Audio in terminal select is [Off].	Change the Audio In terminal to the appropriate setting. (P153)

## ■ The Projected Image Is Blurred

Cause	Countermeasure
The image is out of focus.	Adjust the focus. (P59)
The distance to the screen is too short.	Check whether the distance to the screen is appropriate.
The projector is not placed straight in front of the screen.	Check whether the projector is placed obliquely to the screen. A slight error in the projection angle can be corrected through the keystone adjustment function. (P68)
The projector has been moved to a place where the temperature varies a lot.	When the projector is moved from a location where the temperature is low to a location where the temperature is high, condensation may form on the lens. The condensation will evaporate after a period of time and the projector will be able to project a normal image.
The lens is stained.	Clean the lens. (P198)
The tracking is bad.	Adjust the tracking with the [Auto PC] or [Tracking] function. (P57, P89)
Video is blurred.	Activate motion blur reduction. (P114)
Motion blur reduction is not available.	Motion blur reduction is not available when projecting JPEG files from USB flash drives or over a network, or for networked multi-projection. Similarly, motion blur reduction is not available in image modes other than [Presentation] or [Dynamic].
The sharpness setting is not available.	Sharpness cannot be adjusted during split-screen display.

## ■ You Cannot Project an Image Appropriately

Cause	Countermeasure
The projected image is inverted in the vertical or horizontal direction.	The ceiling mounted / rear projection setting is incorrect. Check the [Image flip H/V] setting in the [Install settings] menu. (P146)
The dot clock of the input signal is higher than 162 MHz with a BNC cable.	Set the signal dot clock to 162 MHz or less on your computer.
A computer cable is used in which some pins are not connected.	Use a computer cable in which all pins are connected.

## ■ The Projector Power Turns Off

Cause	Countermeasure
The air intake or exhaust vent is blocked.	Check whether the air intake or exhaust vent is blocked. If the air intake or exhaust vent is blocked, the temperature inside the projector will increase and the power is automatically turned off to protect the projector. (The [WARNING] indicator and [TEMP] indicator are lit.) Wait until the projector temperature drops, then make sure that the intake and exhaust vents are not blocked and turn on the projector. (P37, P52)
The air filter is dirty.	Check whether the air filter is clogged with dust. If the air filter is clogged, clean or replace the air filter. (P199)
The lamp has broken (or there is a lamp malfunction).	Check whether the lamp has broken. If the lamp has broken, follow the instructions on page 26. If the lamp has not broken, there may be a malfunction with the lamp. Check the lamp by replacing it with a spare lamp if you have one. (P27, P201, P202)
The operating temperature is inappropriate.	Check whether the operating temperature is between 0°C (32°F) and 40°C (104°F). (P29) Projector settings must be adjusted when using the projector at altitudes of 2,300 m (7,545.8') or higher. Set [Fan mode] in the [Install settings] menu to [High altitude] (P152).

## ■ You Cannot Operate the Remote Control

Cause	Countermeasure
Batteries are not installed properly or they have run out.	Check whether batteries are installed correctly. If batteries are installed correctly, replace them with new batteries. (P34)
You are operating the remote control from the outside of the remote control operating range.	Check whether you are operating the remote control within the remote control operating range of the main unit of the projector. (P35)
There is an obstacle between the projector and the remote control.	Remove the obstacle between the infrared remote receiver of the main unit of the projector and the remote control or point the remote control in an obstacle-free path.
You are operating the remote control in an unsuitable operating environment.	Check whether the infrared remote receiver of the main unit of the projector is exposed to direct sunlight or strong light of lighting apparatus. (P35)
The channel setting of the remote control does not match the setting of the projector.	Check whether the channel setting of the remote control has been changed. You can check the [Remote control channel] setting in the [System settings] menu. (P113)
The key lock function is preventing operation of the remote control.	Check whether [Key lock] is enabled to disable the remote control operation. In the [System settings] menu, set [Key lock] to [Off]. (P112)

## ■ You Cannot Control Networked Multi-Projection

Cause	Countermeasure
The application cannot be installed.	Confirm that the monitor resolution is at least 1024x768. Check the system requirements (P210).

If the above causes cannot be identified, the projector may be damaged. Contact the Canon Customer Support Center as soon as possible.



Administrator privileges are required when installing NMPJ from the universal installer. The following message is displayed when you are logged in as a regular user: "Installation program of Network Multi Projection requires administrator privileges."

# Relationship between Aspect and Screen Aspect

This section describes the relationship between screen aspect (P60) and aspect (P66).

Select an optimum aspect ratio of the projected image (screen aspect) or an optimum screen mode (aspect) according to the aspect ratio of the screen, type of input image signal and so on for the projection to make best use of the screen size.

- If a computer image with an aspect ratio of 16:9 is not projected correctly when the setting is [Auto], select [16:9] as the screen aspect.
- For a 16:9 image with black borders at the top and bottom, such as a terrestrial broadcast movie, you can project the 16:9 image area so that it is projected on the entire screen by selecting [Zoom] in [Aspect].

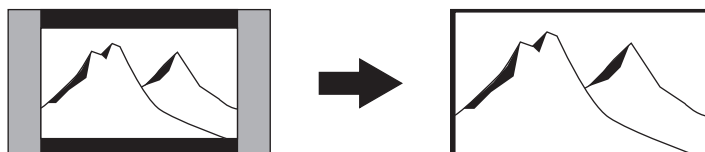

There may be some cases that [Zoom] cannot be selected depending on the input signal and/or resolution.

- For keystone correction (P68), select an option other than [4:3 D. image shift] or [16:9 D. image shift] for [Screen aspect].



## ■ When the image is projected on a 16:10 screen

Aspect ratio of connected device	Screen aspect setting (P60)	Aspect setting (P66)	Screen image
(16:10) 1920 x 1200 1440 x 900 1280 x 800	[16:10]	[16:10] [Auto]	
(16:9) 1920 x 1080 1280 x 720		[16:10]	
(4:3) 1600 x 1200 1400 x 1050 640 x 480		[16:10]	

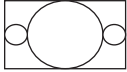
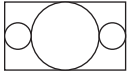
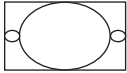
## ■ When the image is projected on a 16:9 screen

Aspect ratio of connected device	Screen aspect setting (P60)	Aspect setting (P66)	Screen image
(16:10) 1920 x 1200 1440 x 900 1280 x 800	[16:9] [16:9] D. image shift]	[16:9]	
(16:9) 1920 x 1080 1280 x 720		[16:9] [Auto]	
(4:3) 1600 x 1200 1400 x 1050 640 x 480		[16:9]	

## ■ When the image is projected on a 4:3 screen

Aspect ratio of connected device	Screen aspect setting (P60)	Aspect setting (P66)	Screen image
(16:10) 1920 x 1200 1440 x 900 1280 x 800	[4:3] [4:3] D. image shift]	[4:3]	
(16:9) 1920 x 1080 1280 x 720		[4:3]	
(4:3) 1600 x 1200 1400 x 1050 640 x 480		[4:3] [Auto]	

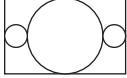
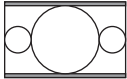
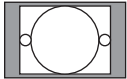

■ When projecting on a 16:10 screen in the aspect ratio of the connected device

Aspect ratio of connected device	Screen aspect setting (P60)	Aspect setting (P66)	Screen image
(16:10) 1920 x 1200 1440 x 900 1280 x 800	[16:10]	[16:10] [Auto]	
(16:9) 1920 x 1080 1280 x 720		[16:9] [Auto]	
(4:3) 1600 x 1200 1400 x 1050 640 x 480		[4:3] [Auto]	

■ When projecting on a 16:9 screen in the aspect ratio of the connected device

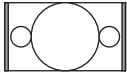
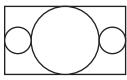
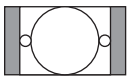
Aspect ratio of connected device	Screen aspect setting (P60)	Aspect setting (P66)	Screen image
(16:10) 1920 x 1200 1440 x 900 1280 x 800	[16:9] [16:9 D. image shift]	[Auto]	
(16:9) 1920 x 1080 1280 x 720		[16:9] [Auto]	
(4:3) 1600 x 1200 1400 x 1050 640 x 480		[4:3] [Auto]	

## ■ When projecting on a 4:3 screen in the aspect ratio of the connected device

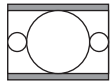
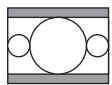
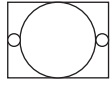
Aspect ratio of connected device	Screen aspect setting (P60)	Aspect setting (P66)	Screen image
(16:10) 1920 x 1200 1440 x 900 1280 x 800	[4:3] [4:3 D. image shift]	[Auto]	
(16:9) 1920 x 1080 1280 x 720		[16:9] [Auto]	
(4:3) 1600 x 1200 1400 x 1050 640 x 480		[4:3] [Auto]	

# Displayed Test Patterns

The test pattern can be displayed by pressing the **TEST PATTERN** button. Use this when there is no image signal, etc.

While the test pattern is displayed, you can use the [▲] / [▼] buttons to change to a different test pattern. Also, if there is an option pattern available, you can use the [◀] / [▶] buttons to switch pattern. A dialog box is shown during test pattern display that identifies the current test pattern and provides operating instructions.

The following test patterns can be displayed.

Use [▲] / [▼] to switch patterns

Use [◀] / [▶] to switch option patterns

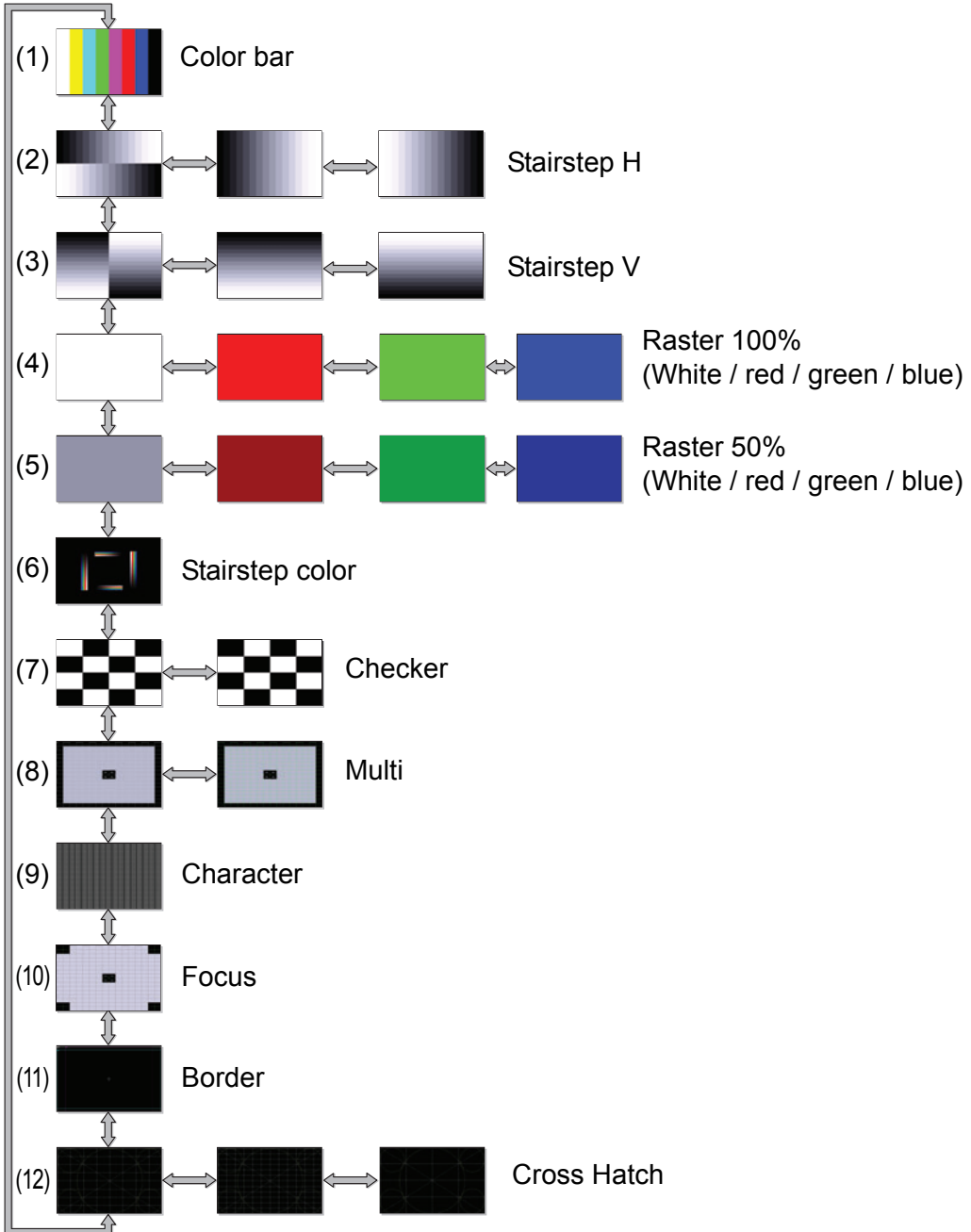

# Supported Signal Types

This projector supports the following signal types.

If your computer or AV equipment is compatible with any one of these signal types, the projector's Auto PC function selects the input signal type to project an image appropriately.

## Analog PC

Resolution (dots)	Signal type	Horizontal frequency (kHz)	Vertical frequency (Hz)	
640 x 480	VGA	31.469	59.940	
720 x 480	–	31.469	59.940	
720 x 576	–	31.250	50.000	
800 x 600	SVGA	37.879	60.317	
848 x 480	–	31.020	60.000	
1024 x 768	XGA	48.363	60.004	
1280 x 720	–	45.000* <sup>1</sup>	60.000* <sup>1</sup>	
1280 x 768	WXGA	47.776	59.870	
		47.396	59.995	
1280 x 800		49.702	59.810	
49.306		59.910		
1280 x 960		–	60.000	60.000
1280 x 1024		SXGA	63.981	60.020
1366 x 768	–	47.712	59.790	
1400 x 1050	SXGA+	64.744	59.948	
		65.317	59.978	
1440 x 900	WXGA+	55.935	59.887	
		55.469	59.901	
1600 x 900	–	60.000	60.000	
1600 x 1200	UXGA	75.000	60.000	
1680 x 1050	WSXGA+	64.674	59.883	
		65.290	59.954	
1920 x 1080	–	56.250	50.000	
		67.500	60.000	
1920 x 1200	WUXGA	74.038* <sup>2</sup>	59.950* <sup>2</sup>	

## Digital PC

Resolution (dots)	Signal type	Horizontal frequency (kHz)	Vertical frequency (Hz)
640 x 480	D-VGA	31.469	59.940
720 x 480	–	31.469	59.940
720 x 576	–	31.250	50.000
800 x 600	D-SVGA	37.879	60.317
1024 x 768	D-XGA	48.363	60.004
1280 x 720	–	37.500	50.000
		45.000	60.000
1280 x 800	D-WXGA	49.702	59.810
		49.306	59.910
1280 x 1024	D-SXGA	63.981	60.020
1366 x 768	–	47.712	59.790
1400 x 1050	D-SXGA+	64.744	59.948
		65.317	59.978
1440 x 900	D-WXGA+	55.935	59.887
		55.469	59.901
1600 x 900	–	60.000	60.000
1600 x 1200	D-UXGA	75.000	60.000
1680 x 1050	D-WSXGA+	64.674	59.883
		65.290	59.954
1920 x 1080	–	27.000	24.000
		56.250	50.000
		67.500	60.000

Resolution (dots)	Signal type	Horizontal frequency (kHz)	Vertical frequency (Hz)
1080PsF (1920 x 1080i)	-	27.000	24.000
		28.125	25.000
		33.750	30.000
1920 x 1200	D-WUXGA	74.038*2	59.950*2

## HDMI

### Connecting to a computer

Resolution (dots)	Signal type	Horizontal frequency (kHz)	Vertical frequency (Hz)
640 x 480	VGA	31.469	59.940
800 x 600	SVGA	37.879	60.317
1024 x 768	XGA	48.363	60.004
1280 x 800	WXGA	49.702	59.810
		49.306	59.910
1280 x 1024	SXGA	63.981	60.020
1366 x 768	-	47.712	59.790
1400 x 1050	SXGA+	64.744	59.948
		65.317	59.978
1440 x 900	WXGA+	55.935	59.887
		55.469	59.901
1600 x 900	-	60.000	60.000
1600 x 1200	UXGA	75.000	60.000
1680 x 1050	WSXGA+	64.674	59.883
		65.290	59.954
1920 x 1200	WUXGA	74.038*2	59.950*2

### Connecting with AV equipment

Signal type	Horizontal frequency (kHz)	Vertical frequency (Hz)
480p	31.469	59.940
576p	31.250	50.000
720p	37.500	50.000
	45.000	60.000
1080i	28.125	50.000
	33.750	60.000
1080p	27.000	24.000
	56.250	50.000
	67.500	60.000

## Component

Signal type	Horizontal frequency (kHz)	Vertical frequency (Hz)
480i	15.734	59.940
480p	31.469	59.940
576i	15.625	50.000
576p	31.250	50.000
720p	37.500	50.000
	45.000	60.000
1080i	28.125	50.000
	33.750	60.000
1080p	56.250	50.000
	67.500	60.000
1080PsF	27.000	24.000
	28.125	25.000
	33.750	30.000

\*1: WX520/WX450ST, \*2: WUX450/WUX400ST

- \* The specifications in the table above are subject to change without notice.
- \* This projector does not support any computer output signal with a dot clock of higher than 162 MHz.
- \* Use a computer cable in which all pins are connected. If the cable is a type in which all pins are not connected, the image may not be correctly displayed.

# Product Specifications

## ■ Projector WUX450/WX520

Model name		WUX450	WX520
Display system		RGB liquid crystal system	
Optical system		Color separation by dichroic mirror / polarizing beam splitter and color composition by prism	
Display device	Type	Reflective liquid crystal panel	
	Size / Aspect ratio	0.71" x 3 / 16:10	0.70" x 3 / 16:10
	Drive system	Active matrix system	
	Number dots / Total number dots	2,304,000 (1920 x 1200) x 3 panels / 6,912,000	1,296,000 (1440 x 900) x 3 panels / 3,888,000
Projection lens	Zoom ratio / Focal length / F value	1.8x / 21.7 – 39.0 mm / f2.8	
	Zooming / Focusing system	Manual / Manual	
	Lens shift	V: 0% to +60% (manual) H: ±10% (manual)	V: 0% to +62% (manual) H: ±10% (manual)
Light source		250-NSHA 260 W	
Image size (projection distance)		40" to 300" (1.2 m to 16.2 m / 3.9' to 53.1')	40" to 300" (1.2 m to 16.6 m / 3.9' to 54.5')
Number of colors		16,770,000 colors (full color)	
Brightness*2 (in presentation mode)		4500 lumen	5200 lumen
Contrast ratio*2		2000:1 (Fully white:fully black, presentation mode, Iris [On])	
Ratio of brightness at periphery to center*2		90%	
Speaker		5W monaural x 1	
Maximum input resolution		1920 x 1200 dots	1920 x 1080 dots
Video signals	Analog PC input	WUXGA*1, WSXGA+, UXGA, WXGA+, SXGA+, SXGA, WXGA, XGA, SVGA, VGA	
	Digital PC input	D-WUXGA*1, D-WSXGA+, D-UXGA, D-WXGA+, D-SXGA+, D-SXGA, D-WXGA, D-XGA, D-SVGA, D-VGA	
	HDMI input	From connected computers: WUXGA*1, WSXGA+, UXGA, WXGA+, SXGA+, SXGA, WXGA, XGA, SVGA, VGA From connected AV equipment: 1080p, 1080i, 720p, 576p, 480p	
	Component video input	1080PsF, 1080p, 1080i, 720p, 576p, 576i, 480p, 480i	
Input terminal	DVI-I terminal	Analog PC, Digital PC (29-pin DVI connector)	
	HDMI terminal	Digital PC, digital video input (deep color only)	
	ANALOG PC / COMPONENT terminal	Analog PC, Component (mini D-sub 15-pin)	
	LAN terminal	Networked multi-projection (RJ-45)	
	USB Port	JPEG images (USB Mass Storage Class)	
	CONTROL terminal	RS-232C (D-sub 9-pin)	
	REMOTE terminal	Wired remote control (3.5ø stereo mini jack)	
AUDIO IN terminal	Audio signal (3.5ø stereo mini jack x 2)		
AUDIO OUT terminal	Audio signal (3.5ø stereo mini jack)		

Model name		WUX450	WX520
Input signal	Digital PC	TMDS (Transition Minimized Differential Signaling)	
	Analog PC	0.7Vp-p, positive polarity, impedance = 75Ω Horizontal / vertical synchronization: TTL level, negative or positive polarity	
	Component video	COMPONENT: Separate Y Cb/Pb Cr/Pr signal Y: 1Vp-p, negative synchronization, impedance = 75Ω Cb/Pb: 0.7Vp-p, impedance = 75Ω Cr/Pr: 0.7Vp-p, impedance = 75Ω	
	Audio	Impedance = 47kΩ or more	
Noise		38 / 32dB (Lamp mode: Full power/Power saver)	
Operating temperature		0°C (32°F) - 40°C (104°F)	
Power supply		AC100V - 240V 50 / 60Hz	
Power consumption (Full power / power saver / low-power standby with LAN on / standby with LAN off)		365W / 295W / 0.6W / 0.2W	355W / 285W / 0.6W / 0.2W
Dimensions		337 mm (W) x 134 mm (H) x 370 mm (D) / 13.3 (W) x 5.3 (H) x 14.6 (D) in (including the projection)	
Mass		5.9 kg / 13.0 lbs	
Accessories		Remote control, remote control dry-cell batteries, power cord, PC cable, lens cap, User's Manual (this manual), Important Information and Warranty Card	

\*1 WUX450 only

\*2 Compliance with ISO21118-2012

## WUX400ST/WX450ST

Model name		WUX400ST	WX450ST
Display system		RGB liquid crystal system	
Optical system		Color separation by dichroic mirror / polarizing beam splitter and color composition by prism	
Display device	Type	Reflective liquid crystal panel	
	Size / Aspect ratio	0.71" x 3 / 16:10	0.70" x 3 / 16:10
	Drive system	Active matrix system	
	Number dots / Total number dots	2,304,000 (1920 x 1200) x 3 panels / 6,912,000	1,296,000 (1440 x 900) x 3 panels / 3,888,000
Projection lens	Focal length / F value	8.8 mm / f2.7	
	Focusing system	Manual	
	Lens shift	V: 0% to +75% (manual) H: ±10% (manual)	V: 0% to +77% (manual) H: ±10% (manual)
Light source		250-NSHA 260 W	
Image size (projection distance)		50" to 200" (0.60 m to 2.42 m / 2.0' to 7.4')	50" to 200" (0.61 m to 2.48 m / 2.0' to 8.1')
Number of colors		16,770,000 colors (full color)	
Brightness*2 (in presentation mode)		4000 lumen	4500 lumen
Contrast ratio*2		2000:1 (Fully white:fully black, presentation mode, Iris [On])	

## Product Specifications

Model name		WUX400ST	WX450ST
Ratio of brightness at periphery to center*2		80%	
Speaker		5W monaural x 1	
Maximum input resolution		1920 x 1200 dots	1920 x 1080 dots
Video signals	Analog PC input	WUXGA*1, WSXGA+, UXGA, WXGA+, SXGA+, SXGA, WXGA, XGA, SVGA, VGA	
	Digital PC input	D-WUXGA*1, D-WSXGA+, D-UXGA, D-WXGA+, D-SXGA+, D-SXGA, D-WXGA, D-XGA, D-SVGA, D-VGA	
	HDMI input	From connected computers: WUXGA*1, WSXGA+, UXGA, WXGA+, SXGA+, SXGA, WXGA, XGA, SVGA, VGA From connected AV equipment: 1080p, 1080i, 720p, 576p, 480p	
	Component video input	1080PsF, 1080p, 1080i, 720p, 576p, 576i, 480p, 480i	
Input terminal	DVI-I terminal	Analog PC, Digital PC (29-pin DVI connector)	
	HDMI terminal	Digital PC, digital video input (deep color only)	
	ANALOG PC / COMPONENT terminal	Analog PC, Component (mini D-sub 15-pin)	
	LAN terminal	Networked multi-projection (RJ-45)	
	USB Port	JPEG images (USB Mass Storage Class)	
	CONTROL terminal	RS-232C (D-sub 9-pin)	
	REMOTE terminal	Wired remote control (3.5ø stereo mini jack)	
	AUDIO IN terminal	Audio signal (3.5ø stereo mini jack x 2)	
AUDIO OUT terminal		Audio signal (3.5ø stereo mini jack)	
Input signal	Digital PC	TMDS (Transition Minimized Differential Signaling)	
	Analog PC	0.7Vp-p, positive polarity, impedance = 75Ω Horizontal / vertical synchronization: TTL level, negative or positive polarity	
	Component video	COMPONENT: Separate Y Cb/Pb Cr/Pr signal Y: 1Vp-p, negative synchronization, impedance = 75Ω Cb/Pb: 0.7Vp-p, impedance = 75Ω Cr/Pr: 0.7Vp-p, impedance = 75Ω	
	Audio	Impedance = 47kΩ or more	
Noise		38 / 32dB (Lamp mode: Full power/Power saver)	
Operating temperature		0°C (32°F) - 40°C (104°F)	
Power supply		AC100V - 240V 50 / 60Hz	
Power consumption (Full power / power saver / low-power standby with LAN on / standby with LAN off)		365W / 295W / 0.6W / 0.2W	355W / 285W / 0.6W / 0.2W
Dimensions		337 mm (W) x 134 mm (H) x 415 mm (D) / 13.3 (W) x 5.3 (H) x 16.3 (D) in (including the projection)	
Mass		6.3 kg / 13.9 lbs	
Accessories		Remote control, remote control dry-cell batteries, power cord, PC cable, User's Manual (this manual), Important Information and Warranty Card	

\*1 WUX400ST only

\*2 Compliance with ISO21118-2012



- \* 99.99% or more of the LCD panel pixels are effective. During projection, 0.01% or less of pixels may stay lit or unlit due to the characteristics of the LCD panel.
- \* Using the projector continuously for an extended period of time may accelerate the deterioration of optical parts.

### ■ Remote control

Model number	RS-RC06
Power supply	DC 3.0V, using two AAA-size batteries
Operating range	Approx. 8 m $\pm 25^\circ$ horizontal and vertical (to infrared remote receiver)
Dimensions	43 mm (W) x 23 mm (H) x 135 mm (D) / 1.7 (W) x 0.9 (H) x 5.3 (D) in
Weight	56 g / 2.0 oz

■ External View

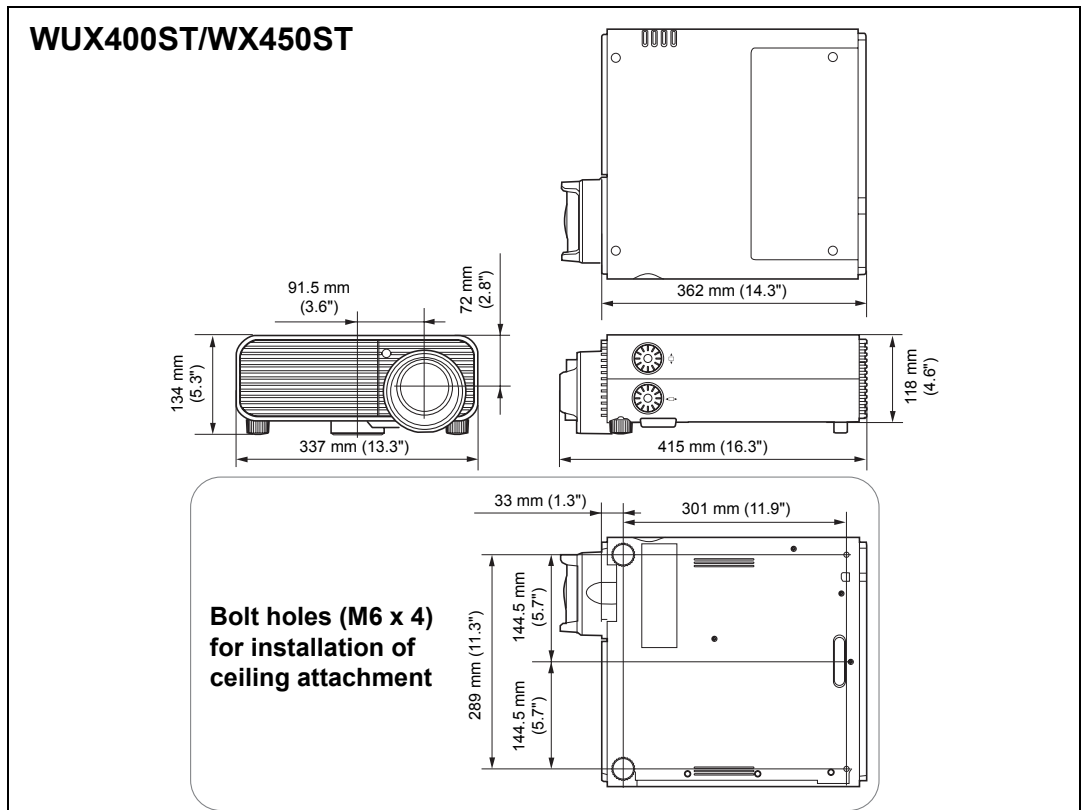
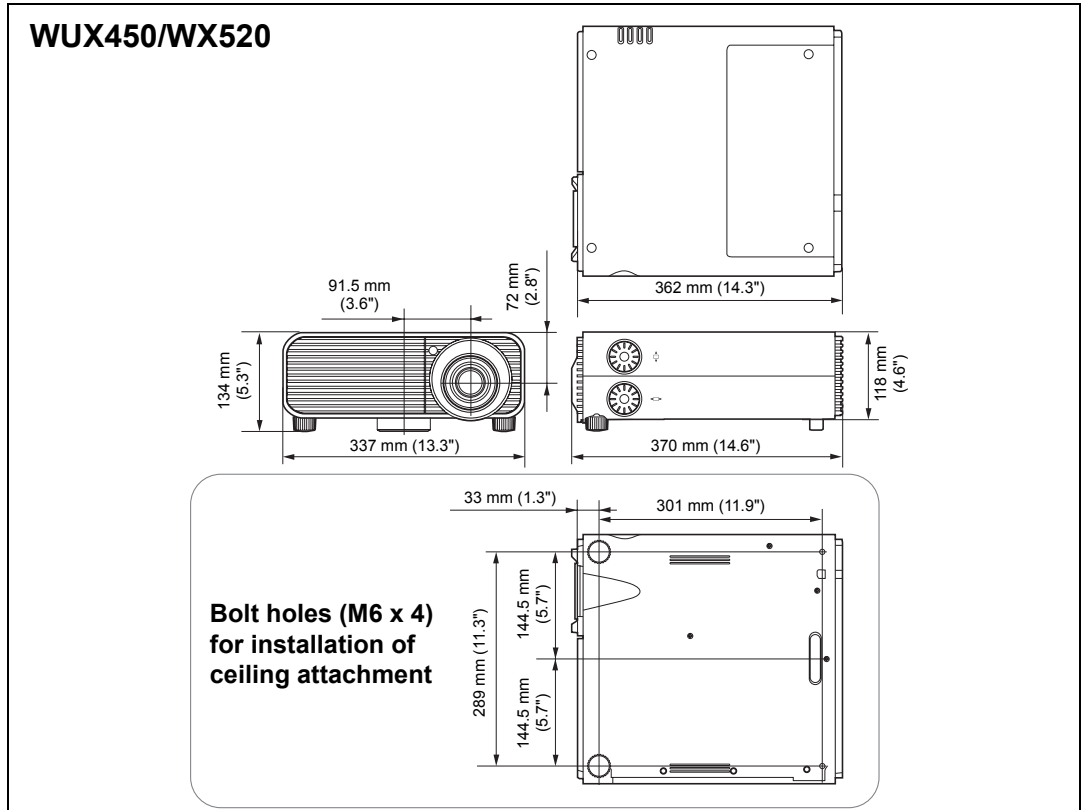

## ■ ANALOG PC-2 / COMPONENT terminal

This terminal is used as a computer ANALOG PC input or COMPONENT input terminal. Use a D-sub computer cable.

The terminal specifications for the ANALOG PC input and COMPONENT input are the same.

### Mini D-sub 15-pin

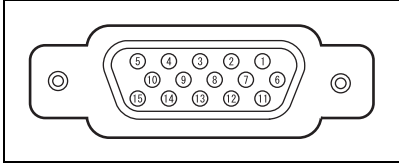

Pin No.	Signal	Pin No.	Signal
1	R	9	+5 V power
2	G	10	Ground (Vertical sync.)
3	B	11	Ground
4	OPEN	12	DDC data
5	Ground (Horizontal sync.)	13	Horizontal sync.
6	Ground (R)	14	Vertical sync.
7	Ground (G)	15	DDC clock
8	Ground (B)		

## ■ Service Port (CONTROL)

### Pin assignment

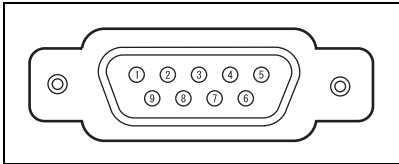

Pin No.	Signal
1	OPEN
2	RxD
3	TxD
4	OPEN
5	GND
6	OPEN
7	Internal pull-up
8	OPEN
9	OPEN

### Communication format

Communication mode : RS-232-C, asynchronous, half-duplex communication

Communication speed : 19200bps

Character length : 8 bits

Stop bits : 2 bits

Parity : None

Flow control : None

## Control commands

Commands		ASCII representation	Binary representation
Power supply	Power on	POWER=ON<CR>	50h 4Fh 57h 45h 52h 3Dh 4Fh 4Eh 0Dh
	Power off	POWER=OFF<CR>	50h 4Fh 57h 45h 52h 3Dh 4Fh 46h 46h 0Dh
Power status acquisition		GET=POWER<CR>	47h 45h 54h 3Dh 50h 4Fh 57h 45h 52h 0Dh
Input source	HDMI	INPUT=HDMI<CR>	49h 4Eh 50h 55h 54h 3Dh 48h 44h 4Dh 49h 0Dh
	Digital PC	INPUT=D-RGB<CR>	49h 4Eh 50h 55h 54h 3Dh 44h 2Dh 52h 47h 42h 0Dh
	Analog PC-1	INPUT=A-RGB1<CR>	49h 4Eh 50h 55h 54h 3Dh 41h 2Dh 52h 47h 42h 31h 0Dh
	Analog PC-2	INPUT=A-RGB2<CR>	49h 4Eh 50h 55h 54h 3Dh 41h 2Dh 52h 47h 42h 32h 0Dh
	Component	INPUT=COMP<CR>	49h 4Eh 50h 55h 54h 3Dh 43h 4Fh 4Dh 50h 0Dh
	LAN	INPUT=LAN<CR>	49h 4Eh 50h 55h 54h 3Dh 4Ch 41h 4Eh 0Dh
	USB	INPUT=USB<CR>	49h 4Eh 50h 55h 54h 3Dh 55h 53h 42h 0Dh
Input source acquisition		GET=INPUT<CR>	47h 45h 54h 3Dh 49h 4Eh 50h 55h 54h 0Dh
Image mode	Standard	IMAGE=STANDARD<CR>	49h 4Dh 41h 47h 45h 3Dh 53h 54h 41h 4Eh 44h 41h 52h 44h 0Dh
	Presentation	IMAGE=PRESENTATION<CR>	49h 4Dh 41h 47h 45h 3Dh 50h 52h 45h 53h 45h 4Eh 54h 41h 54h 49h 4Fh 4Eh 0Dh
	Photo/sRGB	IMAGE=PHOTO_SRGB<CR>	49h 4Dh 41h 47h 45h 3Dh 50h 48h 4Fh 54h 4Fh 5Fh 53h 52h 47h 42h 0Dh
	Dynamic	IMAGE=DYNAMIC<CR>	49h 4Dh 41h 47h 45h 3Dh 44h 59h 4Eh 41h 4Dh 49h 43h 0Dh
	Video	IMAGE=VIDEO<CR>	49h 4Dh 41h 47h 45h 3Dh 56h 49h 44h 45h 4Fh 0Dh
Image mode	User 1	IMAGE=USER_1<CR>	49h 4Dh 41h 47h 45h 3Dh 55h 53h 45h 52h 5Fh 31h 0Dh
	User 2	IMAGE=USER_2<CR>	49h 4Dh 41h 47h 45h 3Dh 55h 53h 45h 52h 5Fh 32h 0Dh
	User 3	IMAGE=USER_3<CR>	49h 4Dh 41h 47h 45h 3Dh 55h 53h 45h 52h 5Fh 33h 0Dh
	User 4	IMAGE=USER_4<CR>	49h 4Dh 41h 47h 45h 3Dh 55h 53h 45h 52h 5Fh 34h 0Dh
	User 5	IMAGE=USER_5<CR>	49h 4Dh 41h 47h 45h 3Dh 55h 53h 45h 52h 5Fh 35h 0Dh
Image mode acquisition		GET=IMAGE<CR>	47h 45h 54h 3Dh 49h 4Dh 41h 47h 45h 0Dh
Brightness	Brightness value setting	BRI=<value><CR>	42h 52h 49h 3Dh <numeric code> 0Dh
Brightness acquisition		GET=BRI<CR>	47h 45h 54h 3Dh 42h 52h 49h 0Dh
Sharpness adjustment function	Sharpness value setting	SHARP=<value><CR>	53h 48h 41h 52h 50h 3Dh <numeric code> 0Dh

Commands		ASCII representation	Binary representation
Sharpness acquisition		GET=SHARP<CR>	47h 45h 54h 3Dh 53h 48h 41h 52h 50h 0Dh
Contrast	Contrast value setting	CONT=<value><CR>	43h 4Fh 4Eh 54h 3Dh <numeric code> 0Dh
Contrast acquisition		GET=CONT<CR>	47h 45h 54h 3Dh 43h 4Fh 4Eh 54h 0Dh
Aspect	Auto	ASPECT=AUTO<CR>	41h 53h 50h 45h 43h 54h 3Dh 41h 55h 54h 4Fh 0Dh
	4:3	ASPECT=4:3<CR>	41h 53h 50h 45h 43h 54h 3Dh 34h 3Ah 33h 0Dh
	16:9	ASPECT=16:9<CR>	41h 53h 50h 45h 43h 54h 3Dh 31h 36h 3Ah 39h 0Dh
	16:10	ASPECT=16:10<CR>	41h 53h 50h 45h 43h 54h 3Dh 31h 36h 3Ah 31h 30h 0Dh
	Zoom	ASPECT=ZOOM<CR>	41h 53h 50h 45h 43h 54h 3Dh 5Ah 4Fh 4Fh 4Dh 0Dh
	True size	ASPECT=TRUE<CR>	41h 53h 50h 45h 43h 54h 3Dh 54h 52h 55h 45h 0Dh
Aspect value acquisition		GET=ASPECT<CR>	47h 45h 54h 3Dh 41h 53h 50h 45h 43h 54h 0Dh
Lamp mode	Full power	LAMP=FULL<CR>	4Ch 41h 4Dh 50h 3Dh 46h 55h 4Ch 4Ch 0Dh
	Power saver	LAMP=ECO<CR>	4Ch 41h 4Dh 50h 3Dh 45h 43h 4Fh 0Dh
Lamp mode value acquisition		GET=LAMP<CR>	47h 45h 54h 3Dh 4Ch 41h 4Dh 50h 0Dh
Blank	Blank On	BLANK=ON<CR>	42h 4Ch 41h 4Eh 4Bh 3Dh 4Fh 4Eh 0Dh
	Blank Off	BLANK=OFF<CR>	42h 4Ch 41h 4Eh 4Bh 3Dh 4Fh 46h 46h 0Dh
Blank acquisition		GET=BLANK<CR>	47h 45h 54h 3Dh 42h 4Ch 41h 4Eh 4Bh 0Dh

## Numerics

6-axis color adjust ..... 104

## A

Adjusting keystone distortion ..... 68

Adjusting the volume..... 77

Air filter..... 199

Ambient light ..... 102

Analog PC..... 53, 137, 138

Analog PC-1..... 137

ANALOG PC-1 / DVI-I input  
terminal..... 53, 137, 138

Analog PC-2..... 137, 138

ANALOG PC-2 / COMPONENT  
terminal..... 53, 137, 138

ASPECT..... 67

Aspect..... 66, 287

AUDIO IN terminal  
..... 44, 137, 138, 141, 153

AUDIO OUT terminal ..... 44, 139, 142

Auto (Aspect) ..... 66

AUTO PC ..... 57

Auto PC..... 57

## B

Beep..... 111

BLANK ..... 76

Brightness ..... 99

Broadcast Mode..... 249

## C

Ceiling mounted ..... 146

Classroom Mode..... 236

Component ..... 53, 141

Connection to computer..... 137

Contrast ..... 99

Corner adjustment ..... 150

Customizing system operation..... 108

## D

D. ZOOM..... 78

DHCP ..... 174

Digital image shift..... 63

Digital PC ..... 53, 138

Digital zoom..... 40

Direct Mode..... 222

Direct power on ..... 111

Display resolution (Preparing the  
computer) ..... 55

Displaying logo..... 110

DVI ..... 53, 138

DVI-I ..... 137, 138

DVI-I input terminal ..... 44

Dynamic gamma ..... 103

## E

Edge blending ..... 159

Electronic zoom..... 149

## F

Factory defaults..... 121

FREEZE ..... 76

## G

Gamma ..... 100

Guide..... 154

## H

HDMI ..... 53, 139, 140

HDMI color space..... 92

HDMI IN terminal..... 44, 139, 140

HDMI input level..... 92

HDMI over scan ..... 93

Horizontal pixels ..... 91

Horizontal position..... 90

Horizontal-vertical keystone ..... 150

**I**

IMAGE .....	72
Image adjustment menu .....	84
Image flip H/V (Ceiling mounted / Rear projection).....	146
Image mode (Image quality) .....	71
Information .....	84, 122
INPUT .....	54
Input signal select .....	53
Input terminal .....	44
Connecting to AV equipment .....	140
Connection to computer .....	137

**K**

Key lock .....	112
KEYSTONE .....	68
Keystone .....	68

**L**

Lamp counter .....	119
Lamp mode .....	107
Lamp replacement .....	119, 156, 201, 202
LAN port.....	44
Language .....	115
LED indicator .....	42, 280

**M**

Meeting Mode .....	226
Memory color correction .....	104
Menu .....	84
Menu display time .....	156
Menu position.....	154
Motion blur reduction .....	114
MUTE .....	77
Muting .....	77

**N**

Network function .....	170, 171, 172
Network password setting .....	170
Network setting initialization.....	175
Network settings.....	84
Network settings lock .....	169
Networked Multi-Projection .....	205

**O**

OK .....	41
Optical zoom .....	57

**P**

Password settings .....	116
Performing Gamma Correction .....	100
PJLink .....	175
Positional lock .....	146
POWER.....	52, 74
Power saver settings.....	73
Power-saving .....	73
Progressive .....	93
Projector on .....	110

**R**

Rear projection.....	146
Register network password.....	171
Register password.....	117
Remote control.....	34, 40, 113
Reset.....	107, 121

**S**

Screen aspect .....	60, 148, 287
Screen color .....	153
Screen when blank.....	109
Selecting a language.....	115, 144
Setting display status .....	87
Sharpness .....	100
Side control .....	42
Signal type .....	292

Slideshows .....	94
Split-screen display .....	81
System settings menu.....	84

## T

TCP/IP settings .....	174
Test pattern .....	158, 291
Total dots.....	89
Tracking .....	89
True size (Aspect).....	66
Turning on external monitor output (preparing the notebook computer) .....	145

## U

USB.....	79
USB Port.....	44

## V

Vertical pixels .....	91
Vertical position.....	90
VOL.....	77

## W

WARNING indicator .....	43, 280
-------------------------	---------

## Z

Zooming an image .....	78
------------------------	----



# Option

- Lamp  
Part No.: RS-LP08
- Ceiling attachment  
Part No.: RS-CL12  
(WUX450/WX520)
- Ceiling attachment  
Part No.: RS-CL13  
(WUX400ST/WX450ST)
- Ceiling-mount pipe  
(400 - 600 mm / 15.7 - 23.6 in)  
Part No.: RS-CL08\*
- Ceiling-mount pipe  
(600 - 1000 mm / 23.6 - 39.4 in)  
Part No.: RS-CL09\*
- Air filter  
Part No.: RS-FL02
- Remote control  
Part No.: RS-RC06  
RS-RC05
- Option feet  
Part No.: RS-FT01

\* Use the above materials to hang the projector from the ceiling. For details, refer to the assembly and installation manual provided with the ceiling attachment RS-CL12/RS-CL13.

# Menu Configuration

## Input Settings Menu

\*: Factory defaults (setting after reset)

Aspect	<b>Digital PC / Analog PC-1/2 / HDMI (when [HDMI In] is [Computer])</b> P87 Auto* 16:10 16:9 4:3 True size <b>HDMI (when [HDMI In] is [Auto]) / Component</b> Auto* 16:9 4:3 Zoom True size <b>USB / LAN</b> Auto
Auto PC	<b>Analog PC-1 / 2</b> P88
Input signal select	<b>Analog PC-1 / 2</b> P88 640 x 480 : 1920 x 1200
Input signal settings	<b>Analog PC-1 / 2</b> Total dots P89 Tracking P89 Horizontal position P90 Vertical position P90 Horizontal pixels P91 Vertical pixels P91
HDMI input level	<b>HDMI</b> P92 Auto* Normal Expanded
HDMI color space	<b>HDMI</b> P92 Auto* RGB YCbCr
HDMI over scan*1	<b>HDMI</b> P93 Off On
Progressive	<b>Component / HDMI</b> P93 Off Film/auto* Video 1 Video 2 25p/30p(PsF)

\*1 Factory default settings are based on these conditions: [On] when HDMI ([HDMI In]) is [Auto], and [Off] when it is [Computer].

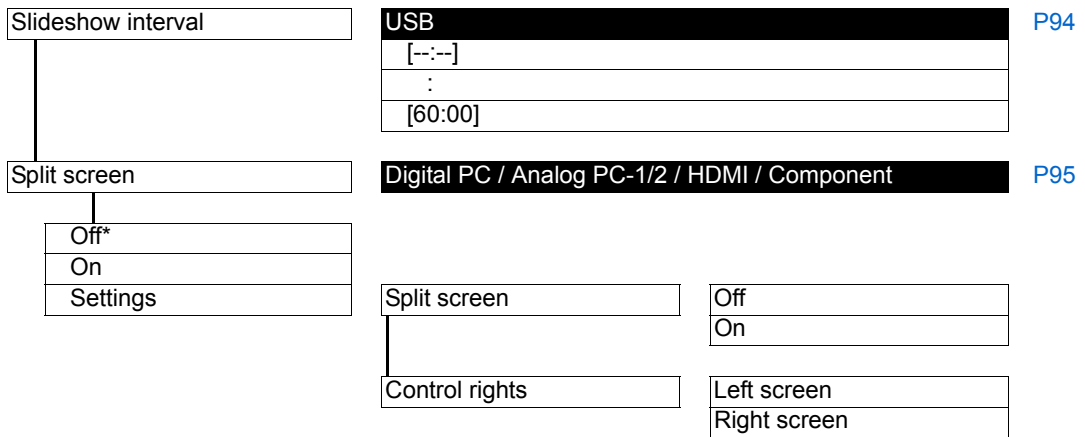

## Image Adjustment Menu

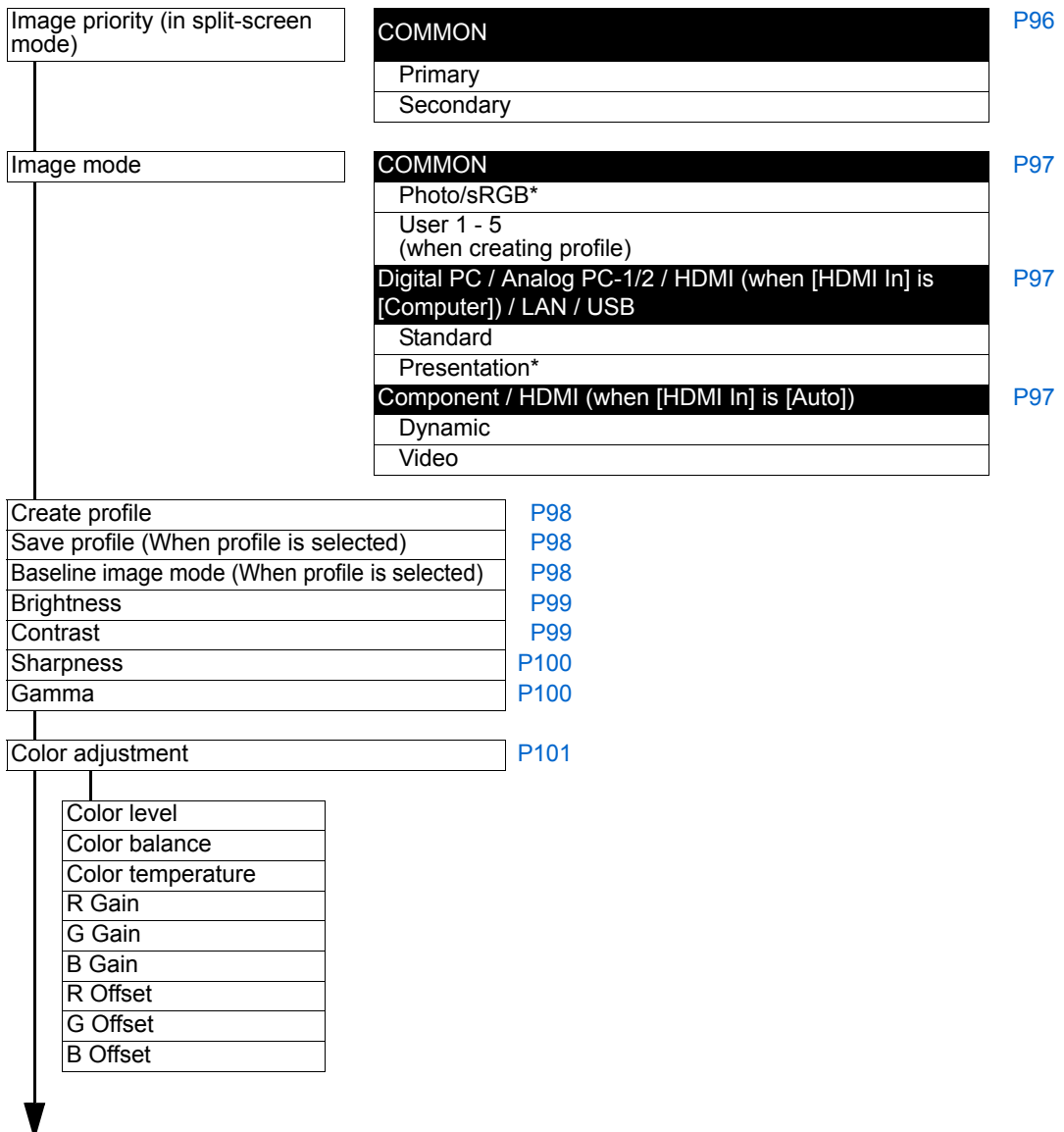

\*: Factory defaults (setting after reset)

# Menu Configuration

Advanced adjustment											
Ambient light (when Photo/sRGB is selected)	<table border="1"> <tr><td>Off*</td></tr> <tr><td>Adjust</td></tr> <tr> <td>Type</td> <td>Tungsten</td> </tr> <tr> <td></td> <td>Fluorescent</td> </tr> <tr> <td>Level</td> <td>L</td> </tr> <tr> <td></td> <td>H</td> </tr> </table>	Off*	Adjust	Type	Tungsten		Fluorescent	Level	L		H
Off*											
Adjust											
Type	Tungsten										
	Fluorescent										
Level	L										
	H										
Noise reduction*2	<table border="1"> <tr><td>Off</td></tr> <tr><td>Weak</td></tr> <tr><td>Middle</td></tr> <tr><td>Strong</td></tr> </table>	Off	Weak	Middle	Strong						
Off											
Weak											
Middle											
Strong											
Dynamic gamma*3	<table border="1"> <tr><td>Off</td></tr> <tr><td>Weak</td></tr> <tr><td>Middle</td></tr> <tr><td>Strong</td></tr> </table>	Off	Weak	Middle	Strong						
Off											
Weak											
Middle											
Strong											
Mem. color correct*4	<table border="1"> <tr> <td>Flesh</td> <td>Off</td> </tr> <tr> <td>Sky</td> <td>Weak</td> </tr> <tr> <td>Green</td> <td>Middle</td> </tr> <tr> <td></td> <td>Strong</td> </tr> </table>	Flesh	Off	Sky	Weak	Green	Middle		Strong		
Flesh	Off										
Sky	Weak										
Green	Middle										
	Strong										
6-axis color adjust	<table border="1"> <tr><td>Off*</td></tr> <tr> <td>Adjust</td> <td>Hue / Saturation / Brightness</td> </tr> <tr><td>Reset</td></tr> </table>	Off*	Adjust	Hue / Saturation / Brightness	Reset						
Off*											
Adjust	Hue / Saturation / Brightness										
Reset											
Fine-Tune Gamma	P105										
Iris	<table border="1"> <tr><td>Off*</td></tr> <tr><td>On</td></tr> </table>	Off*	On								
Off*											
On											
Lamp mode	<table border="1"> <tr><td>Full power*</td></tr> <tr><td>Power saver</td></tr> </table>	Full power*	Power saver								
Full power*											
Power saver											
Reset	OK / Cancel										

Factory default settings are set according to the following conditions.

- \*2 • For HDMI (when [HDMI In] is [Auto]), the factory default is [Off].
  - For Component, the factory default is [Weak].
- \*3 • For Analog PC-1/2, Digital PC or HDMI (when [HDMI In] is [Computer]), the factory default is [Off].
  - [Weak] by default for Component or HDMI (when [HDMI In] is [Auto]).
- \*4 • [Off] by default for HDMI (when [HDMI In] is [Computer]), or for Digital PC, Analog PC (1 or 2), USB, or LAN.
  - HDMI (when [HDMI In] is [Auto]) or COMPONENT: Weak

\*: Factory defaults (setting after reset)

## Install Settings Menu

Positional lock	Off* On	P146
Image flip H/V	None* Ceiling mounted Rear Rear, Ceiling mounted	P146
Screen aspect	16:10* 16:9 4:3 16:9 D. image shift 4:3 D. image shift	P148
Zoom (WUX400ST/WX450ST)		P149
Keystone	Horizontal-vertical keystone* Corner adjustment Reset	P150
Digital image shift	D.image shift adjustment	P150
Professional settings		
Micro-digital image shift	Off* Adjust	P151
Registration	Off* Adjust	P151
Fan mode	Normal* High altitude	P152
Vertical projection	Off* Upward Downward	P152
Edge Blending	Off* Adjust	P159
	Left Right Top Bottom Black level adjustment Reset	
Audio in terminal select		
HDMI	Off Audio in 1 Audio in 2 HDMI*	P153

\*: Factory defaults (setting after reset)

# Menu Configuration

Digital PC	Off	P153
	Audio in 1*	
	Audio in 2	
Analog PC-1	Off	P153
	Audio in 1*	
	Audio in 2	
Analog PC-2	Off	P153
	Audio in 1	
	Audio in 2*	
Component	Off	P153
	Audio in 1	
	Audio in 2*	
Screen color	Normal*	P153
	Greenboard	
	Adjust	
On screen		
Menu position		P154
Guide	Off	P154
	On*	
Show input status	Off	P155
	On*	
Overheat warning display	Off*	P155
	On	
Menu display time	Normal*	P156
	Extended	
Lamp warning display	Off	P156
	On*	
Air filter warning display	Off	P157
	On*	
Split screen ID display	Off	P157
	On*	
Test pattern	Off*	P158
	On	

\*: Factory defaults (setting after reset)

## System Settings Menu

User screen settings		
Logo capture	OK Cancel*	P108
Logo position	Upper L Upper R Center* Lower L Lower R	P108
No signal screen	Black Blue* User logo	P109
Screen when blank	Black* Blue User logo	P109
Projector on	Skip Canon logo* User logo	P110
Auto power-off	5 min. 10 min. 15 min.* 20 min. 30 min. 60 min. Disabled	P110
Direct power on	Off* On	P111
Beep	Off On*	P111
Key repeat	Off On*	P112
Key lock	Off* Main unit Remote (wireless)	P112
Remote control channel	Ch1 Ch2 Ch3 Ch4 Independent*	P113
Motion blur reduction	Off* On	P114

\*: Factory defaults (setting after reset)

# Menu Configuration

HDMI In	Auto*	P115	
	Computer		
Language	English	Turkish	P115
	German	Polish	
	French	Hungarian	
	Italian	Czech	
	Spanish	Danish	
	Portuguese	Arabic	
	Swedish	Chinese (Simplified)	
	Russian	Chinese (Traditional)	
	Dutch	Korean	
	Finnish	Japanese	
	Norwegian		
Other settings			
Password settings	Off*	P116	
	On		
Register password	Password input	P117	
Gamma restore	Off*	P118	
	Adjust		
Lamp counter	Return	P119	
	Reset (Yes / No)		
Air filter counter	Return	P120	
	Reset (Yes / No)		
Firmware		P121	
Factory defaults	OK / Cancel	P121	

## Network Settings Menu

Network settings lock	Unlock	P169
	Lock*	
Network password setting	Off	P170
	On*	
Register network password	Password input	P171
Network function (wired)	Off*	P171
	On	
Network standby settings	Normal	P172
	Low-power*	
Detailed settings (wired)		
IP address		P172

\*: Factory defaults (setting after reset)



Gateway address	P173
MAC address	P173
DHCP	<input type="text" value="Off*"/> P174 <input type="text" value="On"/>
TCP/IP settings	<input type="text" value="IP address"/> P174 <input type="text" value="Subnet mask"/> <input type="text" value="Gateway address"/> <input type="text" value="Enter"/>
Network setting initialization	P175
IP address (wired)	<input type="text" value="Shows the IP address"/>
PJLink	<input type="text" value="Off"/> P175 <input type="text" value="On*"/>
AMX Device Discovery	<input type="text" value="Off*"/> P176 <input type="text" value="On"/>
Crestron RoomView	<input type="text" value="Off*"/> P177 <input type="text" value="On"/>

## Information

Model name	P122
Input signal	
Firmware	
Serial no.	
E-mail sender address	
E-mail recipient address	
Projector name	
Location	
System information ID	

\*: Factory defaults (setting after reset)

**CANON INC.**

30-2, Shimomaruko 3-chome, Ohta-ku, Tokyo  
146-8501, Japan

U.S.A.

**CANON U.S.A. INC.**

One Canon Park, Melville, New York 11747,  
U.S.A.

For all inquires concerning this product, call toll  
free in the U.S. 1-800-OK-CANON

CANADA

**CANON CANADA INC. HEADQUARTERS**

6390 Dixie Road, Mississauga, Ontario L5T  
1P7, Canada

**CANON CANADA INC. MONTREAL  
BRANCH**

5990, Côte-de-Liesse, Montréal Québec H4T  
1V7, Canada

**CANON CANADA INC. CALGARY OFFICE**

2828, 16th Street, N.E. Calgary, Alberta T2E  
7K7, Canada

For all inquiries concerning this product, call  
toll free in Canada  
1-800-OK-CANON

EUROPE, AFRICA & MIDDLE EAST

**CANON EUROPE LTD.**

3 The Square, Stockley Park, Uxbridge,  
Middlesex, UB11 1ET United Kingdom

**CANON EUROPA N.V.**

Bovenkerkerweg 59, 1185 XB Amstelveen,  
The Netherlands

**CANON FRANCE S.A.S**

17, quai du President Paul Doumer, 92414  
Courbevoie Cedex, France

**CANON UK LTD.**

Woodhatch Reigate Surrey RH2 8BF, United  
Kingdom

**CANON DEUTSCHLAND GmbH**

Europark Fichtenhain A10, 47807 Krefeld,  
Germany

**CANON ITALIA S.p.A.**

Via Milano 8 I-20097 San Donato Milanese,  
Milano, Italy

**CANON Schweiz AG**

Geschäftsbereich Wiederverkauf,  
Industriestrasse 12, CH-8305 Dietlikon,  
Switzerland

**CANON GMBH**

Zetschegasse 11, A-1230 Wien, Austria

**CANON España, S.A.**

Av. De Europa, 6 Alcobendas 28108 Madrid,  
Spain

**CANON PORTUGAL S.A.**

Rua Alfredo da Silva, 14 Alfragide 2610-016  
Amadora, Portugal

**CANON Belgium N.V. / S.A.**

Berkenlaan 3, 1831 Diegem (Mechelen),  
Belgium

**CANON Netherland NV**

Neptunusstraat 1, 2132 JA Hoofddorp, The  
Netherlands

**CANON LUXEMBOURG S.A.**

Rue des Joncs 21, L-1818 Howald,  
Luxembourg

**CANON DANMARK A / S**

Knud Hoejgaards Vej 1 DK-2860 Soeborg,  
Danmark

**CANON OY**

Huopalahdentie 24 PL 1 00351 Helsinki,  
Finland

**CANON SVENSKA AB**

Gustav III:s Boulevard 26 169 88 Solna,  
Sweden

**CANON NORGE as**

Hallagerbakken 110, Postboks 33, Holmlia,  
1201 Oslo, Norway

CENTRAL & SOUTH AMERICA

**CANON LATIN AMERICA, INC.**

703 Waterford Way, Ste. 400 Miami, FL 33126,  
U.S.A.

ASIA

**CANON (China) Co., Ltd.**

15F Jinbao Building No.89 Jinbao Street,  
Dongcheng District, Beijing 100005, China

**CANON HONGKONG CO., LTD.**

19 / F., The Metropolis Tower, 10 Metropolis  
Drive, Hunghom, Kowloon, Hong Kong

**CANON SINGAPORE PTE. LTD.**

1 HarbourFront Avenue, #04-01 Keppel Bay  
Tower, Singapore 098632

**CANON KOREA CONSUMER IMAGING INC.**

Canon BS Tower 5F, #168-12 Samseong-  
dong, Gangnam-gu, Seoul, Korea

OCEANIA

**CANON AUSTRALIA PTY. LTD.**

1 Thomas Holt Drive, North Ryde, N.S.W.  
2113, Australia

**CANON NEW ZEALAND LTD.**

Akoranga Business Park, Akoranga Drive,  
Northcote, Auckland, New Zealand