

S420

» *User Manual* «



➤ Before using HiTi photo printer, please check the printer package content for the following items:

➤ HiTi Photo Printer x 1

➤ LCD Controller x 1

➤ Power Cord x 1

➤ USB Cable x 1

※ For the connection between the photo printer and the computer

➤ Paper Cassette x 1

➤ HiTi Bag x 1 (including following items...)

A. Printer User Manual x 1

B. Quick Guide x 1

C. PhotoDésirée Deluxe User Manual x 1

D. Notice Sheet x 1

E. Warranty Card x 1

F. Master CD x 1 (Includes the driver and PhotoDésirée Deluxe) x 1

➤ IDésirée Bag x 1 (including following items...)

A. IDésirée User Manual x 1

B. IDésirée Installation CD x 1

※ The package content varies according to different areas.

- ▶ Get to know S420 03
- ▶ Installing S420 04
- ▶ Standalone printing
 - ▶ A. Home Menu Introduction 09
 - ▶ B. Main Function Instruction 10
 - ▶ C. Special Function Instruction 16
- ▶ PC-link Printing 22
- ▶ Troubleshooting 23
- ▶ Contact HiTi 24

➤ To ensure proper printer operation, please read the following instructions thoroughly before using the S420 photo printer.

▶ LCD controller

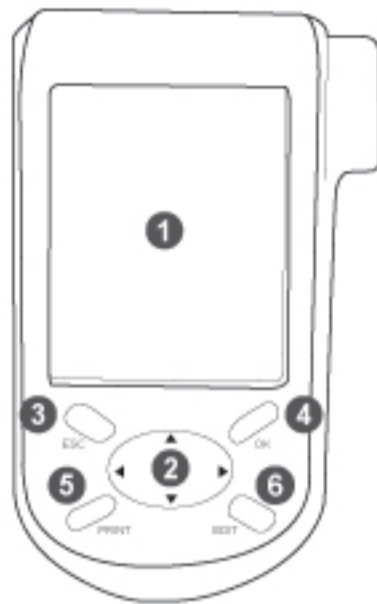

1. TFT Color LCD
2. Directional Button
3. [ESC]
4. [OK]
5. [PRINT]
6. [EDIT]

▶ Front view

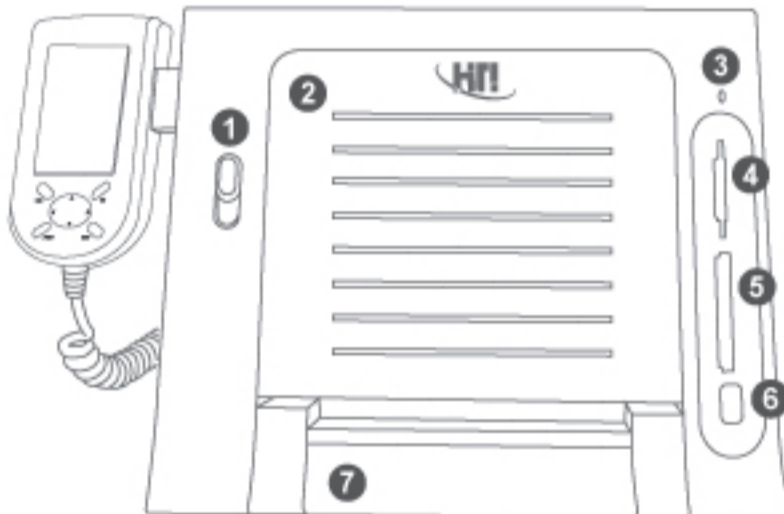

1. Ribbon Door Button
2. Ribbon Door
3. Indicator
4. MMC/SD/MS Memory Card Slot
5. CF Memory Card Slot
6. USB Host Slot
7. Paper Cassette Door

▶ Back view

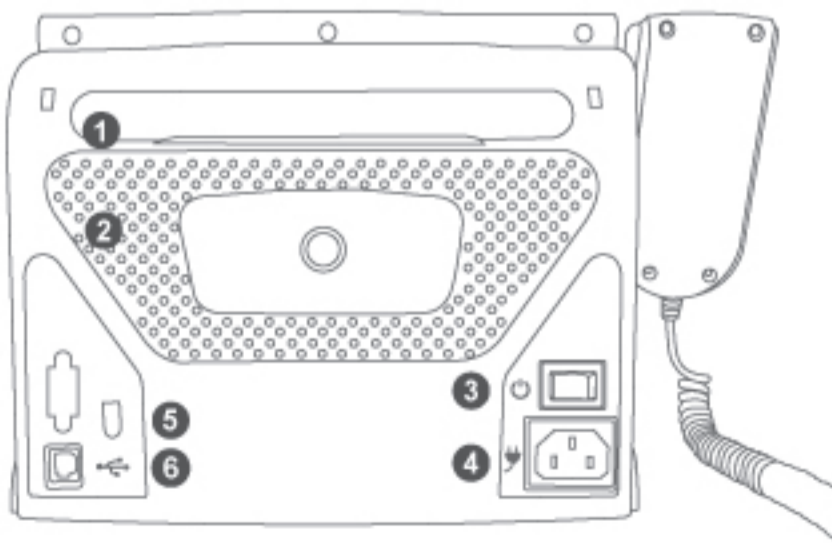

1. Hatchback
2. Heat Ventilation
3. Power Switch
4. Power Cord Socket
5. Controller Socket
6. USB Port

➤ Installing LCD controller

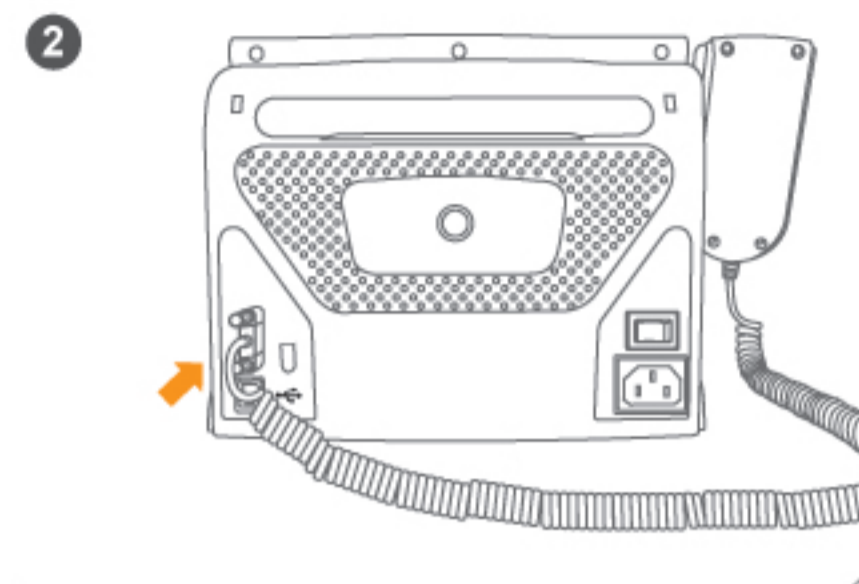
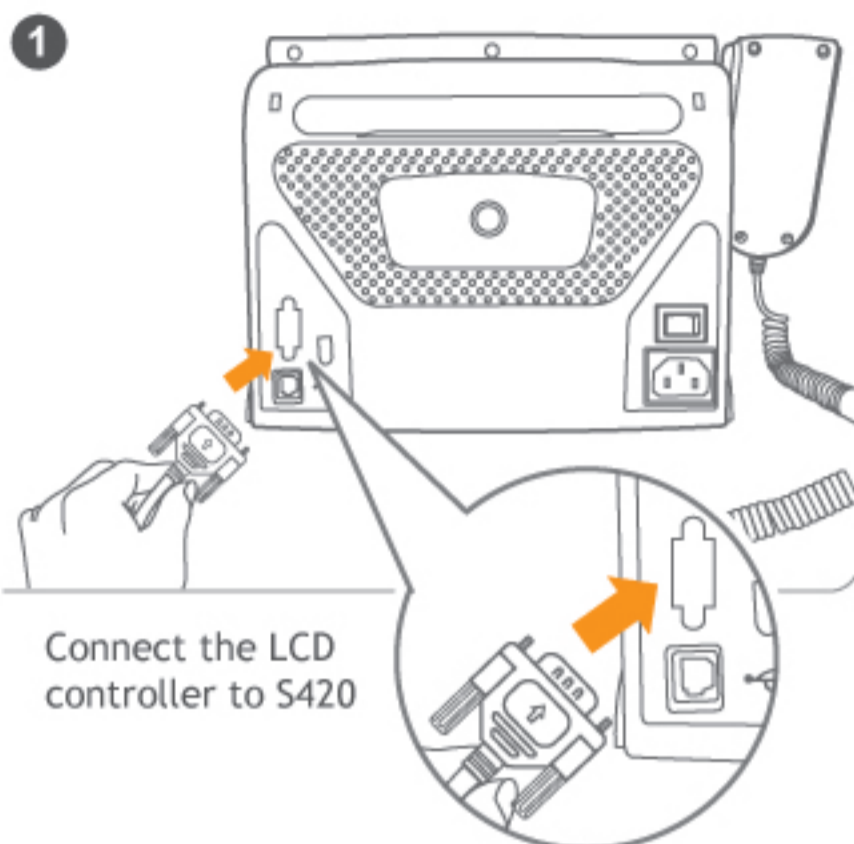

LCD controller installation is complete.

➤ Installing ribbon cartridge

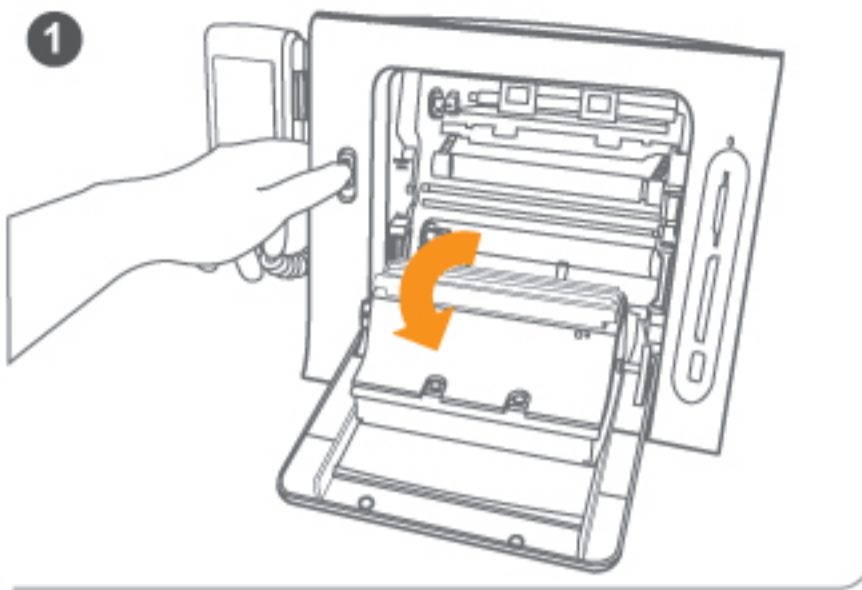

Push the **ribbon door button** to open the ribbon door.



Install the ribbon cartridge **inserting the left (indicated by the arrow) side of the ribbon first** followed by the right side.

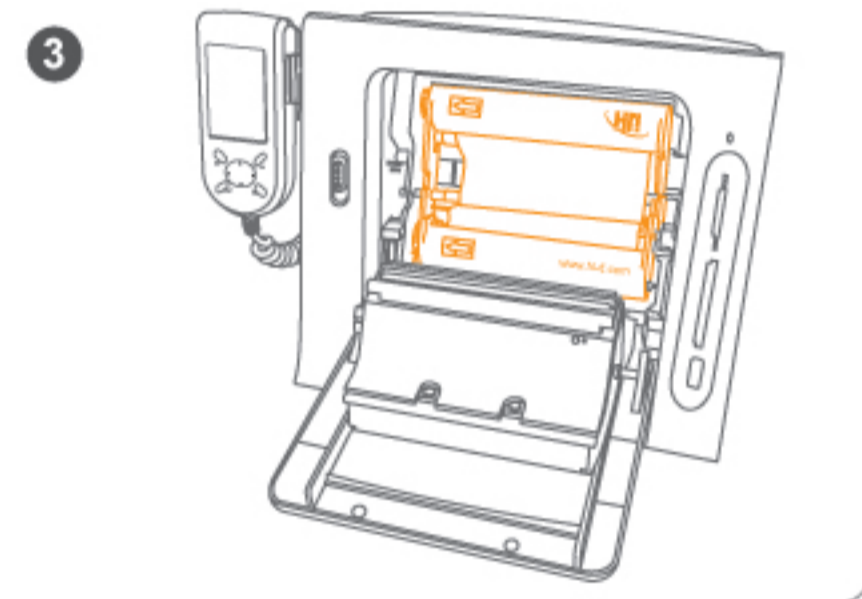

The ribbon has to be installed in the printer properly.



Close the ribbon door to complete the ribbon installation.

➤ Loading photo papers

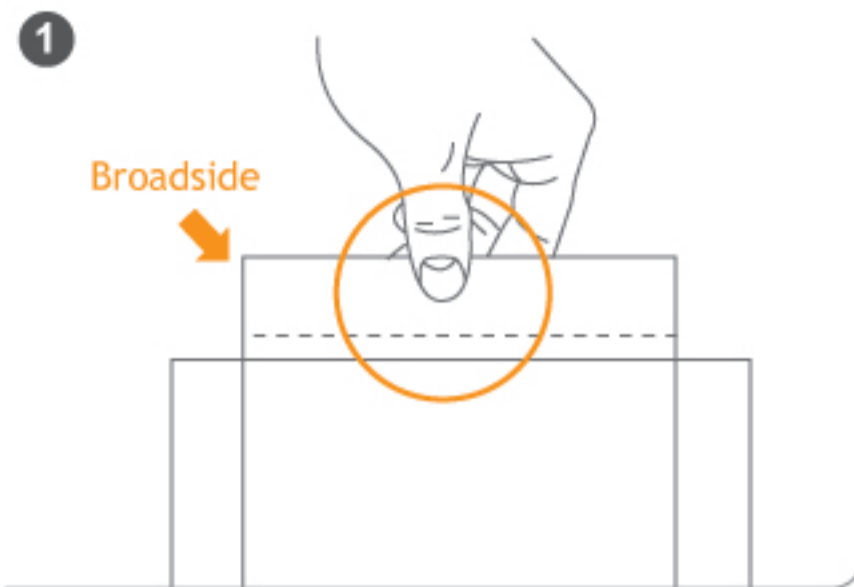

Follow the demonstration to correctly remove photo papers from the packing.

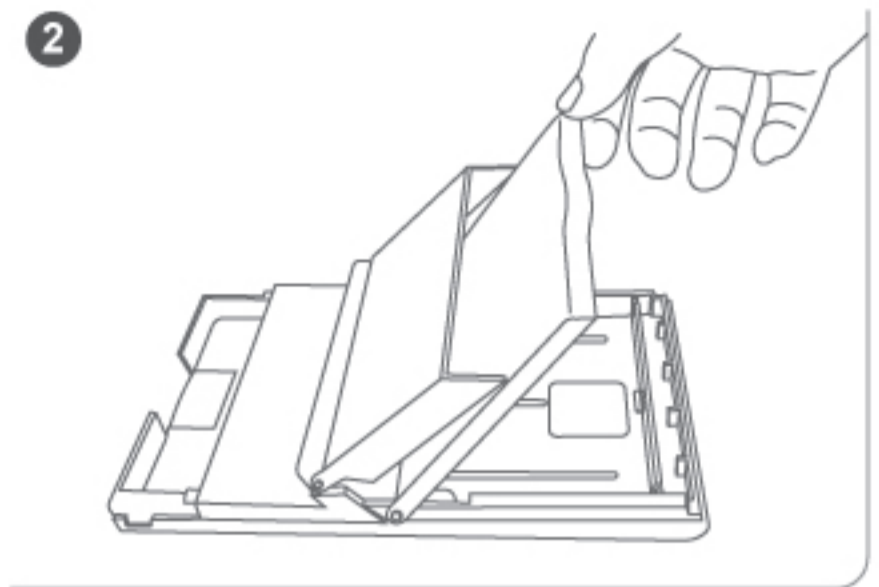

Open the paper cassette cover.

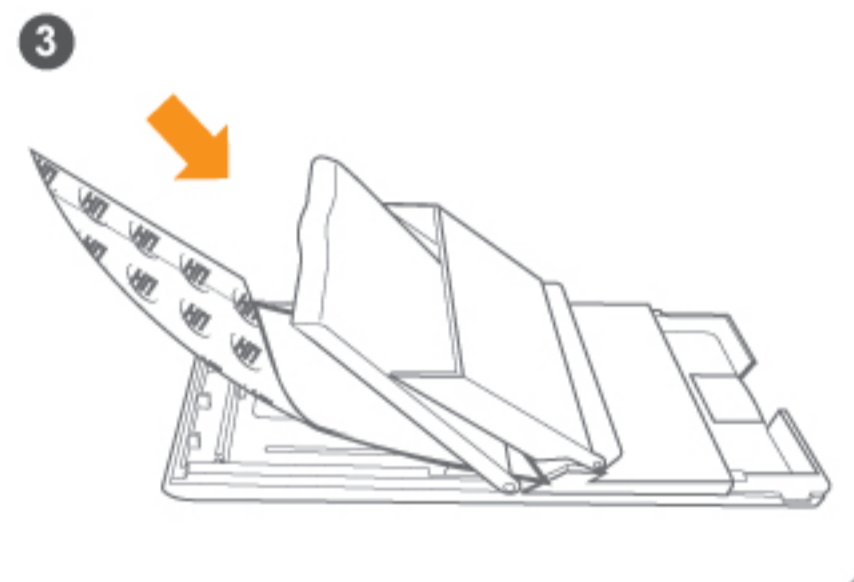

Load photo papers into the paper cassette and then close the cover.



Open the paper cassette door on the printer and insert the paper cassette.

※ Please hold the perforated side of photo paper and avoid touching the surface when taking them out from the packing

➤ Powering up the printer

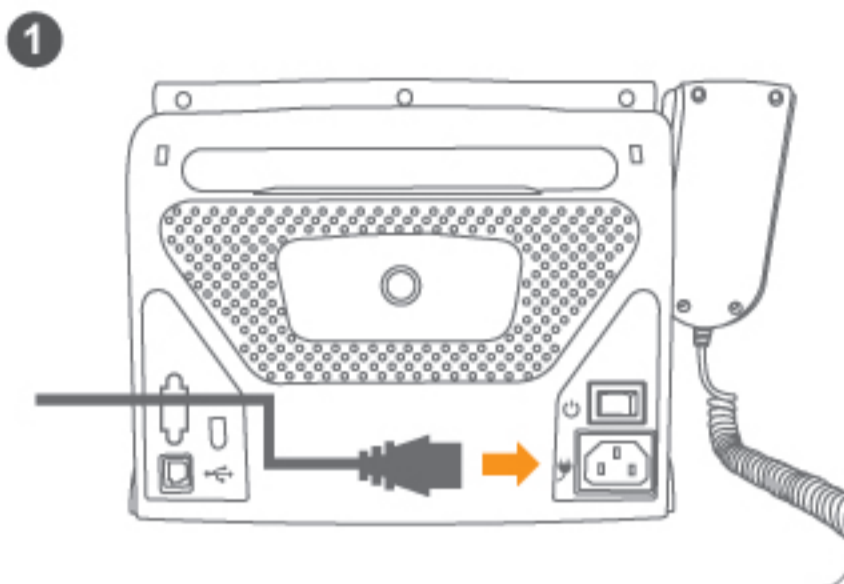

Plug the power cord into the power cord socket at the back of the printer.

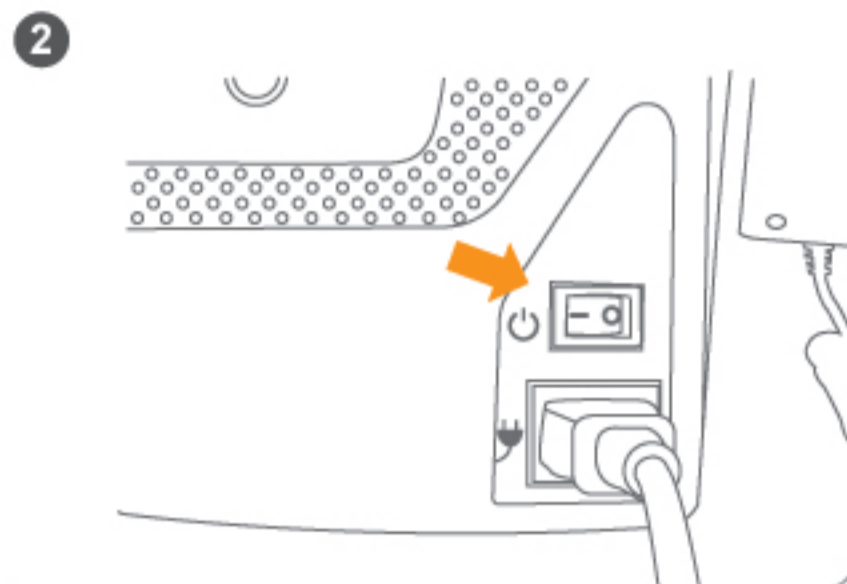

Turn on the power.

➤ Installation of Dust Proof Case



Installing the dust proof case

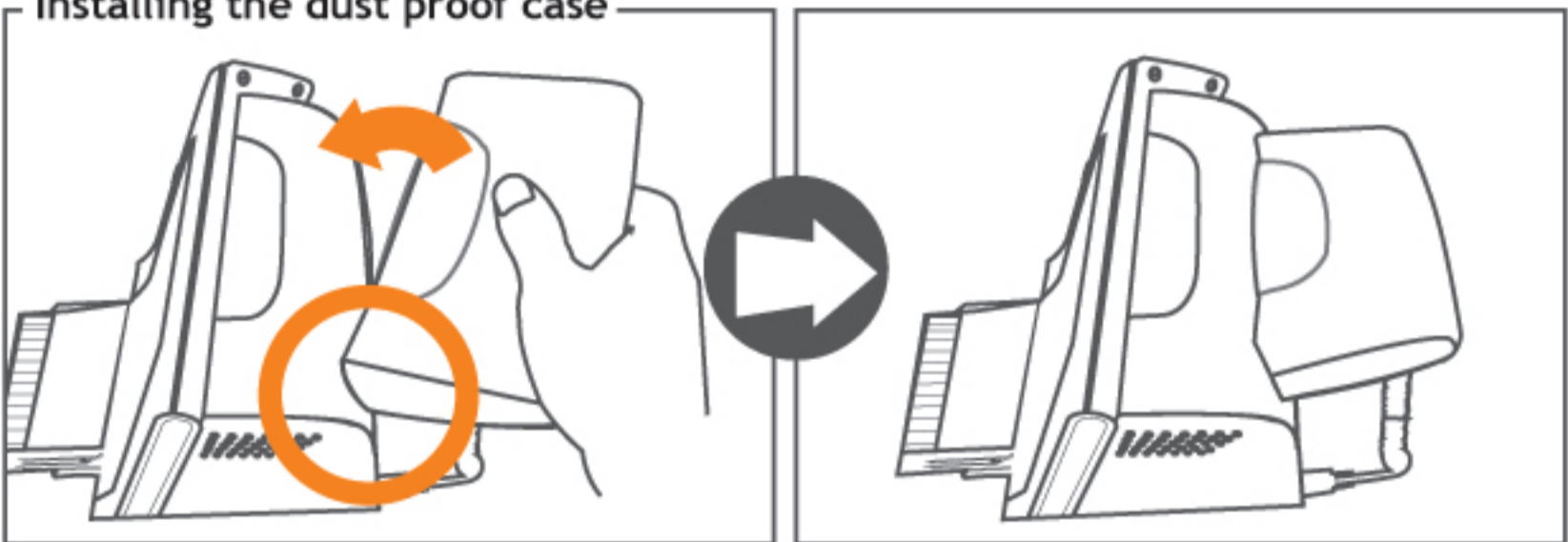

Gently insert the latch into the corresponding latch receiver opening on one side first, then gently push the latch on the opposite end of the dust proof case into the corresponding latch receiver opening to finish the installation.

Disassembling of the dust proof case



Hold the end of dust proof case firmly and gently push the dust proof case downward to uninstall the dust proof case.

Warning

Incorrect installation or disassembly way break the latch.

➤ A. Home Menu Introduction

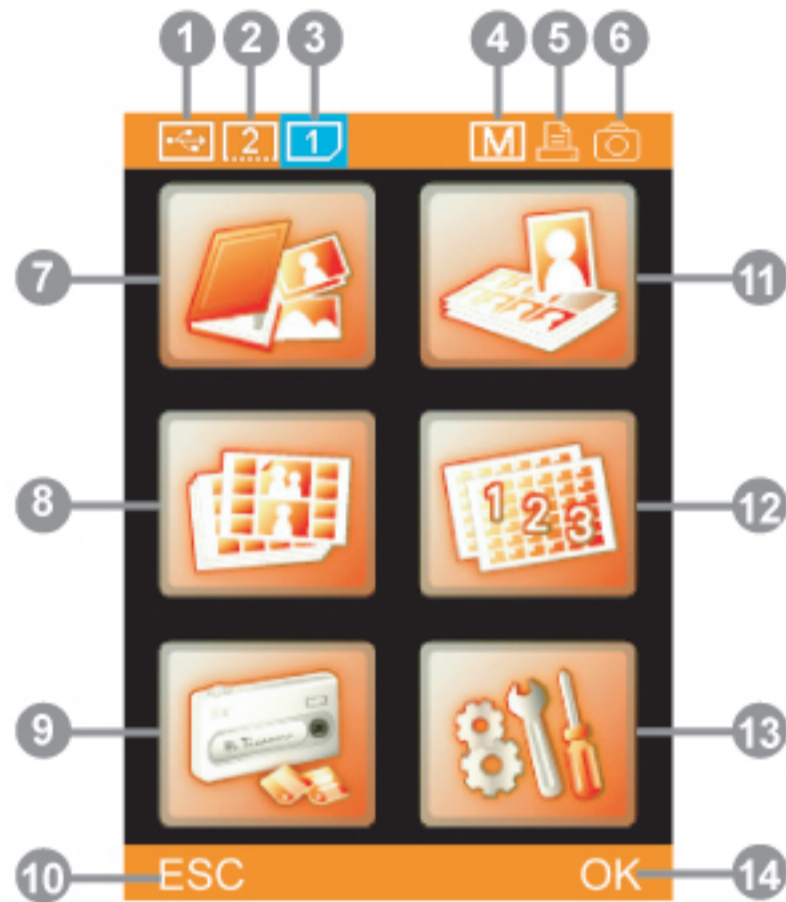

1. Image device from USB host

2. Image device from CF/
Micro Drive

3. Image device from SD / MMC
/ MS / MS Pro

4. Matte effect ON

5. Printing control by S420

6. Printing control by
digital camera

7. PHOTO

8. STICKER

9. IMAGE DEVICE

10. Cancel or go back

11. ID PHOTO

12. INDEX

13. SETUP

14. Confirm or continue

➔ B. Main Function Instruction

▶ Photo



Choose **[PHOTO]**, and press **[OK]** to continue.

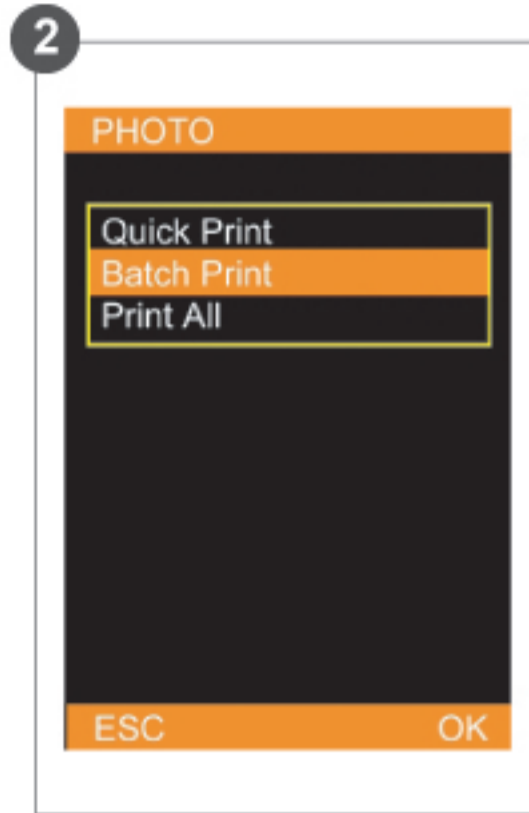

Select **[Batch Print]**, and then press **[OK]** to continue.*



Pick a photo for output, and then press **[OK]** to continue or press **[EDIT]** to start editing. As to how to edit photos, please see Special Function Introduction for detail.

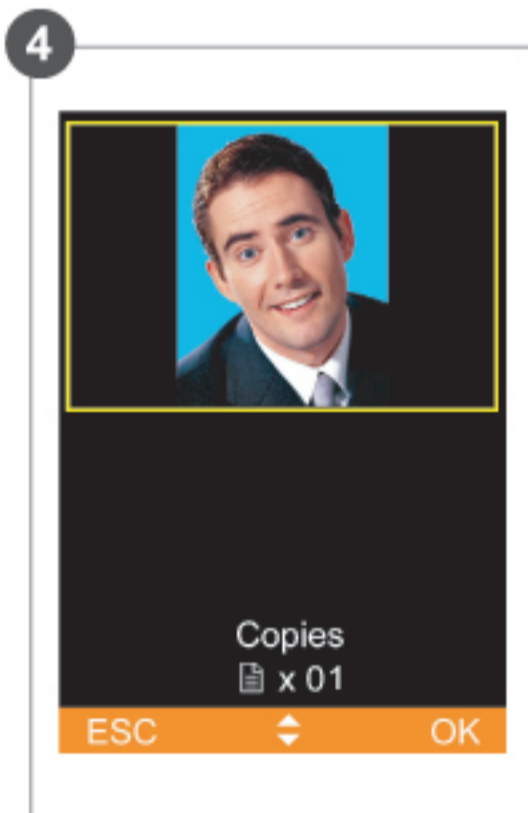

Use directional button to determine the number of copies, and then press **[OK]** to go back image navigator.



The number of copies chosen is displayed at lower right corner. Repeat step 3 and step 4, when everything is done, please press **[PRINT]** to start printing.



S420 is processing the job.

* Note that Quick Print item does not allow users to edit photos selected.

➔ B. Main Function Instruction

▶ ID Photo



Choose **[ID PHOTO]**, and press **[OK]** to continue.

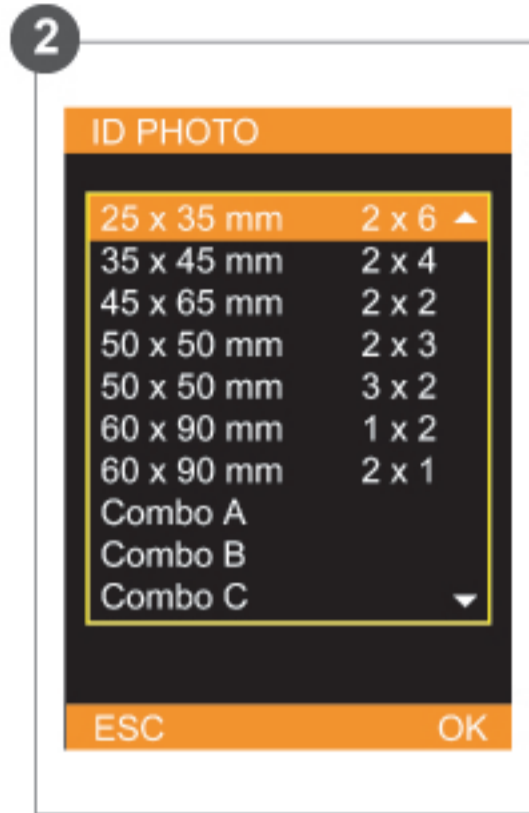

Select an ID format, and then press **[OK]** to continue.

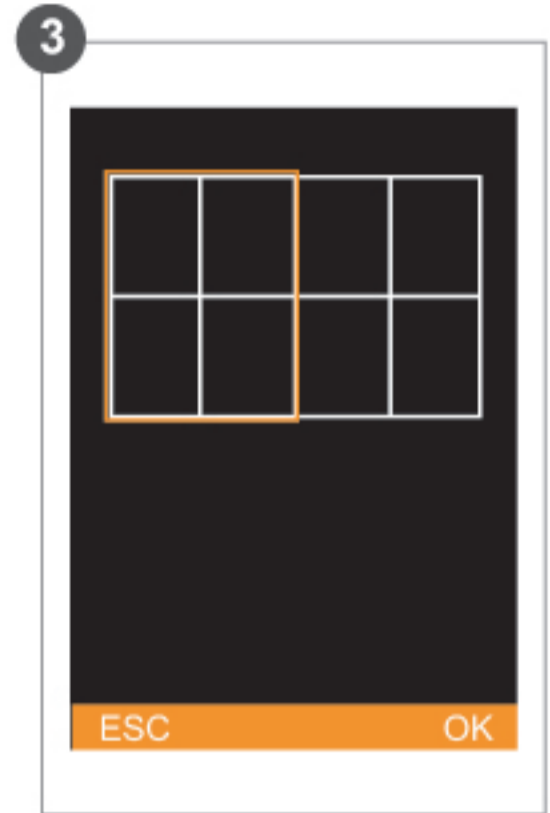

Load images into column highlighted.



Select an image, and then press **[OK]** to continue.

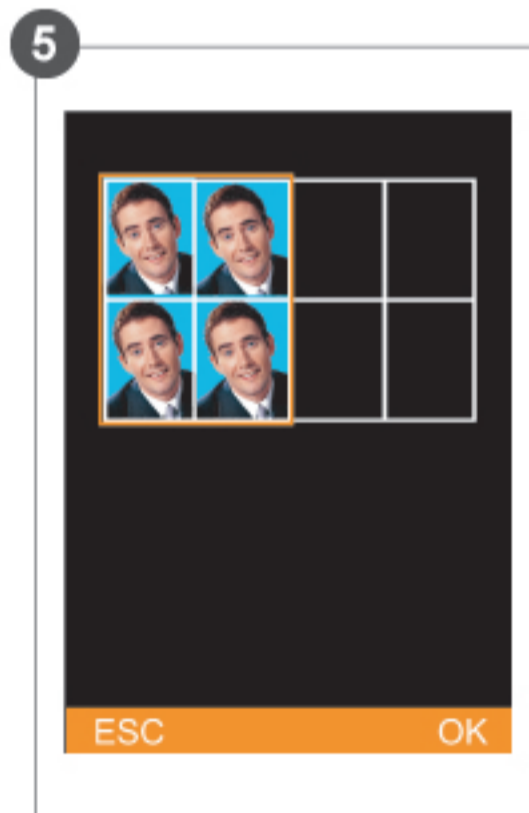

Repeat step 3 and step 4 to finish loading images into the second column.

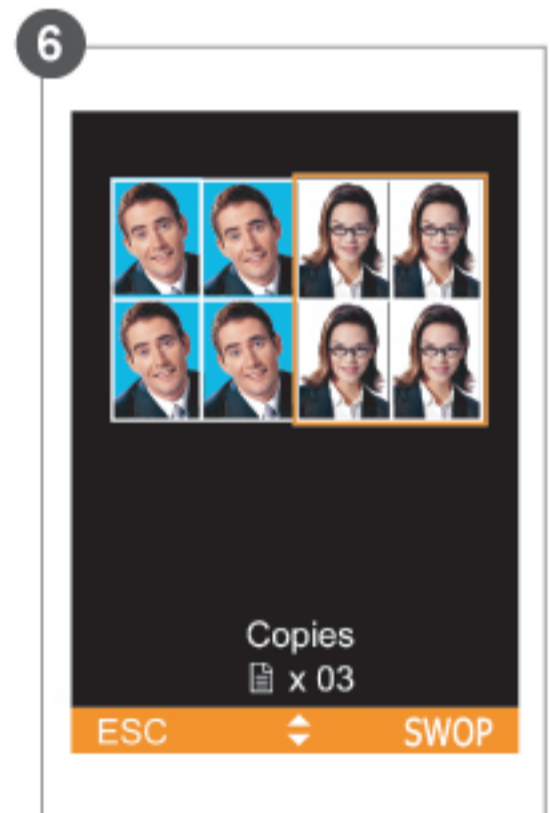

When all columns are filled, please determine the number of copies and press **[PRINT]** to start printing.

➔ B. Main Function Instruction

▶ Sticker



Choose **[STICKER]**, and press **[OK]** to continue.

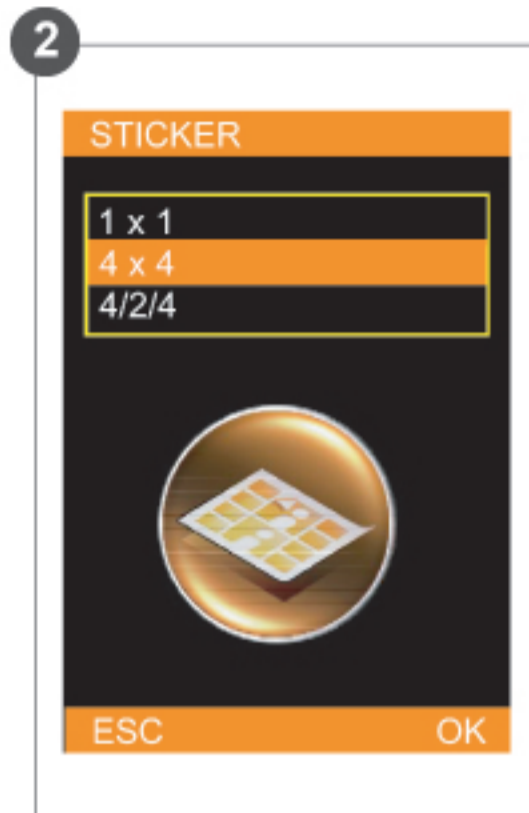

Select a sticker, and then press **[OK]** to continue.

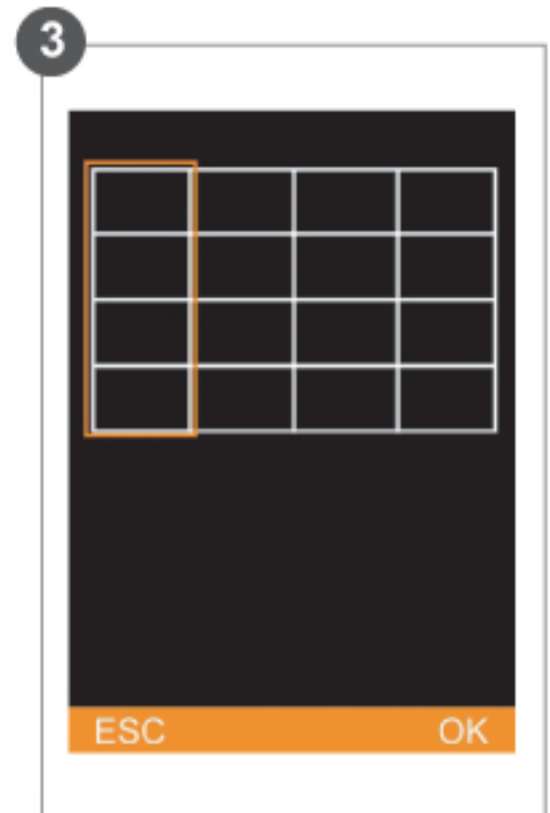

Load images into column highlighted.



Pick an image, and then press **[OK]** to continue.

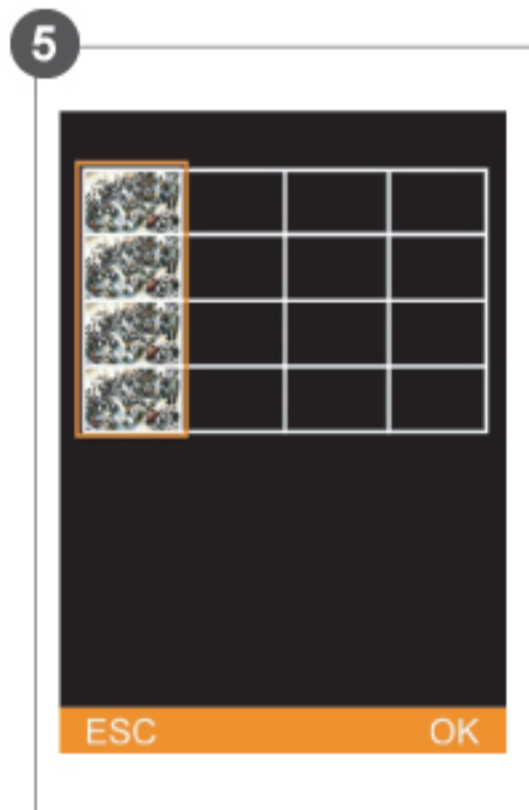

Repeat step 3 and step 4 to continue filling the rest of the columns.

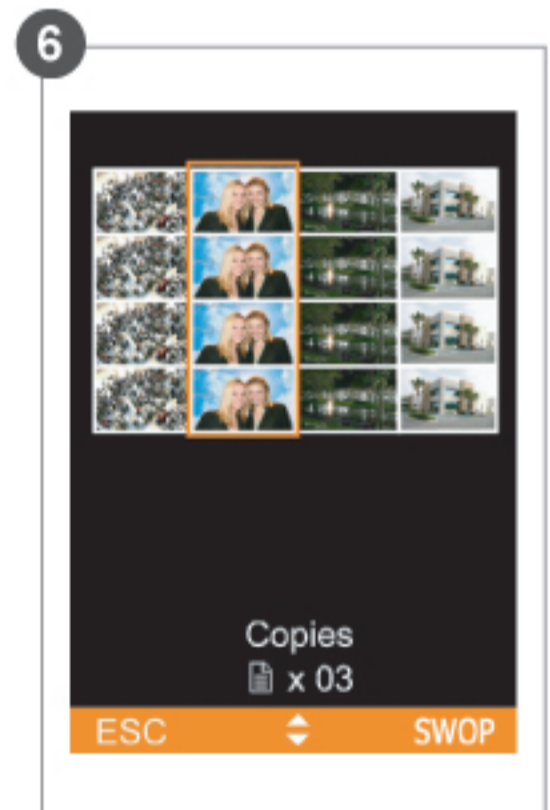

When all columns are filled, please choose the number of copies and press **[PRINT]** to start printing.

➔ B. Main Function Instruction

▶ Index



Choose **[INDEX]**, and press **[OK]** to continue.



Select an index format, and then press **[OK]** to continue.



The printer automatically counts the copy of prints based on the index format. Please press **[OK]** or **[PRINT]** to start printing or press **[ESC]** to go back.

▶ Image-device



Choose **[IMAGE DEVICE]**, and press **[OK]** to continue.

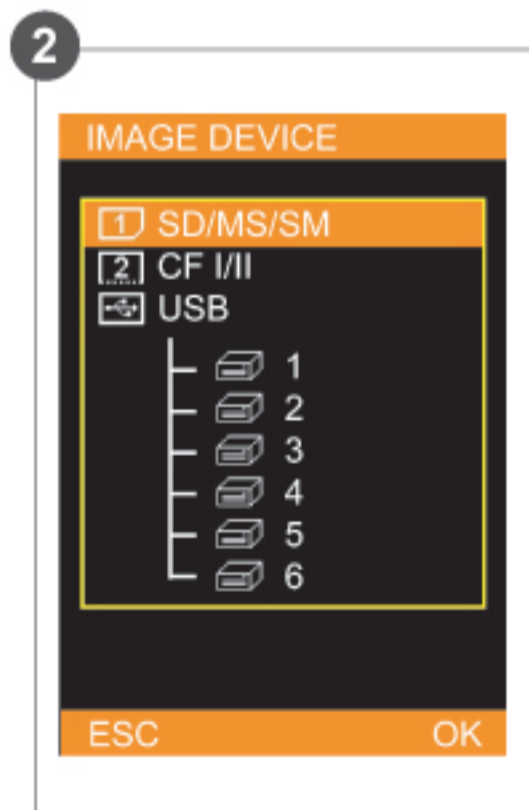

Select an image device as the image source, and then press **[OK]** to save the setting.



The selected image device is displayed in blue.

➔ B. Main Function Instruction

▶ Setup



Choose **[SETUP]**, and press **[OK]** to continue.

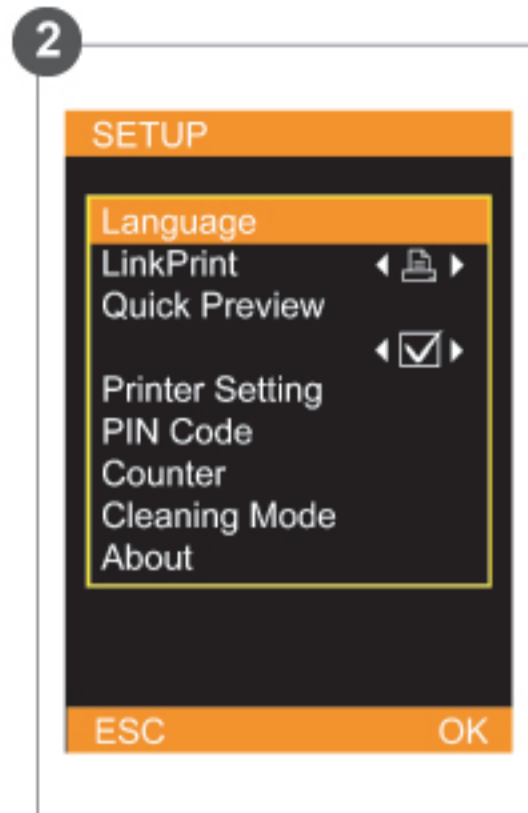

Language: Accessible languages on S420 may vary from region to region.

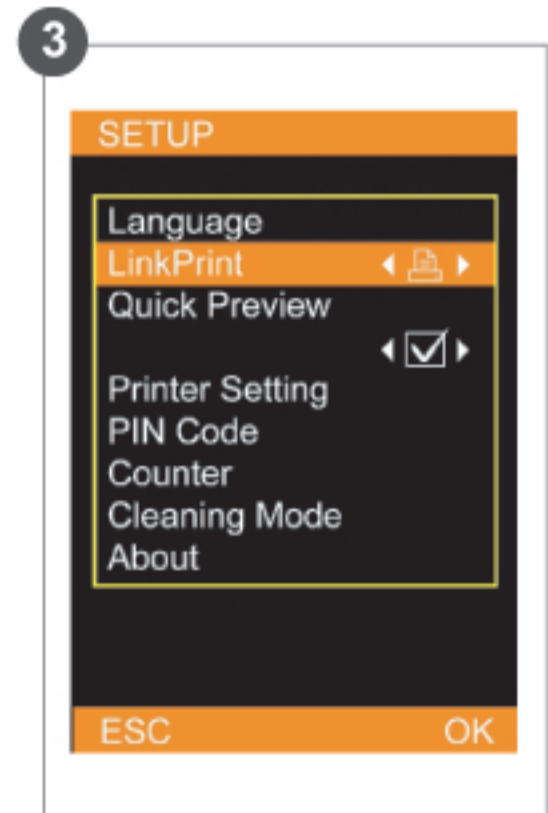

LinkPrint: Users are allowed to control the S420 by using the LCD controller or by using a digital camera.



Quick Preview: Choose between 2 or 6-image navigator. The image navigator can display up to 6-image per page.

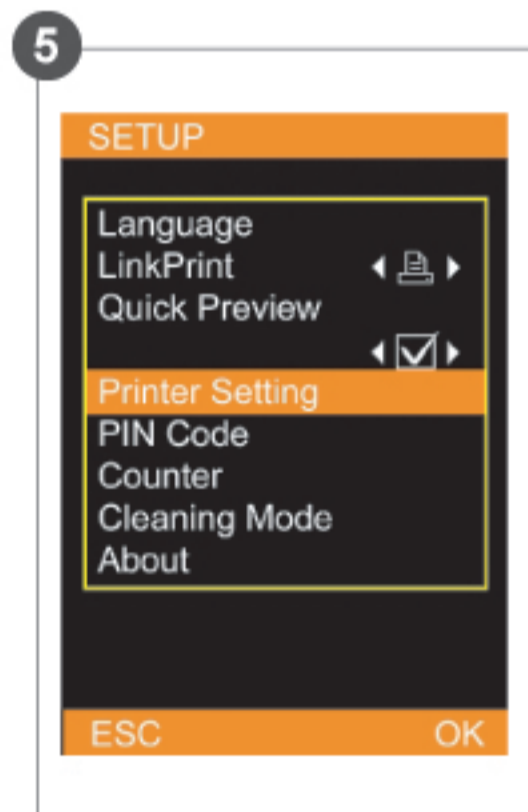

Printer Setting: Allows users to enable or disable Auto-Color and Matte effect, adjust LCD screen, color setting, and print position.

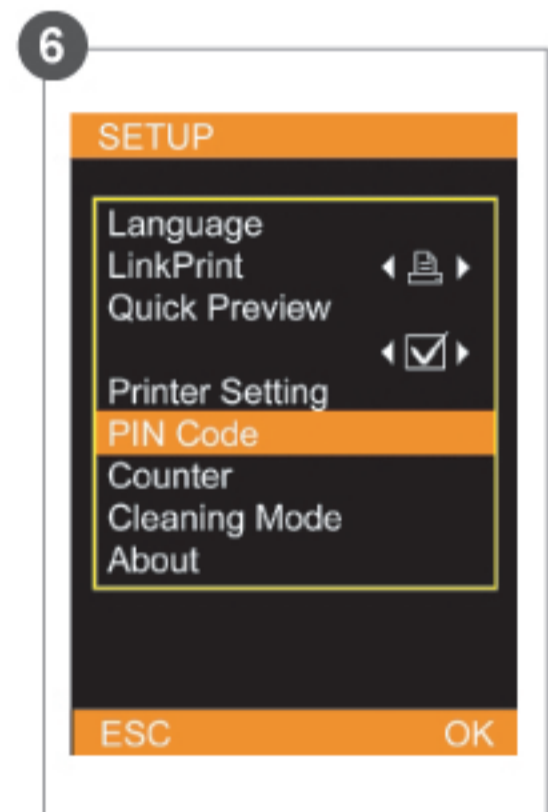

PIN Code: To assure printer security, a PIN code can be set. Once set, the PIN code would have to be entered when the printer reboots or the printing list is being cleared.

➤ B. Main Function Instruction

▶ Setup

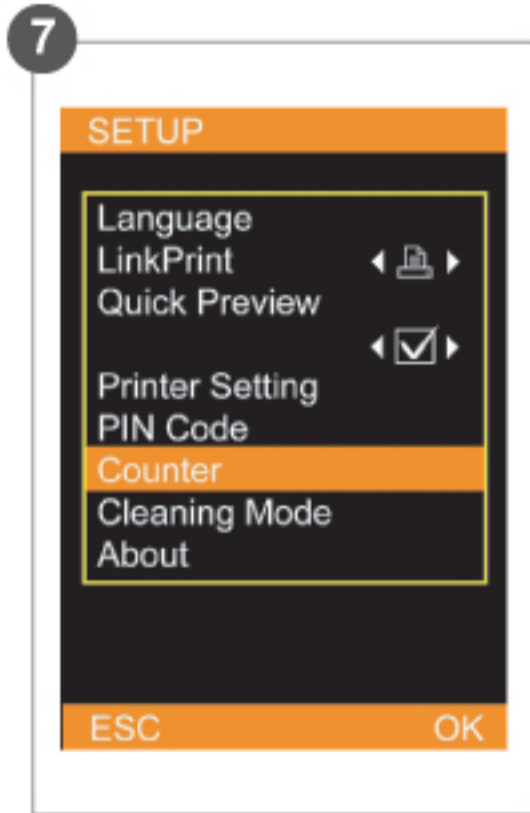

Counter: The user is allowed to reset the counter if the PIN code is correctly entered.

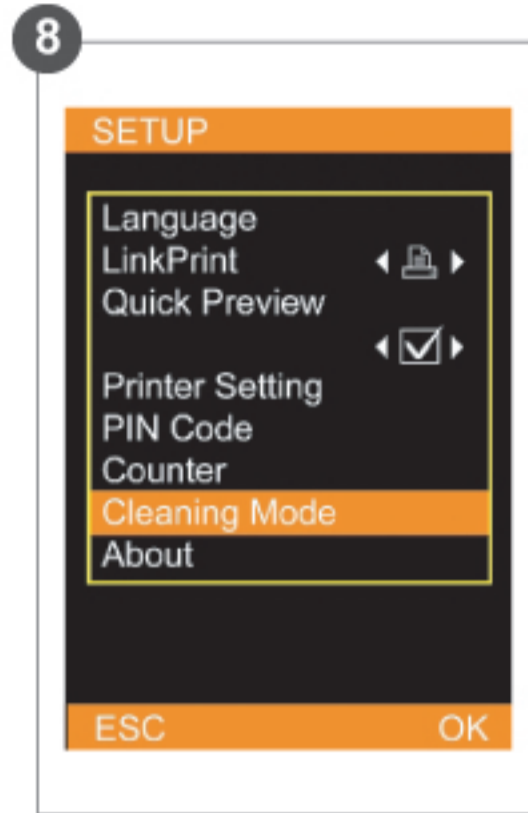

Cleaning Mode: HiTi strongly suggest users to utilize this function frequently to keep the printer in optimal condition.

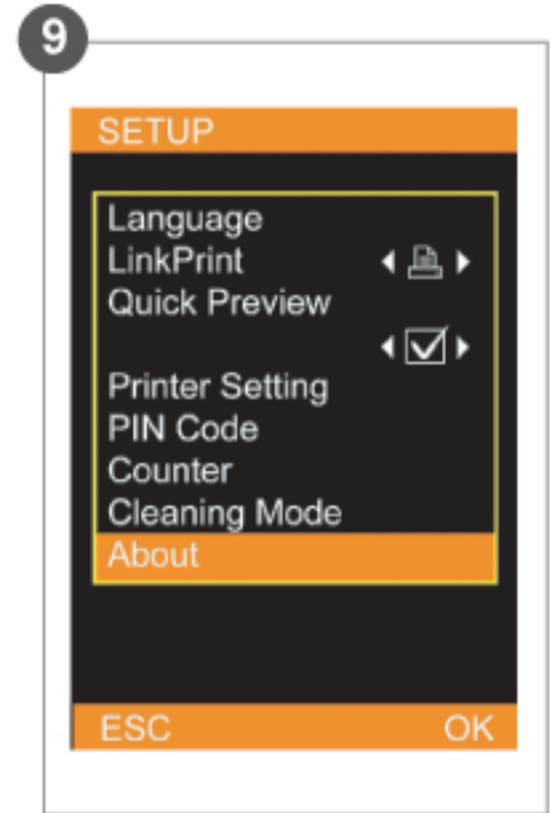

About: It displays information about the current printer firmware, color table version, and controller firmware version.

➔ C. Special Function Instruction

▶ Image adjuster & enhancer



In the image navigator, select an image and press [EDIT] to adjust and enhance the selected image.



Select an image editing function and press [OK] to start editing.



Example on 'Move': Use directional button to adjust the position of output image.



Example on 'Contrast': Use directional button to adjust the contrast of output image.



Example on 'Color R/G': Use directional button to adjust the level of red or green.

➔ C. Special Function Instruction

▶ LCD Adjustment



Choose **[SETUP]**, and press [OK] to continue.

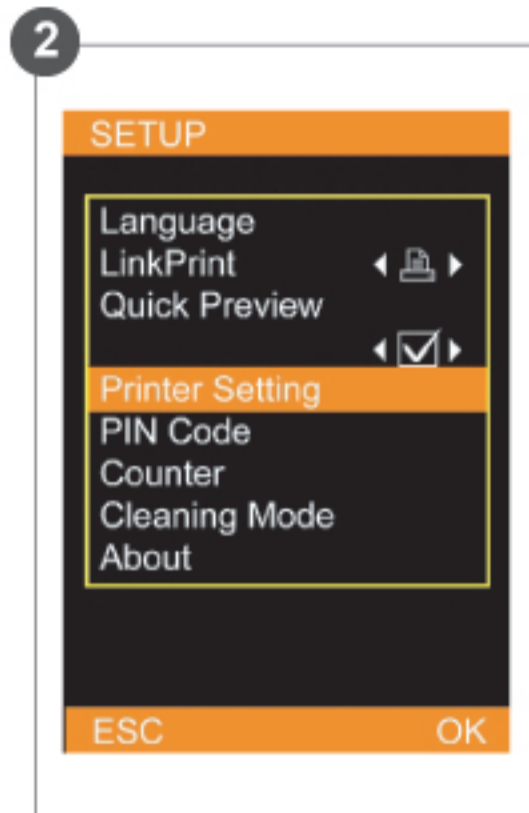

Select **[Printer Setting]** and press [OK] to continue.

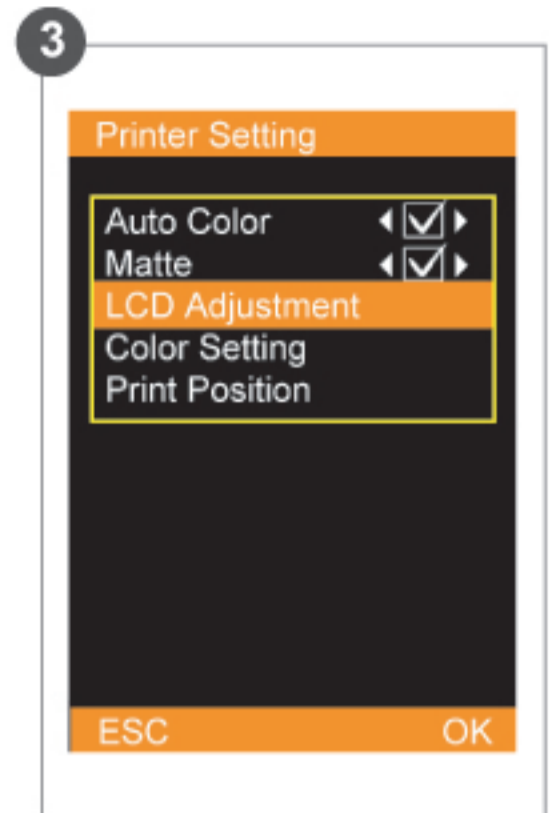

Choose **[LCD Adjustment]** and press [OK] to continue.



Choose an item for LCD adjustment. Note that in LCD adjustment, only the properties of Contrast, Brightness, Color R/G, Color B/Y, Position, and Default Setting can be adjusted.

➔ C. Special Function Instruction

▶ Color Setting



Choose **[SETUP]**, and press **[OK]** to continue.

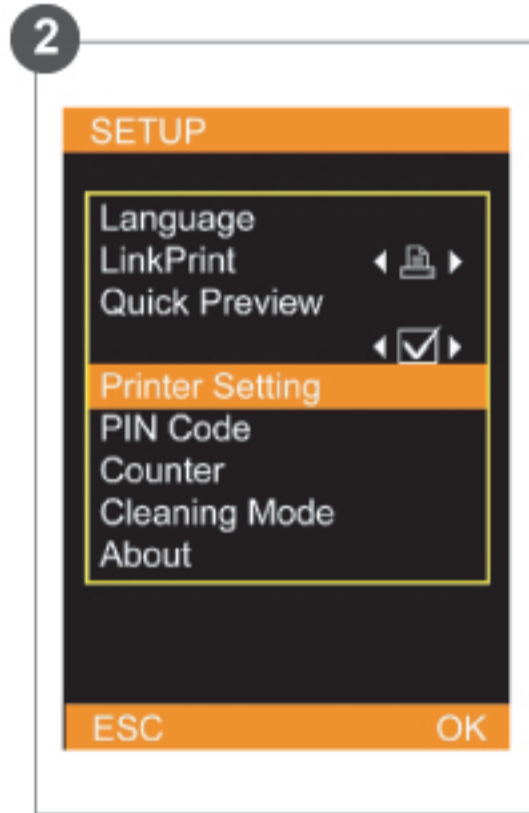

Select **[Printer Setting]** and press **[OK]** to continue.

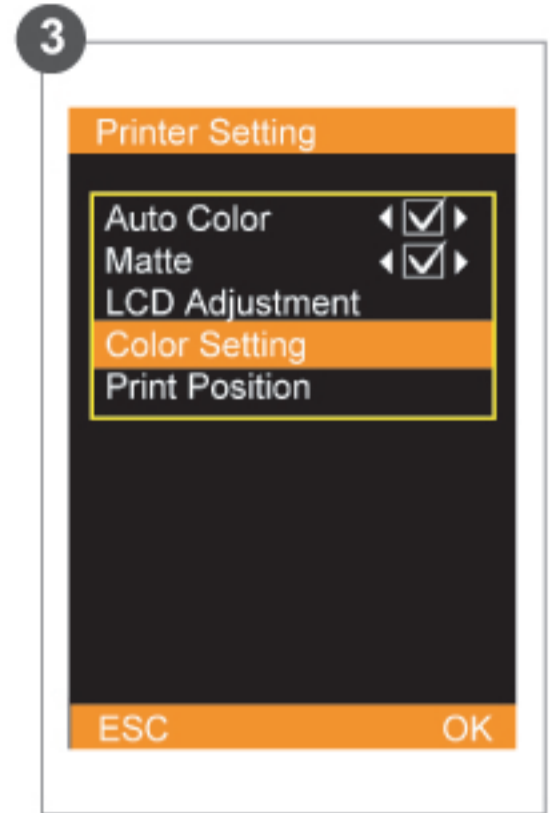

Choose **[Color Setting]** and press **[OK]** to continue.



Select a reference image saved in the memory card for color calibration, then press **[OK]** to continue.



Note that in color setting, only the properties of Contrast, Brightness, Sharpness, Color R/G, Color B/Y, and Position can be adjusted.

➔ C. Special Function Instruction

▶ Print Position



Choose **[SETUP]**, and press **[OK]** to continue.

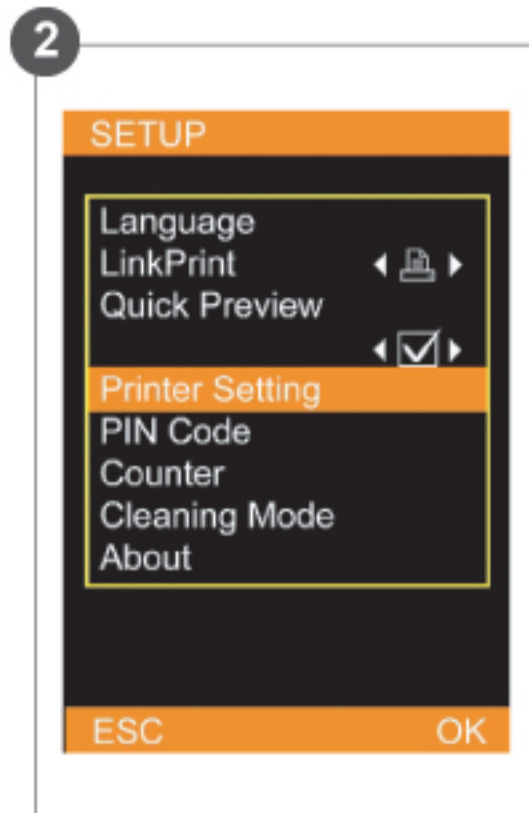

Select **[Printer Setting]** and press **[OK]** to continue.

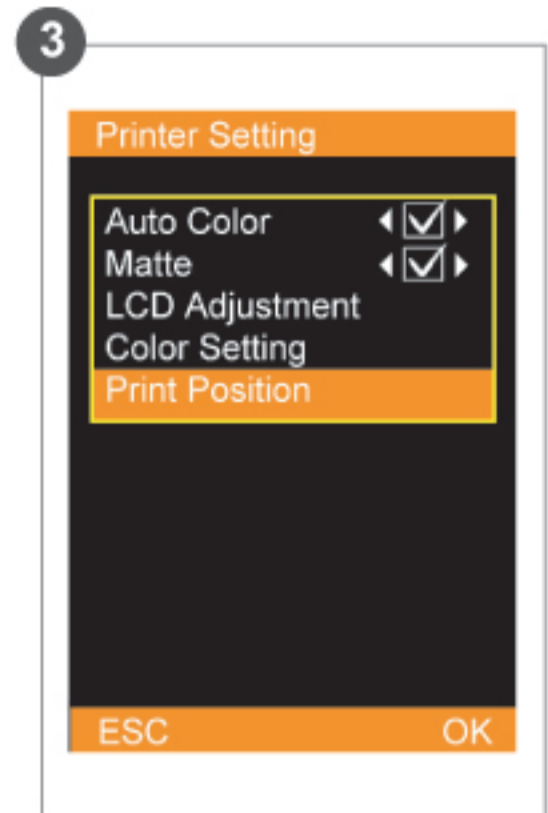

Choose **[Print Position]** and press **[OK]** to continue.



Place 4x4 or 4/2/4 sticker into the paper cassette for calibration reference.

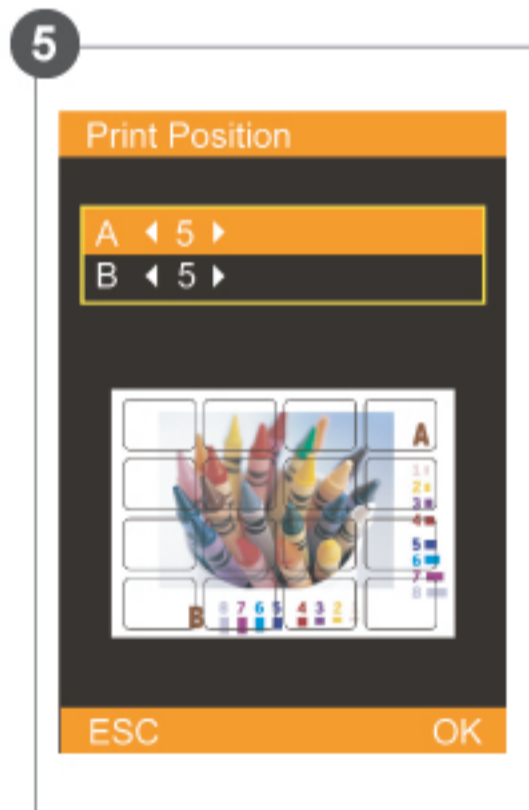

Based on the printout of 4x4 or 4/2/4 sticker, adjust the parameters in the A and B column if needed, then press **[OK]** to save values.

➤ C. Special Function Instruction

▶ Cleaning Mode



Choose **[SETUP]**, and press **[OK]** to continue.

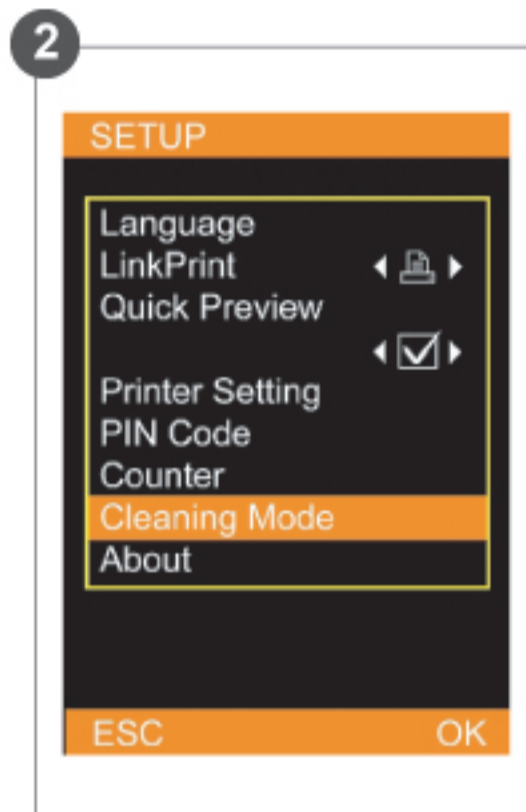

Select **[Cleaning Mode]** and press **[OK]** to continue.

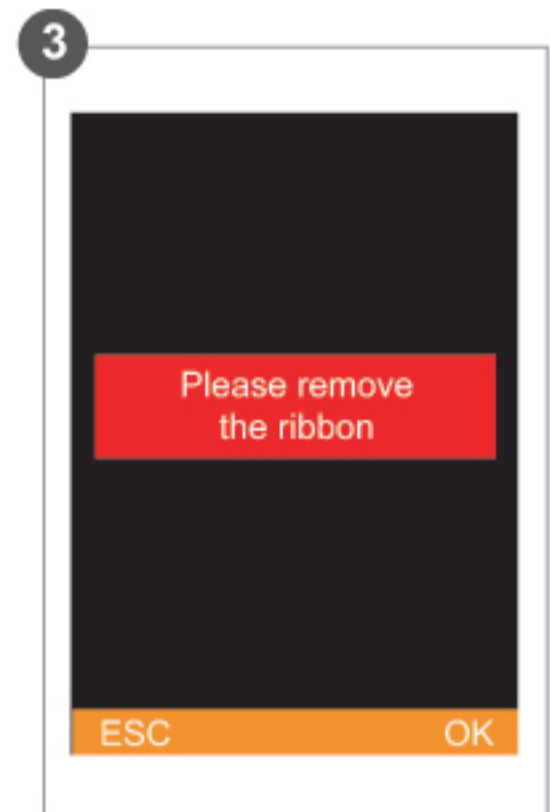

Before the cleaning process begins, please remove the ribbon cartridge from the printer and press **[OK]** to start the cleaning job.

➤ C. Special Function Instruction

▶ Bluetooth Dongle



Plug the Bluetooth dongle into the USB Host Slot.

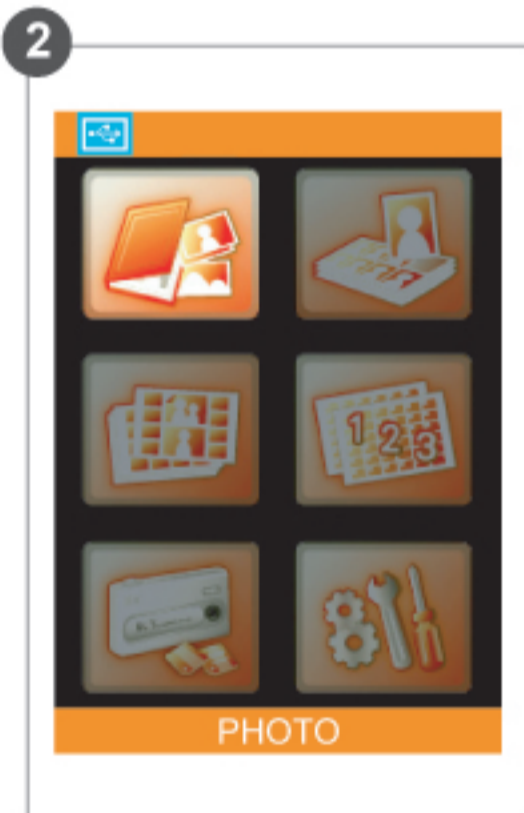

The USB source will be shown in blue color as in ()



Choose [Photo], [Sticker] or [ID Photo] to print the image. *



After choose [Photo], [Sticker] or the ID Layout of [ID Photo], The photo printer will remind you that the blue tooth dongle is working. Select the image and trans the image from the image source to S420.

* Blue tooth dongle function can't be used in the [Index] .

► Connect the PC and Printe

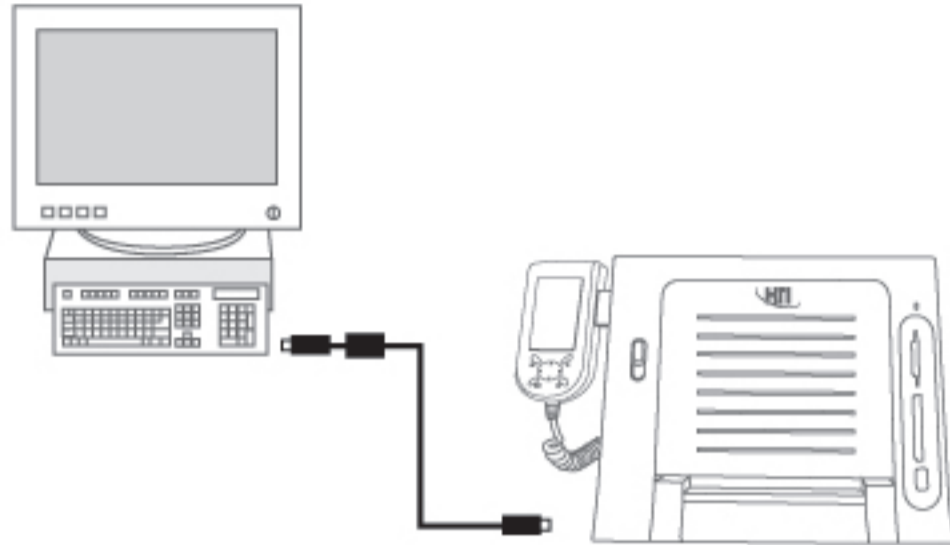

► Install the Printer Driver

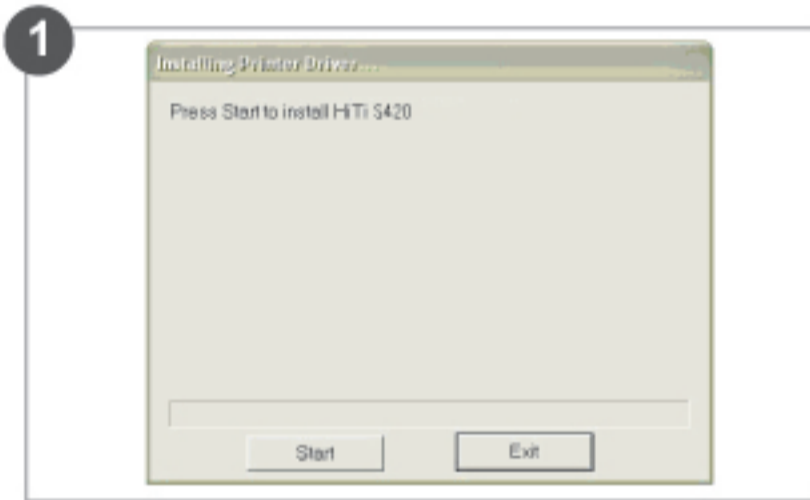

Insert the Mater CD to run the installation.

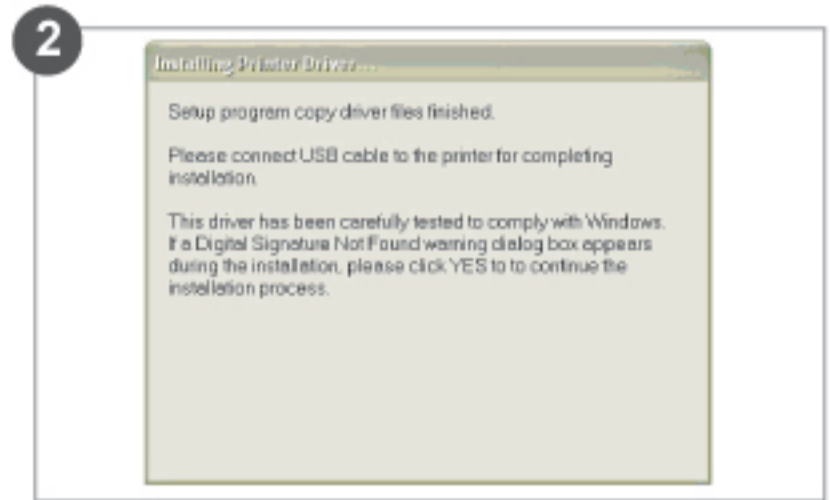

Power on the printer to continue.

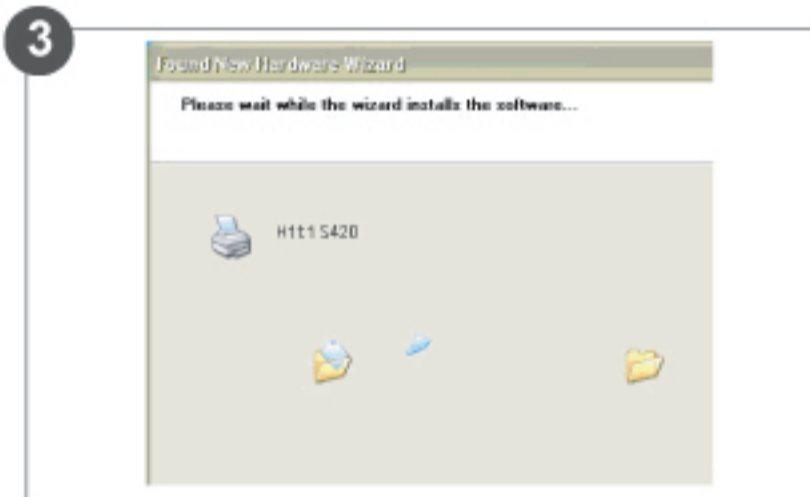

The PC is installing the printer driver.

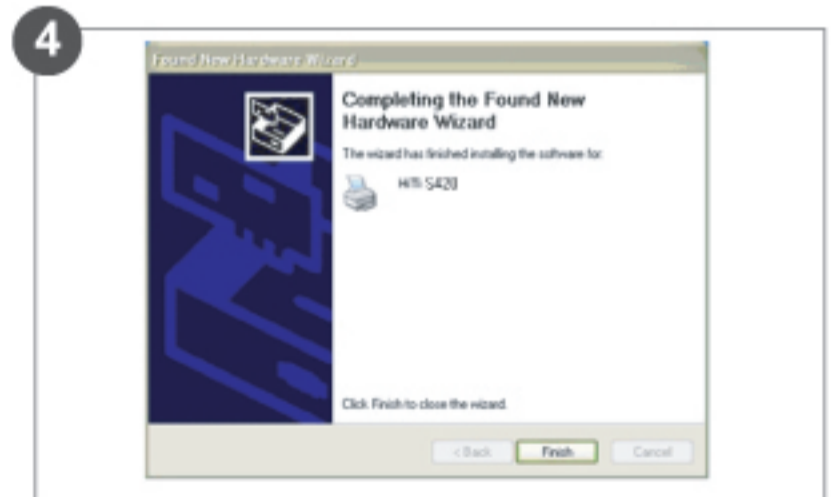

Installation completed.

► Install the IDésirée and PhotoDésirée Deluxe (Please see the user guide of IDésirée and PhotoDésirée Deluxe for detail.)

► Indicator Status

Status	Problem	Troubleshooting
Blinking x 1	Cover Open	► Open and close the ribbon door again.
Blinking x 2	Ribbon Missing	► Re-install the ribbon cartridge
Blinking x 3	Ribbon Out	► Replace the ribbon cartridge
Blinking x 4	Paper Out	► Re-install photo papers and re-check consumables status
Blinking x 5	Paper Jam	► Open the ribbon door and remove the jammed paper.
Blinking x 6	Paper Mismatch	► Please use S420-compatible consumables and check if consumables are correctly placed in the paper cassette.

Note :

- If your problems are not listed above, please contact HiTi service center nearest to you.
- Note that during printer operation, it is normal for the LCD controller to become warm to touch.

► Online Support

For further inquires, please log on to Hi-Touch Imaging technologies website at www.hi-ti.com where you can download free updated drivers, applications, and latest e-templates.

► Global Sites

North America & Canada

Hi-Touch Imaging Technologies (America), Inc.

285 S. Dupont Ave, Suite #104
Ontario, CA 91761
TEL: +1-909-974-0099 FAX: +1-909-974-0011
<http://www.hitouchimaging.com>

Europe

Hi-Touch Imaging Technologies Netherlands B.V.

ESP 206, 5633 AC, Eindhoven, The Netherland
TEL: +31-(0)40-2565166
FAX: +31-(0)40-2903176 & +31-(0)40-2903287
<http://www.hi-ti.nl>

Russia

Hi-Touch Imaging Technologies (Russia) Ltd.

10 Vostochnaya ul, Moscow 115280 Office 3
Russia Federation
TEL: +7-095-580-3208 FAX:+7-095-580-3206
<http://www.hi-ti.ru>

UK & Ireland

Hi-Touch Imaging Technologies (UK) Ltd.

Unit 7, Centurion Court, Brick Close, Kiln Farm
Milton Keynes, MK11 3JB
United Kingdom
TEL: +44(0)1908-266677 FAX: +44(0)1908-266678
<http://www.hi-ti.co.uk>

中国China

Hi-Touch Imaging Technologies (Suzhou)

中国分公司
诚研科技苏州股份有限公司
中国苏州工业园区娄葑镇企鸿路36号C幢
电话: +86-512-8717-1688 传真: +86-512-6760-1186
<http://www.hi-ti.com.cn>

Building C,36# QiHong Road,Suzhou Industrial
Park, Jiangsu Province, PRC
Tel:+86-512-8717-1688 Fax:+86-512-6760-1188
<http://www.hi-ti.com.cn>

Head Quarter - Taiwan

Hi-Touch Imaging Technologies

營運總部
誠研科技股份有限公司
台北縣板橋市雙十路三段 31 號 3 樓
電話: +886-2-8258-3060 傳真: +886-2-8258-3062
<http://www.hi-ti.com.tw>

3F, No.31, Shuang-Shih Rd. Sec.3, Pan-Chiao City,
Taipei County 220, Taiwan
Tel: +886-2-82583058 Fax: +886-2-82583062
<http://www.hi-ti.com.tw>



© 2007 Hi-Touch Imaging Technologies.

All rights reserved, HiTi.

<http://www.hi-ti.com>

P/N:39.P2000.E01