



THE HUBSAN X4 FPV BRUSHLESS

Hubsan FPV X4 Brushless

V1.0 2015.01

Please read the instruction manual carefully!

IMPORTANT SAFETY NOTES





OPERATION:

Be extremely careful and responsible when using the FPV X4 . Small electronic components can be damaged by crashing or by dropping the X4 in water. To avoid further damage to the unit, people, or property, damaged spare parts should be replaced in time.

Flight:

- Take responsibility for your safety and the safety of others when you fly the X4 !
- Do not fly the X4 in crowded places. It needs plenty of space to operate.
- Do not fly in bad weather.
- Never try to catch the X4 while it is in flight.
- This model is intended for experienced pilots age 14+.
- Power off the X4 after flight, to prevent the propellers from causing injuries.
- Always remove the battery after you stop flying to avoid injuries from accidentally powering on the motors.
- Always use great caution to protect yourself when near the propellers. The flight system will start after
- power on regardless of the transmitter signal. The high speed propellers are very dangerous. Power off the X4 after every flight or the propellers may still rotate and cause injury.

SYMBOL EXPLANATION

 No operating  Important Notice  Instruction  Explanation, reference

USAGE ADVICE

Hubsan provides you with two files

1. "Disclaimer"
2. "User Manual"

Please view the instruction videos and Disclaimer first, then read the manuals.

LIPO BATTERY SAFETY NOTES

If the X4 doesn't in use for a week or more, please store the battery approximately 50% charged to maintain battery performance and battery life.



SAFETY ADVISORY NOTICE Lithium-Polymer (LiPo) Batteries

LiPo batteries are different from conventional batteries in that their chemical contents are encased in a relatively lightweight foil packaging. This has the advantage of significantly reducing their weight, but does make them more susceptible to damage if roughly or inappropriately handled. As with all batteries, there is a risk of fire or explosion if safety practices are ignored:

- Charge and store LiPo batteries in a location where a battery fire or explosion (including smoke hazard) will not endanger life or property.
- Keep LiPo batteries away from children and animals.
- Never charge the LiPo battery that has ballooned or swelled.
- Never charge the LiPo battery that has been punctured or damaged.
- After a crash, inspect the battery pack for signs of damage. Discard in accordance with your country's recycling laws.
- Never charge the LiPo battery in a moving vehicle.
- Never overcharge the LiPo battery.
- Never leave the LiPo battery unattended during recharging.
- Do not charge LiPo batteries near flammable materials or liquids.
- Ensure that charging leads are connected correctly. Reverse polarity charging can lead to battery damage, fire, or explosion.
- Have a suitable fire extinguisher (electrical type) OR a large bucket of dry sand near the charging area. Do not try to extinguish (LiPo) battery fires with water.
- Reduce risks from fire/explosion by storing and charging LiPo batteries inside a LiPo charge sack.
- Protect your LiPo battery from accidental damage during storage and transportation. (Do not put battery packs in pockets or bags where they can short circuit or can come into contact with sharp or metallic objects.)
- If your LiPo battery is subjected to a shock (such as a crash), place it in a metal container and observe for signs of swelling or heating for at least 30 minutes.
- Do not attempt to disassemble, modify, or repair the LiPo battery.

INDEX

IMPORTANT SAFETY NOTES	02	6. START TO FLY	12
SYMBOL EXPLANATION	02	6.1 The Flight Environment	13
USAGE ADVICE	02	6.2 Check Before Flying	13
LIPO BATTERY SAFETY NOTES	03	6.3 The Link Of The Transmitter And The Quad Copter	13
INDEX	04	6.4 Compass Calibration	13
INTRODUCTION	05	7. START/ STOP THE MOTORS	14
1 ITEMS INCLUDED IN THE BOX	05	8. BASIC FLIGHT	14
2 QUAD COPTER	06	9. ADVANCED PERFORMANCE SETUP	16
2.1 Flight Control System Introduction	06	9.1 Reversing channel setup	16
2.2 Quad Copter Motor Led Indicator	06	9.2 Sensitivity set up	16
3 QUAD COPTER BATTERY	07	9.3 Set manual setup	16
3.1 Introduction	07	9.4 Headless Mode	17
3.2 Install the Battery	07	9.5 Follow Me Mode	17
3.3 Charging	07	9.6 RTH MODE	18
4. PROPELLER	08	9.7 FAILSAFE MODE	18
4.1 Introduction	08	10 OPTIONAL TRANSMITTER	19
4.2 Assembly	08	H501S TROUBLESHOOTING	20
4.3 Disassembly	08	SCHEMATIC DIAGRAM	21
5. Transmitter	09	FCC Information	22
5.1 Input key function	10		
5.2 Install the TX battery	11		
5.3 Transmitter calibration	11		
5.4 Frequency selectable 5.8Ghz	12		







INTRODUCTION

Thank you for buying the HUBSAN quad copter. The X4 quadcopter is designed as an easy-to-use, full-featured RC model, capable of hovering, fast forward and aerobatic flight maneuvers. Please read the manual carefully and follow all the instructions. Be sure to retain the manual for future reference, routine maintenance and tuning.

 **FPV:** First Person View Function enables you to experience every live moment of the flight from the quad's view.

1. ITEMS INCLUDED IN THE BOX

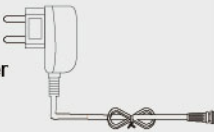
Check all the items in the box before use.

S/N	Part Name	Photos	Q'ty	Remarks
1	Quad copter		1PC	Equipped with smart flight controller,GPS and compass
2	Propellers		8PCS	Propeller A 4pcs, Propeller B 4pcs
3	Transmitter		1PC	FPV Transmitter, equipped with 4 X AA battery (Not included)
4	7.4V LiPo battery		1PC	For quad copter
5	LiPo Balance charger		1PC	Use to recharge the LiPo battery
6	LiPo Charger Adapter		1PC	110-240V
7	Assistant wrench		1PC	For removing propellers
8	User Manual		2PCS	Disclaimer Hubsan X4 Instruction Manual

2. QUAD COPTER

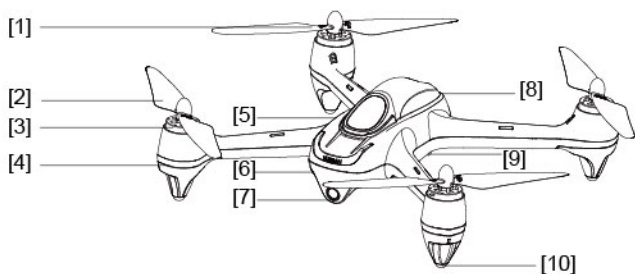

[1] Propeller B [2] Propeller A [3] Motor [4] Motor LED indicator [5] Upper body shell
[6] Lower body shell [7] 1080P HD Camera [8] Battery compartment [9] TF card plug
[10] Rubber feet

2.1 FLIGHT CONTROL SYSTEM INTRODUCTION

The quad copter's flight control system with a built-in GPS and compass that is used to control the quad copter's functions such as ascend and descend, pitch and roll.

Modules on flight control system	Function
Main Control Module	CPU of the flight control system, connects to all the modules for central control processes.
IMU Module	Includes inertial sensor, stabilizes flight; includes a barometer to measure the flight altitude.
GPS & Compass Module	Position hold and Navigation.
LED indicator	Indicating the flight control system's condition.

2.2 QUAD COPTER MOTOR LED INDICATOR

Indicator Status:

1. Power on: 4 LED indicators blink in white simultaneously
2. Compass calibration: 4 LED indicators blink in red cycling
3. Flight : 4 LED indicators blink simultaneously, 2 front LED indicators keep blink in white and the 2 back LED indicators blink colors are as following:
 - 1) Standard: blink in yellow
 - 2) GPS : blink in green
 - 3) HOME: blink in blue
 - 4) Battery in low capacity: blink in red

3. QUAD COPTER BATTERY

3.1 INTRODUCTION

The quad copter battery is a rechargeable lipo battery with 2700mAh capacity and 7.4V voltage. The battery should only be charged with the HUBSAN charger.

3.2 INSTALL THE BATTERY

Push the battery into the battery compartment correctly and connect the battery plugs in correct polarity. Close the battery compartment cover.

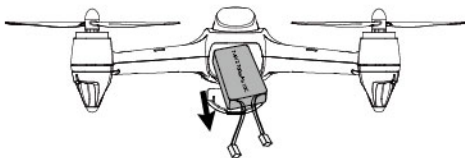

3.3 CHARGING

Connect the battery to the balance charger and wall charger. The balance charger indicator is in solid red when charging and turns solid green when the battery is fully charged. It takes around 150 minutes to finish the complete charge.

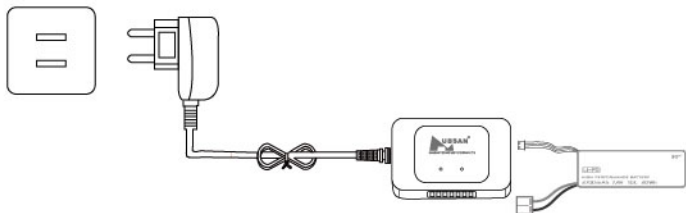







Pls fully charge the batteries to avoid loss of control due to low voltage

4. PROPELLER

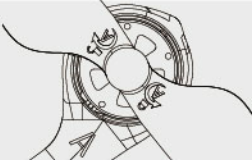
4.1 INTRODUCTION

The quad copter uses the 7.3-inch propellers which are marked by A and B. Damaged propellers should be replaced in time to maintain the good performance.

	propeller A	propeller B
Diagram		
Installation Position		
Symbol explanation	 LOCK: In this direction, tighten the propeller onto the motor shaft  UNLOCK: In this direction, remove the propeller from the motor shaft	

4.2 ASSEMBLY

Assemble the propellers on the motor threads that marked the same letter and lock them according to the instruction way.

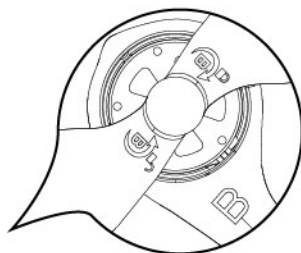
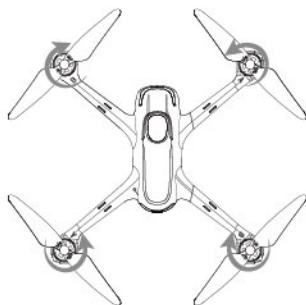

4.3 DISASSEMBLY

Deadlock the motor with the U wrench.
Remove the propeller by rotating it counter-clockwise to unlock.

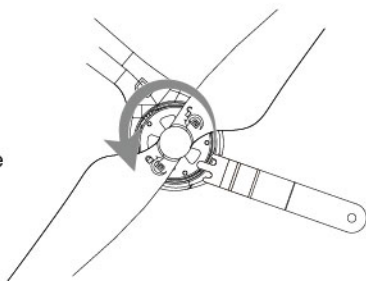

- ⚠ The propellers are designed to tighten automatically. Do not overtighten the screws and do not use any type of screw glue.
- Make sure that the A and B propellers are installed correctly. The X4 will not fly if propellers are improperly installed.
- Wear gloves when install the propellers to avoid scratches from the thin, sharp propellers.

5 TRANSMITTER

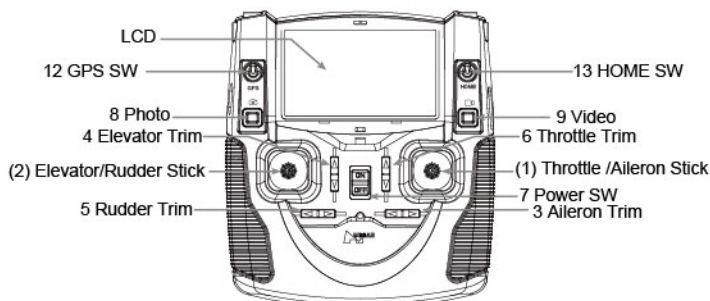
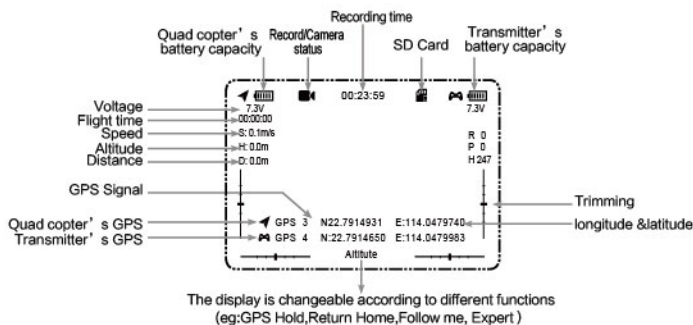

(MODE 1)

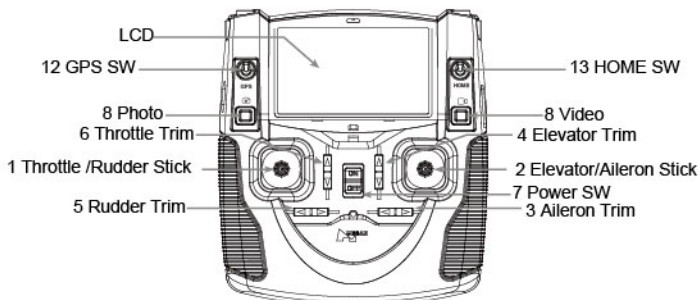
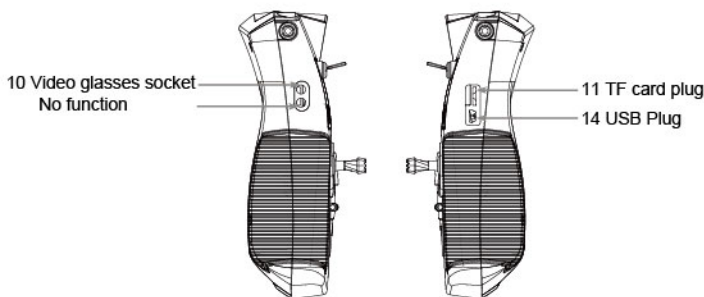

(MODE 2)

5.1 INPUT KEY FUNCTION

S/N	Mode/ Control	Function
(1)	MODE 1 Throttle/Aileron Stick	Push the stick forward or backward and the quadcopter will ascend or descend; Push the stick left or right and the quadcopter will fly left or right.
(2)	MODE 1 Elevator/Rudder Stick	Push the stick forward or backward and the quadcopter will fly forward or backward; Push the stick left or right and the quadcopter will rotate in counter clockwise or in clockwise.
1	MODE 2 Throttle/ Rudder Stick	Push the stick forward or backward and the quadcopter will ascend or descend; Push the stick left or right and the quadcopter will rotate in counter clockwise or in clockwise
2	MODE 2 Elevator /Aileron Stick	Push the stick forward or backward and the quadcopter will fly forward or backward; Push the stick left or right and the quadcopter will fly left or right
3	Aileron Trim	Aileron trim adjusts for left and right drift.
4	Elevator Trim	Elevator trim adjusts for forward and backward drift.
5	Rudder Trim	Rudder trim adjusts for drift of left and right rotation or yaw.
6	Throttle Trim	Throttle trim normally left at neutral. The lower trim turns LEDs on and off.
7	Power Switch	Push to ON to turn on the transmitter. Push to OFF to turn off.
8	Photo	Press the photo button to shoot a photo;
9	Video	Press video button and start the record and press again to stop
10	Video glasses socket	Connect Hubsan video glasses, which not included and need purchase
11	TF card plug	The TF card can be inserted into the card plug on the TX or the quad copter. (Recommend on the quad copter)
12	GPS SW	Push the switch up, the built-in GPS will calculate the quad copter's position and height and help to lock the quad copter in a stable hover (ONLY FOR OUT DOOR)
13	HOME SW	Push the switch up, the quad copter will return to the takeoff point automatically (ONLY FOR OUT FOOR)
14	USB plug	Only for engineer to upgrade the software, please do not use it to connect computer

5.2 INSTALL THE TX BATTERY

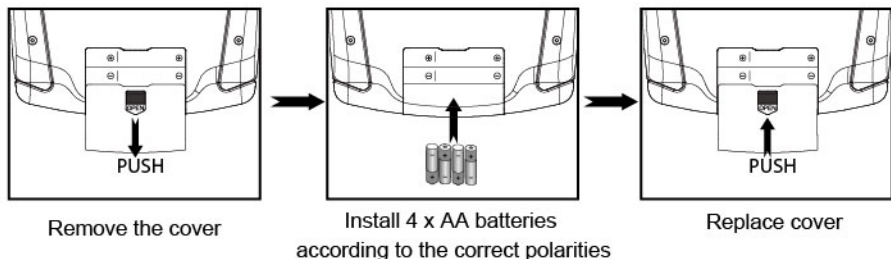

- Do not mix old and new batteries
- Do not mix different types of batteries
- Do not charge non-rechargeable battery.

5.3 TRANSMITTER CALIBRATION

Mode 2: Push both sticks to the upper left position and power on the transmitter simultaneously, rotate both sticks twice. Long press any trim until the LED on the transmitter turns in solid green, indicating a successful calibration.

Mode 1: Push the left stick to the upper left position and right stick to the upper right position and power on the transmitter simultaneously, rotate both sticks twice. Long press any trim until the LED on the transmitter turns in solid green, indicating a successful calibration.

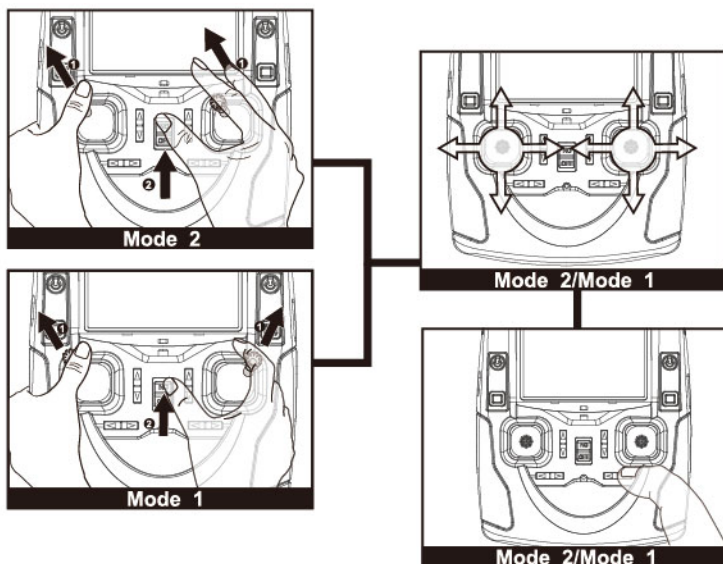

The transmitter's mode is changeable according to the above way.

Notice:

1. The video will stop when the transmitter battery is low.
2. When the SD card is full, it can't record anymore and the screen will display "SD Full".
3. It is best to use a 4G+, and class 4+ SD card. Format in the transmitter before use.
4. When the power on the transmitter is low, the red LED will blink quickly and the LCD screen will turn black. The transmitter and X4 will not bind if the batteries are low. Please replace with new batteries.
5. If the batteries in the transmitter are running low whilst flying the X4, you will still have control. Please land the X4 and then replace batteries in the transmitter.
6. The Transmitter can only use 2S Lipo batteries, 4XAA batteries or NI-MH AA batteries, other batteries will damage the Transmitter.

5.4 FREQUENCY SELECTABLE 5.8GHZ

The transmitter will automatically find the best frequency to ensure a quality live video transmission. In case any interference, please re-select the frequency from 5730MHZ to 5845MHZ to get a better video transmission.

Pull the throttle stick to the lowest position and long press the Elevator stick to enter into the MAIN MENU interface. Push the Elevator stick up/down to select "5.8G Frequency", push the stick right to enter into the "5.8G frequency" interface, select a matched frequency.

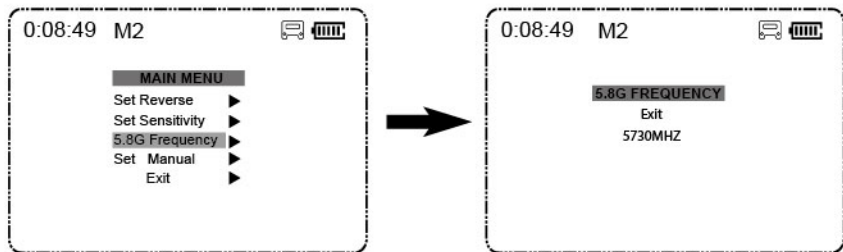

6. START TO FLY

When assembly is finished, please allow yourself to get some practices or trainings before the first flight. Flight simulators are highly recommended. Please fly your X4 in a safe and open place.

6.1 THE FLIGHT ENVIRONMENT

- (1) The flying area should be open and without tall buildings or other obstacles; the steel structure within building would interfere with the compass.
- (2) DO NOT fly in bad weather such as strong wind, heavy snow, rain or foggy day.
- (3) Keep away from barriers, people, power cables, trees, and other obstructions.
- (4) Do not fly near radio towers or airports.
- (5) The X4 control system will not work properly at the South or North Pole
- (6) DO NOT fly in restricted areas and please follow your country's laws and regulations.

6.2 CHECK BEFORE FLYING

- (1) Make sure the batteries of the transmitter and the X4 are fully charged.
- (2) Make sure the propellers are installed correctly and tightly.
- (3) Make sure the memory card is installed and has sufficient room remaining for recording.
- (4) Make sure all motors work properly.

6.3 THE LINK OF THE TRANSMITTER AND THE QUAD COPTER

The transmitter and the quad copter are linked before delivery. Should you change the transmitter or the quad copter, re-linkage is required.

Procedures:

1. Press the photo function button and turn on the transmitter simultaneously, waiting for the initialization. "System initialize" letters display on the LCD
2. Release the photo function button. "Bind to Plane" letters display on the LCD.
3. Power on the quad copter, place it very close to the transmitter, the linkage matched indicating by a "beep" sound
4. Should the linkage not match, please repeat the above steps.

6.3 COMPASS CALIBRATION

Compass calibration is required before the first time flight otherwise the system may not work properly. The compass is very sensitive to electromagnetic interference which can cause abnormal compass data and lead to poor flight performance or even flight failure. Regular calibration enables the compass in optimum performance

-
- ⊗ Do not calibrate the compass in a strong magnetic field
 - Do not carry ferromagnetic materials with you while calibrating the compass, such as keys, cell phones.
-

6.4 CALIBRATION PROCEDURES

Please carry out the calibrating procedures before the first flight.

- 1.) Hold the Throttle Stick fully down, flip the GPS switch quickly until the transmitter displays "Calib compass 1"
- 2.) Rotate the X4 in clock-wise until the LCD screen displays "Calib compass 2"
- 3.) Put the X4 nose down and rotate it in counter clock-wise until the "Calib compass 2" disappears

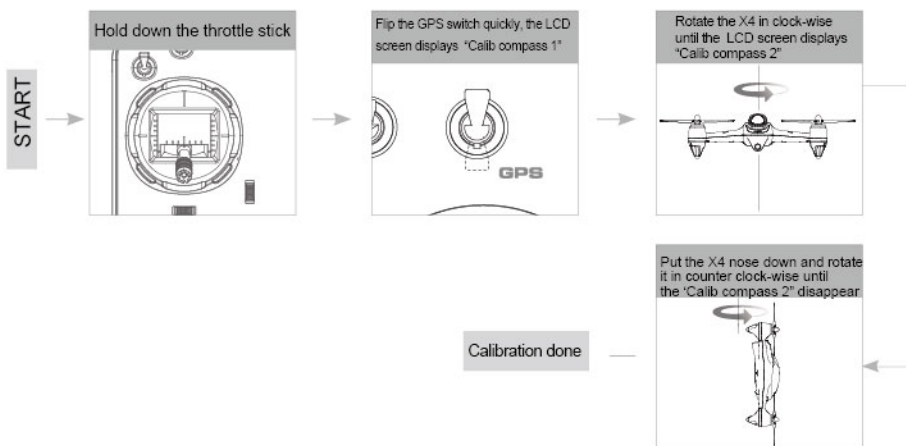

7. START/ STOP THE MOTORS

Start the motors

Method : Pull the two sticks as the picture shows. Release them after the motors start.

Stop the motors

Method : Pull the sticks again, as seen in the picture, and release them after the motors stop.

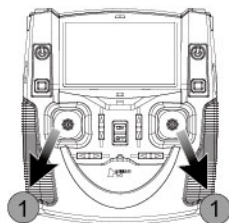

⊗ Do not stop the motors during the flight to avoid any crash.



💡 Push the sticks as slightly as you can. Release the sticks after the motors start or stop.

8. BASIC FLIGHT

The operation mode for the transmitter is Mode 1 or Mode 2. The manual will use Mode 2 as an example to illustrate the transmitter's operation.

- The stick return to the center: The transmitter's stick is in the center.
- Stick's rudder offset: The offset of the transmitter sticks from the center.

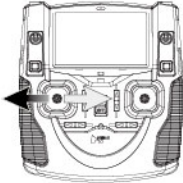
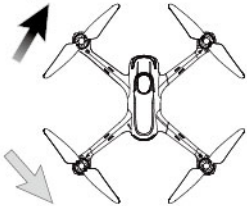
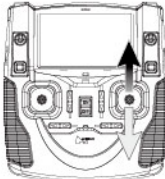
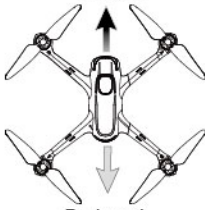
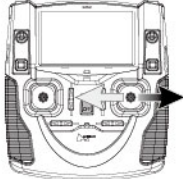
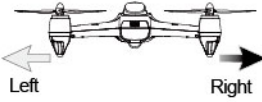
Transmitter (Model 2)	X4	Control Ways
		<p>The throttle stick controls the ascent and descent .</p> <p>Push up the stick and the X4 will ascend.</p> <p>Pull down the stick and the X4 will descend.</p> <p>When the stick in center, the X4 will hover and hold its altitude automatically .</p>

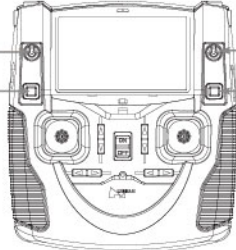
	<p>Right rotation</p>  <p>Left rotation</p>	<p>The Rudder stick controls the facing direction Push the stick left and the X4 will rotate counter-clockwise Push the stick right and the X4 will rotate clockwise When the stick is in center, the X4 rotation angle is zero and doesn't rotate A harder push in either direction will cause the X4 to rotate faster in the corresponding direction.</p>
	<p>Forward</p>  <p>Backward</p>	<p>The Elevator stick moves the X4 forward and backward. Push the stick up and the X4 will fly forward Pull the stick down and the X4 will fly backward. When the stick is in center, the aircraft will hold its position. The degree of stick movement corresponds to the degree of tilt and flying speed.</p>
	 <p>Left Right</p>	<p>The Aileron stick controls left and right flight. Push the stick left and the X4 will fly left Push the stick right and the X4 will fly right The X4 should be horizontal and unmoving at center stick. The flight speed and tilt angle are linked to the distance pressed on the sticks.</p>
<div style="display: flex; justify-content: space-around; align-items: center;"> <div style="text-align: center;">  <p>position 1 (upward)</p> </div> <div style="text-align: center;">  <p>position 2 (downward)</p> </div> </div> <div style="display: flex; justify-content: space-between; margin-top: 20px;"> <div style="width: 45%;"> <p>GPS Switch</p> <p>Photo Button</p> </div> <div style="width: 45%;"> <p>Home Switch</p> <p>Video Button</p> </div> </div>  <p>Important Note: The GPS and Home functions are only for outdoor use. Please make sure the two switches keep downward when indoors.</p>	<p>The GPS Switch is a position-hold function switch. In position 1 (up), the GPS functions are active. In position 2 (down), the GPS functions are deactivated.</p> <p>The Home Switch is the Home function switch. Up (Position 1) activates the Home function. Down (Position 2) deactivates the Home function.</p> <p>For the photo and video functions, please always power off the quadcopter and the transmitter when inserting or removing the TF card.</p>	

9 ADVANCED PERFORMANCE SETUP

9.1 REVERSING CHANNEL SETUP

If you would like to reverse any of the stick functions due to personal preference then follow the instructions below. Be aware that it will change the controls back to front.

Pull the throttle stick to the lowest position and long press the Pitch stick simulatenously to enter into MAIN MENU interface. Push the Elevator stick up/down to select "Set Reverse". Select the "Exit" to exit.

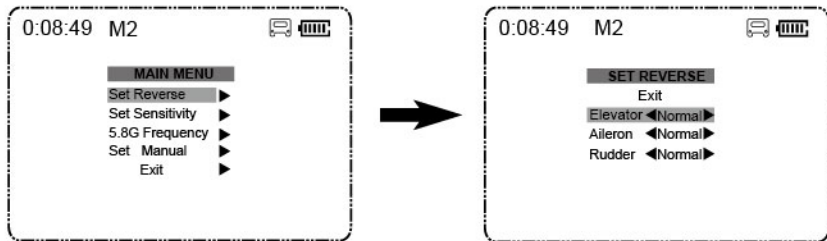

9.2 SENSITIVITY SET UP

If you would like to change the sensitivity of any of the stick functions then follow the instructions below.

Pull the throttle stick to the lowest position and long press the Elevator stick to enter into the MAIN MENU interface. Push the Elevator stick up/down to select "Set Sensitive", push the stick right to enter into the "set sensitive" interface, select "Expert mode" or "Normal mode". Select "Exit" to exit.

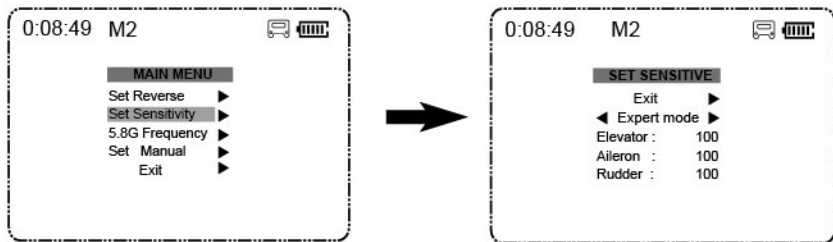

 Sensitivity default setting is in Expert Mode.

9.3 SET MANUAL SETUP

If you would like to make acrobatic flights, such as throwing, please switch off the GPS function and follow the instruction below to enter into the Manual mode

Pull the throttle stick to the lowest position and long press the Elevator stick to enter into the MAIN MENU interface. Push the Elevator stick up/down to select "Set Manual", push the stick right to enter into the "SET MANUAL" interface, select "ON" (without altitude function) or "OFF" (with altitude function). Select "Exit" to exit.

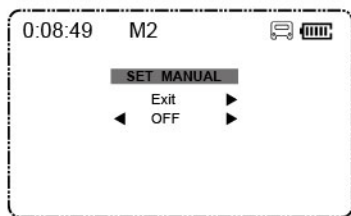
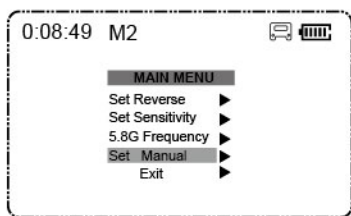

 Manual Mode default setting is OFF.

9.4 HEADLESS MODE

Headless mode means the X4 will default any direction as its head in front of the transmitter.

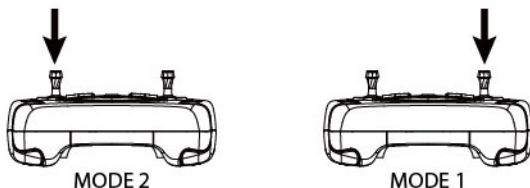

Press the Throttle stick 0.5 second to switch on/ off headless mode.

Press the stick to enter into the headless Mode, indicated by two "beeps" sounds and the "Headless On" displays on the LCD.

Press the stick again to exit headless Mode, indicated by one "beep" sound and the "Headless Off" displays on the LCD.

9.5 FOLLOW ME MODE

Follow me mode means the quad copter follows the transmitter automatically due to the built-in GPS system.

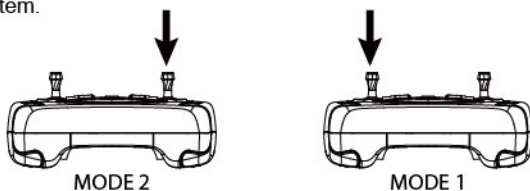

Press the Elevator stick for 0.5 second to switch on/ off follow me mode.

Press the stick to enter into the follow me Mode, indicated by two "beeps" sounds, the "Follow On" displays on the LCD and the quad copter nose will turn and face to the transmitter. The function keys are not workable except the throttle stick.

Press the stick again to exit follow me Mode, indicated by one "beep" sound and the "Follow Off" displays on the LCD.

 The follow me mode only work when the transmitter's and the quad copter's GPS both with 6 satellites or above.

9.6 RTH MODE

ENTER INTO RTH MODE

Push the GPS Switch and the Home Switch up, and the quad copter will enters into RTH Home. The flight control system will control the quad copter fly back to the takeoff point automatically.

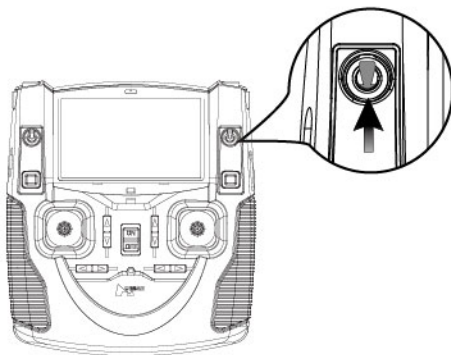

EXITING RTH MODE

Pull down the Home function switch, the X4 will exit the failsafe Mode.

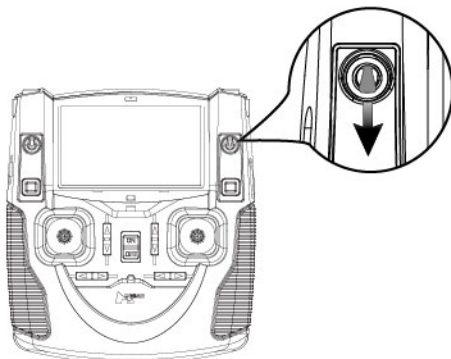

 The RTH MODE only work when the GPS with 6 satellites or above.

9.7 FAILSAFE MODE

The quad copter will enter into failsafe mode when the connection is lost from the transmitter. The flight control system will control the quad copter to return to the 'home' position and land automatically. The failsafe mode help to reduce injuries or damages.

 **DEPARTURE POINT:** When the X4 enters into the failsafe mode (no GPS) from semi-safe flight states, the X4 will record that position as the 'home' point.

CONDITIONS WHICH ACTIVATE THE FAILSAFE MODE

- (1) Transmitter is power off.
- (2) The flight distance is beyond the effective distance of the transmitter's signal transmission.
- (3) There are obstacles between the X4 and the transmitter.
- (4) The transmitter's signal was interrupted by some other strong electronic interference.

- To ensure that the X4 can return safely to its home point when signal is lost, fly the X4 in the safe flight state.
- If the quantity of GPS satellites drops below six for more than 20 seconds while the X4 is returning to home, the X4 will descend automatically.
- The X4 will not avoid obstacles automatically while in failsafe mode. You must set the height value to avoid obstacles in the X4's path.

10. OPTIONAL TRANSMITTE

Option 1. Multi-function FPV TX FPV1

5.8G real-time video transmission with 3.7 inches LCD



Option 2. Android System Transmitter H7000

1280*720P IPS LCD and dual-core 1GHz Processor



H501S TROUBLESHOOTING

1. Transmitter and X4 do not pair

- 1) Check if the transmitter and the X4 are both power on or not.
- 2) Re-pair by the following steps
 - 1 Power off the transmitter
 - 2 Press the camera function key and power on the transmitter till "Bing to plane" displays on the LCD screen
 - 3 Face the X4's bottom to the transmitter's LCD screen very closely and power on the X4, hold 5 seconds till the pair is finished.

2. Cannot Unlock the propellers

- 1) Make sure the X4 is finished the compass calibration.
- 2) Make sure the Home switch is in the downward position
- 3) Make sure the sticks are all in the center positions.

3. Cannot Search GPS Signals

Make sure not fly indoor or fly surround by buildings

Make sure fly in outdoor and in an open field and void of obstacles, tall building or steel structures.

4. No Video or Video is Under Strong Interference

1. Check if any strong interference sources around or not
2. Check if the frequencies of the X4 and the transmitter are under cross interference or not. (If so, please re-pair the X4 and the transmitter)

5. Cannot Hover

Check if the barometric parameters displayed on the transmitter are correct or not.

Check if the sticks are in the center position or not. (If not, please push the sticks to the center positions)

6. Cannot Flight In a Set-Waypoint

Make sure the GPS switch is in upper position.

Make sure the GPS satellites are up to 6 or above.

Make sure all the sticks are in the center positions, except the throttle stick.

7. Follow Me Function Not Work

Make sure the GPS switch is in upper position.

Make sure the GPS satellites are up to 6 or above.

Make sure all the sticks are in the center positions, except the throttle stick.

Make sure 5 meters at least between the X4 and the transmitter.

8. Cannot Take Picture or Record

Make sure the TF card is inserted correctly.

Make sure the TF card is compatible. (FAT32 format is recommended. Please format the TF card before using)

9. Home Mode Function Not Work

Make sure the GPS satellites are up to 6 when take off

10. GPS Satellites Dropping

Make sure no interference sources around. (Such as power lines, base stations or cell towers)

11. X4 or Video Shaking

Check if the propellers are damaged or not. Damaged propellers should be replaced in time.

Check if the screws are tightened or not.

Check if the motor shaft is damaged or not. Damaged motors should be replaced in time.

SCHEMATIC DIAGRAM

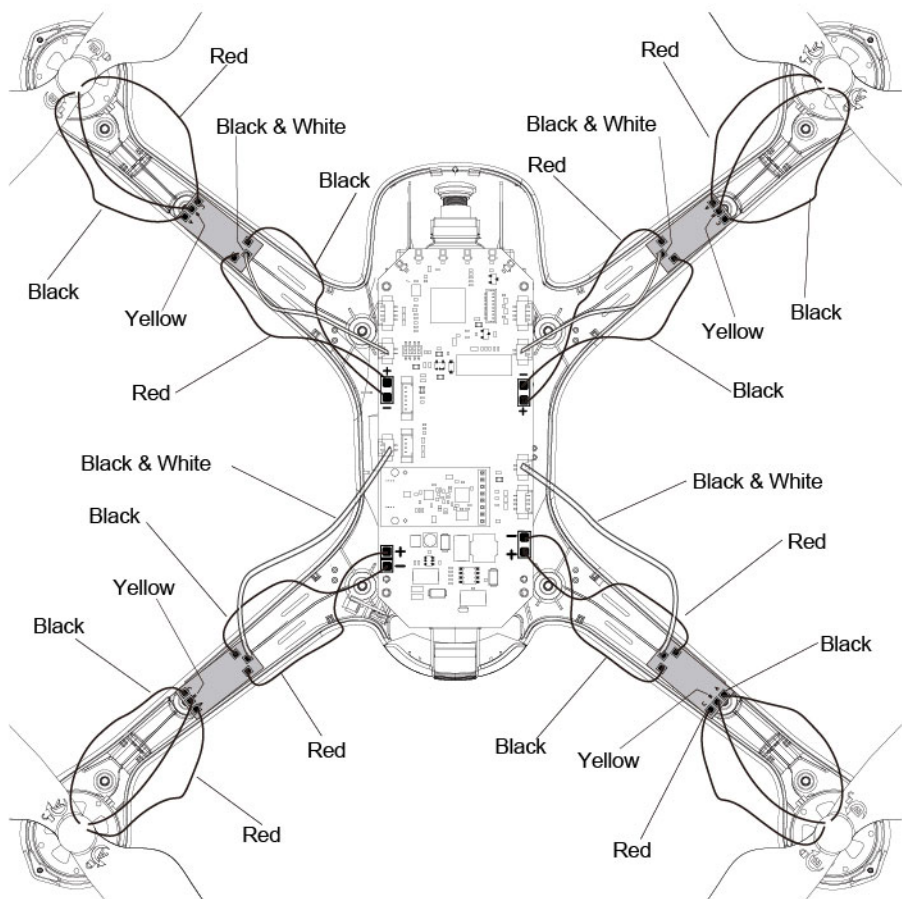

FCC INFORMATION

This equipment has been tested and found to comply with the limits for a Class B digital device, pursuant to Part 15 of the FCC Rules. These limits are designed to provide reasonable protection against harmful interference in a residential installation. This equipment generates, uses, and can radiate radio frequency energy and, if not installed and used in accordance with the instructions, may cause harmful interference to radio communications. However, there is no guarantee that interference will not occur in a particular installation. If this equipment does cause harmful interference to radio or television reception, which can be determined by turning the equipment off and on, the user is encouraged to try to correct the interference by one or more of the following measures:

- Reorient or relocate the receiving antenna.
- Increase the separation between the equipment and receiver.
- Connect the equipment into an outlet on a circuit different from that to which the receiver is connected.
- Consult the local dealer or an experienced radio/TV technician for help.

Changes or modifications not expressly approved by the party responsible for compliance could void the user's authority to operate the equipment.

This device complies with Part 15 of the FCC Rules. Operation is subject to the following two conditions: (1) this device may not cause harmful interference, and (2) this device must accept any interference received, including interference that may cause undesired operation.

Electrical and electronic equipment that are supplied with batteries (including internal batteries)

WEEE Directive & Product Disposal

At the end of its serviceable life, this product should not be treated as household or general waste. It should be handed over to the applicable collection point for the recycling of electrical and electronic equipment, or returned to the supplier for disposal.

Internal / Supplied Batteries.

This symbol on the battery indicates that the battery is to be collected separately.

This battery is designed for separate collection at an appropriate collection point.



User manual is subject to change without prior notice due to unforeseen product upgrades.

Download the latest user manual from

WWW.HUBSAN.COM

VERSION 1.2 EN

