



Made for ideas.

LACIE 2BIG THUNDERBOLT 2 USER MANUAL



CLICK [HERE](#) TO ACCESS AN **UP-TO-DATE ONLINE VERSION**

of this document. You will find the most recent content as well as expandable illustrations, easier navigation, and search capability.



INTRODUCTION



Welcome to the User Manual for the LaCie 2big Thunderbolt™ 2. LaCie's Thunderbolt 2 storage enclosures feature transfer rates with the potential to reach up to 20Gb/s bi-directional. Connect the LaCie 2big to a computer that supports Thunderbolt 2 technology for the ultimate in performance with 4k video and graphics. The LaCie 2big is ideal for professional editors, photographers, and graphic artists that demand extraordinary performance both in the office and the field.

The LaCie 2big also features a USB 3.0 port. Transfer rates can reach up to 5Gb/s when connected to a computer with a USB 3.0 port. Since it is backwards compatible, USB 3.0 gives you universal connectivity to any computer with a USB 2.0 port.

This manual will guide you through the process of connecting your LaCie 2big enclosure and explain its features. For questions on installation or use, consult the [Getting Help](#) page.

BOX CONTENT

- LaCie 2big Thunderbolt 2
- External power supply
- USB 3.0 cable (USB 2.0 compatible)
- Thunderbolt cable
- Removable access panel
- RAID selection tool
- Quick Install Guide

Important info: Save your packaging. In the event that the hard drive should need to be repaired or serviced, it must be returned in its original packaging.

Software suite

Visit [LaCie 2big Thunderbolt 2 software](#) to download your free suite of utilities including:

- Intego® Backup Manager Pro (Mac®)
- Genie® Backup Manager Pro™ (Windows®)
- LaCie Desktop Manager (monitor hard drive health and configure email alerts)
- LaCie Private-Public (protect data with AES 256-bit encryption)

MINIMUM SYSTEM REQUIREMENTS

Your system must meet certain requirements in order for your LaCie product to function properly. For a list of these requirements, please refer to the product packaging or consult the product support web page at www.lacie.com/support/.

VIEWS OF THE ENCLOSURE

Front view

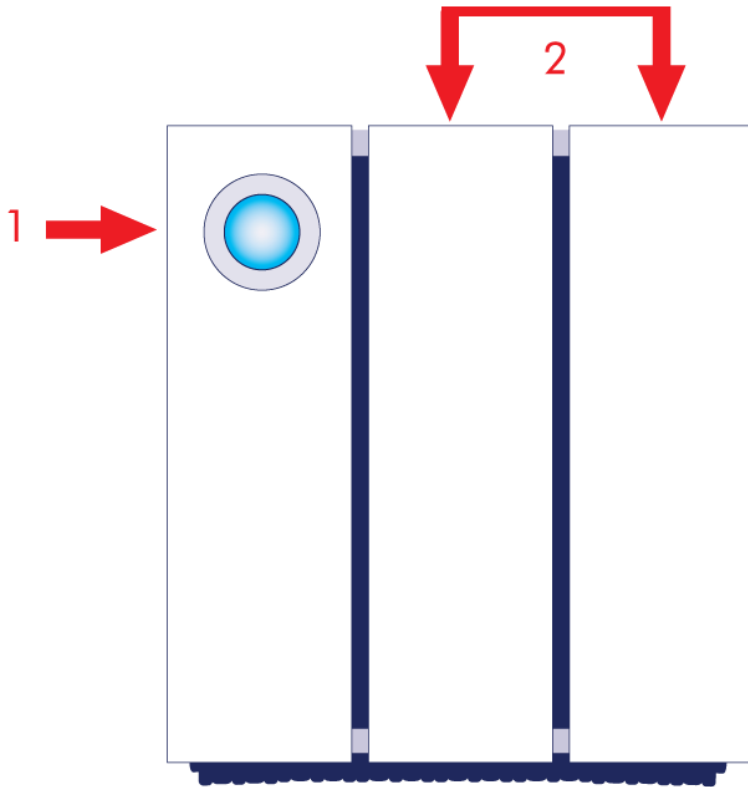

1. LED and power button
2. Hard drive trays

Top view

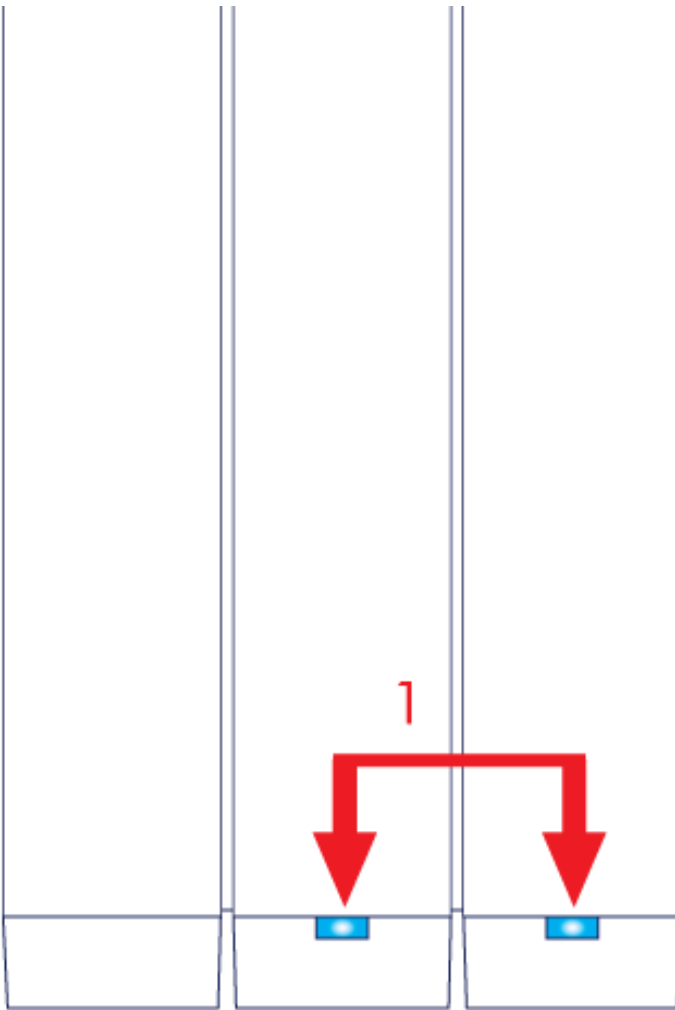

1. Hard drive LEDs

Side view

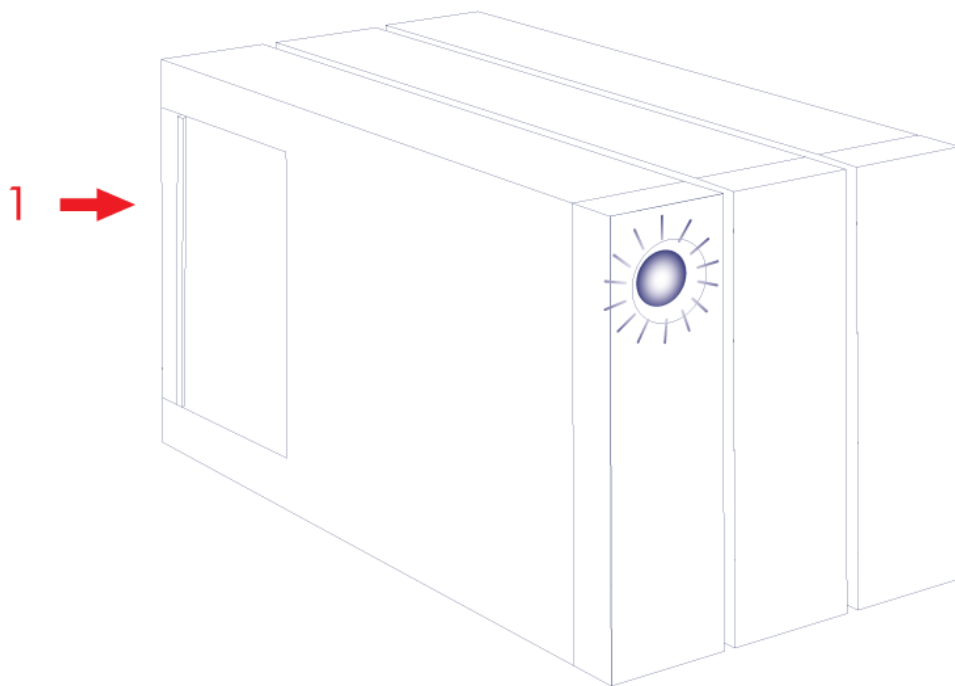

1. Removable access panel

Side view - open panel

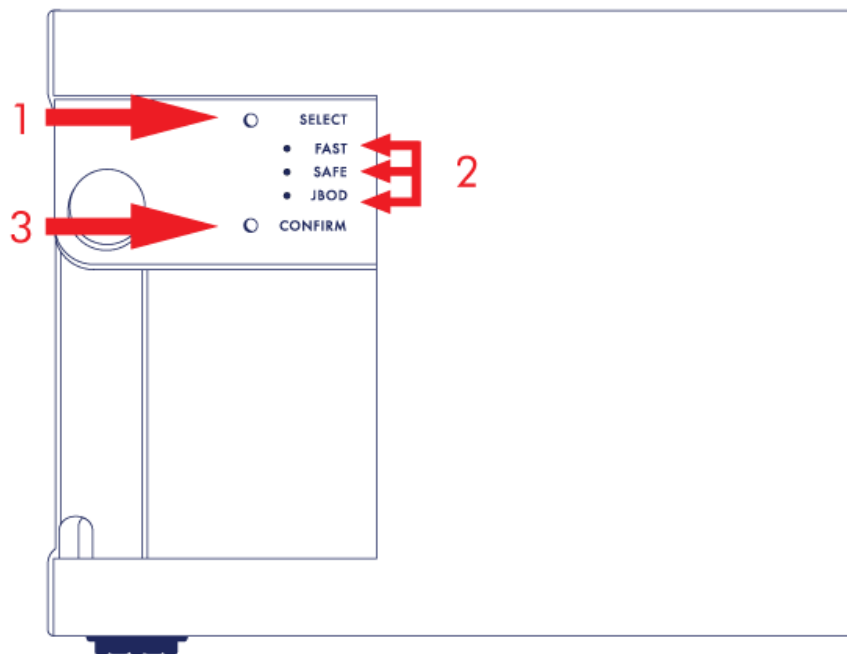

1. **SELECT**: RAID selection button
2. **FAST**, **SAFE**, **JBOD**: LEDs for RAID modes
3. **CONFIRM**: RAID confirmation button

Rear view - open panel

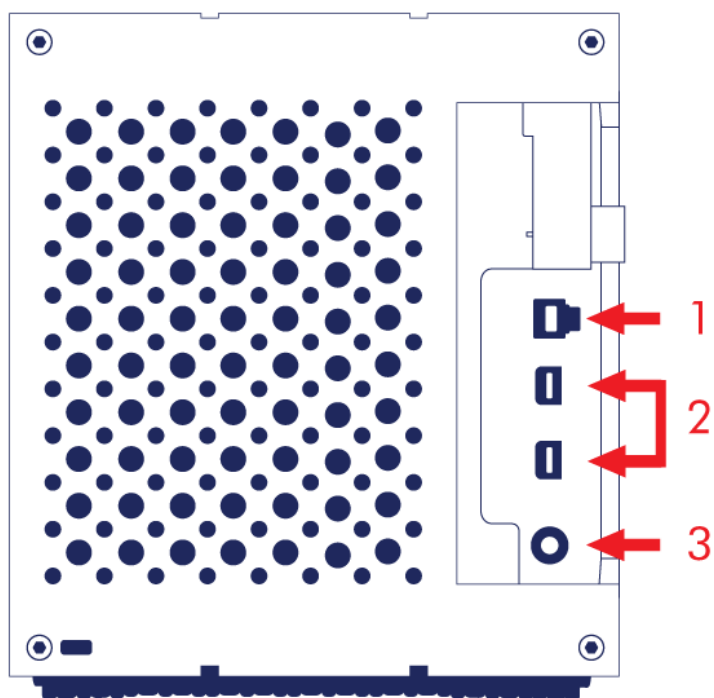

1. USB 3.0 port
2. Thunderbolt 2 ports
3. Power supply connection (12V 5A)

QUIET OPERATION AND HEAT MANAGEMENT

To reduce noise during operation, the LaCie 2big's fan is located at the back of the device. The advanced thermo-regulated fan guarantees optimal heat management by adjusting its rotational speed for the environment and a wide exhaust chamber allows for enhanced airflow. Additionally, the LaCie 2big's metal casing dissipates heat from the hard drives, keeping them safe and prolonging their life. Since LaCie's unique design draws heat away from the internal hard drives, the external casing will be warm to the touch after extended use.

Important info: Make sure that the exhaust vent on the back bezel is not obstructed and that there is a natural airflow across the casing.

POSITION AND STACKING

Always make certain to place the LaCie 2big on a flat, even surface designed to support the heat output and airflow of a professional hard drive enclosure. For proper heat dissipation, the LaCie 2big is designed to stand on its rubber feet, situated on the bottom of the enclosure. DO NOT place the enclosure on its side when it is powered on.

When using multiple enclosures, you can stack one LaCie 2big Thunderbolt 2 enclosure on top of another LaCie 2big Thunderbolt 2 enclosure. However, due to the weight and balance of the LaCie 2big, stacking more than two enclosures poses a severe risk that the devices will fall. DO NOT stack other hard drives, enclosures, or equipment on top of the LaCie 2big.

The warranty for your LaCie 2big Thunderbolt 2 will be voided if you:

- Stack more than two LaCie 2big Thunderbolt 2 enclosures.
- Stack other hard drives, enclosures, or equipment on top of the LaCie 2big Thunderbolt 2.

LACIE 2BIG THUNDERBOLT 2: ADVANCED STORAGE TECHNOLOGY

THUNDERBOLT 2 TECHNOLOGY

The LaCie 2big Thunderbolt 2 uses Thunderbolt 2 technology, the fastest, most versatile connection for your computer. While first generation Thunderbolt technology transfer rates are 10Gb/s bi-directional, Thunderbolt 2 technology provides 20Gb/s bi-directional. Additionally, Thunderbolt 2 technology gives priority to the video stream, apportioning the required bandwidth for playback. This is a critical advantage when working with high-end video and 3D graphics.

For example, an editor is working with two streams, 4K video at 12Gb/s and data at 4Gb/s. Whereas first generation Thunderbolt technology may experience difficulty with the video signal, Thunderbolt 2 technology allows it to pass without a problem, dividing the bandwidth as needed for playback.

Important cable info: When connecting your Thunderbolt enclosure to a computer or compatible devices, use cables specifically constructed to support Thunderbolt technology.

Important info: A Thunderbolt enclosure must be connected to a computer that supports Thunderbolt technology. While the ports on the back of the device can easily seat Mini DisplayPort cable ends for daisy chaining displays, the Thunderbolt storage will only work when connected to a computer that supports Thunderbolt technology.

LaCie 2big Thunderbolt 2 technology: hardware RAID for protection and performance

Featuring hardware RAID, the LaCie 2big is a rarity in the world of high-end direct-attached storage (DAS). While most DAS must choose between high transfer rates or data protection, the LaCie 2big offers both extraordinary performance and built-in protection. Its RAID saves your computer from expending critical processing resources on storage management, which is crucial for video and graphics applications that place heavy demands on computer CPUs. Further, hardware RAID gives you options to configure the hard drives to suit the needs of your working environment (see [Manage RAID](#)).

The LaCie 2big features:

- Desktop convenience
- Aluminum front and all-metal enclosure
- Hardware RAID
- RAIDs FAST (RAID 0), SAFE (RAID 1), and JBOD
- Two Thunderbolt 2 technology ports, up to 20Gb/s bi-directional per port
- One USB 3.0 port, up to 5Gb/s and universal connectivity
- Daisy chain Thunderbolt 2 and first generation Thunderbolt devices (up to seven, including the computer)
- Hot-swappable hard drives to reduce downtime

LEDS AND LED POWER BUTTON

LED STATES

The LED on the front of the LaCie 2big provides indications on the state of its health:

LED	State
Solid blue	The product is in active mode.
Blinking blue	The product is starting up or shutting down. The LED will become solid blue once it has initialized.
Blinking blue and red	The product is synchronizing the RAID SAFE.
Solid red	RAID SAFE is broken; the device's temperature is too high; or, the product is experiencing a severe error. Contact LaCie technical support
Blinking red	RAID SAFE is degraded.
Off	The product is: turned off; not receiving power; in idle mode; experiencing system failure; or, experiencing electronic board failure. See below for information on powering down the hard drives within the enclosure. If the device is connected to a power supply and turned on but the LED remains off, contact LaCie technical support .

Hard drive LEDs

The hard drive LEDs are located on top of the hard drive drawers.

LED Behavior	State
Solid blue	The product is in active mode.
Blinking blue	The product is starting up; data is being copied to or from the product; data is being accessed.
Solid red	Failed hard drive. Contact LaCie technical support
Off	The product is: turned off; not receiving power; in idle mode; experiencing system failure; or, experiencing electronic board failure. See below for information on powering down the hard drives within the enclosure. If the device is connected to a power supply and turned on but the LED remains off, contact LaCie technical support .

Receiving power

The LaCie 2big powers on automatically when it meets the following two conditions:

- Connected directly to a computer via the USB port. The computer must be powered on.
- Connected to a live power source via the included power supply.

Note on the USB 3.0 connection: The LaCie 2big can be connected to a USB 2.0 port on your computer. To take advantage of SuperSpeed USB 3.0 transfer rates, you must connect the enclosure to a computer with a USB 3.0 port.

LED BUTTON

The LED is also a button to turn the LaCie 2big on or off. Always eject the LaCie 2big's volumes before turning it off or placing it in idle and power-saving modes.

- **Long press.** Push the LED for two seconds to power off the enclosure.
- **Short press.** Push the LED for one second to: power on the device; place the device into idle mode (Thunderbolt 2 only, see below); wake the device from idle mode (Thunderbolt 2 only, see below); or, place the device into power-saving mode (USB 3.0, see below).

The LaCie 2big powers on automatically when it is connected to a computer that is also powered on. However, if you turn the LaCie 2big off using a long press, you must turn the device on manually.

Idle mode (Thunderbolt 2 only)

You can use the LED button to enter idle mode:

1. Unmount the volumes (see [Unmounting Your Drive](#)).
2. Apply a short press to the LED button.

The enclosure will stop sending power to the hard drives. Idle mode allows you to daisy chain Thunderbolt 2 devices and first generation Thunderbolt devices even when the hard drives are not active.

To exit idle mode, apply a short press to the LED button. The hard drives spin up and the volumes should appear on the desktop.

Technical note: The LaCie 2big must receive power via its power cable to allow for a daisy chain in idle mode.

Power-saving mode (USB 3.0)

The LaCie 2big will stop sending power to the hard drives when it enters power-saving mode. To spin down the hard drives, apply a short press to the LED button. Perform the same action to exit power-saving mode.

CABLES AND CONNECTORS





MAC

THUNDERBOLT

Your LaCie product features Thunderbolt 2 technology, the most flexible interface ever created. When connected to a computer that supports Thunderbolt 2 technology, your LaCie device can reach up to 20Gb/s, bi-directional, on a single port, the fastest data connection available on a personal computer.

You can also use Thunderbolt 2 technology storage devices with computers that support first generation Thunderbolt. However, you will be limited to first generation technology transfer rates, up to 10Gb/s, bi-directional.

Thanks to support for both data streams and mini DisplayPort video, you can connect either a storage peripheral or a display to a Thunderbolt port. However, it's not possible to use a mini DisplayPort cable to connect a storage peripheral to a Thunderbolt port. You must use a Thunderbolt cable.

Connector Face (to computer)	Cable End (to computer)	Cable End (to product)	Connector Face (to product)
			





PC/MAC

USB 3.0

USB is a serial input/output technology for connecting peripheral devices to a computer. SuperSpeed USB 3.0 is the latest implementation of this standard, and it provides higher bandwidth and new power management features.

Transfer rates can attain up to 5 Gbits/s as opposed to USB 2.0's 480 Mbits/s. This means USB 3.0 is theoretically up to ten times faster than its predecessor.

Your LaCie drive is shipped with a SuperSpeed USB 3.0 cable to ensure maximum data transfer performance when connected to a compatible USB 3.0 port. The cable will also work when connected to a USB 2.0 or 1.1 port, but drive performance will be limited to their respective transfer rates.

Connector Face (to Computer)	Cable End (to Computer)	Cable End (to Hard Drive)	Connector Face (to Hard Drive)
			

GETTING CONNECTED

Follow the steps in the order they are given to ensure that the LaCie 2big Thunderbolt 2 volume mounts correctly on your computer. By default, the drives are configured in FAST mode (see [Manage RAID](#)) and formatted for Mac (HFS+ journaled).

WINDOWS AND THE LACIE 2BIG

Since the LaCie 2big is preconfigured for Mac, Windows users must clean the hard drives when first connecting the device to the computer. Directions to clean the hard drives can be found below ([Windows only - clean the hard drives](#)).

CONNECT THE INTERFACE AND POWER CABLES

1. Remove the side panel to access the interface and power connections. Place one hand on the front of the device for balance and use the other hand to push on the rear of the panel and slide the panel away from the enclosure. **Important:** The side panel may require added pressure to remove it from the slot.

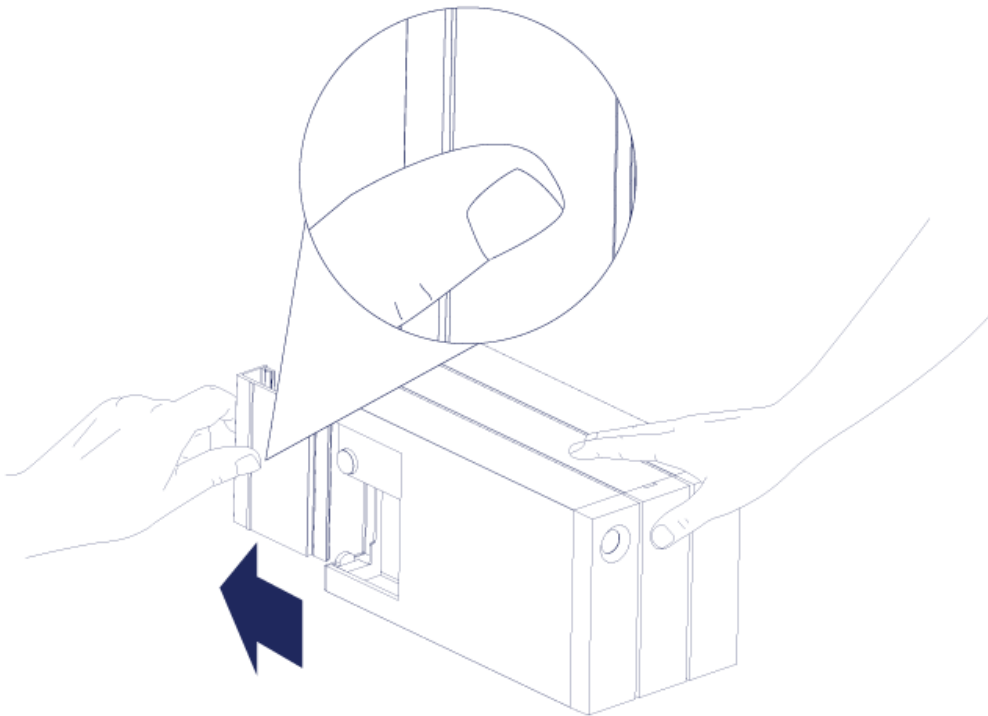

2. Connect the included power supply in the following order:
 1. The LaCie 2big's power port.
 2. An active power outlet.

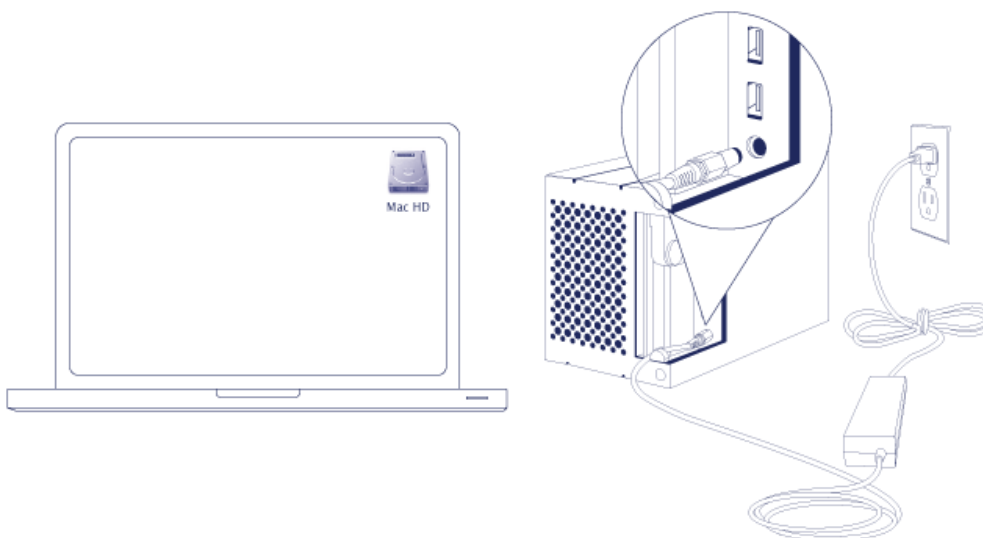

3. Connect the LaCie 2big to your computer. Plug one end of the cable to the LaCie 2big and the other end to a compatible port on your computer.



- Thunderbolt 2 (Mac): Use the included Thunderbolt technology cable. The second Thunderbolt 2 port on the enclosure can be used to daisy chain compatible devices and displays (see [Daisy Chain \(Thunderbolt 2 only\)](#)).
 - USB 3.0 (PC/Mac): Use the included USB 3.0 cable. USB 3.0 transfer rates are only available when connecting the LaCie 2big to a computer with a USB 3.0 port.
4. The LaCie 2big will turn on automatically if your computer is powered on.
- **Mac users:** The volume will mount on the desktop.
 - **Windows users:** Clean the hard drives before formatting them for Windows. See the note below.
5. Replace the side panel to protect the cable connections. **Important:** The side panel may require added pressure to reinsert it into the slot.

Windows only - clean the hard drives

Since the hard drives are formatted for Mac (HFS+), all partitions must be erased, including the EFI partition. Windows Disk Management cannot erase the EFI partition so you must run **Diskpart**, a separate Windows utility. For additional information on Diskpart, click [here](#).

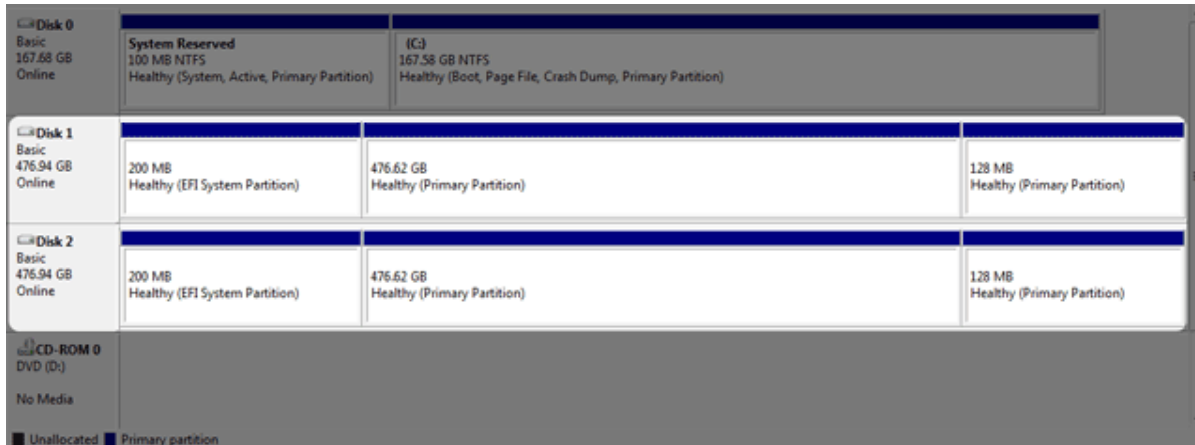

Important info: Cleaning hard drives is data destructive. If you have data on the LaCie 2big, LaCie recommends that you back up all files before following the steps below.

The steps below are illustrated using a standard hard drive enclosure with two hard drives. The images may not represent your product.

1. Diskpart will delete and format any hard drive that you select. Therefore, to avoid deleting data on other devices, disconnect all external hard drives from your PC except the LaCie 2big. **LaCie is not responsible for lost data.** Diskpart cannot delete the System disk.
2. Connect the LaCie product to your Windows computer via the included USB 3.0 cable (see [Getting Connected](#)). If necessary, turn the device on (see [LEDs and LED Power Button](#)).
3. Search for and launch **Diskpart**.

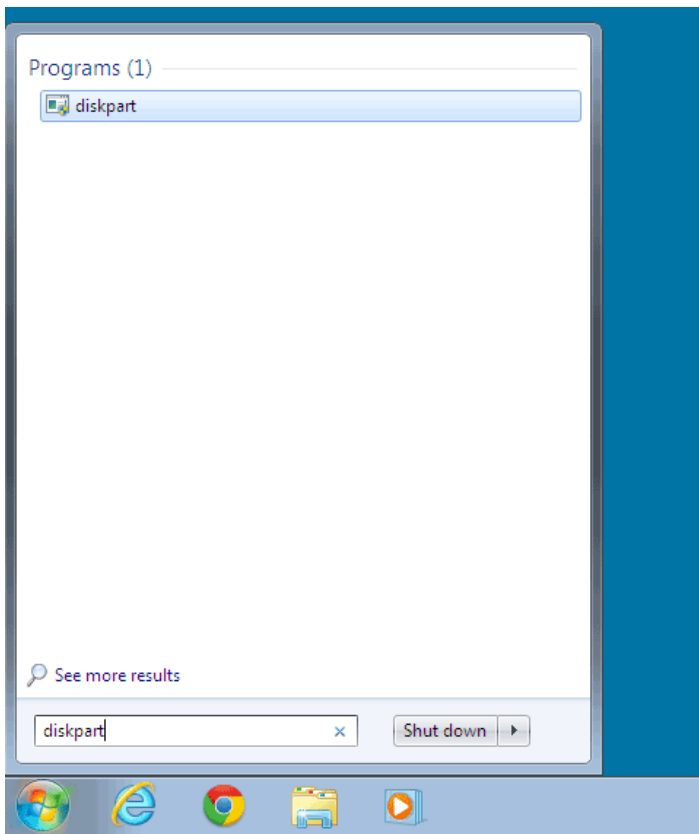

4. In the Diskpart prompt, type **list disk**.

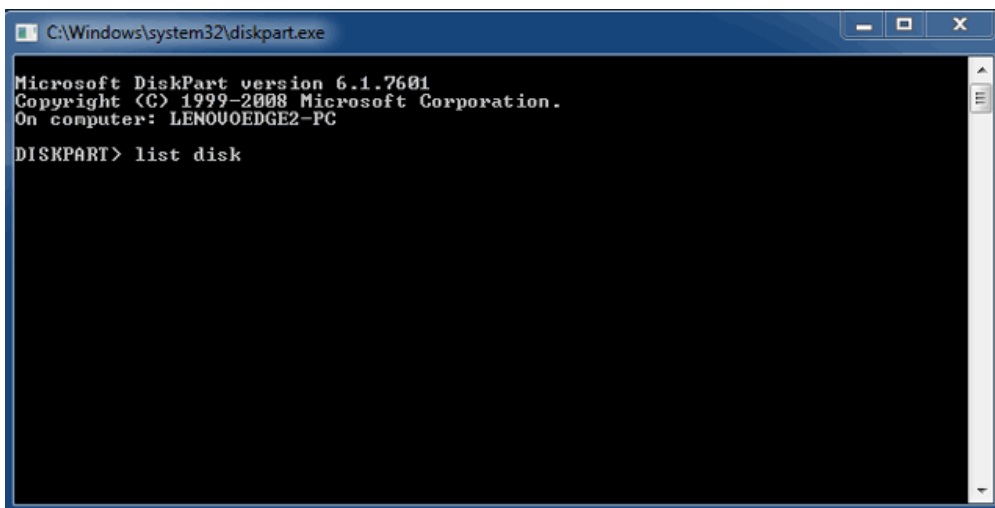

5. Make certain to locate the disk number(s) for your LaCie device then type **select disk *n***. *n* is the number for the first LaCie hard drive (1 in the screenshot below). If you are uncertain of the disk number for the LaCie product, launch **Disk Management**. You should see the number assigned to the LaCie product.

```
C:\Windows\system32\diskpart.exe
Microsoft DiskPart version 6.1.7601
Copyright (C) 1999-2008 Microsoft Corporation.
On computer: LENOVOEDGE2-PC

DISKPART> list disk

   Disk ###  Status              Size               Free                Dyn  Gpt
   -----  -
   Disk 0    Online              167 GB             0 B
   Disk 1    Foreign             476 GB             0 B                *
   Disk 2    Foreign             476 GB             0 B                *
```

6. Diskpart will confirm that your hard disk has been selected.

```
C:\Windows\system32\diskpart.exe
Microsoft DiskPart version 6.1.7601
Copyright (C) 1999-2008 Microsoft Corporation.
On computer: LENOVOEDGE2-PC

DISKPART> list disk

   Disk ###  Status              Size               Free                Dyn  Gpt
   -----  -
   Disk 0    Online              167 GB             0 B
   Disk 1    Foreign             476 GB             0 B                *
   Disk 2    Foreign             476 GB             0 B                *
```

```
DISKPART> select disk 1

Disk 1 is now the selected disk.

DISKPART>
```

7. To delete all partitions on the hard disk, type **clean**.

```
C:\Windows\system32\diskpart.exe
Microsoft DiskPart version 6.1.7601
Copyright (C) 1999-2008 Microsoft Corporation.
On computer: LENOVOEDGE2-PC

DISKPART> list disk

   Disk ###  Status              Size               Free                Dyn  Gpt
   -----  -
   Disk 0    Online              167 GB             0 B
   Disk 1    Foreign             476 GB             0 B                *
   Disk 2    Foreign             476 GB             0 B                *
```

```
DISKPART> select disk 1

Disk 1 is now the selected disk.

DISKPART> clean
```

8. Diskpart will confirm that your hard disk is clean, meaning that the partitions have been deleted.

```
C:\Windows\system32\diskpart.exe
Microsoft DiskPart version 6.1.7601
Copyright (C) 1999-2008 Microsoft Corporation.
On computer: LENOVOEDGE2-PC

DISKPART> list disk

  Disk ###  Status         Size           Free           Dyn  Gpt
  -----  -
  Disk 0    Online         167 GB         0 B
  Disk 1    Foreign        476 GB         0 B          *
  Disk 2    Foreign        476 GB         0 B          *

DISKPART> select disk 1
Disk 1 is now the selected disk.

DISKPART> clean
DiskPart succeeded in cleaning the disk.

DISKPART>
```

9. The LaCie product is ready to be formatted for your operating system. See [Formatting](#) for instructions.

UNMOUNTING THE VOLUME

In order to avoid file system corruption, it is important to unmount the volumes before turning off the enclosure or disconnecting the interface cable. See [Unmounting Your Drive](#) for details.

DAISY CHAIN (THUNDERBOLT 2 ONLY)

Use the enclosure's two Thunderbolt 2 technology ports for:

- Direct connection to a computer that is compatible with Thunderbolt 2 technology or first generation Thunderbolt technology
- Daisy chaining with devices and displays that are compatible with Thunderbolt 2 technology and first generation Thunderbolt technology

DAISY CHAIN: THUNDERBOLT 2 TECHNOLOGY AND FIRST GENERATION THUNDERBOLT TECHNOLOGY

Thunderbolt 2 technology is an update of first generation Thunderbolt technology. While Thunderbolt technology continues to provide impressive transfer rates of up to 10Gb/s bi-directional, Thunderbolt 2 technology offers improved performance with a potential of up to 20Gb/s bi-directional. Thunderbolt 2 technology also gives you greater flexibility when using video and data, assigning greater throughput to the stream that carries the heavier load. You must have a computer that supports Thunderbolt 2 technology in order to take advantage of the updates in performance and the intelligent sharing of bandwidth.

Similar to first generation Thunderbolt technology, a single Thunderbolt 2 technology daisy chain can have up to seven devices, including the computer. For example, you can daisy chain five LaCie 2big Thunderbolt 2 enclosures on the same line with a display. Provided that your computer supports Thunderbolt 2 technology, transfer rates have the potential to reach up to 20Gb/s bi-directional for all devices.

You can also add the LaCie 2big to a daisy chain that includes first generation Thunderbolt technology devices. For example, your computer supports Thunderbolt 2 technology and you add the LaCie 2big to a daisy chain that includes three first generation Thunderbolt technology storage devices and a display with a MiniDisplay port. In such a case, make certain that the LaCie 2big is the first enclosure connected to the computer. You can lose the higher performance offered by Thunderbolt 2 technology if a Thunderbolt 2 device is daisy-chained behind first generation Thunderbolt devices and/or displays.

How to daisy chain

Connect the Thunderbolt cable to one of the Thunderbolt 2 ports on the back of the LaCie 2big and to your computer. The additional port may be used to daisy chain compatible first generation Thunderbolt and Thunderbolt 2 peripherals, such as hard drives and monitors. If you have another Thunderbolt 2 storage device, make certain to connect it to the LaCie 2big before adding first generation Thunderbolt technology devices and/or displays.

Important cable info: When connecting your enclosure to a computer or compatible devices, use cables specifically constructed to support Thunderbolt technology. Thunderbolt technology cables are compatible with Thunderbolt 2 technology devices and first generation Thunderbolt technology devices.

Important info: To reach Thunderbolt 2 technology transfer rates of up to 20Gb/s bi-directional, the LaCie 2big must be connected to a computer that supports Thunderbolt 2 technology. Connecting the LaCie 2big to a computer that supports first generation Thunderbolt technology allows for transfer rates up to 10Gb/s bi-directional.

Daisy chain: idle mode

You can daisy chain Thunderbolt 2 technology and first generation Thunderbolt technology devices even when the disks are spun down. To enter idle mode, apply a short push to the LED power button (see [LEDs and LED Power Button](#)). The status LED will blink slowly, indicating that the LaCie 2big is in idle mode. Thunderbolt devices daisy-chained to the LaCie 2big will continue to receive power.

LACIE DESKTOP MANAGER

LaCie Desktop Manager is a software utility that provides important information regarding the status and health of your device.

INSTALLING LACIE DESKTOP MANAGER

Follow the directions below:

1. Click the link to download the installer for LaCie Desktop Manager: [LaCie 2big Thunderbolt 2 software](#)
2. Once the download is complete, locate the installer on your computer. Generally, downloads can be found in the Downloads folder.
3. Launch the installer for your operating system and follow the setup wizard to completion.

When setup is complete, launch LaCie Desktop Manager from the System tray (Windows) or the Menu bar (Mac).

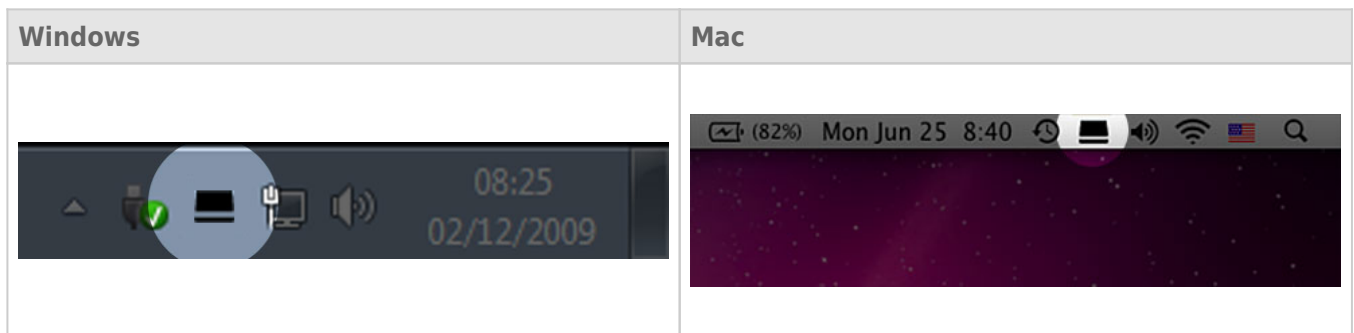

LaCie Desktop Manager provides a list of all compatible LaCie devices in the left-hand column. If you have more than one compatible LaCie device, choose a product and use the tabs to navigate to the page you want. Options can vary based upon the product.

INFO TAB

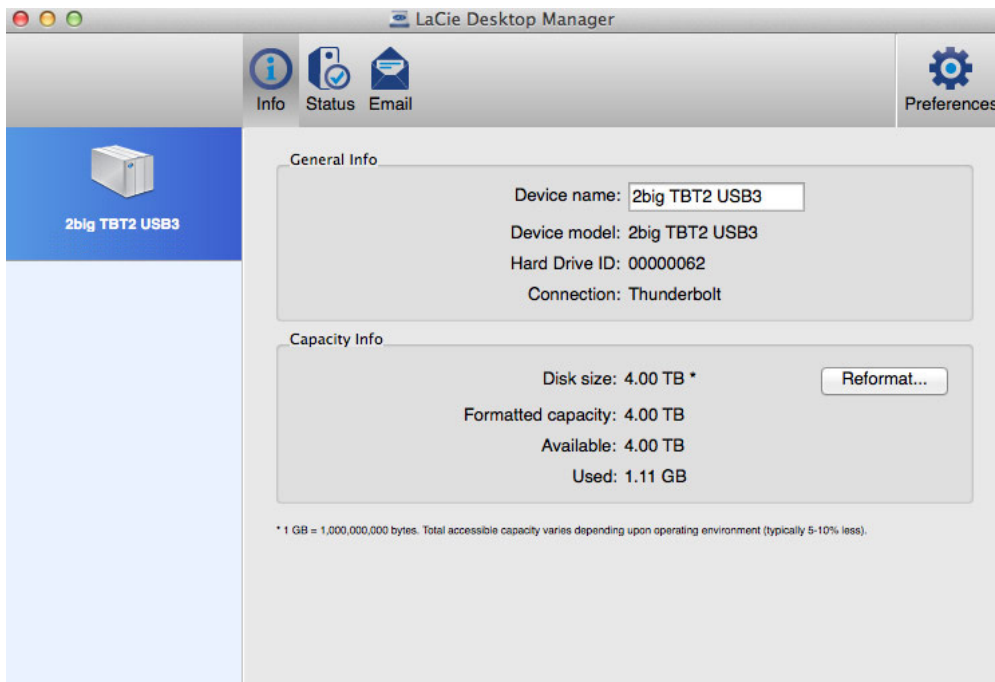

Review the details of your device:

- Name
- Model
- Hard drive ID
- Connection type
- Total capacity
- Available capacity

REFORMAT

From the **Info** tab, you can reformat the hard drives.

Caution: Choosing **Reformat** launches your operating system's disk utility (see [Formatting](#) for details). Formatting erases all data stored on your hard drives. To protect files, back up your hard drives before selecting **Reformat**.

STATUS TAB



Review the health of the:

- Hardware
- RAID configuration

You can also enable alerts to receive status updates.

Important info: Activating alerts may affect the transfer rates of your device. For optimal transfer rates, disable alerts.

EMAIL TAB

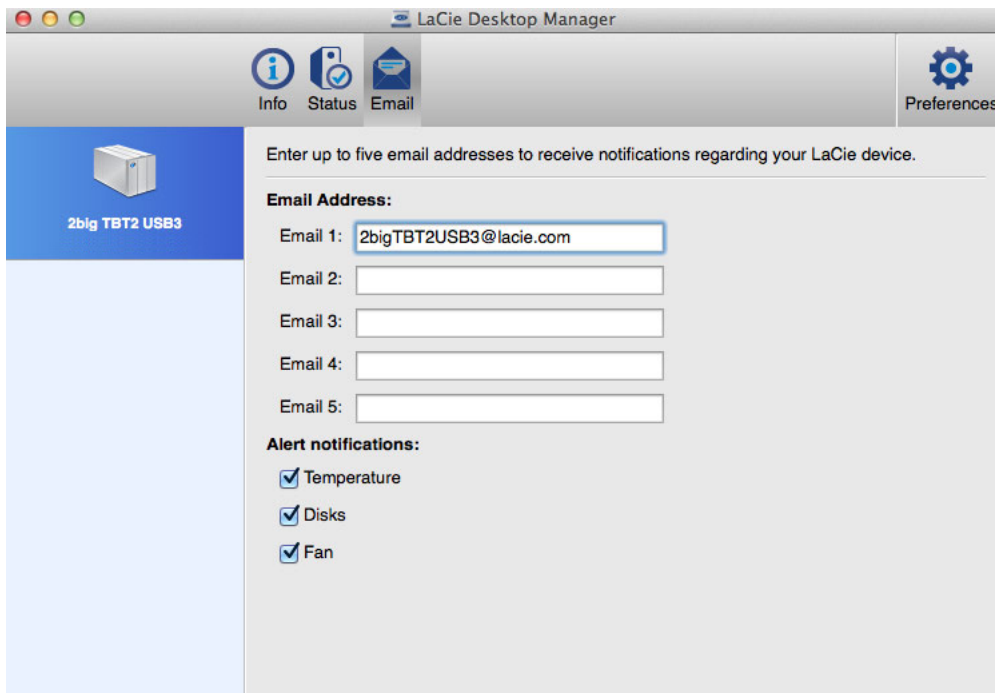

You can enter up to five email addresses to receive messages regarding changes to the status of your LaCie device. You can also enter an email subject line.

Check the boxes to select the events that trigger email alerts.

MANAGE RAID

ABOUT RAID MODES

Review the table below for an overview of the different RAID modes:

RAID mode	Capacity	Protection	Speed	Factory default
FAST (RAID 0)	100%	None	Excellent	Yes
SAFE (RAID 1)	50%	Excellent	Good	No
JBOD	100%	None	Good	No

FAST (RAID 0): RAID 0 is the fastest RAID mode. In a RAID 0 array, the available capacities of each hard drive are added together so that one logical volume mounts on the computer. It offers the best performance but no data protection should a hard drive fail.

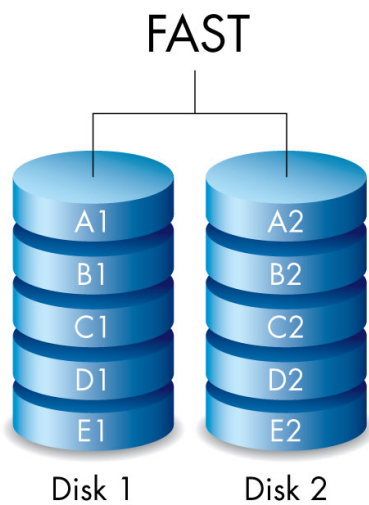

SAFE (RAID 1): RAID 1 provides data protection since all data is written to each hard drive at the same time. In the event of a single hard drive failure, data remains available on the other hard drive. Due to the time it takes to write the data twice, performance is reduced when compared to RAID 0. RAID 1 is a good choice when safety is more important than speed. However, RAID 1 also reduces the available drive space by 50% due to the need to write every bit of data to each hard drive.

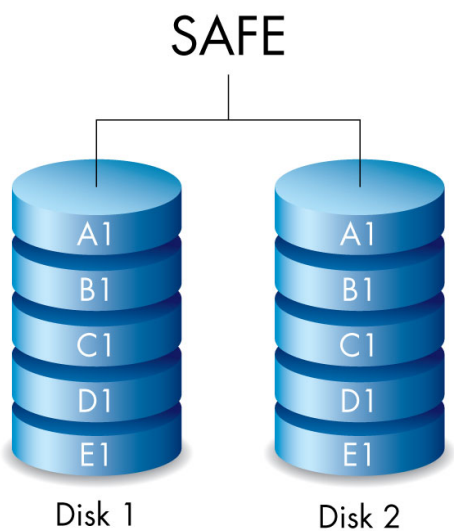

JBOD: Hard drives in a JBOD configuration are treated as individual volumes and data is stored sequentially. For example, data is written to Disk 1 first. Once Disk 1 is full, data will be written to Disk 2. An advantage to this level of RAID is the availability of 100% of the hard drives' total storage capacity. However, it does not offer protection and all data will be lost if a single hard drive fails.

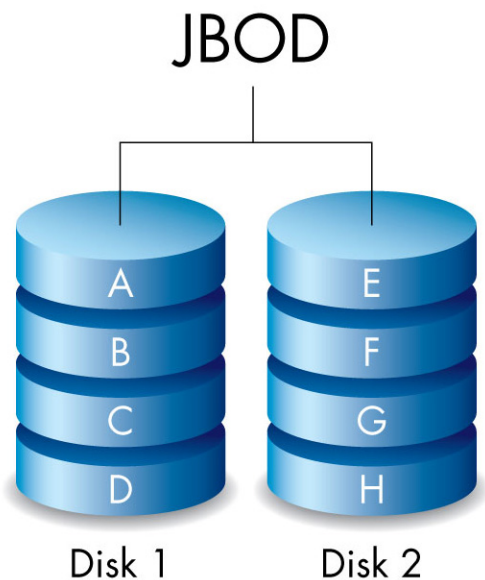

MODIFY THE RAID MODE

Important info: Changing the RAID mode destroys data stored on the LaCie 2big. Back up all your data before adjusting the RAID.

Before starting the steps below, locate the RAID selection tool included with the enclosure and know the RAID mode you want to use.

1. Unmount the LaCie 2big's volumes from your computer (see [Unmounting Your Drive](#)).
2. Power off the device using the LED button (see [LEDs and LED Power Button](#)).
3. Remove the side panel for access to the RAID selection and confirmation buttons (see [Getting Connected](#)).
The power supply must remain connected to the device.
4. Use the sharp end of the RAID selection tool to press and hold down the SELECT button.

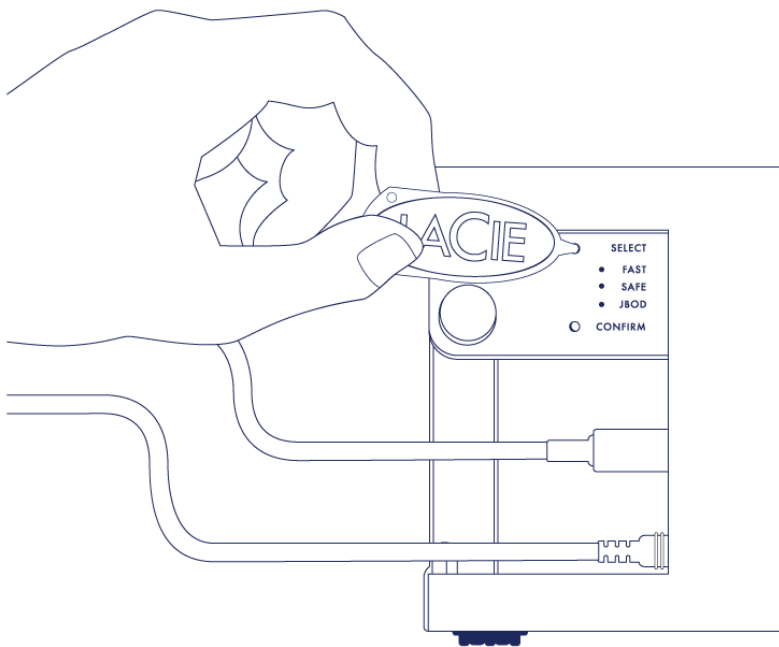

5. Without releasing the SELECT button, turn on the product by pressing the front LED button.
6. All the RAID mode LEDs flash momentarily before the LED for the current RAID mode blinks on its own. Using the RAID selection tool, press the SELECT button to toggle between the modes.

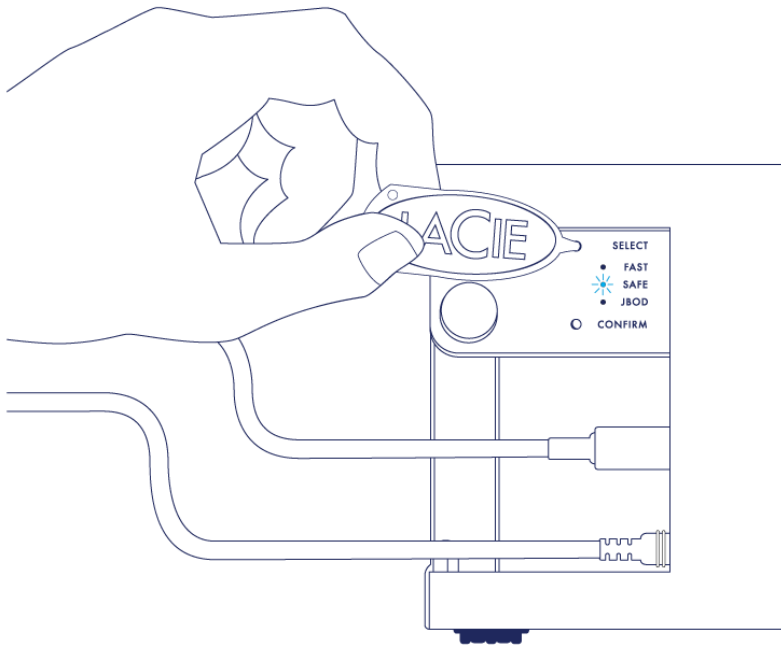

- When the LED for your preferred RAID mode is lit, use the RAID selection tool to press the CONFIRM button. **IMPORTANT:** Press CONFIRM within five seconds or the selection mode turns off and the configuration reverts to the current RAID.

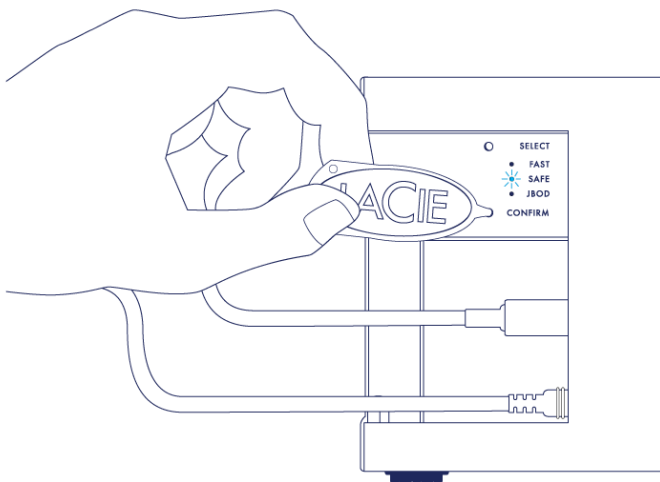

- Your computer prompts you to initialize the new RAID volume. You must initialize and format the hard drives for use with your computer (see [Formatting](#)).
- Replace the side panel to protect the cable connections.

Technical note: Behavior will differ slightly if the interface cable is not connected to its port during the RAID modification. The device will power off once the RAID has been changed.

Important info: If the RAID mode has not been changed, you can try the steps again. When following the steps, make certain to choose CONFIRM as soon as the LED toggles to your preferred RAID mode.

RAID configuration times

The table below provides estimated times to configure the RAID.

RAID	Time to complete
FAST	Less than a minute
SAFE	Several hours to one or more days (see note below)
JBOD	Less than a minute

The time to complete the RAID SAFE synchronization is based upon total hard drive capacity. Though the time to synchronize may take several hours, you can begin using the volume immediately by initializing it with your operating system's disk utility (see [Formatting](#)).

Performance may be affected during RAID synchronization.

Automatic power off and RAID SAFE synchronization

In general, the LaCie 2big powers off when the computer is shut down. However, the device remains powered on if it is in the midst of a RAID SAFE synchronization.

FORMATTING

ABOUT FILE SYSTEM FORMATS

Mac Users

You can customize the storage device by reformatting and/or partitioning it with separate file system formats. For optimal performance in Mac OS environments, format and partition the storage device as one large Mac OS Extended volume.

Mac OS Extended (HFS+): Mac OS Extended refers to the file system used by Mac OS X. HFS+ represents an optimization of the older HFS file system by using hard disk space more efficiently. With HFS+, you are no longer limited by block size.

FAT32: FAT32 is an older format with a maximum single file size limited to 4GB. Since performance is far from optimal, use FAT32 only if you are going to share your LaCie storage device between Mac and Windows computers.

See the table below for a comparison between HFS+ and FAT32.

Mac File System Formats
Use HFS+ if:
...you will be using the storage device on Macs only. Performance is far superior when compared to FAT32. HFS+ is NOT compatible with Windows.
Use FAT32 if:
...you will be using your storage device with both Windows and Mac computers.

Windows Users

FAT32: FAT is an acronym for File Allocation Table, which dates back to the beginnings of DOS programming. Originally, FAT was only 16 bits, but after the second release of Windows 95 it was upgraded to 32 bits, hence the name FAT32.

FAT32 is supported by Windows 7 and Windows 8 but the volume size is limited to 32GB and the individual file size is limited to 4GB.

Technical info: FAT32 can reduce the performance of your LaCie product.

NTFS: This acronym stands for New Technology File System, and it is the native file system for Windows 7 and Windows 8. NTFS offers several features that are not available with FAT32: file compression, encryption, permissions, auditing, and mirroring drives. The minimum supported volume size for NTFS is 10MB with a maximum of 2TB when initialized in the MBR format. For greater flexibility, use the GPT format with NTFS to remove limits on file and partition sizes. Volumes created in NTFS are native read and write for Windows 7 and Windows 8. Mac OS X 10.5 or higher can read and write to the NTFS partitions with the help of third-party drivers.

See the table below for a comparison of NTFS and FAT32.

Windows File System Formats
Use NTFS if:
...you will be using the storage device only with Windows 7 and Windows 8. NTFS performance is significantly better than FAT32. This file system is also compatible in read-only mode with Mac OS 10.3 and higher.
Use FAT32 if:
...you will be using your storage device with both Windows and Mac computers. Maximum single file size is limited to 4GB and performance is far from optimal.

FORMATTING INSTRUCTIONS

The steps listed below will help you to format and partition a storage device. For more information on choosing the optimal file format, refer to **About File System Formats**.

Caution: Formatting will erase everything on the storage device. **LaCie highly recommends that you back up all data on your storage device before performing the steps below. LaCie is not responsible for any data lost due to formatting, partitioning, or using a LaCie storage device.**

Important Info: Formatting the **LaCie** partition will delete the included User Manual and utilities. Copy all data, including documentation and software from the LaCie partition, before formatting your storage device. User Manuals and select software may also be downloaded from www.lacie.com/support/.

Note: Refer to your operating system's documentation for more information on formatting and partitioning your storage device.

Windows Users

1. Make sure the storage device is connected to and mounted on the computer.
2. Right-click on **Computer** and choose **Manage**. From the Manage window select **Disk Management**.
3. From the list of storage devices in the middle of the Disk Management window, locate your LaCie device.
4. By default, a partition is already created on the device with LaCie software utilities. Follow your operating system instructions to reset the existing partition.
5. To create a new partition, select **New Simple Volume**. Follow the on-screen instructions when the New Simple Volume Wizard appears.

Mac Users

1. Make sure the storage device is connected to and mounted on the computer.
2. Select **Utilities** from the **Go** menu in the Finder menu bar.
3. In the Utilities folder, double-click **Disk Utility**.

Disk Utility will display the message **Select a disk, volume, or image**. All connected storage devices, partitions, or disk images will be displayed in this column. Storage devices in this column may have multiple listings. The top name is the name of the physical device's manufacturer, and includes the formatted capacity.

4. Select the storage device in the left-hand column.
5. Click the **Erase** tab.
6. Choose a format from the drop-down window. See **About File System Formats** for more information on choosing a file format.
7. Give the volume a name.
8. Click **Erase...** and confirm your selection in the popup window.

REMOVING AND REPLACING A HARD DRIVE

Important info: Your LaCie professional DAS gives you instant updates on the health of the enclosure and its hard drives. In addition to LED status indications, you can configure the system to send you email alerts (see [LaCie Desktop Manager](#)). It is highly recommended that you address all warnings and alerts immediately. Ignoring a potential problem or urgent hardware alert can lead to irreparable damage to the DAS and a serious loss of data.

REMOVING A HARD DRIVE

RAID FAST

Important info: LaCie is not responsible for any lost data and cannot guarantee that your data will be saved by following these steps.

If you remove a hard drive from an unprotected array when the LaCie 2big is powered on, **you can lose all your data**. If one of the drives in RAID FAST mode has been removed and the front LED turns solid red, try the following:

1. Power off the device using a long press on the front LED button or unplug the power cable from the device.
2. Eject and reinsert the hard drive with the red LED.
3. Wait 10 seconds and, if applicable, connect the power cable to the device.
4. Power on the LaCie 2big by pressing the front LED button.

Important info: Adding hard drives that are part of LaCie 2big RAID FAST array to another enclosure or, directly to a computer, will corrupt data.

RAID SAFE

You can replace one drive from a protected array while the device is powered on without losing data. This process is referred to as “hot-swapping” and can be performed when a hard drive in a protected array has failed (see [LEDs and LED Power Button](#) for health indications).

RAID JBOD

Each hard drive in JBOD mode is treated as a separate volume. Therefore, removing one of the hard drives is similar to disconnecting a standard plug and play hard drive. Before removing a hard drive, make certain to eject its volumes from your computer. For instructions on how to properly eject a hard drive, see [Unmounting Your Drive](#).

When removing one drive improperly, it is likely that both volumes will unmount at the same time. However, the volume for the hard drive that is within its slot will reappear.

REPLACING A HARD DRIVE

The front LED lets you know the state of a RAID array.

- Solid blue: the RAID is healthy.
- Blinking red (SAFE only): the RAID is degraded.
- Solid red: the RAID is broken.

The drive LED for the failed hard drive will turn red or turn off, allowing you to identify the drawer that must be replaced. Drive LEDs are on the top end of the drawer.

Important info: Contact your LaCie reseller or LaCie technical support if a hard drive or part fails. LaCie 2big enclosures, drives, and parts that experience failure and are within the warranty period must be replaced by equivalent replacement parts from LaCie. Installing third-party drives and parts will void the warranty.

RAID SAFE: degraded versus broken

A degraded RAID SAFE means that one of the hard drives has failed and that RAID protection is not in effect. However, your data remains intact on the healthy hard drive and you can continue to use the device. RAID protection will take effect once the replacement hard drive is installed and the array has completed data synchronization.

A broken RAID SAFE means that both hard drives have failed or, a hard drive has failed during RAID synchronization. All data is lost if the RAID is broken.

Remove the failed hard drive

Important info: DO NOT remove the failed hard drive before receiving the replacement hard drive from LaCie. Both drive trays must remain in the enclosure for proper airflow.

Caution: After continuous use of the product, the hard drives may be hot. Use caution when opening a drive bay and removing a hard drive.

1. Place your finger on the indent on top of the drive bay handle and gently pull it away from the LaCie 2big.

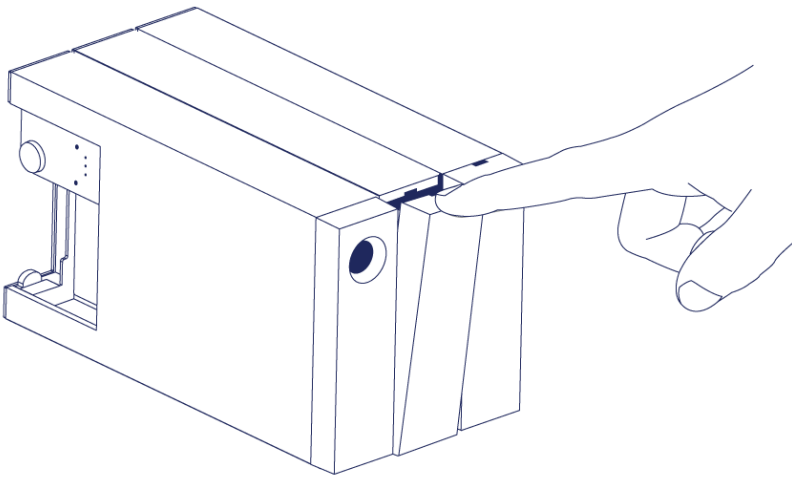

2. Grasp the drive tray handle and carefully extract the hard drive. Place the hard drive tray on a flat, even surface.

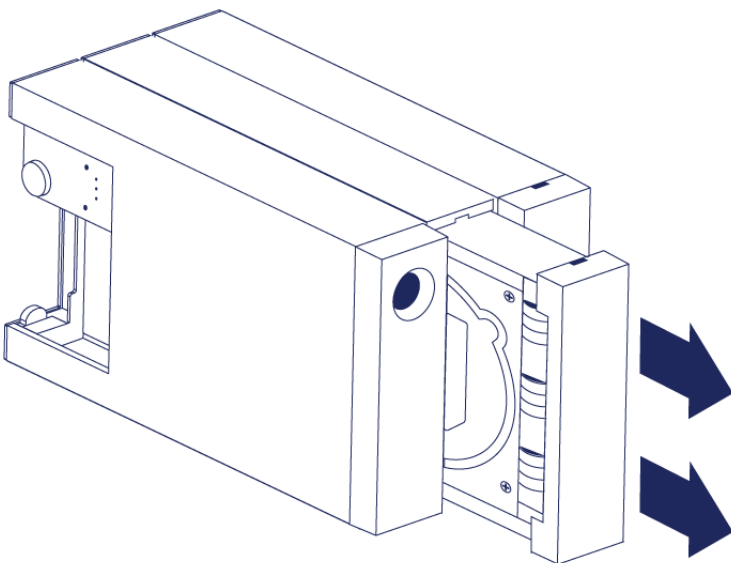

Install the replacement hard drive

Important info: A failed hard drive within the warranty period must be swapped with a replacement hard drive from LaCie. Replacement hard drives for the LaCie 2big are shipped within the tray.

The steps below can be performed while the enclosure is powered on or powered off.

1. Before touching the replacement hard drive, make certain that you are properly grounded to avoid electrostatic discharge.
2. Carefully insert the replacement hard drive tray into the empty hard drive bay. You will feel a bit of resistance when the drive tray is almost flush. Gently push the drive tray handle until it snaps into place.

STATUS FOLLOWING A HARD DRIVE SWAP

Refer to the table below for the RAID behavior following a hard drive swap:

RAID Mode	Data	Status
FAST	All data has been lost with the hard drive failure.	The LaCie 2big recreates FAST mode with the new hard drive and your operating system prompts you to format the volume.
SAFE	Data is protected on the healthy hard drive.	The LaCie 2big synchronizes the data with the new hard drive.
JBOD	All data stored on the failed hard drive is lost. Data on the healthy hard drive remains accessible.	The LaCie 2big maintains the JBOD configuration; your operating system prompts you to format the replacement hard drive.

RAID configuration times

The table below provides estimated times to configure the RAID.

RAID	Time to complete
FAST	Less than a minute
SAFE	Several hours to one or more days (see note below)
JBOD	Less than a minute

The time to complete the RAID SAFE synchronization is based upon total hard drive capacity. Though the time to synchronize may take several hours, you can begin using the volume immediately by initializing it with your operating system's disk utility (see [Formatting](#)).

Performance may be affected during RAID synchronization.

Automatic power off and RAID SAFE synchronization

In general, the LaCie 2big powers off when the computer is shut down. However, the device remains powered on if it is in the midst of a RAID SAFE synchronization.

UNMOUNTING YOUR DRIVE

USB, FireWire, Thunderbolt, and eSATA external devices feature “plug & play” connectivity, which means that your LaCie storage can be connected and disconnected while the computer is running. To prevent failures, however, it is important to follow these steps when disconnecting your device.

MAC

Drag the storage device icon to the Trash. (The icon pictured below is a generic USB device icon. Your LaCie storage may be represented by an icon that looks like the device itself.)

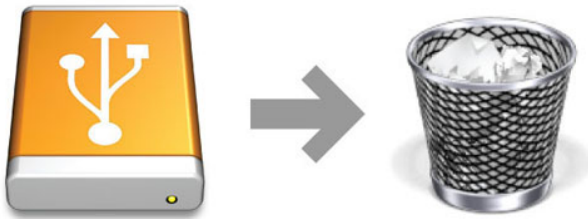

When the icon disappears from the desktop, the storage device can be disconnected.

WINDOWS 7 AND WINDOWS 8

From the System Tray (located in the lower right-hand side of your screen) click on the plug icon (note the white check mark inside a green circle).



A message will appear, detailing the devices that may be safely unmounted.

Select **Eject** for the device you wish to unmount. A message will appear notifying you that it is safe to remove it.

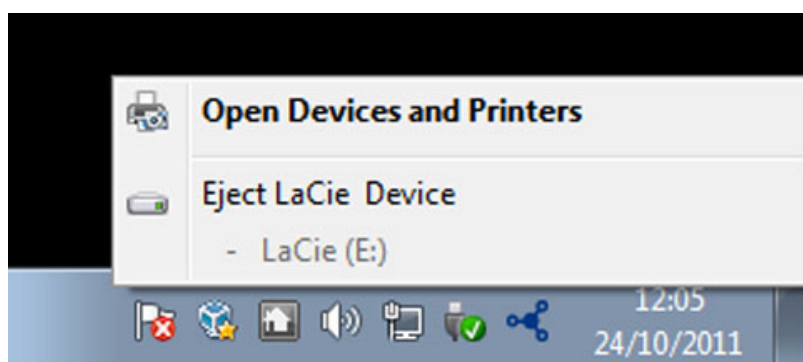

GETTING HELP

If you are having problems with your LaCie product, consult the table below for a list of available resources.

Order	Source	Description	Location
1	Quick Install Guide	Concise steps to follow for getting your product up and running	Either a printed leaflet or accessory box and included in the product box, or download PDF from the product page
2	Support Pages	Includes interactive troubleshooting topics for most common problems	www.lacie.com/support/ , select your product, then click the "Troubleshooting" tab
3	User Manual	Includes common troubleshooting topics	See Troubleshooting Topics below
4	Customer Support	Create an account on lacie.com , register your product, and fill out a support ticket	Create an account here: www.lacie.com/us/mystuff/login.htm?logout&rtm=mystuff

Note: LaCie is dedicated to providing high quality products that enrich the lives of our customers. To help LaCie offer the best customer support, we encourage you to create an account and register your product at www.lacie.com/us/mystuff/login.htm?logout&rtm=mystuff. You can give us important feedback as well as receive updated information on your LaCie device.

TROUBLESHOOTING TOPICS

Note: Interactive troubleshooting, a highly effective way to resolve problems with your product, is available from www.lacie.com/support/. Select your product, then click the “Troubleshooting” tab.

Thunderbolt 2 connection (Mac)

Problem: I do not see the LaCie 2big when using the Thunderbolt 2 port.

Q: Are there other Thunderbolt technology devices connected to the same port?

A: Disconnect other Thunderbolt devices and see if the volume appears on the desktop.

Q: Does the icon/Do the icons for the volumes appear on the desktop?

A: The drive icons for the storage should appear on your desktop. Confirm that the Finder preference for displaying external hard drives on the desktop is selected at **Finder > Preferences > General..**

Q: Is the enclosure connected to a computer that supports Thunderbolt 2 technology or first generation Thunderbolt technology?

A: The connection type for Thunderbolt technology on the Mac is the Mini DisplayPort. While earlier Macintosh computers include one or more Mini DisplayPorts, they are only used to connect one or more monitors. Legacy Macs with Mini DisplayPorts do not support Thunderbolt technology peripherals.

Q: Did you follow the correct installation steps?

A: Review the installation steps ([Getting Connected](#)) and make certain that: both ends of the Thunderbolt technology cable are firmly connected to the ports; and, that the device is receiving power via the included power supply.

Q: I connected the enclosure to my computer with an older Mini DisplayPort cable that I use for my monitors. Why can't I see the volumes on the desktop?

A: The storage requires a cable specifically constructed for Thunderbolt technology. Use the Thunderbolt cable shipped with your LaCie device.

Q: I connected a cable that supports Thunderbolt technology to my computer but the enclosure does: (a.) not power on and/or (b.) not receive sufficient power.

A: Thunderbolt enclosures must also receive power via the included power supply. See [Getting Connected](#).

Q: Are both ends of the Thunderbolt technology cable securely attached?

A:

- Only use the included Thunderbolt cable.
- Check both ends of the Thunderbolt technology cable to make sure they are fully seated in their respective ports.
- Try disconnecting the Thunderbolt technology cable then wait 10 seconds before reconnecting it.
- If the drive is still not recognized, restart your computer and try again.

USB 3.0 connection (PC/Mac)

Problem: My file transfers are too slow.

Q: Are there other USB devices connected to the same port or hub?

A: Disconnect any other USB devices and see if the drive's performance increases.

Q: Is the device connected to a USB 2.0 port on your computer or hub?

A: If the LaCie 2big is connected to a USB 2.0 port or hub, this is normal. A SuperSpeed USB 3.0 device can only operate at USB 3.0 performance levels when it is connected to a computer with a USB 3.0 port. Otherwise, the USB 3.0 device will operate at the slower USB transfer rates.

Q: Is the LaCie 2big connected to a SuperSpeed USB 3.0 port on your computer?

A: Third-party USB 3.0 adapters: Check to see that the SuperSpeed USB 3.0 drivers for your host bus adapter has been installed correctly. If in doubt, uninstall the drivers and re-install them.

Q: Does your computer or operating system support SuperSpeed USB 3.0?

A: Refer to the product packaging or consult the product support web page at www.lacie.com/support/ to check the minimum system requirements.

Q: Do you require additional drivers for USB 3.0?

A: Certain versions of Windows require additional drivers to support USB 3.0.

Q: Is your computer's internal hard drive limiting transfer speeds?

A: If your computer has a low-performance internal hard drive (typically a notebook or netbook computer), it can limit the transfer speed.

General

Problem: I'm receiving file transfer error messages and Time Machine does not work.

Q: Did you get an "Error -50" message while copying to the storage?

A: When copying files or folders from a computer to a FAT32 volume, certain characters cannot be copied. These characters include, but are not limited to:

? < > / \ :

Since it does not offer optimal performance, LaCie does not recommend using the FAT32 file system with Thunderbolt 2 and/or USB 3.0 storage. Consider formatting the hard drive as HFS+ Journaled with a Striped or Mirrored RAID Set. See [Formatting](#). Additionally, Time Machine is only compatible with hard drives formatted in HFS+ or HFS+Journaled. If necessary, reformat the hard drive for Time Machine compatibility.

Q: Did you get an error message telling you that the hard drive has been disconnected when coming out of sleep mode?

A: Ignore this message. The hard drive will remount to the desktop.

Problem: The hard drive space does not seem right.

Q: I just threw a lot of files into the Trash from my LaCie storage device. Why don't I see more space to copy new files?

A: Hard drive space will not be reclaimed until files are deleted or emptied from the Trash.

Q: Why is the volume capacity less than advertised?

A: After formatting, the available capacity of a hard drive will show less than advertised on the box. The difference is based upon how capacity is viewed by the operating system. For example, a hard drive that can store 500,000,000,000 bytes is divided by 1,000,000,000 to equal 500GB. This is the actual capacity listed on the manufacturer's box. The operating system uses slightly different math, dividing 500,000,000,000 by 1,073,741,824 to equal 466GB.

Problem: I have to rebuild the RAID SAFE.

Q: I just received my replacement hard drive from LaCie. How do I rebuild my RAID SAFE?

A: See [Removing and Replacing a Hard Drive](#) for instructions on how to replace the hard drive and [Manage RAID](#) if you want to change the RAID mode.

PRECAUTIONS

Caution: It is essential that you use only the power supply that shipped with your product, since it is a shielded-type power cord that meets FCC emission limits as well as to prevent interference to the nearby radio and television reception.

Caution: Modifications not authorized by the manufacturer may void the user's authority to operate this device.

Important info: Any loss, corruption or destruction of data while using a LaCie drive is the sole responsibility of the user, and under no circumstances will LaCie be held liable for the recovery or restoration of this data. To help prevent the loss of your data, LaCie highly recommends that you keep TWO copies of your data; one copy on your external hard disk, for instance, and a second copy either on your internal hard disk, another external hard disk or some other form of removable storage media. If you would like more information on backup, please refer to our website.

Important info: 1TB (Terabyte) = 1,000GB. 1GB = 1000MB. 1MB = 1,000,000 Bytes. Total accessible capacity varies depending upon operating environment (typically up to 10% less per TB).

HEALTH AND SAFETY PRECAUTIONS

- Only qualified persons are authorized to carry out maintenance on this device.
- Read this User Manual carefully and follow the correct procedure when setting up the device.
- Do not open a disk drive or attempt to disassemble or modify it. Never insert any metallic object into the drive to avoid any risk of electrical shock, fire, short-circuiting or dangerous emissions. The disk drive shipped with your LaCie hard drive contains no user-serviceable parts. If it appears to be malfunctioning, have it inspected by a qualified LaCie Technical Support representative.
- Never expose your device to rain, or use it near water, or in damp or wet conditions. Never place objects containing liquids on the LaCie hard drive, as they may spill into its openings. Doing so increases the risk of electrical shock, short-circuiting, fire or personal injury.

GENERAL USE PRECAUTIONS

- Power requirements 100-240 V~, 50-60 Hz, (supply voltage fluctuations not exceeding $\pm 10\%$ of the nominal and transient over-voltages according to over-voltage category II).
- Do not expose the LaCie hard drive to temperatures outside the range of 5° C to 30° C (41° F to 86° F); or to operational humidity beyond 10-80%, non-condensing, or non-operating humidity beyond 10-90%, non-condensing. Doing so may damage the LaCie hard drive or disfigure its casing. Avoid placing your LaCie

hard drive near a source of heat or exposing it to sunlight (even through a window). Inversely, placing your LaCie hard drive in an environment that is too cold may damage the unit.

- Rated cooling for altitudes up to 2000 meters.
- If your drive features a power cable, always unplug it from the electrical outlet if there is a risk of lightning or if it will be unused for an extended period of time. Otherwise, there is an increased risk of electrical shock, short-circuiting or fire.
- Use only the power supply shipped with the device (if applicable).
- Do not use the LaCie hard drive near other electrical appliances such as televisions, radios or speakers. Doing so may cause interference which will adversely affect the operation of the other products.
- Do not place the LaCie hard drive near sources of magnetic interference, such as computer displays, televisions or speakers. Magnetic interference can affect the operation and stability of your LaCie hard drive.
- Never use excessive force on your LaCie hard drive. If you detect a problem, consult the troubleshooting section in this manual.
- Protect your LaCie hard drive from excessive exposure to dust during use or storage. Dust can build up inside the device, increasing the risk of damage or malfunction.
- Never use benzene, paint thinners, detergent or other chemical products to clean the outside of the LaCie hard drive. Such products will disfigure and discolor the casing. Instead, use a soft, dry cloth to wipe the device.

WARRANTY INFORMATION

LaCie offers first-rate service and support through our generous three-tiered warranty policy. Our 1-, 2-, 3-, and 5-year policies include comprehensive, complimentary web-based resources, expert in-house technical support, and worldwide repair and/or replacement coverage. To benefit from this warranty, please contact LaCie Support at www.lacie.com/us/support where you can find online support and contact information. You may also contact representatives at the original point of purchase who will be able to help guide you.

Standard warranties vary depending on the product. To verify your product's warranty status and to see which standard warranty is included with your product, type in your product's serial number at www.lacie.com/us/support. If no warranty is listed under your product's name, this means that the warranty has expired.

WARRANTY UPGRADES

If you wish to extend your warranty coverage, you can purchase Silver, Gold, or Platinum Care or Advanced Exchange. For details, see www.lacie.com/warranties.

LEGAL INFORMATION

A standard LaCie limited warranty is included with all products. Please read the terms and conditions below.

LaCie Limited Warranty Policy

LaCie ("LaCie") warrants, to the original purchaser, that this equipment shall be free of defects in materials and workmanship for a period of one (1), two (2), three (3), or five (5) years, depending on the model, from LaCie's date of original shipment when the equipment is used normally and is properly serviced when needed. If you discover a defect covered by the warranty set forth above, your sole and exclusive remedy will be for LaCie, in its sole discretion to (i) repair or replace the product at no charge to you; or, if a repaired unit or replacement product is not available, (ii) to refund the current market value of your product. You acknowledge and agree that replacement product, at the sole option of LaCie, may be a new product or a remanufactured product. In order to receive the remedy set forth above, you must return the product during the warranty period and include with each returned product (i) a copy of your original purchase invoice to verify your warranty; (ii) a Return Material Authorization number; (iii) your name, address and telephone number; (iv) a copy of the bill of sale bearing the appropriate LaCie serial numbers as proof of date of original retail purchase; and (v) a description of the problem. The customer must pay all transportation costs for a returned product. The product will need to be returned to LaCie within the country of original retail purchase. This warranty applies only to hardware products; LaCie software, media, and manuals are licensed and warranted pursuant to separate written agreement. This warranty does not apply if the product has been misused or has been damaged by accident, abuse, misuse, or misapplication; if it has been modified without permission of LaCie; or if any LaCie serial number has been removed or defaced. If a customer has purchased a LaCie Advance Care Option (ACO) to go with this equipment, the ACO shall be valid for three (3) years from activation.

EXCEPT FOR THE LIMITED WARRANTY SET FORTH ABOVE, ALL PRODUCTS ARE SOLD “AS IS” AND LACIE EXPRESSLY DISCLAIMS ALL WARRANTIES OF ANY KIND, WHETHER EXPRESS, IMPLIED OR STATUTORY, INCLUDING THE IMPLIED WARRANTIES OF MERCHANTABILITY, NONINFRINGEMENT AND FITNESS FOR A PARTICULAR PURPOSE. WITHOUT FURTHER LIMITING THE GENERALITY OF THE FOREGOING, DOES NOT WARRANT (1) THE PERFORMANCE OR RESULTS OBTAINED FROM USING THIS PRODUCT, (2) THAT THE PRODUCT IS APPROPRIATE FOR THE CUSTOMER'S PURPOSES, (3) THE MANUAL IS ERROR FREE, OR (4) THAT NO DATA WILL BE LOST WHILE USING THE PRODUCT. THE ENTIRE RISK AS TO THE RESULTS AND PERFORMANCE IS ASSUMED BY THE CUSTOMER. THE WARRANTY AND REMEDIES SET FORTH ABOVE ARE EXCLUSIVE AND IN LIEU OF ALL OTHERS, ORAL OR WRITTEN, EXPRESS OR IMPLIED.

EXCLUSIONS AND LIMITATIONS

This Limited Warranty applies only to hardware products manufactured by or for LaCie that can be identified by the “LaCie” trademark, trade name, or logo affixed to them. The Limited Warranty does not apply to any non-LaCie hardware products or any software, even if packaged or sold with LaCie hardware. Manufacturers, suppliers, or publishers, other than LaCie, may provide their own warranties to the end user purchaser, but LaCie, in so far as permitted by law, provides their products “as is”. Software distributed by LaCie with or without the LaCie brand name (including, but not limited to system software) is not covered under this Limited Warranty. Refer to the licensing agreement accompanying the software for details of your rights with respect to its use.

LaCie does not warrant that the operation of the product will be uninterrupted or error-free. LaCie is not responsible for damage arising from failure to follow instructions relating to the product's use. This warranty does not apply: (a) to consumable parts, unless damage has occurred due to a defect in materials or workmanship; (b) to cosmetic damage, including but not limited to scratches, dents and broken plastic on ports; © to damage caused by use with non-LaCie products; (d) to damage caused by accident, abuse, misuse, flood, fire, earthquake or other external causes; (e) to damage caused by operating the product outside the permitted or intended uses described by LaCie; (f) to damage caused by service (including upgrades and expansions) performed by anyone who is not a representative of LaCie or a LaCie Authorized Service Provider; (g) to a product or part that has been modified to alter functionality or capability without the written permission of LaCie; or (h) if any LaCie serial number on the product has been removed or defaced.

No LaCie dealer, agent, or employee is authorized to make any modification, extension, or addition to this warranty.

Any loss, corruption or destruction of data while using a LaCie drive is the sole responsibility of the user, and under no circumstances will LaCie be held liable for the recovery or restoration of this data. To help prevent the loss of your data, LaCie highly recommends that you keep TWO copies of your data; one copy on your external hard disk, for instance, and a second copy either on your internal hard disk, another external hard disk or some other form of removable storage media. LaCie offers a complete line of CD and DVD drives. If you would like more information on backup, please refer to our website.

LACIE IS NOT RESPONSIBLE FOR SPECIAL, INCIDENTAL, OR CONSEQUENTIAL DAMAGES RESULTING FROM ANY BREACH OF WARRANTY, OR UNDER ANY LEGAL THEORY, INCLUDING LOST PROFITS, DOWNTIME, GOODWILL, DAMAGE TO OR REPLACEMENT OF EQUIPMENT AND PROPERTY, AND ANY COSTS OF RECOVERING, REPROGRAMMING, OR REPRODUCING ANY PROGRAM OR DATA STORED IN OR USED WITH LACIE PRODUCTS EVEN IF IT HAS BEEN ADVISED OF THE POSSIBILITY OF SUCH DAMAGES.

Some states do not allow the exclusion or limitation of implied warranties or liability for incidental or consequential damages, so the above limitation or exclusion may not apply to you. This warranty gives you specific legal rights, and you may have other rights, which vary from state to state.

Your opening of your package, your use of the product, or your return of the enclosed Registration Card acknowledges that you have read and agree to the terms of this Agreement. You further agree that it is the complete and exclusive state of the agreement between us and supersedes any proposal or prior agreement, oral or written, and any other communications between us relating to the subject matter of this Agreement.

Read carefully all information related to warranty and precautions of use of your new LaCie product in the user manual.

For products purchased in the United States, you may contact LaCie at 22985 NW Evergreen Parkway, Hillsboro, Oregon 97124. Email: sales@lacie.com. Website: www.lacie.com. Customer service: 503-844-4503.

Service DOA

On rare occasions, a newly purchased LaCie product may be delivered in non-working order. We are working to avoid these issues, but unfortunately, these situations may arise from time to time. Within the 15 calendar days of purchase, should you experience an issue with your new LaCie product, we ask you to return the product to the place where it was originally bought. You will be required to give a proof of purchase.

Customer Warning

Please be sure to back up your data before returning your drive to LaCie for repair. LaCie cannot under any circumstances guarantee the integrity of data remaining on a returned drive. We make no provisions for data recovery and cannot be held liable for any data loss on drives or media returned to LaCie.

All products returned to LaCie must be securely packaged in their original box and shipped with postage prepaid, except for Products registered under the Advance Care Option.

NOTE TO AUSTRALIAN CUSTOMERS

Our goods come with guarantees that cannot be excluded under the Australian Consumer Law. You are entitled to a replacement or refund for a major failure and for compensation for any other reasonably foreseeable loss or damage. You are also entitled to have the goods repaired or replaced if the goods fail to be of acceptable quality and the failure does not amount to a major failure.

Contact us:

LaCie Australia, 458 Gardeners Road Alexandria, NSW 2015 AUSTRALIA.

Phone: 02 8063 3711

Email: info.au@lacie.com

For fast technical support, create a support ticket after registering your product at www.lacie.com/au/register.

LEGAL INFORMATION

COPYRIGHTS

Copyright © 2014 LaCie. All rights reserved. No part of this publication may be reproduced, stored in a retrieval system, or transmitted in any form or by any means, electronic, mechanical, photocopying, recording or otherwise, without the prior written consent of LaCie.

CHANGES

The material in this document is for information only and subject to change without notice. While reasonable efforts have been made in the preparation of this document to assure its accuracy, LaCie assumes no liability resulting from errors or omissions in this document, or from the use of the information contained herein. LaCie reserves the right to make changes or revisions in the product design or the product manual without reservation and without obligation to notify any person of such revisions and changes.

FEDERAL COMMUNICATION COMMISSION INTERFERENCE STATEMENT

This equipment has been tested and found to comply with the limits for a Class B digital device, pursuant to Part 15 of the FCC Rules. These limits are designed to provide reasonable protection against harmful interference in a residential installation. This equipment generates, uses and can radiate radio frequency energy and, if not installed and used in accordance with the instructions, may cause harmful interference to radio communications. However, there is no guarantee that interference will not occur in a particular installation. If this equipment does cause harmful interference to radio or television reception, which can be determined by turning the equipment off and on, the user is encouraged to try to correct the interference by one of the following measures:

1. Reorient or relocate the receiving antenna.
2. Increase the separation between the equipment and receiver.
3. Connect the equipment into an outlet on a circuit different from that to which the receiver is connected.
4. Consult the dealer or an experienced radio/TV technician for help.

FCC Caution: Any changes or modifications not expressly approved by the party responsible for compliance could void the user's authority to operate this equipment.

This device complies with Part 15 of the FCC Rules. Operation is subject to the following two conditions: (1) This device may not cause harmful interference, and (2) this device must accept any interference received, including interference that may cause undesired operation.

Important info: FCC Radiation Exposure Statement: This equipment complies with FCC radiation exposure limits set forth for an uncontrolled environment. This equipment should be installed and operated with minimum distance 20 cm between the radiator & your body.

This transmitter must not be co-located or operating in conjunction with any other antenna or transmitter. The availability of some specific channels and/or operational frequency bands are country dependent and are

firmware programmed at the factory to match the intended destination. The firmware setting is not accessible by the end user.

WEEE



This symbol on the product or on its packaging indicates that this product must not be disposed of with your other household waste. Instead, it is your responsibility to dispose of your waste equipment by handing it over to a designed collection point for the recycling of waste electrical and electronic equipment. The separate collection and recycling of your waste equipment at the time of disposal will help to conserve natural resources and ensure that it is recycled in a manner that protects human health and the environment. For more information about where you can drop off your waste equipment for recycling, please contact your local city office, your household waste disposal service, or the shop where you purchased the product.

MANUFACTURER'S DECLARATION FOR CE CERTIFICATION



We, LaCie, solemnly declare that this product conforms to the following European standards: Electromagnetic Compatibility Directive (2004/108/EC); Low-Voltage Directive: 2006/95/EC

TRADEMARKS

Apple, Mac, Time Machine, and Macintosh are registered trademarks of Apple Computer, Inc. Microsoft, Windows XP, Windows Vista, and Windows 7 are registered trademarks of Microsoft Corporation. Other trademarks mentioned in this manual are the property of their respective owners.

CANADA COMPLIANCE STATEMENT

This Class B digital apparatus meets all requirements of the Canadian Interference-Causing Equipment Regulations.

CAN ICES-3 (B)/NMB-3(B)

JAPAN COMPLIANCE STATEMENT

This is a Class B product based on the standard of the Voluntary Control Council for Interference from Information Technology Equipment (VCCI). If this is used near a radio/TV receiver, it may cause radio interference. Install the equipment according to the manual. This statement does not apply to the LaCie CloudBox.