

Two way speed strap

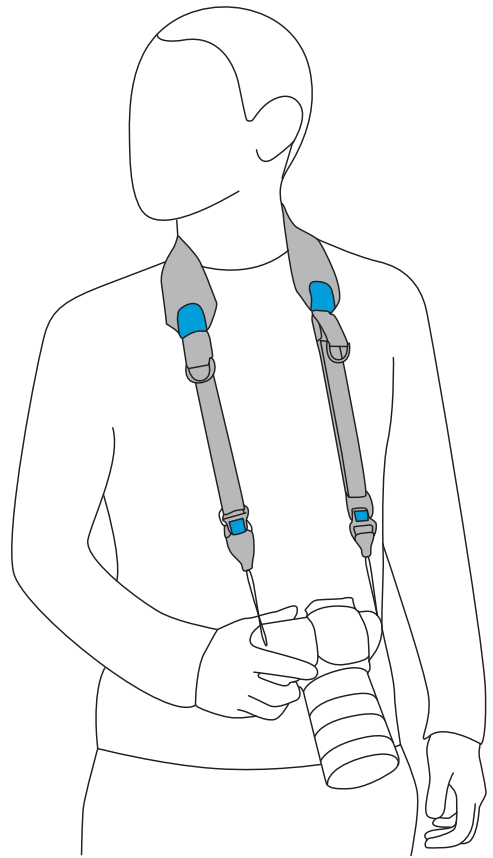

CLASSIC

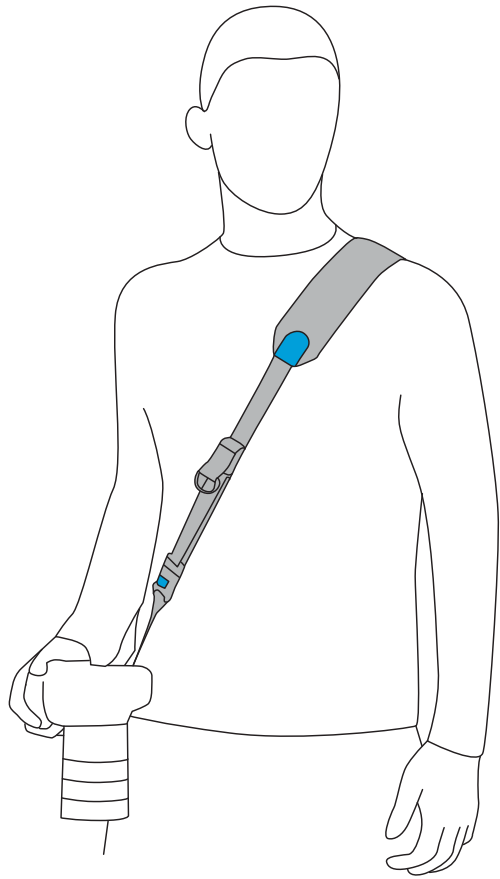

SLING

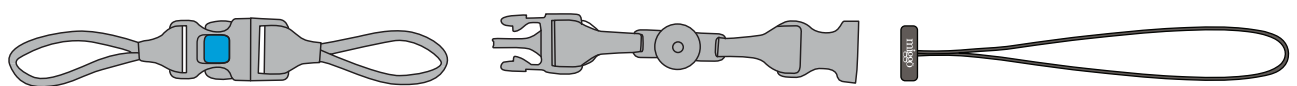
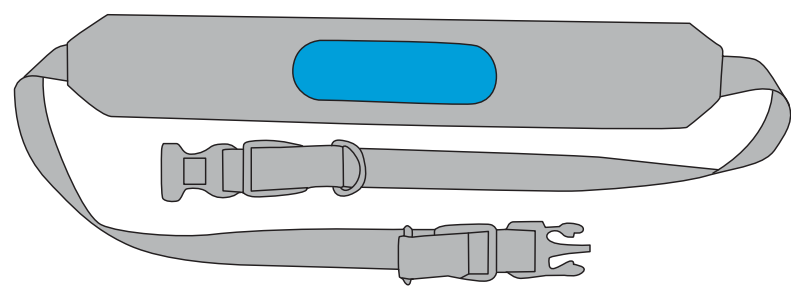

Two way speed strap



SLING

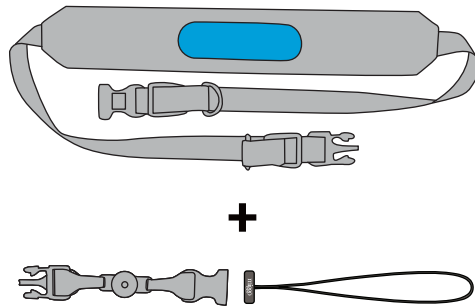
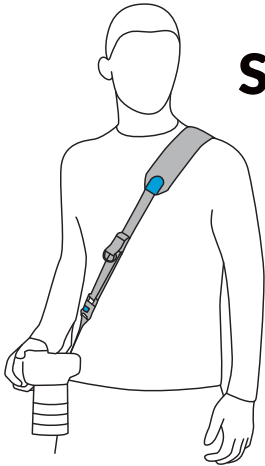

1

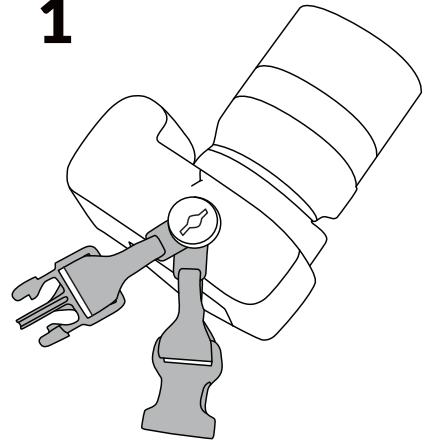

2

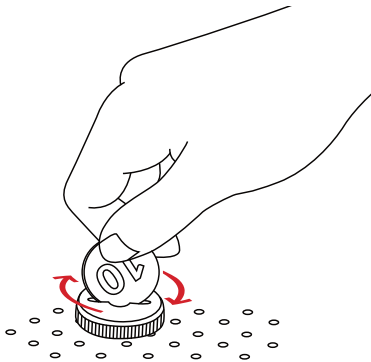

Attention!
Use a coin to tighten the screw to your camera.
Servez-vous d'une pièce de monnaie pour resserrer la vis qui permet de fixer miggo à votre appareil photo.

3

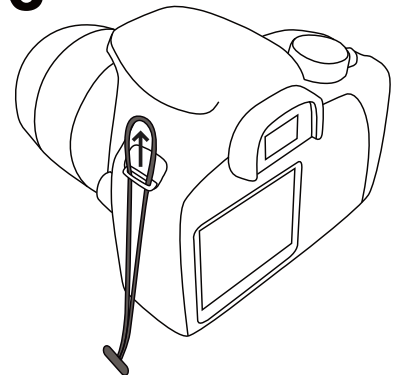

4

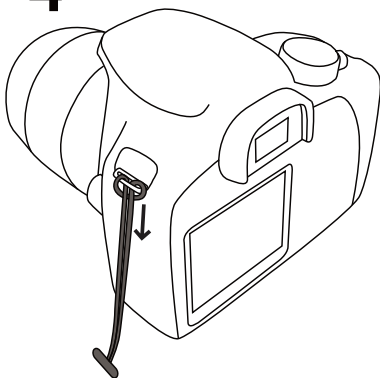

5

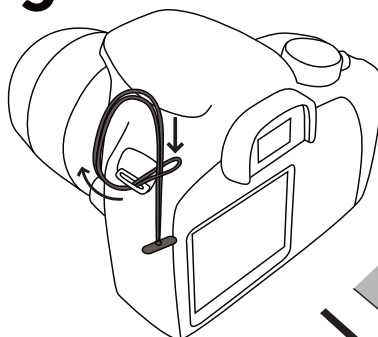

6

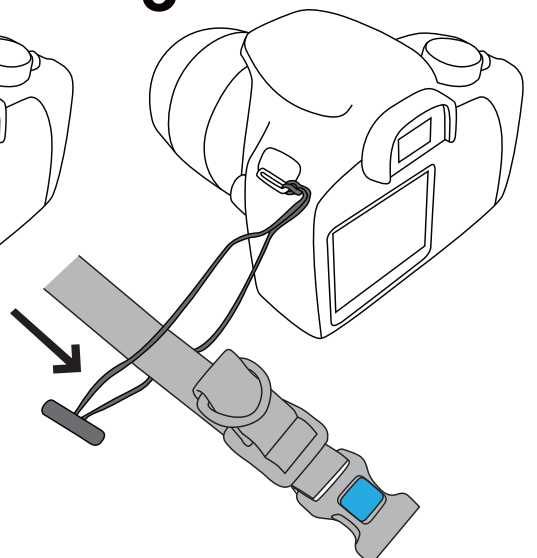

Two way speed strap

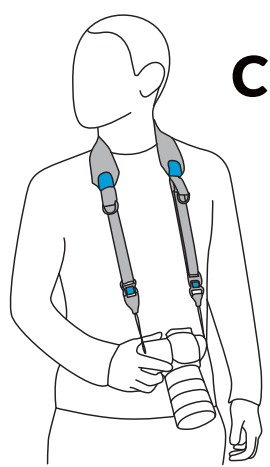
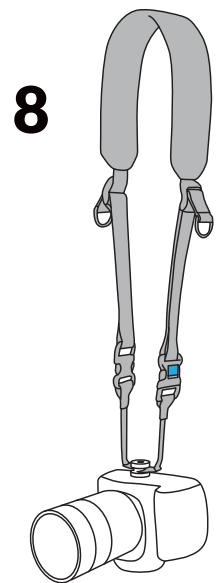
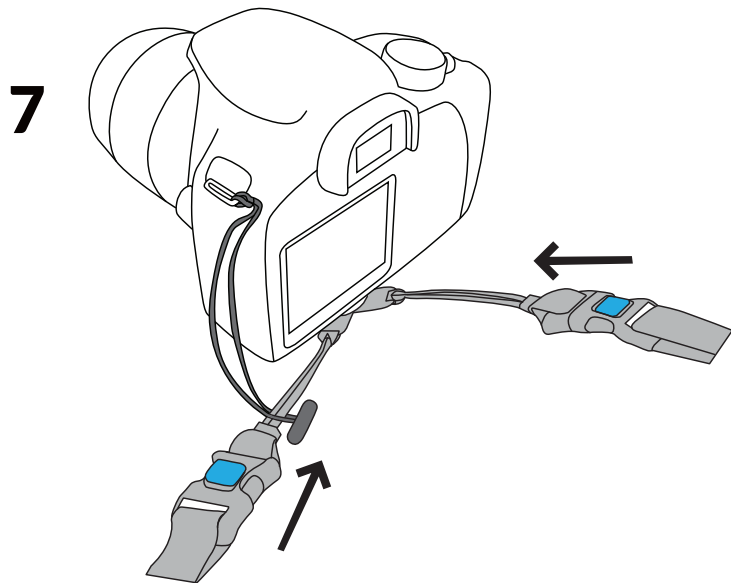

CLASSIC

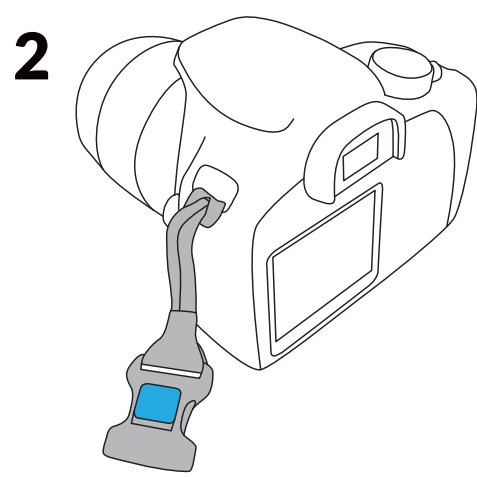
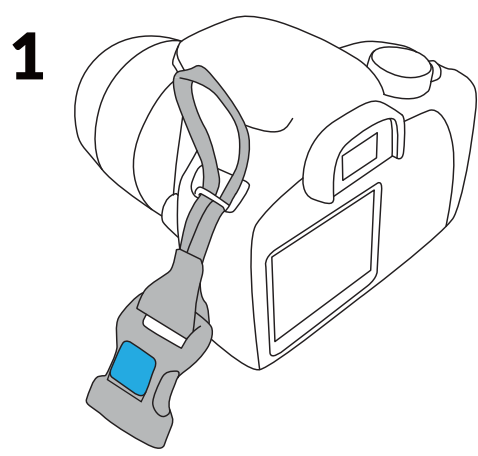
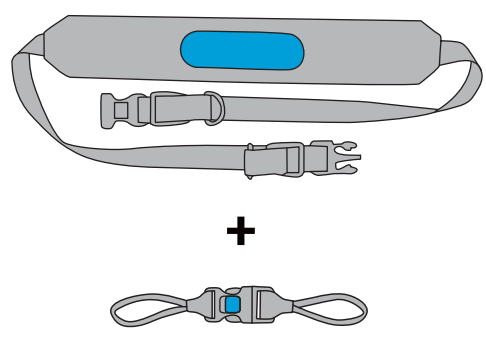

Two way speed strap



3

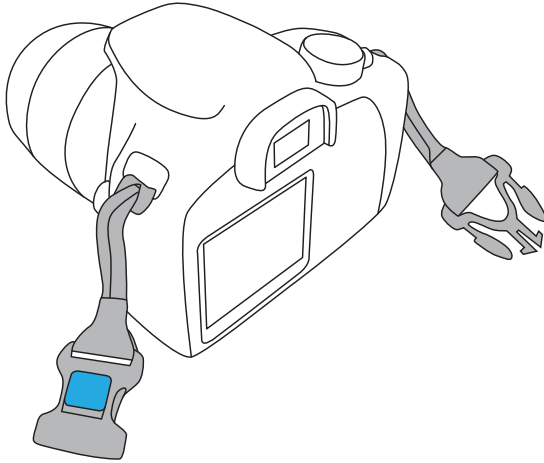

4

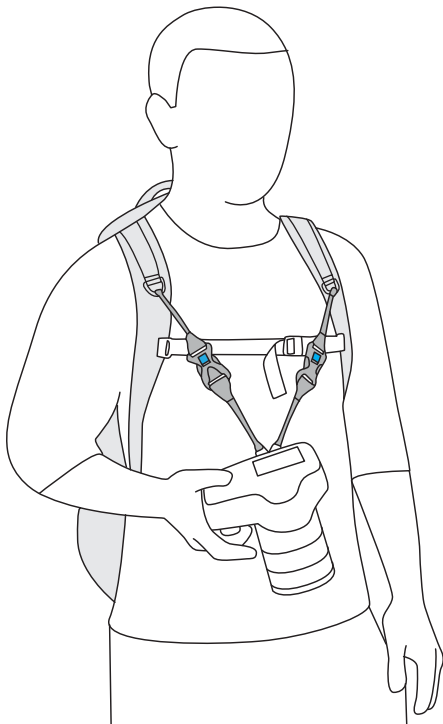
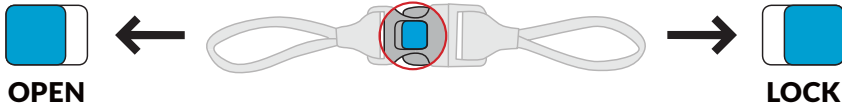
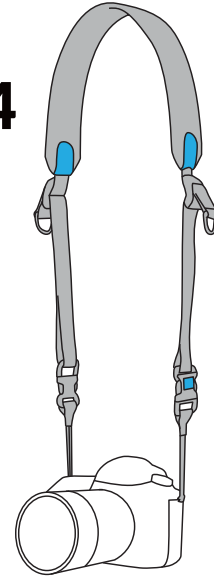

BACKPACK ATTACHMENT

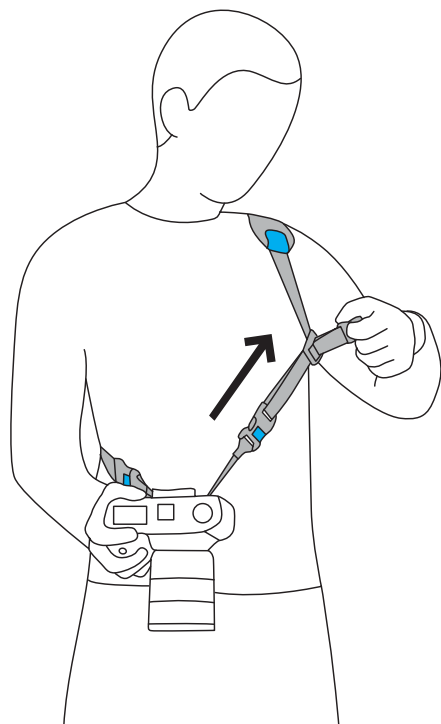

QUICK- ADJUSTMENT