

**Universal
Projector
Low Profile
Mount
MV-PROJSP-FLAT
BLACK**

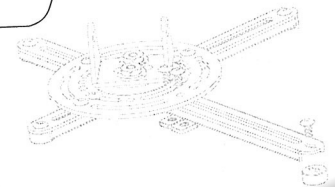
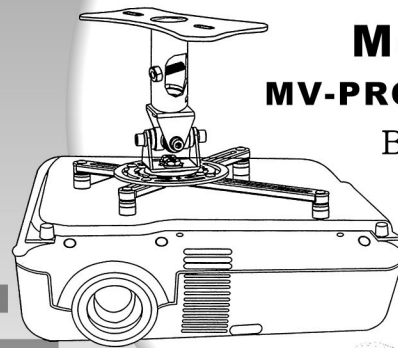

Important Notes

- Thank you for purchasing the Universal Projector Flush Mount. This bracket is suitable for about 80% to 90% of projectors up to 15kg (33lbs).
- To ensure correct usage, please read this instruction manual thoroughly. Keep this manual for future reference.
- Bracket should be mounted only by qualified installer.
- User will be responsible for any injuries and damages that may arise from improper installation and handling of Universal Ceiling Mounting Kit.
- Ensure all mounting screws are appropriately positioned and properly tightened/fastened.
- Installers are to ensure customer's safety during installation.
- We reserve the right to amend or undertake any necessary changes without prior notice.

WARNING

This symbol indicates the incorrect handling. Ignoring this symbol can result in the possibility of personal injury or even death.

CAUTION

This symbol indicates the incorrect handling. Ignoring this symbol can result in the possibility of personal injury and physical damage.

 This symbol indicates additional cautions (including warnings).

 This symbol indicates forbidden actions.

 This symbol indicates required actions.



Parts Specifications

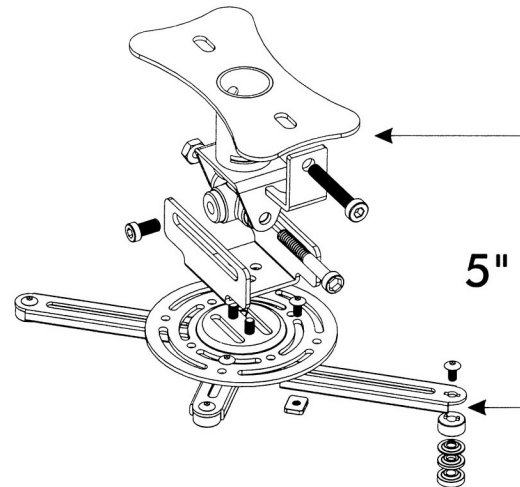

⚠ WARNING

- Assembling without the use of bolts and screws at designated points may result in injury and damage to properties or the unit collapsing from its installed position.
- When a malfunction occur, disconnect the power from the main socket and surround the area with ropes to prevent others from getting near it.
- Check and ensure the ceiling where you install can support the load of the unit and Ceiling Mounting.

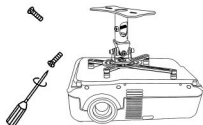

- Steps should be taken to ensure the ceiling and installed unit can withstand external forces like earthquakes, vibrations, etc.

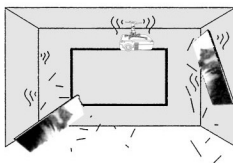

- All Ceiling Mounting Brackets are to be firmly secured so the unit will not drop off its installed position.

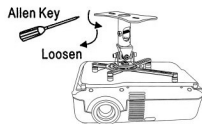

- Do not remove any bolts and screws from the Ceiling Mounting Brackets or do any changes to the Ceiling Mounting Brackets.



⚠ CAUTION

- Do not install near an air-conditioner.
- Do not install at place where there are excessive dust and smoke as fire could arise from these sources.

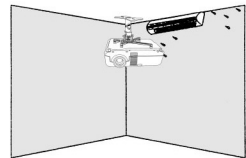

- Keep the room well ventilated to prevent room temperature rising and possibilities resulting in fire.

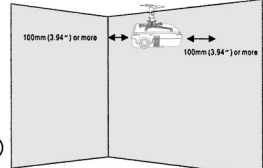

- Do not install in location where room temperature and humidity are excessively high to prevent fire.
- To prevent the fire, avoid contacting with water.

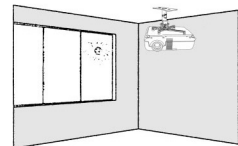

- Do not apply unnecessary stress or load on the installed unit.



Package Contents

1. Each package should contain the parts listed as shown below.

Part 1

Ceiling Plate ----- 1 pcs



Part 2

U-Brocket ----- 1 pcs

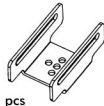

Part 3

Extension Bracket

50mm ----- 2 pcs
75mm ----- 2 pcs
100mm ----- 2 pcs
150mm ----- 2 pcs

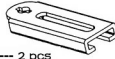

Part 4

General Base Plate ----- 1 pcs



Part 5

Cross Adapter ----- 1 pcs



Part 6

Shaft ----- 1 pcs



Part 7

Locking Hook ----- 1 pcs



Part 8

Truss Head Screw

M4x15 / M4x20 / M4x25 ----- 4 pcs each
M5x15 / M5x20 / M5x25 ----- 4 pcs each
M6x15 / M6x20 / M6x25 ----- 4 pcs each



Part 9

Socket Cap Screw
M8x15 ----- 2 pcs
M8x50 ----- 1 pc
M8x65 ----- 1 pcs



Part 10

M8 Self-Locking Nylon Nut ----- 2 pcs



Package Contents

Part 11

Washer ----- 2 pcs

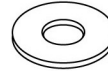

Part 12

M8 Spring Washer ----- 2 pcs



Part 13

Bottom Spacer ----- 4 pcs



Part 14

Square Nut ----- 8 pcs

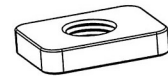

Part 15

M5x10 Socket Button Cap Screw ----- 8 pcs



Part 16

M6x12 Carriage Bolt ----- 2 pcs



Part 17

Washer
1mm ----- 4 pcs
2mm ----- 4 pcs
4mm ----- 4 pcs



Part 18

M6 Serrate Flange Nut ----- 2 pcs



Installation Guide

1. Parts Assembly - Installation of Universal Base

1.1

Lift the Projector with both middle finger along the depth of the Projector to search for the Central Gravity (CG).

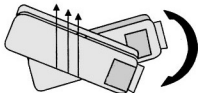

1.2

Lift the Projector with both middle finger along the depth of the Projector to search for the Central Gravity (CG).

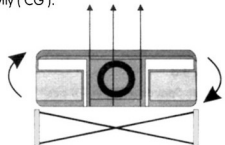

1.3

When the CG Point (Depth of Projector) and (Width of projector) intersection meet, that will be the assume CG of Projector.

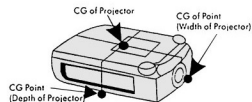

1.4

Locate the Projector CG Position and determine screw size for mounting the Projector. Place the Universal Base Plate near to the Projector CG and select the suitable Extension Bracket given in the package.

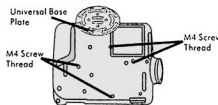

1.5

Select the suitable Extension Bracket from the Package. There are 4 sizes available as shown.

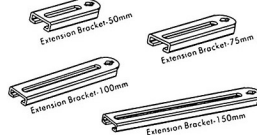

1.6

Select the suitable Extension Bracket and place it on the Projector near the CG position follow by the Universal Base Plate. Make sure the Extension Bracket is able to assemble to the Universal Base Plate.

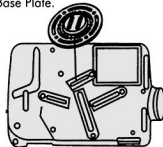

Installation Guide

1.7

Assemble the selected Extension Bracket with the following items: Bottom Spacer, Spacer (if needed) & Square Nut.
*For Extension Bracket more than 50mm (1.97") (Square Nut X 2)

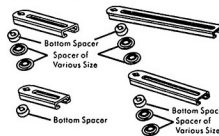

1.8

Assemble the respective Extension Bracket to the Projector as shown in the picture. Using respective Truss Head Screw from the given package to tighten lightly.

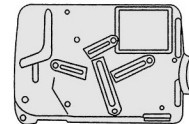

1.9a

Assemble the Universal Base Plate with the required items as shown in the picture.

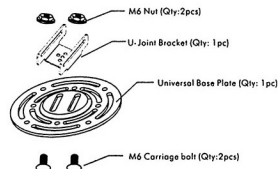

1.9b

Full assembled of the Universal Base Plate as shown in the picture.
*Do not tighten the M6 Nut until the CG is finalized.

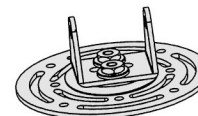

1.10

Align the assembled Universal Base Plate with all the Extension Bracket as shown in the picture. Using M5 Button Socket Cap Screws to hand tighten it.

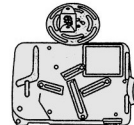

1.11

Attach the Assemble Parts as in step 1.6 to the Universal Base Plate as shown. Lift up the Projector to check the CG of the assembly before force tightening the M5 Button Socket Cap Screws and the M6 Nut. The assembly is then completed.



Installation Guide

1.12

For easy and quick installation
the universal base has been pre-installed.

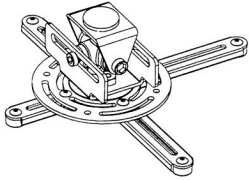

2. Installation of Universal Ceiling Mounting Kit

2.1

Install the Ceiling plate to the ceiling by M10 bolt
(not included) into the ceiling.
Refer to diagram.

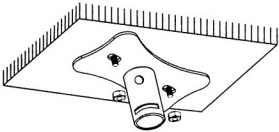

2.2

Install Shaft
Connect the shaft with the Bottom Column,
insert the Locking Hook into the cutting slot.
Tighten them with M8x50 Socket Cap Screw
and M8 Self-Locking Nylon Nut.
Refer to drawing.



2.3

Installation completed.

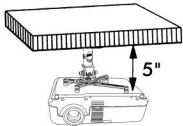

*Please consult our authorized service person when you meet any trouble in installation. We are not liable for any damage or injury caused by mishandling or improper operation.