

Operating Instructions

Thank you very much for choosing SLIK Carbon Fiber tripod. SLIK Corporation has designed your tripod to be a sturdy, rugged, dependable product that will provide you with many years of satisfactory use.

Please take a few moments to read this operating instruction carefully before use so that you can take full advantage of your Tripod's many fine features.

Retain this operating instruction in case you might want to refer back to it.

⚠ Caution

This caution icon refers to information pertaining to important safety procedures in preventing injuries, or damages which may occur as a result of mishandling this product.

🚫 Prohibition

This prohibited icon refers to information pertaining to prohibited contents. Please refer to instructions closely to avoid accidents.

Specification

PRO 624CF
 Folded length 355mm (14")
 Max. operating height 1,135mm (44 2/3")
 Max. center column ext. 210mm (8 1/4")
 Weight 822g (1lbs 13oz)

PRO 634CF
 Folded length 457mm (18")
 Max. operating height 1,603mm (63 1/8")
 Max. center column ext. 300mm (11 3/4")
 Weight 930g (2lbs 1oz)

M265

Components

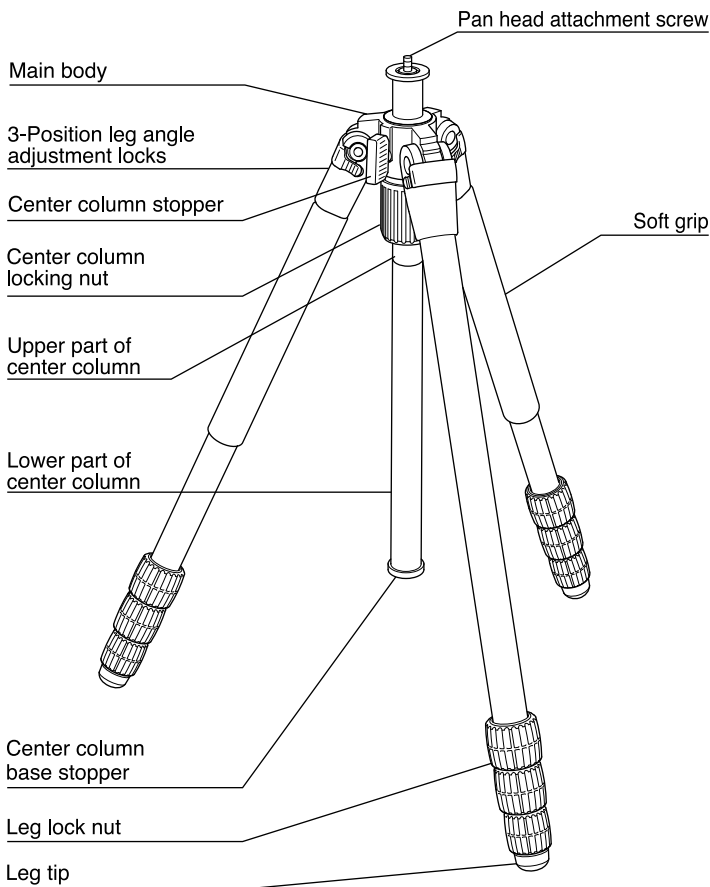

PRO 634CF

⚠ Caution

Soft Grip is consumption and cannot be used permanently. Please replace it whenever ragged.

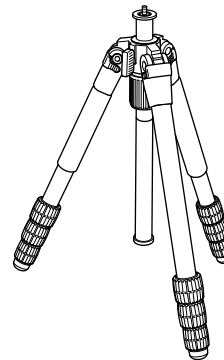

PRO 624CF

Pan head mounting post

🚫 Prohibition

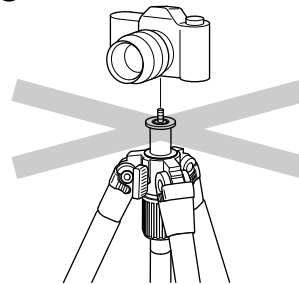

Do not attach camera directly to the attachment screw of the Center column.

This may damage both camera and tripod.

Equipment that can be loaded on this tripod

🚫 Prohibition

This product has been designed to handle equipment weighing under 3 kgs (6 lbs 10 oz). Do not overload.

Some equipments weighing under 3 kgs (6 lbs 10 oz), such as long lenses, may not balance well due to its weight distribution. In such case, please use a larger tripod.

Carrying the tripod

🚫 Prohibition

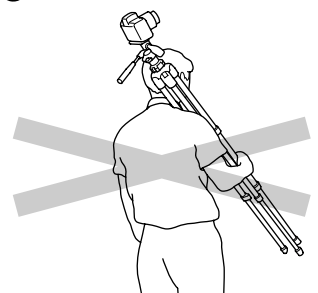

Carrying a tripod with a camera left on can result in unexpected accidents. We therefore, recommend you to remove your camera while carrying the tripod.

In case of the shock given to tripod by force

⚠ Caution

When the shock has been given to the tripods &/or legs such as falling down please check well whether there are cracks, flaws, etc. on the pipes, or not. When you find any cracks, flaws, etc. on the pipes, please stop to use it and ask to repair. It may be wounded when some of fibers came out from the pipes. In that case, please do not touch it.

Clamp head

🚫 Prohibition

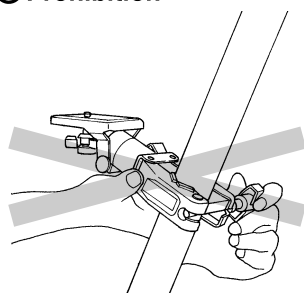

Do not use an optional Clamp head for a carbon fiber tripod. The pipe may be damaged.

Setting up

⚠ Caution

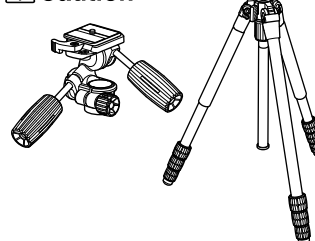

To prevent accidental equipment fall or tripod tipping over, making sure all levers, knobs and handles on the tripod are securely tightened. And all of the three legs are opened all the way.

Head setting

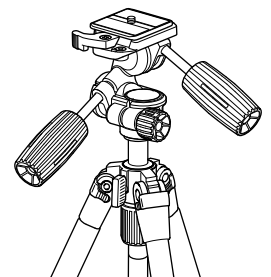

Set the new head or accessory on the Pan head attachment screw. And turn the head clockwise until it comes to stop. Tighten the Panning lock knob and turn clockwise slightly.

Extending the Tripod legs

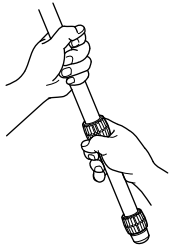

When you extend the legs, please proceed from the upper section. When you fold the legs, please proceed from the lower section. It will be steady to grip the upper part of pipe just above the lock nut.

⊘ Prohibition

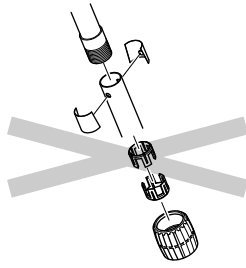

Do not remove the nut and take out pieces. If it has been removed, insert the pieces as per the above specification.

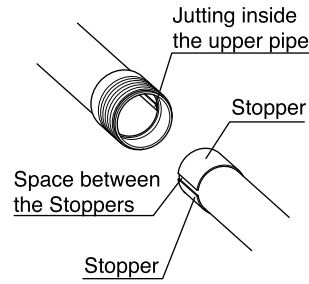

Match the space between the Stoppers and jutting inside the upper pipe when the pipe is connecting.

Three position adjustable legs

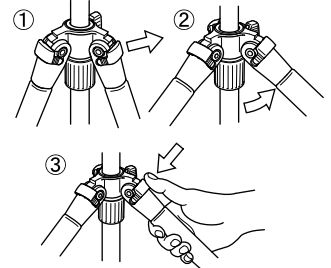

To change the angle of each leg, close the Leg slightly, and then pull the Leg angle adjustment lock out. There is a choice of two other angle positions. After choosing the desired leg angle, securely push in the Adjustment lock.

Operating the Center column

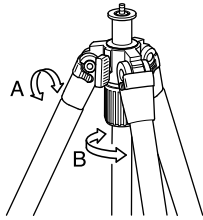

Possible to lock with two ways.
A - by Screw-type Center column stopper.
B - by Twist-type Center Column locking nut. Screw-type Center column stopper will be steady while sideslipping. Twist-type Center column locking Nut will be no sideslipping, but not perform well sometimes.

Inverting the Center column

⚠ Caution

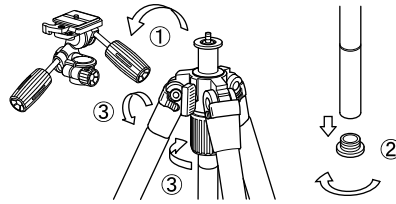

- ① Remove the Pan head when inverting or replacing the Center column.
- ② Remove the Center column base stopper turning to the direction of arrow.
- ③ Loosen the Center column stopper and the Center column locking nut, and then pull out the Center column.

⚠ Caution

Center column base stopper must be attached.

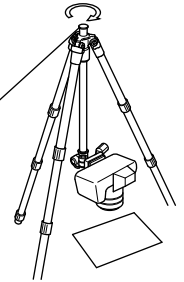

Insert the Center column from the lower side of Main body, and tighten the Center column locking nut and the Center column stopper. Make sure to re-attach the Center column base stopper in order to prevent the Center column from falling out accidentally.

How to get low position shots

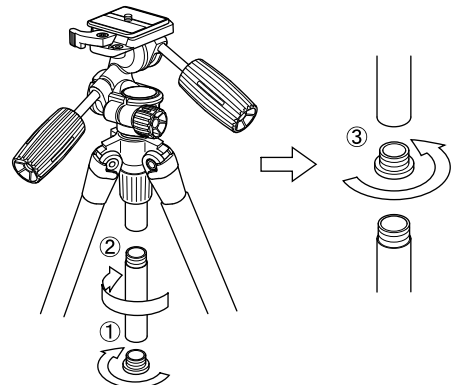
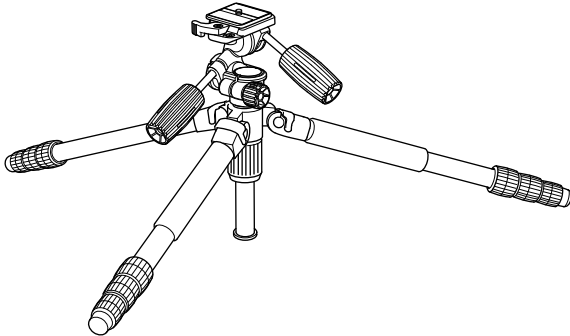

Remove the Center column base stopper, and then remove the Lower part of Center column. Put the Center column base stopper on the Upper part of Center column.

Care of the Tripod

- DO NOT apply any grease or oil to this product.
- Clean with a mild detergent and a soft cloth only.
- DO NOT use close to flame. Avoid extreme heat.



Slik corporation reserves the right to make changes in design and/or improvements on the products without any obligation and advanced notice.

SLIK CORPORATION

853 Kayama, Hidaka City, Saitama 350-1231, Japan Phone 81-42-989-2141, Fax. 81-42-985-0210 ©2010

Printed in Thailand.