

Nikon

DIGITAL CAMERA

COOLPIX L810

User's Manual

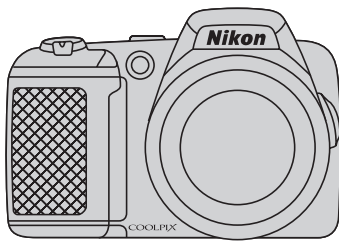

En

Trademark Information

- Microsoft, Windows and Windows Vista are either registered trademarks or trademarks of Microsoft Corporation in the United States and/or other countries.
- Macintosh, Mac OS, and QuickTime are trademarks of Apple Inc., registered in the U.S. and other countries.
- Adobe and Acrobat are registered trademarks of Adobe Systems Inc.
- SDXC, SDHC and SD Logos are trademarks of SD-3C, LLC.
- PictBridge is a trademark.
- HDMI, **HDMI** logo and High-Definition Multimedia Interface are trademarks or registered trademarks of HDMI Licensing LLC.
- All other trade names mentioned in this manual or the other documentation provided with your Nikon product are trademarks or registered trademarks of their respective holders.

AVC Patent Portfolio License

This product is licensed under the AVC Patent Portfolio License for the personal and noncommercial use of a consumer to (i) encode video in compliance with the AVC standard ("AVC video") and/or (ii) decode AVC video that was encoded by a consumer engaged in a personal and non-commercial activity and/or was obtained from a video provider licensed to provide AVC video.

No license is granted or shall be implied for any other use.

Additional information may be obtained from MPEG LA, L.L.C.

See <http://www.mpegla.com>.

Introduction

Parts of the Camera

The Basics of Shooting and Playback

Shooting Features

Playback Features

Recording and Playing Back Movies

General Camera Setup

Technical Notes and Index

Read This First

Thank you for purchasing the Nikon COOLPIX L810 digital camera. Before using the camera, please read the information in "For Your Safety" (📖 viii) and familiarize yourself with the information provided in this manual. After reading, please keep this manual handy and refer to it to enhance your enjoyment of your new camera.

Confirming the Package Contents

In the event that any items are missing, please contact the store where you purchased the camera.



COOLPIX L810
Digital Camera



Camera Strap

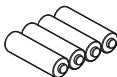

LR6/L40 (AA-size)
alkaline batteries (x4)*



Lens Cap LC-CP25
(with cord)

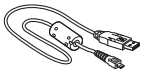

USB Cable UC-E16

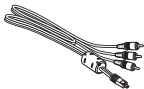

Audio Video Cable
EG-CP16



ViewNX 2 Installer CD



Reference Manual CD

- User's Manual (this manual)
- Warranty

- * The included batteries are for trial use only.
- A memory card is not included with the camera.

About This Manual

If you want to start using the camera right away, see “The Basics of Shooting and Playback” (📖 9).

To learn about the parts of the camera and information that is displayed in the monitor, see “Parts of the Camera” (📖 1).

About the Included “Reference Manual CD”

A PDF version of the COOLPIX L810 Reference Manual can be found on the included CD. Refer to it for more detailed information.

Viewing the “Reference Manual CD”





The Reference Manual can be viewed using Adobe Reader, available for free download from the Adobe website.

- 1 Start the computer and insert the “Reference Manual CD”.
- 2 Double-click the **COOLPIX L810** CD icon (Windows 7/Windows Vista: in **Computer**; Windows XP: in **My Computer**; Mac OS X: on the desktop).
- 3 Double-click the **INDEX.pdf** icon to display the language selection screen. Click a language and follow the links to view the Reference Manual.

Other Information

- Symbols and Conventions

To make it easier to find the information you need, the following symbols and conventions are used in this manual:

Icon	Description
	This icon indicates cautions and information that should be read before using the camera.
	This icon indicates notes and information that should be read before using the camera.
	These icons indicate other pages containing relevant information;  *: "Reference Section",  : "Technical Notes and Index."

* Refer to the Reference Manual CD for pages indicated with .

- SD, SDHC, and SDXC memory cards are referred to as "memory cards" in this manual.
- The setting at the time of purchase is referred to as the "default setting."
- The names of menu items displayed in the camera monitor, and the names of buttons or messages displayed on a computer monitor appear in bold.
- In this manual, images are sometimes omitted from monitor display samples so that monitor indicators can be more clearly shown.
- Illustrations and monitor content shown in this manual may differ from the actual product.

Information and Precautions

Life-Long Learning

As part of Nikon's "Life-Long Learning" commitment to ongoing product support and education, continually updated information is available online at the following sites:

- For users in the U.S.A.: <http://www.nikonusa.com/>
- For users in Europe and Africa: <http://www.europe-nikon.com/support/>
- For users in Asia, Oceania, and the Middle East: <http://www.nikon-asia.com/>

Visit these sites to keep up-to-date with the latest product information, tips, answers to frequently asked questions (FAQs), and general advice on digital imaging and photography. Additional information may be available from the Nikon representative in your area. Visit the site below for contact information:

<http://imaging.nikon.com/>

Use Only Nikon Brand Electronic Accessories

Nikon COOLPIX cameras are designed to the highest standards and include complex electronic circuitry. Only Nikon brand electronic accessories (including battery chargers, batteries, and AC adapters) certified by Nikon specifically for use with this Nikon digital camera are engineered and proven to operate within the operational and safety requirements of this electronic circuitry.

THE USE OF NON-NIKON ELECTRONIC ACCESSORIES COULD DAMAGE THE CAMERA AND MAY VOID YOUR NIKON WARRANTY.

For more information about Nikon brand accessories, contact a local authorized Nikon dealer.

Before Taking Important Pictures

Before taking pictures on important occasions (such as at weddings or before taking the camera on a trip), take a test shot to ensure that the camera is functioning normally. Nikon will not be held liable for damages or lost profits that may result from product malfunction.

About the Manuals

- No part of the manuals included with this product may be reproduced, transmitted, transcribed, stored in a retrieval system, or translated into any language in any form, by any means, without Nikon's prior written permission.
- Nikon reserves the right to change the specifications of the hardware and software described in these manuals at any time and without prior notice.
- Nikon will not be held liable for any damages resulting from the use of this product.
- While every effort was made to ensure that the information in these manuals is accurate and complete, we would appreciate it were you to bring any errors or omissions to the attention of a Nikon representative in your area (address provided separately).

Notice Concerning Prohibition of Copying or Reproduction

Note that simply being in possession of material that was digitally copied or reproduced by means of a scanner, digital camera or other device may be punishable by law.

• **Items prohibited by law from being copied or reproduced**

Do not copy or reproduce paper money, coins, securities, government bonds or local government bonds, even if such copies or reproductions are stamped "Sample." The copying or reproduction of paper money, coins, or securities which are circulated in a foreign country is prohibited. Unless the prior permission of the government was obtained, the copying or reproduction of unused postage stamps or post cards issued by the government is prohibited.

The copying or reproduction of stamps issued by the government and of certified documents stipulated by law is prohibited.

• **Cautions on certain copies and reproductions**

The government has issued cautions on copies or reproductions of securities issued by private companies (shares, bills, checks, gift certificates, etc.), commuter passes, or coupon tickets, except when a minimum of necessary copies are to be provided for business use by a company. Also, do not copy or reproduce passports issued by the government, licenses issued by public agencies and private groups, ID cards and tickets, such as passes and meal coupons.

- **Comply with copyright notices**

The copying or reproduction of copyrighted creative works such as books, music, paintings, woodcut prints, maps, drawings, movies, and photographs is governed by national and international copyright laws. Do not use this product for the purpose of making illegal copies or to infringe copyright laws.

Disposing of Data Storage Devices

Please note that deleting images or formatting data storage devices such as memory cards or built-in camera memory does not completely erase the original image data. Deleted files can sometimes be recovered from discarded storage devices using commercially available software, potentially resulting in the malicious use of personal image data. Ensuring the privacy of such data is the user's responsibility.

Before discarding a data storage device or transferring ownership to another person, erase all data using commercial deletion software, or format the device and then completely refill it with images containing no private information (for example, pictures of empty sky). Be sure to also replace any pictures selected for the **Select an image** option in the **Welcome screen** setting (📖 88). Care should be taken to avoid injury or damage to property when physically destroying data storage devices.

For Your Safety

To prevent damage to your Nikon product or injury to yourself or to others, read the following safety precautions in their entirety before using this equipment. Keep these safety instructions where all those who use the product will read them.



This icon marks warnings, information that should be read before using this Nikon product, to prevent possible injury.

WARNINGS

Turn off in the event of malfunction

Should you notice smoke or an unusual smell coming from the camera or AC adapter, unplug the AC adapter and remove the batteries immediately, taking care to avoid burns. Continued operation could result in injury. After removing or disconnecting the power source, take the equipment to a Nikon-authorized service representative for inspection.

Do not disassemble

Touching the internal parts of the camera or AC adapter could result in injury. Repairs should be performed only by qualified technicians. Should

the camera or AC adapter break open as the result of a fall or other accident, take the product to a Nikon-authorized service representative for inspection, after unplugging the product and/or removing the batteries.

Do not use the camera or AC adapter in the presence of flammable gas

Do not use electronic equipment in the presence of flammable gas, as this could result in explosion or fire.

Handle the camera strap with care

Never place the strap around the neck of an infant or child.

 **Keep out of reach of children**

Particular care should be taken to prevent infants from putting the battery or other small parts into their mouths.

 **Do not remain in contact with the camera, battery charger, or AC adapter for extended periods while the devices are on or in use**

Parts of the devices become hot. Leaving the devices in direct contact with the skin for extended periods may result in low-temperature burns.

 **Observe caution when handling batteries**

Batteries may leak or explode if improperly handled. Observe the following precautions when handling batteries for use in this product:

- Before replacing the batteries, turn the product off. If you are using an AC adapter, be sure it is unplugged.
- Use only the batteries approved for use in this product (📖 11). Do not

combine old and new batteries or batteries of different makes or types.

- When charging Nikon EN-MH2 rechargeable Ni-MH batteries, use only the specified charger and charge the batteries four at a time. When replacing the batteries with EN-MH2-B2 batteries (available separately), purchase two sets (total of four batteries).
- The EN-MH2 rechargeable batteries are for use with Nikon digital cameras only, and are compatible with COOLPIX L810.
- Insert batteries in the correct orientation.
- Do not short or disassemble batteries or attempt to remove or break battery insulation or casing.
- Do not expose batteries to flame or to excessive heat.
- Do not immerse in or expose to water.
- Do not transport or store with metal objects such as necklaces or hairpins.

- Batteries are prone to leakage when fully discharged. To avoid damage to the product, be sure to remove the batteries when no charge remains.
- Discontinue use immediately should you notice any change in the batteries, such as discoloration or deformation.
- If liquid from damaged batteries comes in contact with clothing or skin, rinse immediately with plenty of water.

 Observe the following precautions when handling the Battery Chargers (available separately)

- Keep dry. Failure to observe this precaution could result in fire or electric shock.
- Dust on or near the metal parts of the plug should be removed with a dry cloth. Continued use could result in fire.
- Do not handle the power cable or go near the battery charger during lightning storms. Failure to observe this precaution could result in electric shock.
- Do not damage, modify, forcibly tug or bend the power cable, place it under heavy objects, or expose it to heat or flame. Should the insulation be damaged and the wires become exposed, take it to a Nikon-authorized service representative for inspection. Failure to observe these precautions could result in fire or electric shock.
- Do not handle the plug or battery charger with wet hands. Failure to observe this precaution could result in electric shock.
- Do not use with travel converters or adapters designed to convert from one voltage to another or with DC-to-AC inverters. Failure to observe this precaution could damage the product or result in overheating or fire.

 **Use appropriate cables**

When connecting cables to the input and output jacks, use only the cables provided or sold by Nikon for the purpose, to maintain compliance with product regulations.

 **Handle moving parts with care**

Be careful that your fingers or other objects are not pinched by the lens cover or other moving parts.

 **CD-ROMs**

The CD-ROMs included with this device should not be played back on audio CD equipment. Playing CD-ROMs on an audio CD player could cause hearing loss or damage the equipment.

 **Observe caution when using the flash**

Using the flash close to your subject's eyes could cause temporary visual impairment. Particular care should be observed if photographing infants, when the flash should be no less than 1 m (3 ft 4 in.) from the subject.

 **Do not operate the flash with the flash window touching a person or object**

Failure to observe this precaution could result in burns or fire.

 **Avoid contact with liquid crystal**

Should the monitor break, care should be taken to avoid injury caused by broken glass and to prevent liquid crystal from the monitor touching the skin or entering the eyes or mouth.

 **Turn the power off when using inside an airplane or the hospital**

Turn the power off while inside the airplane during take off or landing. Follow the instructions of the hospital when using while in a hospital. The electromagnetic waves given out by this camera may disrupt the electronic systems of the airplane or the instruments of the hospital.

 **3D Images**

Do not continuously view 3D images recorded with this device for extended periods, whether on a television, monitor, or other display.

In the case of children whose visual systems are still maturing, consult a pediatrician or ophthalmologist prior to use and follow their instructions.

Prolonged viewing of 3D images may cause eye strain, nausea, or discomfort.

Cease use should any of these symptoms occur and consult a physician if necessary.

Notices

Notice for Customers in the U.S.A.

Federal Communications Commission (FCC) Radio Frequency Interference Statement

This equipment has been tested and found to comply with the limits for a Class B digital device, pursuant to Part 15 of the FCC rules. These limits are designed to provide reasonable protection against harmful interference in a residential installation. This equipment generates, uses, and can radiate radio frequency energy and, if not installed and used in accordance with the instructions, may cause harmful interference to radio communications. However, there is no guarantee that interference will not occur in a particular installation. If this equipment does cause harmful interference to radio or television reception, which can be determined by turning the equipment off and on, the user is encouraged to try to correct the interference by one or more of the following measures:

- Reorient or relocate the receiving antenna.
- Increase the separation between the equipment and receiver.
- Connect the equipment into an outlet on a circuit different from that to which the receiver is connected.
- Consult the dealer or an experienced radio/television technician for help.



Nikon

COOLPIX L810

CAUTIONS

Modifications

The FCC requires the user to be notified that any changes or modifications made to this device that are not expressly approved by Nikon Corporation may void the user's authority to operate the equipment.

Interface Cables

Use the interface cables sold or provided by Nikon for your equipment. Using other interface cables may exceed the limits of Class B Part 15 of the FCC rules.

Notice for customers in the State of California

WARNING

Handling the cord on this product will expose you to lead, a chemical known to the State of California to cause birth defects or other reproductive harm.

Wash hands after handling.

Nikon Inc.,
1300 Walt Whitman Road Melville,
New York 11747-3064 USA
Tel: 631-547-4200

Notice for customers in Canada

CAUTION

This Class B digital apparatus complies with Canadian ICES-003.

ATTENTION

Cet appareil numérique de la classe B est conforme à la norme NMB-003 du Canada.

Symbol for Separate Collection in European Countries

This symbol indicates that this product is to be collected separately.

The following apply only to users in European countries:

- This product is designated for separate collection at an appropriate collection point. Do not dispose of as household waste.
- For more information, contact the retailer or the local authorities in charge of waste management.



This symbol on the battery indicates that the battery is to be collected separately.

The following apply only to users in European countries:

- All batteries, whether marked with this symbol or not, are designated for separate collection at an appropriate collection point. Do not dispose of as household waste.
- For more information, contact the retailer or the local authorities in charge of waste management.



















































Table of Contents

Introduction	ii
Read This First	ii
Confirming the Package Contents	ii
About This Manual	iii
Information and Precautions	v
For Your Safety	viii
WARNINGS	viii
Notices	xiii
Parts of the Camera	1
The Camera Body	2
Attaching the Camera Strap and Lens Cap ...	4
Raising and Lowering the Flash	5
The Monitor	6
Shooting Mode	6
Playback Mode	8
The Basics of Shooting and Playback ...	9
Preparation 1 Insert the Batteries	10
Applicable Batteries	11
Preparation 2 Insert a Memory Card	13
Internal Memory and Memory Cards	14
Approved Memory Cards	15
Preparation 3 Set the Display Language, Date, and Time	16
Step 1 Turn the Camera On and Select Shooting Mode	20
Turning the Camera On and Off	22
Step 2 Frame a Picture	23
Using the Zoom	24

Step 3 Focus and Shoot	26
The Shutter-release Button	27
Step 4 Play Back Images	29
Step 5 Delete Images	31

Shooting Features	33
📷 (Easy Auto) Mode	34
Changing 📷 (Easy Auto) Mode Settings ...	34
Scene Mode (Shooting Suited to Scenes) ...	35
Changing Scene Mode Settings	36
Characteristics of Each Scene	36
Smart Portrait Mode (Capturing Smiling Faces)	44
Changing Smart Portrait Mode Settings ...	45
Options Available in the Smart Portrait Menu	46
Using Skin Softening	47
📷 (Auto) Mode	48
Changing 📷 (Auto) Mode Settings	48
Options Available in the Auto Shooting Menu	49
Features That Can Be Set Using the Multi Selector	50
Available Features	50
Using the Flash (Flash Modes)	51
Using the Self-timer	55
Using Macro Mode	57
Adjusting Brightness (Exposure Compensation)	59
Default Settings	60

Changing the Image Size (Image Mode)....	62		
Image Mode Settings (Image Size and Quality)	62		
Features That Cannot Be Used			
Simultaneously	64		
Focusing	65		
Using Face Detection	65		
Focus Lock	66		
<hr/>			
Playback Features	67		
Playback Zoom	68		
Thumbnail Display, Calendar Display	69		
Features Available in Playback Mode (Playback Menu).....	70		
Connecting the Camera to a TV, Computer, or Printer	71		
Using ViewNX 2	73		
Installing ViewNX 2	73		
Transferring Images to the Computer	76		
Viewing Images	78		
<hr/>			
Recording and Playing Back Movies	79		
Recording Movies	80		
Changing Movie Recording Settings (the Movie Menu).....	83		
Playing Back Movies	84		
<hr/>			
General Camera Setup	87		
The Setup Menu	88		
		Refer to the Reference Manual CD for pages indicated with  .	
Reference Section	 1		
Using Panorama Assist.....	 2		
Taking 3D Pictures	 5		
Editing Still Images.....	 8		
Editing Features.....	 8		
 D-Lighting: Enhancing Brightness and Contrast	 10		
 Skin Softening: Softening Skin Tones...	 11		
 Small Picture: Reducing the Size of an Image.....	 12		
 Crop: Creating a Cropped Copy ...	 13		
Editing Movies	 15		
Connecting the Camera to a TV (Viewing Images on a TV)	 17		
Connecting the Camera to a Printer (Direct Print).....	 19		
Connecting the Camera to a Printer ...	 20		
Printing Individual Images	 22		
Printing Multiple Images	 24		
The Smart Portrait Menu	 27		
Skin Softening.....	 27		
Smile Timer.....	 28		
Blink Proof	 28		

The Shooting Menu	
(for  (Auto) Mode)	 29
White Balance (Adjusting Hue)	 29
Continuous Shooting	 32
ISO Sensitivity	 33
Color Options	 34
The Playback Menu	 35
 Print Order (Creating a DPOF Print Order).....	 35
 Slide Show	 38
 Protect.....	 39
 Rotate Image	 41
 Copy (Copy Between Internal Memory and Memory Card)	 42
The Movie Menu	 44
Movie Options.....	 44
Autofocus Mode	 45
Wind Noise Reduction	 45
The Setup Menu	 46
Welcome Screen.....	 46
Time Zone and Date	 47
Monitor Settings	 51
Print Date (Imprinting Date and Time)...	 53
Vibration Reduction.....	 54
Motion Detection.....	 55
AF Assist.....	 56
Sound Settings	 57
Auto Off.....	 58
Format Memory/Format Card.....	 59
Language	 60
TV Settings.....	 61
Blink Warning.....	 62
Eye-Fi Upload.....	 64
Reset All	 65
Battery Type	 68
Firmware Version.....	 68
File and Folder Names.....	 69
Optional Accessories	 70
Error Messages.....	 71
Technical Notes and Index	 1
Caring for the Product	 2
The Camera.....	 2
Batteries.....	 4
Memory Cards	 6
Cleaning and Storage	 7
Cleaning	 7
Storage.....	 7
Troubleshooting	 8
Specifications	 16
Supported Standards.....	 20
Index	 21



Parts of the Camera

This chapter describes the parts of the camera and explains information that is displayed in the monitor.

The Camera Body	2
Attaching the Camera Strap and Lens Cap	4
Raising and Lowering the Flash	5
The Monitor	6
Shooting Mode	6
Playback Mode	8

➔ If you want to start using the camera right away, see “The Basics of Shooting and Playback” (📖 9).

The Camera Body

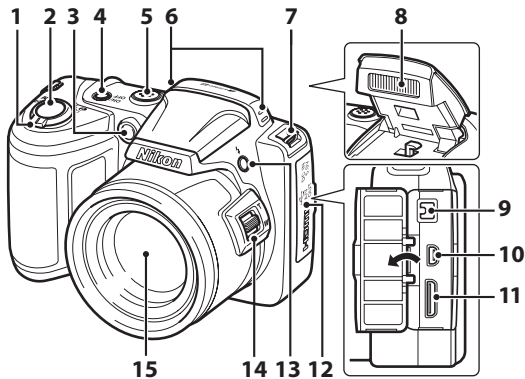

1	Zoom control.....	24
	W : wide.....	24
	T : tele.....	24
	: thumbnail playback.....	69
	: playback zoom.....	68
	: help.....	35
2	Shutter-release button.....	26
3	Self-timer lamp.....	55
	AF-assist illuminator.....	88
4	Power switch/power-on lamp.....	20
5	Speaker.....	84
6	Built-in microphone (stereo).....	80

7	Eyelet for camera strap.....	4
8	Flash.....	5, 51
9	DC input connector (for AC adapter available separately from Nikon).....	12, 70
10	USB connector and audio/video output...71	
11	HDMI mini connector (Type C).....	71
12	Connector cover.....	71
13	(flash pop-up) button.....	5, 51
14	Side zoom control.....	24
15	Lens	

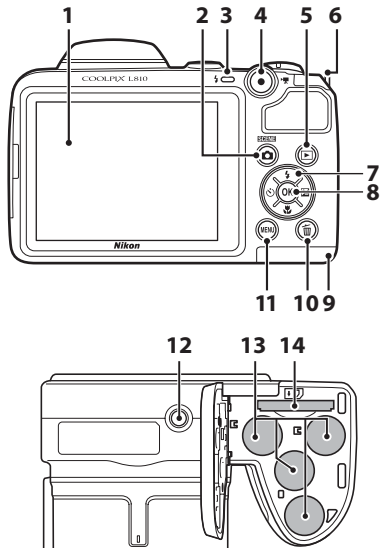

1 Monitor 6

2 (shooting mode) button
..... 34, 35, 44, 48

3 Flash lamp 52

4 (movie-record) button 80

5 (playback) button 29

6 Eyelet for camera strap 4

7 Multi selector

8 (apply selection) button

9 Battery-chamber/
memory card slot cover 10, 13

10 (delete) button 31

11 **MENU** button 46, 49, 70, 83, 88

12 Tripod socket 18

13 Battery chamber 10

14 Memory card slot 13

Attaching the Camera Strap and Lens Cap

Attach the lens cap to the camera strap, and then attach the strap to the camera.

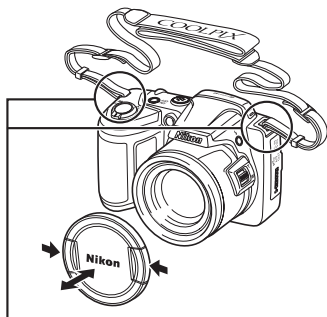
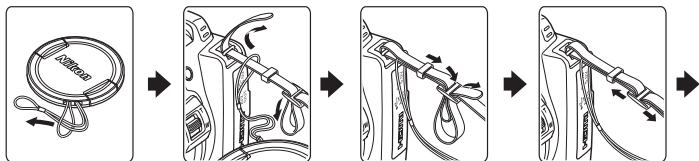



Attach them at two places.

✓ Lens Cap

- Remove the lens cap before you take a picture.
- At times when you will not be taking pictures such as when the power is off or while you are carrying the camera, attach the lens cap to the camera to protect the lens.

Raising and Lowering the Flash

Press the  (flash pop-up) button to raise the flash.

- Using the Flash (Flash Modes) →  51
- Push the flash down gently to lower the flash until it clicks into place when not in use.

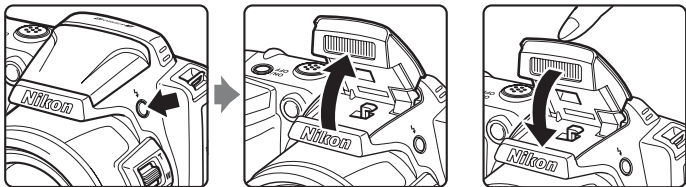



The Monitor

- The information that is displayed in the monitor during shooting and playback changes depending on the camera's settings and state of use. By default, information is displayed when the camera is turned on and when you operate the camera, and turns off after a few seconds (**Monitor settings** (📖 88) > **Photo info** > **Auto info**).

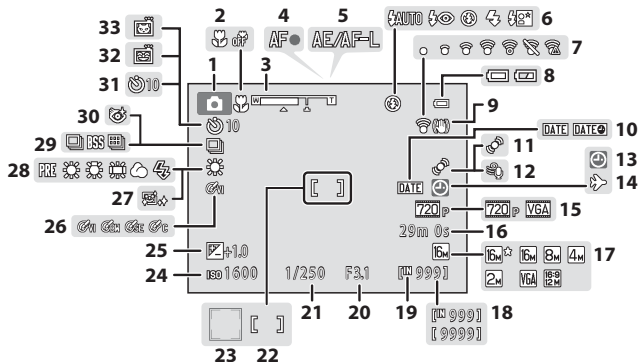
Shooting Mode



1	Shooting mode.....	34, 35, 44, 48
2	Macro mode	57
3	Zoom indicator	24, 57
4	Focus indicator.....	26
5	AE/AF-L indicator.....	 83
6	Flash mode.....	51
7	Eye-Fi indicator	89
8	Battery level indicator	21
9	Vibration reduction icon.....	88
10	Print date	88
11	Motion detection icon	88
12	Wind noise reduction	83
13	“Date not set” indicator.....	19, 88,  71
14	Travel destination indicator	88
15	Movie options.....	83
16	Movie length.....	82
17	Image mode	62
18	Number of exposures remaining (still images).....	21
19	Internal memory indicator	21
20	Aperture value	27
21	Shutter speed.....	27
22	Focus area.....	23, 26
23	Focus area (face detection, pet detection)	23, 26
24	ISO sensitivity.....	49
25	Exposure compensation value	59
26	Color options.....	49
27	Skin softening.....	46
28	White balance mode	49
29	Continuous shooting mode	49
30	Blink proof icon	46
31	Self-timer indicator	55
32	Smile timer	46
33	Pet portrait auto release	42

Playback Mode

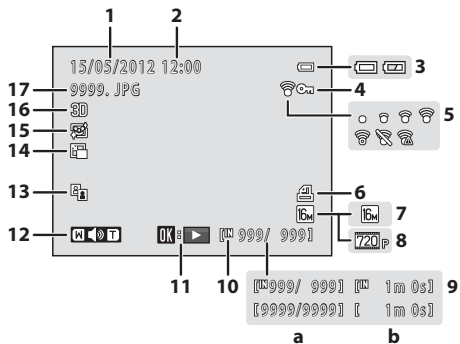

1	Date of recording	16	10	Internal memory indicator	29
2	Time of recording	16	11	Movie play indicator	84
3	Battery level indicator	21	12	Volume indicator	85
4	Protect icon	70	13	D-Lighting icon	70
5	Eye-Fi indicator	89	14	Small picture icon	70
6	Print order icon	70	15	Skin softening icon	70
7	Image mode	62	16	3D image indicator	43
8	Movie options	83	17	File number and type	69
9	(a) Current image number/ total number of images	29			
	(b) Movie length	84			



The Basics of Shooting and Playback

Preparation

Preparation 1 Insert the Batteries	10
Preparation 2 Insert a Memory Card	13
Preparation 3 Set the Display Language, Date, and Time.....	16



Shooting

Step 1 Turn the Camera On and Select Shooting Mode.....	20
Step 2 Frame a Picture	23
Step 3 Focus and Shoot	26



Playback

Step 4 Play Back Images	29
Step 5 Delete Images.....	31

Preparation 1 Insert the Batteries

1 Open the battery-chamber/memory card slot cover.

- Before opening the battery-chamber/memory card slot cover, hold the camera upside down to prevent the batteries from falling out.

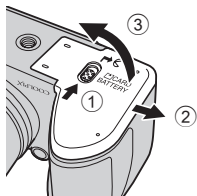

2 Insert the batteries.

- Confirm that the positive (+) and negative (-) terminals are oriented correctly as described on the label at the entrance of the battery chamber, and insert the batteries.

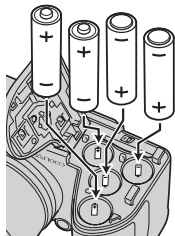

3 Close the battery-chamber/memory card slot cover.

- Slide the cover while securely holding down the area marked ②.

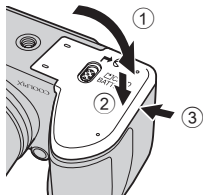

Applicable Batteries

- Four LR6/L40 (AA-size) alkaline batteries (batteries included)
- Four FR6/L91 (AA-size) lithium batteries
- Four EN-MH2 rechargeable Ni-MH (nickel metal hydride) batteries
- * EN-MH1 rechargeable Ni-MH batteries cannot be used.

✓ Removing the Batteries

- Turn the camera off and be sure that the power-on lamp and the monitor have turned off before opening the battery-chamber/memory card slot cover.
- The camera, batteries, or memory card may be hot immediately after using the camera. Observe caution when removing the batteries or memory card.

✓ Notes About the Batteries

- Be sure to read and follow the warnings for the battery on page ix and in "Batteries" (🔋:4) before use.
- Do not combine old and new batteries or batteries of different makes or types.
- Batteries with the following defects cannot be used:

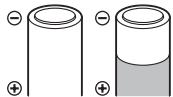

Batteries with peeling



Batteries with insulation that does not cover the area around the negative terminal

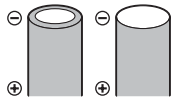

Batteries with a flat negative terminal

✓ Battery Type

By setting **Battery type** in the setup menu (📖 88) to match the type of batteries inserted in the camera, the batteries can perform more efficiently.

The default setting is the type of battery included with purchase. When any other type of battery is used, turn the camera on and change the setting.

Notes About EN-MH2 Rechargeable Batteries

When using EN-MH2 batteries with the COOLPIX L810, charge the batteries four at a time using Battery Charger MH-73 ( 89,  70).

Alkaline Batteries

Performance of alkaline batteries may vary greatly depending on the manufacturer. Choose a reliable brand.

Notes About an AC Power Source

- You can use the AC Adapter EH-67 (available separately;  70) to power the camera from an electrical outlet.
- Do not, under any circumstances, use another make or model of AC adapter other than the EH-67. Failure to observe this precaution could result in overheating or in damage to the camera.

Preparation 2 Insert a Memory Card

1 Turn off the camera and open the battery-chamber/memory card slot cover.

- When the camera turns off, the power-on lamp and the display turn off.
- Before opening the battery-chamber/memory card slot cover, hold the camera upside down to prevent the batteries from falling out.

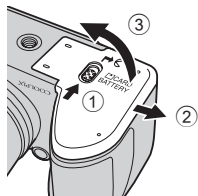

2 Insert a memory card.

- Slide the memory card in until it clicks into place.

Inserting a Memory Card

Inserting a memory card upside down or backwards could damage the camera and the memory card. Be sure to check that the memory card is in the correct orientation.

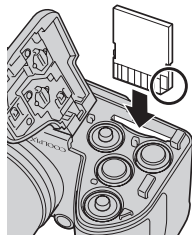

3 Close the battery-chamber/memory card slot cover.

- Slide the cover while securely holding down the area marked ②.

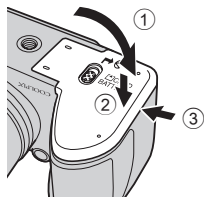

✓ Formatting a Memory Card

- The first time you insert a memory card that has been used in another device into this camera, be sure to format it with this camera.
- **All data stored on a memory card is permanently deleted when the card is formatted.** Copy any data on the card that you wish to keep to a computer before formatting.
- To format a memory card, insert the card into the camera, press the **MENU** button, and select **Format card** (🔑 59) in the setup menu (📖 88).

✓ Notes About Memory Cards

See “Memory Cards” (🔑 6) and the documentation included with your memory card for more information.

Removing the Memory Card

- Turn the camera off and be sure that the power-on lamp and the monitor have turned off before opening the battery-chamber/memory card slot cover.
- Gently push the memory card into the camera (①) to partially eject the card, and then remove the card (②). Do not pull it at an angle.
- The camera, battery, and memory card may be hot immediately after using the camera. Observe caution when removing the battery or memory card.

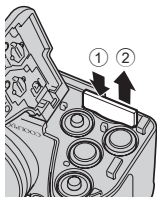

Internal Memory and Memory Cards

Camera data, including images and movies, can be saved in either the camera’s internal memory (approximately 50 MB) or on a memory card. Remove the memory card to use the internal memory for image saving and playback.

Approved Memory Cards

The following Secure Digital (SD) memory cards have been tested and approved for use in this camera.

- Memory cards with an SD Speed Class rating of 6 or faster are recommended for recording movies. When using a memory card with a lower Speed Class rating, movie recording may stop unexpectedly.

	SD memory card	SDHC memory card ²	SDXC memory card ³
SanDisk	2 GB ¹	4 GB, 8 GB, 16 GB, 32 GB	64 GB
TOSHIBA	2 GB ¹	4 GB, 8 GB, 16 GB, 32 GB	64 GB
Panasonic	2 GB ¹	4 GB, 8 GB, 12 GB, 16 GB, 32 GB	48 GB, 64 GB
Lexar	–	4 GB, 8 GB, 16 GB, 32 GB	64 GB, 128 GB

¹ If the memory card will be used with a card reader or similar device, make sure that the device supports 2 GB cards.

² SDHC compliant.

If the memory card will be used with a card reader or similar device, make sure that the device supports SDHC.

³ SDXC compliant.

If the memory card will be used with a card reader or similar device, make sure that the device supports SDXC.

- Contact the manufacturer for details on the above cards. We cannot guarantee camera performance when using memory cards made by other manufacturers.



Preparation 3 Set the Display Language, Date, and Time

When the camera is turned on for the first time, the language-selection screen and the date and time setting screen for the camera clock are displayed.

1 Press the power switch to turn on the camera.

- When the camera is turned on, the power-on lamp (green) will light and then the monitor will turn on (the power-on lamp turns off when the monitor turns on).

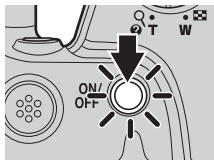

2 Press the multi selector ▲ or ▼ to select the desired language and press the **OK** button.

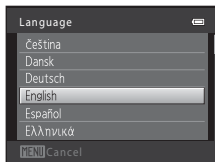

3 Press ▲ or ▼ to select **Yes** and press the **OK** button.

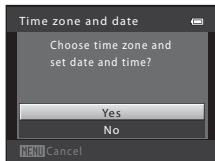

4 Press ◀ or ▶ to select your home time zone and press the **OK** button.

- Press ▲ to enable daylight saving time. When the daylight saving time function is enabled, ☀ is displayed at the top of the monitor. Press ▼ to disable the daylight saving time function.

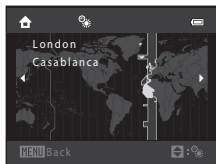

5 Press ▲ or ▼ to select the date format and press the **OK** button.

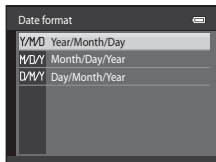

6 Press ▲, ▼, ◀, or ▶ to set the date and time, and press the **OK** button.

- Select an item: Press ▶ or ◀ (changes between **D**, **M**, **Y**, **hour**, and **minute**).
- Edit the date and time: Press ▲ or ▼.
- Confirm the setting: Select the minute setting and press the **OK** button.

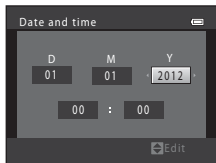

7 Press ▲ or ▼ to select **Yes** and then press the **OK** button.

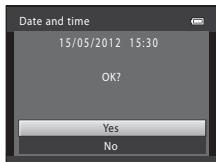

8 Make sure that the lens cap has been removed, then press the button.

- The lens extends and the shooting-mode selection screen is displayed.

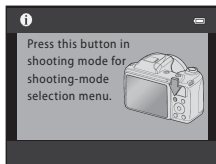

9 When **Easy auto mode** is displayed, press the button.

- The camera enters the shooting mode and you can take pictures in Easy auto mode (📖 20).
- To switch to another shooting mode, press the multi selector ▲ or ▼ before pressing the  button.

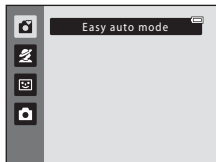

Changing the Language Setting and the Date and Time Setting

- You can change these settings using the **Language** (🔍60) and **Time zone and date** (🔍47) settings in the **Y** setup menu (📖 88).
- You can enable and disable daylight saving time by selecting the **Y** setup menu > **Time zone and date** (🔍47) > **Time zone**. When enabled, the clock moves forward one hour; when disabled, the clock moves back one hour. When the travel destination (👉) is selected, the time difference between the travel destination and the home time zone (🏠) is automatically calculated and the date and time in the selected region are saved at the time of shooting.
- If you exit without setting the date and time, ⏰ will flash when the shooting screen is displayed. Use the **Time zone and date** setting in the setup menu to set the date and time (📖 88, 🔍47).

The Clock Battery

- The camera's clock is powered by a backup battery that is separate from the camera's main battery.
- The backup battery charges when the main battery is inserted into the camera or when the camera is connected to an optional AC adapter, and can provide several days of backup power after about ten hours of charging.
- If the camera's backup battery becomes exhausted, the date and time setting screen is displayed when the camera is turned on. Set the date and time again. → Step 3 of "Preparation 3 Set the Display Language, Date, and Time" (📖 16)

Imprinting the Shooting Date in Printed Images

- Set the date and time before shooting.
- You can permanently imprint the shooting date in images as they are captured by setting **Print date** (🔍53) in the setup menu (📖 88).
- If you want the shooting date to be printed without using the **Print date** setting, print using the ViewNX 2 software (📖 73).

Step 1 Turn the Camera On and Select Shooting Mode

1 Remove the lens cap and press the power switch to turn on the camera.

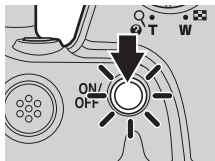

- The lens extends and the monitor turns on.
- Press the  (flash pop-up) button to raise the flash (📖 5).

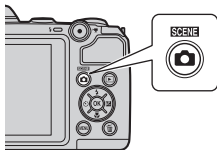

2 Press the  button.

- The shooting-mode selection menu, which allows you to select the desired shooting mode, is displayed.



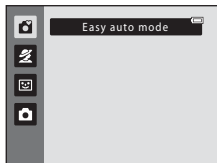

3 Press the multi selector  or  to select the desired shooting mode and press the  button.

-  (easy auto) mode is used in this example.



4 Check the battery level indicator and the number of exposures remaining.

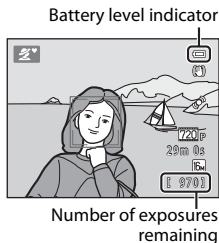

Battery Level Indicator

Display	Description
	Battery level high.
	Battery level low. Prepare to replace the batteries.
Battery exhausted.	Cannot take pictures. Replace the batteries.





Number of Exposures Remaining

The number of pictures that can be taken is displayed.

-  is displayed when no memory card is inserted in the camera, and images will be saved in the internal memory (approx. 50 MB).
- The number of exposures remaining depends on the amount of available memory in the internal memory or memory card, and also varies depending on the image quality and image size (determined by the image mode setting;  63).

Notes About the Flash

In situations where you want to use the flash, such as in dark locations or when the subject is backlit, press the  (flash pop-up) button to raise the flash ( 5, 51).

The flash does not pop-up automatically. When the flash is lowered, the flash does not fire no matter what the shooting conditions are.

Turning the Camera On and Off

- Remove the lens cap and turn the camera on.
- When the camera is turned on, the power-on lamp (green) will light and then the monitor will turn on (the power-on lamp turns off when the monitor turns on).
- To turn off the camera, press the power switch. When the camera turns off, the power-on lamp and the monitor turn off.
- You can press and hold the  (playback) button to turn on the camera and switch to playback mode. The lens will not extend.

If Turn the camera off, remove the lens cap, and turn the camera on. Is Displayed

Make sure that the lens cap has been removed, and turn the camera off and then on again.

Power Saving Function (Auto Off)

If no operations are performed for a while, the monitor will turn off, the camera will enter standby mode, and the power-on lamp will flash. If no operations are performed for approximately another three minutes, the camera will turn off automatically.

While the camera is in standby mode, the monitor turns back on if you perform any of the following operations:

→ Press the power switch, shutter-release button,  (shooting mode) button,  (playback) button, or  (movie-record) button

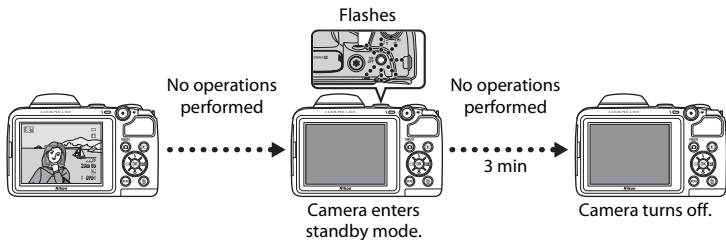

- The time that elapses before the camera enters standby mode can be changed using the **Auto off** setting in the setup menu ( 88).
- By default, the camera enters standby mode in about 30 seconds when you are using shooting mode or playback mode.
- If you are using the optional AC Adapter EH-67, the camera enters standby mode after 30 minutes.

Step 2 Frame a Picture

1 Hold the camera steady.

- Keep fingers, hair, the camera strap, and other objects away from the lens, flash, AF assist-illuminator, and microphone.

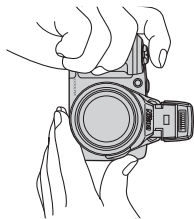
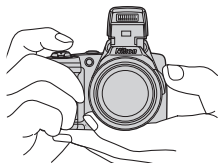

2 Frame the picture.

- When the camera determines the scene mode, the shooting mode icon will change (book 34).
- When the camera detects a human face, that face is framed by a yellow double border (focus area).
- When shooting non-human subjects or when no faces are detected, the camera focuses on the subject in the center of the frame. Position the main subject near the center of the frame.

Shooting mode icon

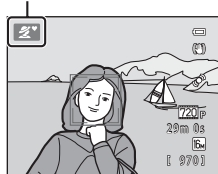

✓ Easy Auto Mode

- Depending upon shooting conditions, the camera may not select the desired scene mode. In this case, select another shooting mode (📖 34, 35, 44, and 48).
- When the digital zoom is in effect, the scene mode changes to 📷.

📎 When Using a Tripod

- We recommend using a tripod to stabilize the camera in the following situations:
 - When shooting in dimly lit conditions with the flash mode (📖 53) set to 📷 (off)
 - When zooming in on the subject
- Set **Vibration reduction** to **Off** in the setup menu (📖 88) when using a tripod.

Using the Zoom

Use the zoom control to activate optical zoom.

- To zoom in closer to the subject, rotate the zoom control to **T** (telephoto).
- To zoom out and view a larger area, rotate the zoom control to **W** (wide-angle).
When you turn the camera on, the zoom moves to the maximum wide-angle position.

- The side zoom control (📖 2) can also be turned toward **T** or **W** to operate the zoom.

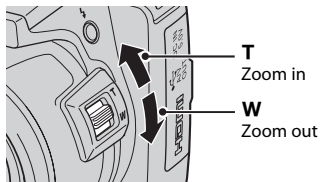
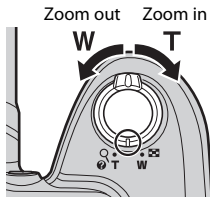

- A zoom indicator is displayed at the top of the monitor when the zoom control is operated.

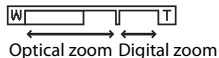

Digital Zoom

When the camera is zoomed in to the maximum optical zoom position, rotating and holding the zoom control or the side zoom control toward **T** triggers digital zoom.

Digital zoom can magnify the subject up to about 4× beyond the maximum magnification of the optical zoom.

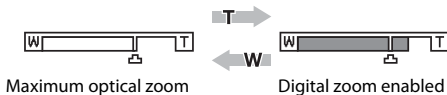

- When you are using digital zoom, the camera focuses on the subject in the center of the frame and the focus area is not displayed.

Digital Zoom and Interpolation

Unlike optical zoom, digital zoom uses a digital imaging process known as interpolation to magnify images, resulting in slight deterioration of picture quality according to the image mode (📖 62) and digital zoom magnification.

Interpolation is applied at zoom positions beyond 📷 when taking still pictures. When zoom is increased beyond the 📷 position, interpolation is initiated and the zoom indicator turns yellow to indicate that interpolation is being applied.

The position of 📷 moves to the right as image size decreases, allowing you to confirm the zoom position at which shooting without interpolation is possible at the current image mode setting.



Step 3 Focus and Shoot

1 Press the shutter-release button halfway (📖 27).

- When a face is detected:
The camera focuses on the face framed by the double border. When the subject is in focus, the double border glows green.
- When a face is not detected:
The camera focuses on the subject in the center of the frame. When the camera has focused, the focus area glows green.

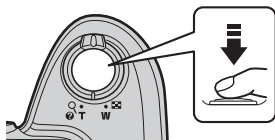



- When you are using digital zoom, the camera focuses on the subject in the center of the frame and the focus area is not displayed. When the camera has focused, the focus indicator (📖 6) glows green.
- While the shutter-release button is pressed halfway, the focus area or focus indicator may flash in red. This indicates that the camera is unable to focus. Modify the composition and press the shutter-release button halfway again.

2 Press the shutter-release button the rest of the way down (📖 27).

- The shutter is released and the image will be saved to the memory card or internal memory.



The Shutter-release Button

<p>Press halfway</p>		<p>To set focus and exposure (shutter speed and aperture value), press the shutter-release button halfway, stopping when you feel resistance. Focus and exposure remain locked while the shutter-release button is pressed halfway.</p>
<p>Press all the way</p>		<p>While pressing the shutter-release button halfway, press the shutter-release button the rest of the way down to release the shutter and take a picture. Do not use force when pressing the shutter-release button, as this may result in camera shake and blurred images. Press the button gently.</p>

Notes About Saving Data

After taking pictures or recording a movie, the number of exposures remaining or the remaining recording time flashes while images or movies are being saved. **Do not open the battery-chamber/memory card slot cover** while images or movies are being saved. Image and movie data could be lost and the camera or memory card could be damaged.

Autofocus

The camera may not focus as expected in the following situations. In some rare cases, the subject may not be in focus despite the fact that the focus area or the focus indicator glows green:



- Subject is very dark
- Objects of sharply differing brightness are included in the scene (e.g. the sun behind the subject makes that subject appear very dark)
- No contrast between the subject and surroundings (e.g. a portrait subject, wearing a white shirt, is standing in front of a white wall)
- Several objects are at different distances from the camera (e.g. the subject is inside a cage)
- Subjects with repeating patterns (window blinds, buildings with multiple rows of similarly shaped windows, etc.)
- Subject is moving rapidly

In the situations noted above, try pressing the shutter-release button halfway to refocus several times, or select auto mode and use focus lock ( 66) to take the picture by first focusing on an object that is the same distance from the camera as the desired subject.

Notes About Face Detection

See “Using Face Detection” ( 65) for more information.

AF-assist Illuminator and Flash

If the subject is dimly lit, the AF-assist illuminator ( 88) may light when the shutter-release button is pressed halfway, and the flash ( 51) may fire when the shutter-release button is pressed all the way down.

To Make Sure You Do Not Miss a Shot

If you are concerned that you might miss a shot, press the shutter-release button all the way without first pressing it halfway.





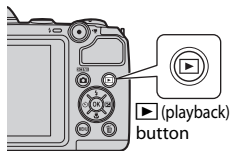

Step 4 Play Back Images

1 Press the (playback) button.

- The camera switches to playback mode and the last image saved is displayed in full-frame playback mode.



2 Use the multi selector to select an image to display.

- Display the previous image:  or 
- Display the next image:  or 
- Remove the memory card from the camera to play back images saved in the camera's internal memory.  is displayed near the current image number/total number of images display.
- To return to shooting mode, press the  button, the shutter-release button, or the  button.

Display the previous image



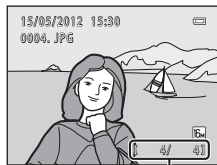

Display the next image





Current image number/
total number of images

Viewing Images

- Images may be displayed briefly at low resolution while being read from the memory card or internal memory.
- When you play back images in which the face of a person ( 65) or pet ( 42) was detected at the time of shooting, depending on the orientation of the detected face, the images are automatically rotated for playback display.



More Information

- Playback Zoom →  68
- Thumbnail Display, Calendar Display →  69
- Features Available in Playback Mode (Playback Menu) →  70

Step 5 Delete Images

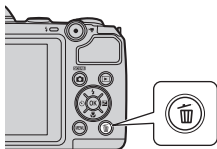

- 1 Press the  button to delete the image currently displayed in the monitor.



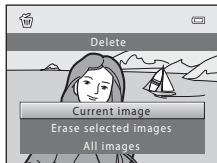

- 2 Press the multi selector  or  to select the desired deletion method and press the  button.

- **Current image:** Only the current image is deleted.
- **Erase selected images:** Multiple images can be selected and deleted ( 32).
- **All images:** All images are deleted.
- To exit without deleting, press the **MENU** button.



- 3 Press  or  to select **Yes** and press the  button.

- Deleted images cannot be recovered.
- To cancel, press  or  to select **No** and press the  button.

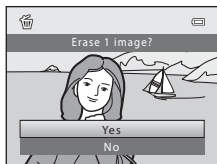

Operating the Erase Selected Images Screen

- 1 Press the multi selector ◀ or ▶ to select an image to be deleted, and then press ▲ to display ✓.
 - To undo the selection, press ▼ to remove ✓.
 - Rotate the zoom control (L 2) to T (R) to switch back to full-frame playback or W (E) to display thumbnails.



- 2 Add ✓ to all images that you want to delete and then press the OK button to confirm the selection.
 - A confirmation dialog is displayed. Follow the instructions displayed in the monitor.

✓ Notes About Deletion

- Deleted images cannot be recovered. Copy important images to a computer before deleting them from the camera.
- Protected images (L 70) cannot be deleted.

✍ Deleting the Last Image Captured While in Shooting Mode



When using shooting mode, press the  button to delete the last image that was saved.



Shooting Features



This chapter describes the camera's shooting modes and the features that are available when using each shooting mode.

You can select shooting modes and adjust settings according to the shooting conditions and the kind of images you want to capture.

 (Easy Auto) Mode.....	34
Scene Mode (Shooting Suited to Scenes)	35
Smart Portrait Mode (Capturing Smiling Faces) ...	44
 (Auto) Mode	48
Features That Can Be Set Using the Multi Selector	50
Using the Flash (Flash Modes)	51
Using the Self-timer.....	55
Using Macro Mode.....	57
Adjusting Brightness (Exposure Compensation).....	59
Changing the Image Size (Image Mode).....	62
Features That Cannot Be Used Simultaneously.....	64
Focusing	65

(Easy Auto) Mode

The camera automatically selects the optimum scene mode when you frame a picture.

Enter shooting mode →  (shooting mode) button →  (easy auto) mode →  button

Automatic Scene Selection

The camera automatically selects one of the following scenes when you point the camera at a subject:





-  Portrait (📖 36)
-  Landscape (📖 36)
-  Night portrait (📖 37)
-  Night landscape (📖 39)
-  Close-up (📖 39)
-  Backlighting (📖 40)
-  Other scenes

Changing (Easy Auto) Mode Settings







































- Depending on the scene selected by the camera, you can press the multi selector ▲ (⚡), ◀ (🕒), and ▶ (📷) to set the corresponding features. → “Features That Can Be Set Using the Multi Selector” (📖 50), “Default Settings” (📖 60)
- Features that can be set by pressing the **MENU** button → Image mode, which is the combination of image size and image quality (📖 62)

Scene Mode (Shooting Suited to Scenes)



When one of the following scenes is selected, camera settings are automatically optimized for the selected scene.

Enter shooting mode →  (shooting mode) button →  (second icon from the top*) →  → select a scene →  button

* The icon of the last scene selected is displayed.

 Portrait (default setting;  36)	 Landscape ( 36)	 Sports ( 37)	 Night portrait ( 37)
 Party/indoor ( 37)	 Beach ( 38)	 Snow ( 38)	 Sunset ( 38)
 Dusk/dawn ( 38)	 Night landscape ( 39)	 Close-up ( 39)	 Food ( 39)
 Museum ( 40)	 Fireworks show ( 40)	 Black and white copy ( 40)	 Backlighting ( 40)
 Panorama assist ( 41)	 Pet portrait ( 42)	 3D photography ( 43)	

To View a Description (Help Display) of Each Scene

Select the desired scene from the scene selection screen and rotate the zoom control ( 2) to **T** () to view a description of that scene. To return to the original screen, rotate the zoom control to **T** () again.



Changing Scene Mode Settings

- Depending on the scene, the multi selector ▲ (📶), ▼ (📶), ◀ (📶), and ▶ (📶) can be used to set the corresponding features. → “Features That Can Be Set Using the Multi Selector” (📖 50), “Default Settings” (📖 60)
- Features that can be set by pressing the **MENU** button → Image mode, which is the combination of image size and image quality (📖 62)

Characteristics of Each Scene

👤 Portrait

Use this mode for portraits.

- When the camera detects a human face, it focuses on that face (📖 65).
- You can use the skin softening option to smooth the skin tones in human faces (📖 47).
- If no faces are detected, the camera focuses on the subject in the center of the frame.
- Digital zoom cannot be used.



🏞️ Landscape

Use this mode for vivid landscapes and cityscapes.

- The focus area or focus indicator (📖 7) always glows green when the shutter-release button is pressed halfway.



📵: Use of a tripod is recommended when using scene modes indicated with 📵. Set **Vibration reduction to Off** in the setup menu (📖 88) when using a tripod to stabilize the camera during shooting.

Sports

Use this mode when shooting sporting events. The camera captures a series of still images that allow you to clearly see detailed movements in a moving subject.



- The camera focuses on the area in the center of the frame.
- Press and hold the shutter-release button all the way to capture images continuously. Up to about four images are captured continuously at a rate of about 1.2 fps (when **Image mode** is set to )
- The camera focuses even when the shutter-release button is not pressed halfway. You may hear the sound of the camera focusing.
- Focus, exposure, and hue are fixed at the values determined with the first image in each series.
- The frame rate with continuous shooting may vary depending upon the current image mode setting, the memory card used, or shooting condition.



Night portrait



Use this mode for evening and night portraits that include background scenery. The flash fires to light the portrait subject while preserving background lighting to achieve a natural balance between the main subject and background ambience.

- Raise the flash before shooting.
- When the camera detects a human face, it focuses on that face ( 65).
- You can use the skin softening option to smooth the skin tones in human faces ( 47).
- If no faces are detected, the camera focuses on the subject in the center of the frame.
- Digital zoom cannot be used.



Party/indoor

Suitable for taking pictures at parties. Captures the effects of candlelight and other indoor background lighting.

- The camera focuses on the area in the center of the frame.
- As images are easily affected by camera shake, hold the camera steadily. Set **Vibration reduction** to **Off** in the setup menu ( 88) when using a tripod to stabilize the camera during shooting.



 Beach

Captures the brightness of such subjects as beaches or sunlit expanses of water.

- The camera focuses on the area in the center of the frame.

 Snow

Captures the brightness of sunlit snow.

- The camera focuses on the area in the center of the frame.

 Sunset

Preserves the deep hues seen in sunsets and sunrises.



- The camera focuses on the area in the center of the frame.

 Dusk/dawn

Preserves the colors seen in the weak natural light before sunrise or after sunset.

- The focus area or focus indicator (📖 7) always glows green when the shutter-release button is pressed halfway.



 Use of a tripod is recommended when using scene modes indicated with . Set **Vibration reduction** to **Off** in the setup menu (📖 88) when using a tripod to stabilize the camera during shooting.

Night landscape





Slow shutter speeds are used to capture stunning night landscapes.

- The focus area or focus indicator ( 7) always glows green when the shutter-release button is pressed halfway.



Close-up





Use this mode to photograph flowers, insects, and other small objects at close range.

- Macro mode ( 57) is enabled and the camera automatically zooms to the closest position at which it can focus.
- The camera focuses on the area in the center of the frame. Use focus lock to frame the picture on an object not in the center of the frame ( 66).
- The camera focuses even when the shutter-release button is not pressed halfway. You may hear the sound of the camera focusing.



Food

Use this mode when taking pictures of food.

- Macro mode ( 57) is enabled and the camera automatically zooms to the closest position at which it can focus.
- You can adjust hue by pressing the multi selector  and . The hue setting is saved in the camera's memory even after the camera is turned off.
- The camera focuses on the area in the center of the frame. Use focus lock to frame the picture on an object not in the center of the frame ( 66).
- The camera focuses even when the shutter-release button is not pressed halfway. You may hear the sound of the camera focusing.

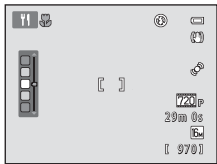

Museum

Use indoors where flash photography is prohibited (for example, in museums and art galleries) or in other settings in which you do not want to use the flash.

- The camera focuses on the area in the center of the frame.
- The camera captures a series of up to ten images while the shutter-release button is held all the way down, and the sharpest image in the series is automatically selected and saved (best shot selector).



Fireworks show



Slow shutter speeds are used to capture the light from fireworks.

- Camera focuses at infinity.
- When the shutter-release button is pressed halfway, the focus indicator ( 7) always glows green.



Black and white copy

Provides clear images of text or drawings on a whiteboard or in print.

- The camera focuses on the area in the center of the frame.
- Use together with macro mode ( 57) when shooting subjects that are close to the camera.

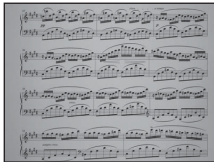



Backlighting

Use when light is coming from behind the subject, throwing features or details into shadow. The flash fires automatically to “fill in” (illuminate) shadows.









- Raise the flash before shooting.
- The camera focuses on the area in the center of the frame.



 Use of a tripod is recommended when using scene modes indicated with . Set **Vibration reduction to Off** in the setup menu ( 88) when using a tripod to stabilize the camera during shooting.





Use this setting to capture a series of images that will be connected using a computer to form a panorama image ()2).

- Press the multi selector , , , or  to select the direction that you will move the camera in when capturing images, and press the  button.
- After shooting the first image, confirm on the screen how the captured image will be connected to the next image, and shoot the next image. Shoot as many images as needed to complete the panorama. To finish shooting, press the  button.
- Transfer the images to your computer and use the Panorama Maker 6 ( 75, )4) software to combine the images into a single panorama image.

Pet portrait



Use this mode when taking pictures of dogs or cats. When the camera detects the face of a dog or cat, the camera focuses on that face. Once the camera has focused, by default it automatically releases the shutter (pet portrait auto release).

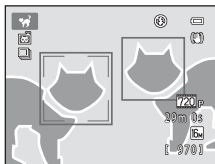

- From the screen displayed after the  **Pet portrait** scene mode is selected, select **Single** or **Continuous**.
 - Single:** Images are captured one at a time.
 - Continuous:** Three images are captured continuously when a face is focused on (at a rate of about 1.2 fps when **Image mode** is set to  **4608x3456**).
- When the camera detects a face, a double border (focus area) is displayed around the face, and the double border glows green when the camera has focused.

The faces of up to five pets can be detected at the same time. When the camera detects more than one face, the face displayed largest in the monitor is framed by a double border and the others by single borders.





- If no pet faces are detected, you can release the shutter by pressing the shutter-release button.
 - If no pet faces are detected, the camera focuses on the subject at the center of the frame.
 - When **Continuous** is selected, up to about four images are captured continuously at a rate of about 1.2 fps while the shutter-release button is held all the way down (when **Image mode** is set to  **4608x3456**).
- Press the multi selector  to change auto release settings. When set to **Off**, the shutter is released only when the shutter-release button is pressed.
- Pet portrait auto release** turns off automatically when:
 - Five bursts have been taken
 - Internal memory or the memory card is full

To continue using **Pet portrait auto release** to take more pictures, press the multi selector  and change the setting again.

- Digital zoom cannot be used.
- Depending on the distance of the pet from the camera, the speed of the pet's movement, the direction the pet is facing, the ambient brightness of the pet's face, etc., pet faces may not be detected or other subjects may be displayed with a border.

3D 3D photography

Use this mode for taking 3D images viewable in three dimensions on a 3D-compatible TV or monitor. The camera takes one picture for each eye to simulate a three-dimensional image. Images taken in this mode are saved at an image size of  (1920 × 1080).



- After taking the first picture, move the camera horizontally to the right so that the subject is aligned with the guide on the monitor. The camera takes the second picture automatically.
- The camera focuses at the center of the frame for the first shot.
The focus, exposure, and white balance set for the first shot are used for the second shot.
- Digital zoom cannot be used.
- The telephoto zoom position is limited to the angle of view equivalent to that of a 132 mm lens in 35mm [135] format.
- The angle of view (i.e., the area visible in the frame) seen in the saved image will be narrower than that seen in the monitor at the time of shooting.
- The two captured images are saved as a 3D picture (MPO file) consisting of the left and right eye images. The first image (the left eye image) is also saved as a JPEG file.
- 3D images cannot be played back in 3D on the camera monitor. Only the left eye image of a 3D image is displayed during playback.
- To view 3D images in 3D, connect the camera to a 3D-compatible TV or monitor using a 3D-compatible HDMI cable and configure the camera as described below using **TV settings** in the setup menu ( 88).
 - **HDMI:** Set to **Auto** (default setting) or **1080i**.
 - **HDMI 3D output:** Set to **On** (default setting).
- Taking 3D Pictures → 

Notes About Viewing 3D images

When viewing 3D images on a 3D-compatible TV or monitor for an extended period of time, you may experience discomfort such as eye strain or nausea. Carefully read the documentation included with your TV or monitor to ensure proper use.

Smart Portrait Mode (Capturing Smiling Faces)

When the camera detects a smiling face, you can take a picture automatically without pressing the shutter-release button (smile timer). You can use the skin softening option to smooth the skin tones in human faces.

Enter shooting mode →  (shooting mode) button →  Smart portrait mode →  button

1 Frame the picture.

- Raise the flash when using it (📖 5).
- When the camera detects a human face, a yellow double border (focus area) is displayed around that face. When the camera has focused on that face, the double border will turn green for a moment and focus is locked.
- Up to three faces can be detected. When the camera detects more than one face, a double border is displayed around the face closest to the center of the frame, and single borders are displayed around the other faces.

2 Wait for the subject to smile. Do not press the shutter-release button.

- If the camera detects that the face framed by the double border is smiling, the **Smile timer** (📖 46, 🎚️28) feature is activated and the shutter is automatically released.
- After the camera releases the shutter, it will continue to detect faces and smiles, and will release the shutter again if it detects a smiling face.

3 Shooting ends.

- Any of the following operations can be used to cancel smile detection and stop shooting.
 - Turn the camera off.
 - Set **Smile timer** (📖 46, 🎚️28) to **Off**.
 - Press the  button and select a different shooting mode.

Notes About Smart Portrait Mode

- Digital zoom cannot be used.
- Under some shooting conditions, the camera may be unable to detect faces or detect smiles.
- “Notes About Face Detection” →  65

Auto Off in Smile Timer Mode

When **Smile timer** is set to **On**, the auto off function ( 88) is activated and the camera turns off when either of the situations indicated below persists and no other operations are performed.

- The camera does not detect any faces.
- The camera detected a face, but cannot detect a smile.





When the Self-timer Lamp Flashes

When using smile timer, the self-timer lamp flashes when the camera detects a face and flashes quickly immediately after the shutter is released.

Releasing the Shutter Manually

The shutter can also be released by pressing the shutter-release button. If no faces are detected, the camera focuses on the subject at the center of the frame.

Changing Smart Portrait Mode Settings

- Features that can be set using the multi selector ( 50) → Flash mode ( 51), self-timer ( 55), and exposure compensation ( 59)
- Features that can be set by pressing the **MENU** button → Options Available in the Smart Portrait Menu ( 46)

Features That Cannot Be Used Simultaneously





Some settings cannot be used with other functions ( 64).

Options Available in the Smart Portrait Menu

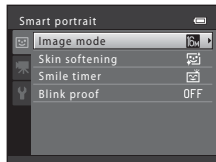
When using  smart portrait mode, the following settings can be changed.

Enter smart portrait mode ( 44) → MENU button →  tab



Option	Description	
Image mode	Allows you to select the combination of image size and image quality used when saving images ( 62). If you change the image mode setting, the new setting is applied to all shooting modes.	62
Skin softening	Enable skin softening. Make the skin tones in human faces smoother. The default setting is On .	 27
Smile timer	When On (default setting) is selected, the camera detects human faces and then automatically releases the shutter whenever a smile is detected. Self-timer cannot be used with this feature.	 28
Blink proof	When On is selected, the camera automatically releases the shutter twice each time a picture is taken. Of the two shots, the image in which the subject's eyes are more open compared to the other shot is saved. The flash cannot be used when On is selected. The default setting is Off .	 28

Features That Cannot Be Used Simultaneously

Some settings cannot be used with other functions ( 64).

Using Skin Softening

When the shutter is released in one of the following shooting modes, the camera detects one or more human faces (up to three), and processes the image to soften facial skin tones.

- **Portrait** (📖 36) or **Night portrait** (📖 37) in 📷 (easy auto) mode
- **Portrait** (📖 36) or **Night portrait** (📖 37) scene mode
- Smart portrait mode (📖 44)



Skin softening can also be applied to saved images (📖 70, 📷 11).

✔ **Notes About Skin Softening**

- It may take more time than usual to save images after shooting.
- Under some shooting conditions, the desired skin softening results may not be achieved, or skin softening may be applied to areas of the image where there are no faces.

(Auto) Mode

Used for general shooting. Settings can be adjusted in the shooting menu (📖 49) to suit the shooting conditions and the type of shot you want to capture.

Enter shooting mode →  (shooting mode) button →  (auto) mode →  button

- The camera focuses on the area in the center of the frame.

Changing (Auto) Mode Settings

- Features that can be set using the multi selector (📖 50) → Flash mode (📖 51), self-timer (📖 55), macro mode (📖 57), and exposure compensation (📖 59)
- Features that can be set by pressing the **MENU** button → Options Available in the Auto Shooting Menu (📖 49)





Features That Cannot Be Used Simultaneously





Some settings cannot be used with other functions (📖 64).

Options Available in the Auto Shooting Menu

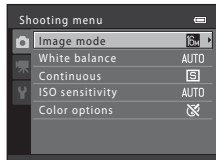
When using  (auto) mode, the following settings can be changed.

Enter  (auto) mode (📖 48) → MENU button →  tab



Option	Description	
Image mode	Allows you to select the combination of image size and image quality used when saving images (📖 62). This setting is also applied to other shooting modes.	62
White balance	Allows you to adjust white balance to suit the light source in order to make the colors in images match what you see with your eye. The available settings are Auto (default setting), Preset manual , Daylight , Incandescent , Fluorescent , Cloudy , and Flash .	 29
Continuous	Allows you to capture a series of images. The available settings are Single (default setting), Continuous , BSS , and Multi-shot 16 .	 32
ISO sensitivity	Control the camera's sensitivity to light. You can set sensitivity to Auto (default setting), or lock the setting at 80 , 100 , 200 , 400 , 800 , or 1600 . When ISO sensitivity is set to Auto , the camera sets the ISO sensitivity automatically, and ISO is displayed while shooting when ISO sensitivity increases.	 33
Color options	Allows you to change the color tones of images. The available settings are Standard color (default setting), Vivid color , Black-and-white , Sepia , and Cyanotype .	 34

Features That Cannot Be Used Simultaneously

Some settings cannot be used with other functions (📖 64).

Features That Can Be Set Using the Multi Selector

When shooting, the multi selector ▲, ▼, ◀, and ▶ can be used to set the following features.

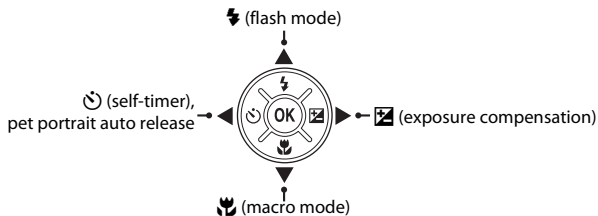

Available Features

The features that are available vary with the shooting mode, as shown below.

- See “Default Settings” (📖 60) for information about each mode’s default settings.

	📷 (easy auto)	Scene	Smart portrait	📷 (auto)
⚡ Flash mode ¹ (📖 51)	✓ ²	3	✓ ⁴	✓
🕒 Self-timer (📖 55)	✓		✓ ⁴	✓
Pet portrait auto release (📖 42)	–		–	–
🌸 Macro (📖 57)	–		–	✓
◻ Exposure compensation (📖 59)	✓		✓	✓

¹ Can be set when the flash is raised. When the flash is lowered, flash mode is fixed at 🕒 (off).

² Varies by the scene selected by the camera. → “Default Settings” (📖 60)

³ Varies by the scene. → “Default Settings” (📖 60)

⁴ Varies by the smart portrait menu setting. → “Default Settings” (📖 60)

Using the Flash (Flash Modes)

In dark locations or when the subject is backlit, you can take pictures with flash by raising the flash.

You can set the flash mode.

1 Press the (flash pop-up) button.

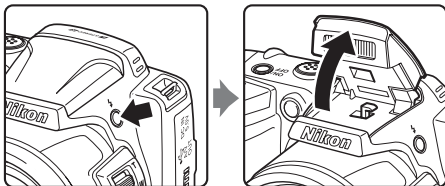

- The flash pops up.
- When the flash is lowered, flash mode is fixed at  (off).



2 Press the multi selector (flash mode).



3 Press the multi selector ▲ or ▼ to select the desired mode and press the **OK** button.

- Available Flash Modes →  53
- If a setting is not applied by pressing the **OK** button within a few seconds, the selection will be canceled.
- When **4**AUTO (auto) is applied, **EAUTO** is only displayed for a few seconds, regardless of **Monitor settings** ( 88,  51).



Lowering the Flash

Push the flash down gently to lower the flash until it clicks into place when not in use ( 5).

The Flash Lamp

The flash lamp indicates the status of the flash when you press the shutter-release button halfway.

- On: The flash fires when a picture is taken.
- Flashing: The flash is charging. The camera cannot take pictures.
- Off: The flash will not fire when a picture is taken.

If the battery is low, the monitor will turn off while the flash is charging.

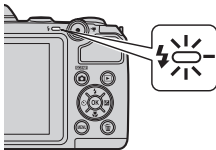

Effective Range of the Flash

When ISO sensitivity is set to **Auto**, the flash has a range of approx. 0.5 to 5.0 m (1 ft 8 in. to 16 ft) at the maximum wide-angle zoom position and a range of approx. 1.5 to 2.5 m (5 ft to 8 ft 2 in.) at the maximum telephoto zoom position.

Available Flash Modes



Auto

The flash fires automatically when lighting is dim.



Auto with red-eye reduction

Reduce red-eye in portraits caused by the flash (📖 54).



Off

The flash will not fire.

- We recommend using a tripod to stabilize the camera when shooting in dark surroundings.



Fill flash

The flash fires whenever a picture is taken. Use to “fill-in” (illuminate) shadows and backlit subjects.



Slow sync

Auto flash mode is combined with slow shutter speed.

Suited to evening and night portraits that include background scenery.

The flash illuminates main subject; slow shutter speeds are used to capture background at night or under dim lighting.

The Flash Mode Setting

- The setting varies with the shooting mode.
 - “Available Features” (📖 50)
 - “Default Settings” (📖 60)
- Some settings cannot be used with other functions (📖 64).
- The flash mode setting applied in  (auto) mode is saved in the camera’s memory even after the camera is turned off.

Red-eye Reduction

This camera uses **Advanced Red-Eye Reduction** (In-Camera Red-Eye Fix).

Pre-flashes are fired repeatedly at low intensity before the main flash, reducing the red-eye effect. Additionally, if the camera detects red eye while saving an image, the affected area will be processed to reduce red-eye before the image is saved.

Note the following when shooting:

- Because pre-flashes are fired, there is a slight lag between when the shutter-release button is pressed and when the shutter is released.
- More time than usual is required to save images.
- Red-eye reduction may not produce the desired results in all situations.
- In rare cases, areas of the image that are not affected by red-eye may be processed by red-eye reduction. In these cases, select another flash mode and take the picture again.

Using the Self-timer

The camera's self-timer can release the shutter about ten seconds after you press the shutter-release button.

The self-timer is useful when you want to be in the picture you are taking, or when you want to avoid the effects of camera shake that occur when you press the shutter-release button. When using the self-timer, use of a tripod is recommended. Set **Vibration reduction to Off** in the setup menu (📖 88) when using a tripod to stabilize the camera during shooting.

1 Press the multi selector ◀ (🕒 self-timer).



2 Press the multi selector ▲ or ▼ to select **ON** and press the Ⓞ button.

- 🕒10 is displayed.
- If a setting is not applied by pressing the Ⓞ button within a few seconds, the selection will be canceled.
- When the shooting mode is the **Pet portrait** scene mode, 📷 (Pet portrait auto release) is displayed (📖 42). Self-timer cannot be used.



3 Frame the picture and press the shutter-release button halfway.

- Focus and exposure will be set.



4 Press the shutter-release button the rest of the way down.

- The self-timer starts, and the number of seconds remaining before the shutter is released is displayed in the monitor. The self-timer lamp flashes while the timer is counting down. About one second before the shutter is released, the lamp stops flashing and glows steadily.
- When the shutter is released, the self-timer will be set to **OFF**.
- To stop the timer before a picture is taken, press the shutter-release button again.



Using Macro Mode

When using macro mode, the camera can focus on objects as close as about 1 cm (0.4 in.) from the lens.

This feature is useful when taking close-up pictures of flowers and other small subjects.

- 1 Press the multi selector ▼ (🌸 macro mode).



- 2 Press the multi selector ▲ or ▼ to select ON and press the OK button.

- The macro mode icon (🌸) is displayed.
- If a setting is not applied by pressing the OK button within a few seconds, the selection will be canceled.

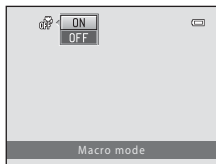

- 3 Use the zoom control or the side zoom control to set the zoom to a position where 🌸 and the zoom indicator glow green.



- How close you can be to the subject when shooting depends on the zoom position. When the zoom is set to a position where 🌸 and the zoom indicator glow green, the camera can focus on subjects as close as about 10 cm (4 in.) from the lens.
- When the zoom position is in the area indicated by ①, the camera can focus on objects as close as about 1 cm (0.4 in.) from the lens.

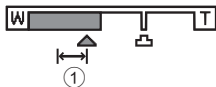

Notes About Using the Flash

The flash may be unable to light the entire subject at distances of less than 50 cm (1 ft 8 in.).

Autofocus

When shooting still images in macro mode, the camera focuses continuously until the shutter-release button is pressed halfway to lock the focus. You may hear the sound of the camera focusing.

The Macro Mode Setting

- Macro mode cannot be used when using certain shooting modes. → “Default Settings” (📖 60)
- The macro mode setting applied in  (auto) mode is saved in the camera’s memory even after the camera is turned off.

Adjusting Brightness (Exposure Compensation)

You can adjust overall image brightness.

- 1 Press the multi selector ► (☒ exposure compensation).



- 2 Press the multi selector ▲ or ▼ to select a compensation value.

- To make the image brighter, apply positive (+) exposure compensation.
- To make the image darker, apply negative (-) exposure compensation.

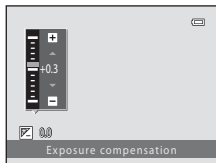

- 3 Press the **OK** button to apply the compensation value.

- If you do not press the **OK** button within a few seconds, the setting will be applied and the menu will disappear.
- When an exposure compensation value other than **0.0** is applied, the value is displayed with the ☒ indicator in the monitor.

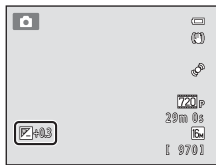

- 4 Press the shutter-release button to take a picture.









































- To turn off exposure compensation, return to step 1 and change the value to **0.0**.





Exposure Compensation Value

The exposure compensation value applied in  (auto) mode is saved in the camera's memory even after the camera is turned off.

Default Settings

Default settings for each shooting mode are described below.

	Flash ¹ (📖 51)	Self-timer (📖 55)	Macro (📖 57)	Exposure compensation (📖 59)
 (easy auto) (📖 34)	 AUTO ²	Off	Off ³	0.0
 (smart portrait) (📖 44)	 AUTO ⁴	Off ⁵	Off ⁶	0.0
 (auto) (📖 48)	 AUTO	Off	Off	0.0
Scene				
 (📖 36)		Off	Off ⁶	0.0
 (📖 36)		Off	Off ⁶	0.0
 (📖 37)		Off ⁶	Off ⁶	0.0
 (📖 37)		Off	Off ⁶	0.0
 (📖 37)		Off	Off ⁶	0.0
 (📖 38)	 AUTO	Off	Off ⁶	0.0
 (📖 38)	 AUTO	Off	Off ⁶	0.0
 (📖 38)		Off	Off ⁶	0.0
 (📖 38)		Off	Off ⁶	0.0
 (📖 39)		Off	Off ⁶	0.0
 (📖 39)		Off	On ⁶	0.0
 (📖 39)		Off	On ⁶	0.0
 (📖 40)		Off	Off	0.0
 (📖 40)		Off ⁶	Off ⁶	0.0 ⁶
 (📖 40)		Off	Off	0.0
 (📖 40)		Off	Off ⁶	0.0
 (📖 41)		Off	Off	0.0

	Flash ¹ (📖 51)	Self-timer (📖 55)	Macro (📖 57)	Exposure compensation (📖 59)
 (📖 42)	 ⁶	 ⁹	Off	0.0
3D (📖 43)	 ⁶	Off ⁶	Off	0.0

¹ Setting is used when the flash is raised.

² You can select  (auto) or  (off). When  (auto) is selected, the camera automatically selects the flash mode appropriate for the scene it has selected.

³ The setting cannot be changed. Automatically changes to macro mode when the camera selects **Close-up** scene mode.

⁴ Cannot be used when **Blink proof** is set to **On**.

⁵ Can be set when **Smile timer** is set to **Off**.

⁶ The setting cannot be changed.

⁷ The setting cannot be changed. The flash mode setting is fixed at fill flash with slow sync and red-eye reduction.

⁸ Slow sync with red-eye reduction flash mode may be used.

⁹ Self-timer cannot be used. Pet portrait auto release (📖 42) can be set to On or Off.

Features That Cannot Be Used Simultaneously

Some settings cannot be used with other functions (📖 64).











Changing the Image Size (Image Mode)

Enter shooting mode → MENU button → Shooting menu → Image mode →  button

You can use the **Image mode** setting in the shooting menu to select the combination of image size and compression ratio that is used when saving images.



Select the image mode best suited to the manner in which images will be used and the capacity of the internal memory or memory card.

Image Mode Settings (Image Size and Quality)

Image mode*	Description
 4608×3456 ★	Images will be higher quality than  . The compression ratio is approximately 1:4.
 4608×3456 (default setting)	Best choice in most situations. The compression ratio is approximately 1:8.
 3264×2448	
 2272×1704	
 1600×1200	Smaller size than  ,  , or  and therefore allows more images to be saved. The compression ratio is approximately 1:8.
 640×480	Suited to full-screen display on a TV with an aspect ratio of 4:3, or distribution by e-mail. The compression ratio is approximately 1:8.
 4608×2592	Images with an aspect ratio of 16:9 are saved. The compression ratio is approximately 1:8.







* The total number of pixels captured, and the number of pixels captured horizontally and vertically.
Example:  **4608×3456** = approx. 16 megapixels = 4608×3456 pixels

Notes About Image Mode

- The setting is also applied to other shooting modes.
- Some settings cannot be used with other functions ( 64).
- Image mode cannot be selected when using the **3D photography** scene mode ( 43).

Number of Images That Can Be Saved

The following table lists the approximate number of images that can be saved in the internal memory and on a 4 GB memory card. Note that due to JPEG compression, the number of images that can be saved varies greatly depending on the composition of the image. In addition, this number varies depending on the make of the memory card, even when the memory cards have the same specified capacity.

Image mode	Internal memory (approx. 50 MB)	Memory card ¹ (4 GB)	Print size ² (cm/in.)
 4608×3456 ★	6	490	39 × 29/15 × 11.5
 4608×3456	12	970	39 × 29/15 × 11.5
 3264×2448	24	1910	28 × 21/11 × 8
 2272×1704	48	3820	19 × 14/7.5 × 5.6
 1600×1200	95	7240	13 × 10/5.3 × 4
 640×480	256	27700	5 × 4/2 × 1.5
 4608×2592	16	1290	39 × 22/15 × 8.5

¹ If the number of exposures remaining is 10,000 or more, the number of exposures remaining display shows "9999".

² Print size at an output resolution of 300 dpi.

Print sizes are calculated by dividing the number of pixels by printer resolution (dpi) and multiplying by 2.54 cm (1 in.). However, at the same image size, images printed at higher resolutions will print smaller than the size indicated, and those printed at lower resolutions will print larger than the size indicated.

Features That Cannot Be Used Simultaneously

Some shooting settings cannot be used with other functions.

Restricted function	Option	Descriptions
Flash mode	Continuous (📖 49)	When Continuous , BSS , or Multi-shot 16 is selected, the flash cannot be used.
	Blink proof (📖 46)	When Blink proof is set to On , the flash cannot be used.
Self-timer	Smile timer (📖 46)	When Smile timer is used for shooting, the self-timer cannot be used.
Digital zoom	Continuous (📖 49)	When Multi-shot 16 is selected, digital zoom cannot be used.
Image mode	Continuous (📖 49)	When Multi-shot 16 is selected, the Image mode setting is fixed at 5M (image size: 2560 × 1920 pixels).
White balance	Color options (📖 49)	When using Black-and-white , Sepia , or Cyanotype , the White balance setting is fixed at Auto .
Continuous	Self-timer (📖 55)	When using the self-timer, Continuous is fixed at Single .
ISO sensitivity	Continuous (📖 49)	When Multi-shot 16 is selected, the ISO sensitivity setting is automatically specified according to the brightness.
Motion detection	Continuous (📖 49)	When Multi-shot 16 is selected, Motion detection is disabled.
	ISO sensitivity (📖 49)	When the ISO sensitivity is set to any setting other than Auto , Motion detection is disabled.
Shutter sound	Continuous (📖 49)	When Continuous , BSS , or Multi-shot 16 is selected, the shutter sound is not heard.

Focusing

Using Face Detection

In the following shooting modes, the camera uses face detection to automatically focus on human faces.

If the camera detects more than one face, a double border is displayed around the face that the camera will focus on, and single borders are displayed around the other faces.

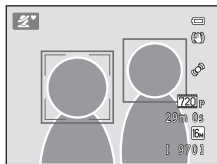

Shooting mode	Number of faces that can be detected	Focus area (double border)
Portrait (📖 36) and Night portrait (📖 37) in 📷 (easy auto) mode	Up to 12	The face closest to the camera
Portrait (📖 36) and Night portrait (📖 37) scene modes		
Smart portrait mode (📖 44)	Up to 3	The face closest to the center of the frame

- If no faces are detected when the shutter-release button is pressed halfway, the camera will focus on the subject in the center of the frame.

👍 Notes About Face Detection

- The camera's ability to detect faces depends on a variety of factors, including whether or not the subject is facing the camera. Additionally, the camera may be unable to detect faces in the following situations:
 - When faces are partially hidden by sunglasses or otherwise obstructed
 - When faces take up too much or too little of the frame
- When the frame includes more than one face, the faces detected by the camera and the face on which the camera focuses depend upon a variety of factors, including the direction in which the faces are looking.
- In some rare cases, such as those described in "Autofocus" (📖 28), the subject may not be in focus even though the double border turns green. Should this occur, use another mode, such as 📷 (auto) mode, and try focus lock shooting (📖 66) by focusing on another subject that is the same distance from the camera.

Focus Lock

When the camera focuses on an object in the center of the frame, you can use focus lock to focus on an off-center subject.

Use the following procedure when taking pictures using  (auto) mode.

1 Aim the camera so that the subject is in the center of the frame.

2 Press the shutter-release button halfway.

- Confirm that the focus area glows green.
- Focus and exposure are locked.



3 Continue holding down the shutter-release button halfway and recompose the picture.

- Be sure to maintain the same distance between the camera and the subject while the shutter-release button is pressed halfway.

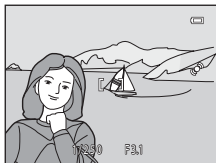

4 Press the shutter-release button the rest of the way down to take the picture.



Playback Features

This chapter describes the features that are available when playing back images.

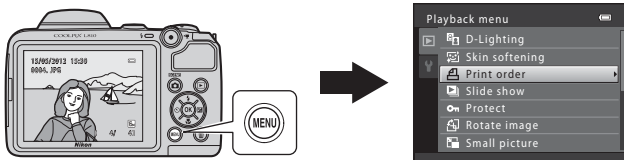

Playback Zoom	68
Thumbnail Display, Calendar Display.....	69
Features Available in Playback Mode (Playback Menu) ...	70
Connecting the Camera to a TV, Computer, or Printer ...	71
Using ViewNX 2.....	73
Installing ViewNX 2.....	73
Transferring Images to the Computer	76
Viewing Images.....	78

Playback Zoom

Rotating the zoom control to **T** (📏) in full-frame playback mode (📖 29) zooms in on the center of the image displayed in the monitor.

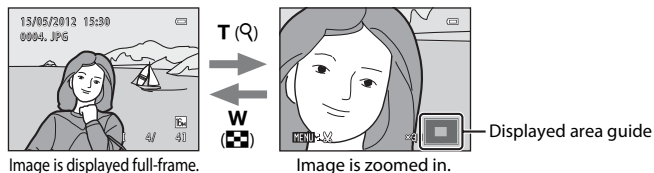

- You can change the zoom ratio by rotating the zoom control to **W** (📐) and **T** (📏). Images can be zoomed up to approximately 10x.
- To view a different area of the image, press the multi selector ▲, ▼, ◀, or ▶.
- If you are viewing an image that was captured using face detection (📖 65) or pet detection (📖 42), the camera zooms in on the face detected at the time of shooting. If the camera detected multiple faces when the image was captured, press ▲, ▼, ◀, or ▶ to display a different face. To zoom in on an area of the image where there are no faces, adjust the magnification rate and then press ▲, ▼, ◀, or ▶.
- You can crop the image and save the displayed area of the image as a separate file by pressing the **MENU** button (🔑 13).
- Press the **OK** button to return to full-frame playback mode.

Thumbnail Display, Calendar Display

Rotating the zoom control to **W** (📐) in full-frame playback mode (📖 29) displays images in “contact sheets” of thumbnail images.





















- You can view several images on one screen, making it easy to find the image you want.
- You can change the number of thumbnails displayed by rotating the zoom control to **W** (📐) and **T** (🔍).
- Press the multi selector **▲**, **▼**, **◀**, or **▶** to select an image, and then press the **OK** button to display that image full-frame.
- When 16 thumbnails are displayed, rotate the zoom control to **W** (📐) to switch to calendar display.
- While using calendar display mode, press **▲**, **▼**, **◀**, or **▶** to select a date and then press the **OK** button to display the first image captured on that day.





📅 Calendar Display

Images captured when the camera's date is not set are treated as images captured on January 1, 2012.

Features Available in Playback Mode (Playback Menu)

When viewing images in full-frame playback mode or thumbnail playback mode, you can configure the following functions by pressing the **MENU** button ( 3) to display the menu.

Option	Description	
 D-Lighting ^{1,2}	Allows you to create copies with enhanced brightness and contrast, brightening dark portions of an image.	 10
 Skin softening ^{1,2}	The camera detects faces in images and creates a copy with softer facial skin tones.	 11
 Print order ²	When using a printer to print images saved on the memory card, you can use the Print order function to select which images are printed, and how many copies of each image are printed.	 35
 Slide show	Allows you to view images saved in the internal memory or on a memory card in an automatic slide show.	 38
 Protect	Protects selected images from accidental deletion.	 39
 Rotate image ²	Specifies the orientation in which saved images are displayed with playback.	 41
 Small picture ^{1,2}	Creates a small copy of the current image. This feature is useful for creating copies for display on Web pages or e-mail attachments.	 12
 Copy	Allows you to copy images between the internal memory and a memory card.	 42

¹ Images are edited and saved as separate files. Certain restrictions apply ( 8,  9). For example, images captured at an **Image mode** ( 62) setting of  **4608x2592** cannot be edited, and the same editing feature cannot be applied multiple times.

² Cannot be applied to images captured in the **3D photography** ( 43) scene mode.

Connecting the Camera to a TV, Computer, or Printer

You can enhance your enjoyment of images and movies by connecting the camera to a TV, computer, or printer.

- Before connecting the camera to an external device, make sure the remaining battery level is sufficient and turn the camera off. For information about the connection methods and subsequent operations, refer to the documentation included with the device in addition to this document.

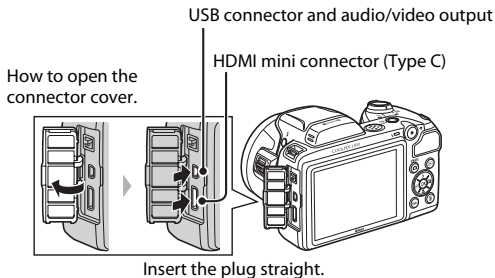

Viewing images on a TV

 17

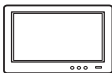

You can view the camera's images and movies on a TV.

Connection method: Connect the video and audio plugs of the included Audio Video Cable EG-CP16 to the TV's input jacks. Alternatively, connect a commercially available HDMI cable (Type C) to the TV's HDMI input jack.

Viewing and organizing images on a computer

 73



If you transfer images to a computer, you can perform simple retouching and manage image data in addition to playing back images and movies.

Connection method: Connect the camera to the computer's USB input jack with the included USB Cable.

- Before connecting to a computer, install ViewNX 2 on the computer using the included ViewNX 2 Installer CD-ROM. For information about using the ViewNX 2 Installer CD-ROM and transferring images to a computer, see page 73.

Printing images without using a computer

 20



If you connect the camera to a PictBridge-compatible printer, you can print images without using a computer.

Connection method: Connect the camera directly to the printer's USB input jack with the included USB Cable.

Using ViewNX 2

ViewNX 2 is an all-in-one software package which enables you to transfer, view, edit and share images.

Install ViewNX 2 using the ViewNX 2 Installer CD-ROM.



Installing ViewNX 2

- An Internet connection is required.

Compatible Operating Systems

Windows

- Windows 7 Home Basic/Home Premium/Professional/Enterprise/Ultimate (Service Pack 1)
- Windows Vista Home Basic/Home Premium/Business/Enterprise/Ultimate (Service Pack 2)
- Windows XP Home Edition/Professional (Service Pack 3)

Mac OS

- Mac OS X (version 10.5.8, 10.6.8, 10.7.2)

Refer to the Nikon website for the latest information on operating system compatibility.

1 Start the computer and insert the ViewNX 2 Installer CD-ROM into the CD-ROM drive.

- Mac OS: When the **ViewNX 2** window is displayed, double-click the **Welcome** icon.

2 Select a language in the language selection dialog to open the installation window.

- If the desired language is not available, click **Region Selection** to choose a different region and then choose the desired language (the **Region Selection** button is not available in the European release).
- Click **Next** to display the installation window.

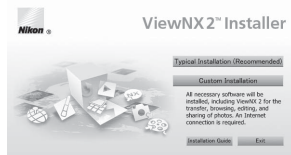
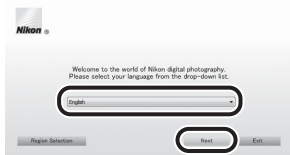

3 Start the installer.

- We recommend clicking **Installation Guide** in the installation window to check the installation help information and system requirements before installing ViewNX 2.
- Click **Typical Installation (Recommended)** in the installation window.

4 Download the software.

- When the **Software Download** screen is displayed, click **I agree - Begin download**.
- Follow the on-screen instructions to install the software.

5 Exit the installer when the installation completion screen is displayed.

- Windows: Click **Yes**.
- Mac OS: Click **OK**.

The following software is installed:

- ViewNX 2 (consisting of the three modules below)
 - Nikon Transfer 2: For transferring images to the computer
 - ViewNX 2: For viewing, editing, and printing transferred images
 - Nikon Movie Editor: For basic editing of transferred movies
- Panorama Maker 6 (for creating a single panorama photo using a series of images shot in panorama assist scene mode)
- QuickTime (Windows only)

6 Remove the ViewNX 2 Installer CD-ROM from the CD-ROM drive.

Transferring Images to the Computer

1 Choose how images will be copied to the computer.

Choose one of the following methods:

- **Direct USB connection:** Turn the camera off and ensure that the memory card is inserted in the camera. Connect the camera to the computer using the supplied USB Cable. Turn the camera on. To transfer images that are saved in the camera's internal memory, remove the memory card from the camera before connecting it to the computer.

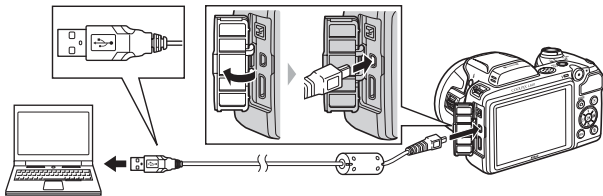

- **SD card slot:** If your computer is equipped with an SD card slot, the card can be inserted directly in the slot.
- **SD card reader:** Connect a card reader (available separately from third-party suppliers) to the computer and insert the memory card.

If a message is displayed prompting you to choose a program, select Nikon Transfer 2.

• When using Windows 7

If the dialog shown at right is displayed, follow the steps below to select Nikon Transfer 2.

- 1 Under **Import pictures and videos**, click **Change program**. A program selection dialog will be displayed; select **Import File using Nikon Transfer 2** and click **OK**.
- 2 Double-click **Import File**.



If the memory card contains a large number of images, it may take a while for Nikon Transfer 2 to start. Wait until Nikon Transfer 2 starts.

Connecting the USB Cable

The connection may not be recognized if the camera is connected to the computer via a USB hub.

2 Transfer images to the computer.

- Confirm that the name of the connected camera or removable disk is displayed as the “Source” on the “Options” title bar of Nikon Transfer 2 (①).
- Click **Start Transfer** (②).

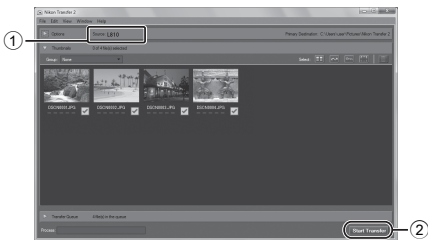

- At default settings, all the images on the memory card will be copied to the computer.

3 Terminate the connection.

- If the camera is connected to the computer, turn the camera off and disconnect the USB cable. If you are using a card reader or card slot, choose the appropriate option in the computer operating system to eject the removable disk corresponding to the memory card and then remove the card from the card reader or card slot.

Viewing Images

Start ViewNX 2.

- Images are displayed in ViewNX 2 when transfer is complete.
- Consult online help for more information on using ViewNX 2.



Starting ViewNX 2 Manually

- **Windows:** Double-click the **ViewNX 2** shortcut icon on the desktop.
- **Mac OS:** Click the **ViewNX 2** icon in the Dock.

Recording and Playing Back Movies

You can record movies by simply pressing the  movie-record button.

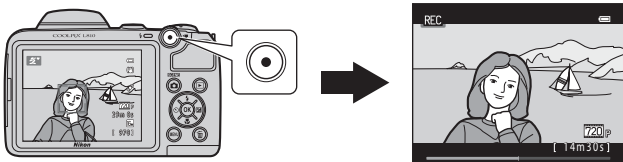

Recording Movies	80
Changing Movie Recording Settings (the Movie Menu)	83
Playing Back Movies	84

Recording Movies

You can record movies by simply pressing the **●** (movie-record) button.

1 Display the shooting screen.

- The icon for the selected movie option is displayed. The default setting is **720p HD 720p (1280×720)** (83).

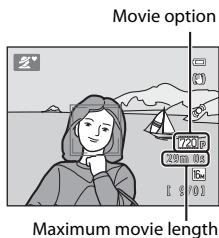



2 Lower the flash (85)

- Recording movies while the flash is raised may cause the audio to be muffled.

3 Press the **●** (movie-record) button to start movie recording.

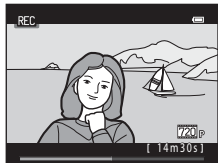
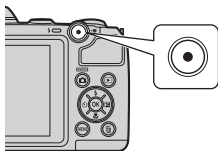
- The camera focuses on the subject in the center of the frame. Focus areas are not displayed during recording.
- When **Movie options** is set to **720p HD 720p (1280×720)**, the monitor display changes to a 16:9 aspect ratio when recording movies.
- If **Photo info** in the **Monitor settings** (88) in the setup menu is set to **Movie frame+auto info**, the area that will be visible in the movie can be confirmed before movie recording starts.
- []** is displayed while saving to the internal memory.



4 Press the  (movie-record) button again to end recording.

Notes About Saving Data

After taking pictures or recording a movie, the number of exposures remaining or the remaining recording time flashes while images or movies are being saved. **Do not open the battery-chamber/memory card slot cover** while images or movies are being saved. Image and movie data could be lost and the camera or memory card could be damaged.

Notes About Movie Recording

- Memory cards with an SD Speed Class rating of 6 or faster are recommended when recording movies (📖 15). Movie recording may stop unexpectedly when memory cards with a lower Speed Class rating are used.
- There may be some degradation in image quality when digital zoom is used. If the digital zoom is not being used when movie recording begins, turning and holding the zoom control or the side zoom control toward **T** magnifies the image using optical zoom and the zoom stops at the maximum optical zoom ratio. After letting go of the zoom control, turn the zoom control toward **T** again to magnify the image using the digital zoom.
- When recording ends, digital zoom turns off.
- The sounds of zoom control operation, zoom, autofocus lens drive movement, vibration reduction, and aperture operation when brightness changes may be recorded.
- Smear (👁️-3) visible in the monitor with movie recording will be recorded with movies. Avoiding bright objects such as the sun, reflections of the sun, and electric lights is recommended.
- Depending on the distance to the subject or the amount of zoom applied, subjects with repeating patterns (fabrics, lattice windows, etc.) may have colored stripes (interference patterns, moire, etc.) in them during movie recording and playback. This occurs when the pattern in the subject and the layout of the image sensor interfere with each other; it is not a malfunction.
- The camera may become warm when shooting movies for an extended period of time or when the camera is used in a hot area.

Notes About Autofocus

Autofocus may not perform as expected (📖 28). Should this occur, try the following:

1. Set **Autofocus mode** in the movie menu to **AF-S Single AF** (default setting) before starting movie recording (📖 83, 📷45).
2. Frame another subject—positioned at the same distance from the camera as the intended subject—in the center of the frame, press the  (movie-record) button to start recording, and then modify the composition.



Movie Options and Maximum Movie Length

Movie options (📖 83)	Internal memory (approx. 50 MB)	Memory card (4 GB)*
720p HD 720p (1280×720) (default setting)	31 s	45 min
VGA VGA (640×480)	1 min 17 s	1 h 50 min



All figures are approximate. The maximum movie length may vary depending on the make of the memory card, even among memory cards of the same capacity.

* The maximum size for a single movie is 4 GB, and the maximum movie length for a single movie is 29 minutes, even when there is sufficient free space on the memory card. When recording a movie, the remaining recording time that is displayed is the amount of recording time available for one movie.

Functions Available with Movie Recording





- The exposure compensation, white balance, and color options settings for the current shooting mode are also applied with movie recording. The tone that results from using scene mode (📖 35) is also applied to movies. When macro mode is enabled, movies of subjects closer to the camera can be recorded. Confirm settings before starting movie recording.
- The self-timer (📖 55) can be used. Set the self-timer and press the  (movie-record) button to start recording a movie after ten seconds.
- The flash will not fire.
- Press the **MENU** button to select the  (movie) tab and adjust movie menu settings before starting movie recording (📖 83).

Changing Movie Recording Settings (the Movie Menu)

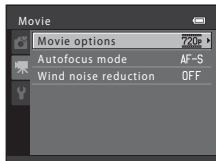
Enter shooting mode → MENU button →  tab →  button

The following settings can be changed.



Option	Description	
Movie options	The following movie types are available: 720p HD 720p (1280×720) and VGA VGA (640×480) .	 44
Autofocus mode	When AF-S Single AF (default setting) is selected, focus is locked when movie recording begins. When AF-F Full-time AF is selected, the camera focuses continuously while recording. When AF-F Full-time AF is selected, the sound of the camera focusing may be heard in recorded movies. If you want to prevent the sound of the camera focusing from being recorded, select AF-S Single AF .	 45
Wind noise reduction	Set whether or not to reduce wind noise during movie recording.	 45

Playing Back Movies

Press the  button to enter playback mode.





Movies are indicated by the movie options icon ( 83).

Press the  button to play back movies.

Movie options



Deleting Movies

To delete a movie, select the desired movie in full-frame playback mode ( 29) or thumbnail playback mode ( 69) and press the  button ( 31).

Functions Available During Playback

Playback controls are displayed at the top of the monitor.

Press the multi selector ◀ or ▶ to select a control. The operations described below are available.



Function	Icon	Description
Rewind	◀	Hold down the OK button to rewind the movie.
Advance	▶	Hold down the OK button to advance the movie.
Pause	⏸	Press the OK button to pause playback. The following operations can be performed while playback is paused using the controls displayed at the top in the monitor.
		Press the OK button to rewind the movie. Hold down the OK button for continuous rewinding.
		Press the OK button to advance the movie. Hold down the OK button for continuous advancing.
		Press the OK button to resume playback.
	✂	Press the OK button to cut unwanted portions of a movie so that only the desired portions of a movie are saved (🎞 15).
End	■	Press the OK button to return to full-frame playback mode.

Adjusting Volume

Rotate the zoom control to **T** or **W** (📖 2) during playback.



Volume indicator

Notes About Playing Back Movies

The COOLPIX L810 is not able to play back movies recorded with another make or model of digital camera.



A series of ten horizontal dashed lines spanning the width of the page, intended for handwriting practice.

General Camera Setup

This chapter describes the various settings that can be adjusted in the  setup menu.

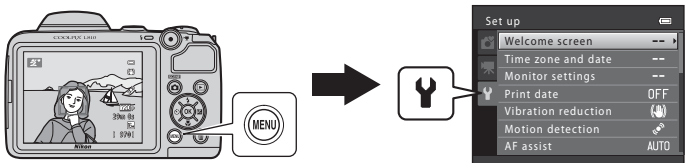









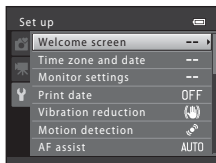

For further details about each setting, refer to “The Setup Menu” in the Reference Section (46).









The Setup Menu

Press the **MENU** button → **Y** (setup) tab → **OK** button

The following settings can be changed in the setup menu by selecting the **Y** tab.



Option	Description	
Welcome screen	Allows you to select whether or not a welcome screen is displayed when the camera is turned on.	 46
Time zone and date	Allows you to set the camera clock and select the home and destination time zones.	 47
Monitor settings	Allows you to adjust photo information display and monitor brightness settings.	 51
Print date	Allows you to imprint the shooting date and time on images.	 53
Vibration reduction	Reduce the effects of camera shake while shooting.	 54
Motion detection	Allows you to set whether or not the camera automatically increases the shutter speed to reduce blurring caused by camera shake when motion is detected when shooting still images.	 55
AF assist	Allows you to enable and disable the AF-assist illuminator.	 56
Sound settings	Allows you to adjust sound settings.	 57
Auto off	Allows you to set the amount of time that passes before the monitor turns off to save power.	 58

Option	Description	
Format memory/ Format card	Allows you to format the internal memory or the memory card.	 59
Language	Allows you to change the camera's display language.	 60
TV settings	Allows you to adjust TV-connection settings.	 61
Blink warning	Allows you to set whether or not closed eyes are detected when taking pictures of people using face detection.	 62
Eye-Fi upload	Allows you to set whether or not the camera's Eye-Fi card (available from third-party manufacturers) sends images to your computer.	 64
Reset all	Allows you to reset the camera's settings to their default values.	 65
Battery type	Change this setting to match the type of batteries that are inserted in the camera.	 68
Firmware version	Allows you to confirm the camera's firmware version.	 68



A series of ten horizontal dashed lines spanning the width of the page, intended for handwriting practice.



Technical Notes and Index

Caring for the Product	2
The Camera.....	2
Batteries.....	4
Memory Cards.....	6
Cleaning and Storage	7
Cleaning.....	7
Storage.....	7
Troubleshooting	8
Specifications	16
Supported Standards.....	20
Index	21

Caring for the Product

The Camera

To ensure safe and continued enjoyment of your Nikon camera, observe the following precautions and the precautions noted in “For Your Safety” (📖 viii-xv) when using or storing your camera.

✔ **Do Not Subject the Product to Strong Shocks**

The product may malfunction if dropped or struck. Additionally, do not touch or apply force to the lens.

✔ **Keep Dry**

If water enters the camera, internal components may rust or otherwise become damaged, and repairing the camera may be expensive or even impossible.

✔ **Avoid Sudden Changes in Temperature**

Sudden changes in temperature, such as when entering or leaving a heated building on a cold day, can cause condensation to form inside the device. To prevent condensation, place the device in a carrying case or a plastic bag before exposing it to sudden changes in temperature.

✔ **Keep away from Strong Magnetic Fields**

Do not use or store this device in the vicinity of equipment that generates strong electromagnetic radiation or magnetic fields. Strong static charge or the magnetic fields produced by equipment such as radio transmitters could interfere with the monitor, damage data saved on the memory card, or affect the product’s internal circuitry.

✔ **Do Not Point the Lens at Strong Light Sources for Extended Periods**

Avoid pointing the lens at the sun or other strong light sources for extended periods when using or storing the camera. Intense light may damage the image sensor or other components, producing a white blur effect in photographs.

Turn the Camera off Before Removing the Batteries, AC Adapter, or Memory Card

Removing the batteries, AC adapter, or memory card while the camera is on could damage the camera or memory card. If removed while the camera is saving or deleting data, data may be lost and the camera's memory or the memory card may be damaged.

Notes on the Monitor

- Monitors and electronic viewfinders are constructed with extremely high precision; at least 99.99% of pixels are effective, with no more than 0.01% being missing or defective. Hence while these displays may contain pixels that are always lit (white, red, blue, or green) or always off (black), this is not a malfunction and has no effect on images recorded with the device.
- Scraping or pressing on the surface of the monitor may result in damage or malfunction. Should the monitor break, care should be taken to avoid injury caused by broken glass and to prevent the liquid crystal from the display touching the skin or entering the eyes or mouth.
- Images in the monitor may be difficult to see under bright lighting.
- The monitor is lit by an LED backlight. Should the monitor begin to dim or flicker, contact your Nikon-authorized service representative.

Notes About Smear

White or colored streaks may be visible when bright subjects are framed in the monitor. This phenomenon, known as “smear,” occurs when extremely bright light strikes the image sensor; it is characteristic of image sensors and does not indicate a malfunction. Smear may also take the form of partial discoloration in the monitor during shooting. It does not appear in images saved with the camera except in the cases of movies and of images saved with **Multi-shot 16** selected for **Continuous**. When shooting in these modes, we recommend that you avoid bright subjects such as the sun, reflected sunlight, and electric lights.

Batteries

Be sure to read and follow the warnings noted in “For Your Safety” ( viii-xv) before use.

Notes About Using Batteries

- Used batteries may overheat. Handle with caution.
- Do not use batteries beyond their recommended expiration date.
- Do not turn the camera on and off repeatedly if discharged batteries are inserted in the camera.

Spare Batteries

We recommend carrying spare batteries depending on where you are shooting. It may be difficult to purchase batteries in certain areas.

Charging Batteries

If using optional rechargeable batteries, charge the batteries before taking pictures. Batteries are not charged at the time of purchase.

Be sure to read and follow the warnings noted in the operating instructions included with the battery charger.

Charging Rechargeable Batteries

- Do not mix batteries with different amounts of charge remaining, or batteries of a different make or model.
- When using EN-MH2 batteries with the COOLPIX L810, charge the batteries four at a time using Battery Charger MH-73. Use only Battery Charger MH-73 to charge EN-MH2 batteries.
- When using Battery Charger MH-73, only charge EN-MH2 batteries.
- EN-MH1 rechargeable Ni-MH batteries cannot be used.

Notes About Rechargeable Ni-MH Batteries

- If you repeatedly charge rechargeable Ni-MH batteries while they still have some charge remaining, the message **Battery exhausted.** may be displayed prematurely when using the batteries. This is due to the “memory effect,” in which the amount of charge the batteries can hold decreases temporarily. Use the batteries until there is no charge remaining and they will return to their normal behavior.
- Rechargeable Ni-MH batteries discharge even when not being used. We recommend charging the batteries just before using them.

Cold Environment Usage

Battery performance decreases in cold environments. When using the camera in cold environments, try not to let the camera and batteries become too cold. The camera may not function if you use discharged batteries in cold environments. Keep spare batteries warm and alternate between two sets of batteries. Batteries that cannot be used because they have become too cold can often be used again when they have been warmed up.

Battery Terminals

Dirt on the battery terminals can prevent the camera from functioning. Remove dirt from the terminals using a dry cloth.



Remaining Battery Charge

If you insert discharged batteries into the camera, the camera may indicate that the batteries have adequate charge remaining. This is a characteristic of batteries.

Recycling

Used batteries are a valuable resource. Please recycle used batteries in accordance with local regulations. Cover the battery terminals with tape when recycling.

Memory Cards

- Use only Secure Digital memory cards. Approved memory cards →  15
- Observe the precautions noted in the documentation included with your memory card.
- Do not affix labels or stickers to the memory card.
- Do not format the memory card using a computer.
- Before using a memory card with this camera, format the card using this camera if the card has been used with another device. Before using a new memory card, we recommend using this camera to format the card.
- Note that **formatting a memory card permanently deletes all images and other data on the memory card**. If there is data saved on the memory card that you wish to keep, copy that data to a computer before formatting.
- If the message **Card is not formatted. Format card?** is displayed when you insert a memory card, the memory card must be formatted. If there is data on the memory card that you do not want to delete, select **No**. Copy that data to a computer before formatting. To format the memory card, select **Yes** and press the  button.
- Observe the following precautions while formatting the memory card, saving and deleting images, and copying images to a computer, otherwise data on the memory card itself may be damaged.
 - Do not open the battery-chamber/memory card slot cover or remove the memory card or batteries.
 - Do not turn off the camera
 - Do not disconnect the AC adapter

Cleaning and Storage

Cleaning

Do not use alcohol, thinner, or other volatile chemicals.

Lens	When cleaning the lens, avoid touching it directly with your fingers. Remove dust or lint with a blower. To remove fingerprints, oil, or other grime that cannot be removed with a blower, wipe the lens with a soft, dry cloth or an eyeglass cleaning cloth, using a gentle spiral motion that starts in the center and moves toward the edges. Do not wipe forcefully or wipe with a rough cloth, otherwise the camera may be damaged or malfunction. If you still cannot remove the grime, wet a soft cloth with a commercial liquid lens cleaner and gently wipe off the grime.
Monitor	Remove dust or lint with a blower. To remove fingerprints, oil, or other grime, wipe the area with a soft, dry cloth or an eyeglass cleaning cloth. Do not wipe forcefully or wipe with a rough cloth, otherwise the camera may be damaged or malfunction.
Body	<ul style="list-style-type: none">• Remove dust or lint with a blower. Wipe with a soft, dry cloth.• After using the camera at the beach or other sandy or dusty environment, wipe off any sand, dust, or salt with a dry cloth lightly dampened with fresh water and dry thoroughly. <p><i>Note that foreign matter inside the camera could cause damage not covered by the warranty.</i></p>

Storage









Remove the batteries if the camera will not be used for an extended period. To prevent mold or malfunction and to ensure long, trouble-free use of the camera, we recommend you insert the batteries and operate the camera approximately once a month. Do not store the camera with naphtha or camphor moth balls, or in any of the following locations:





- Next to equipment that produces strong electromagnetic fields, such as televisions or radios
- Places that are exposed to temperatures below -10°C (14°F) or above 50°C (122°F)
- Places that are poorly ventilated or subject to humidity of over 60%

Troubleshooting

If the camera fails to function as expected, check the list of common problems below before consulting your retailer or Nikon-authorized service representative.

Power, Display, Settings Issues







Problem	Cause/Solution	
Camera turns off without warning.	<ul style="list-style-type: none">• Battery is exhausted.• Camera has turned off automatically to save power.• The camera or battery have become too cold and cannot operate properly.	21 88,  58  4
Monitor is blank.	<ul style="list-style-type: none">• Camera is off.• Battery is exhausted.• Standby mode for saving power: press the power switch, the shutter-release button,  button,  button, or  (movie-record) button.• The flash lamp flashes while the flash is charging. Wait for the flash to charge.• Camera and computer are connected via USB cable.• Camera and TV are connected via audio/video cable or HDMI cable.	22 21 2, 22 52 71, 76 71,  17
Monitor is hard to read.	<ul style="list-style-type: none">• Adjust monitor brightness.• Monitor is dirty. Clean monitor.	88,  51  7











Problem	Cause/Solution	
Date and time of recording are not correct.	<ul style="list-style-type: none"> If camera clock has not been set, "Date not set" indicator flashes during shooting and movie recording. Images and movies saved before clock is set are dated "00/00/0000 00:00" or "01/01/2012 00:00" respectively. Set the correct time and date from the Time zone and date option in the setup menu. Check camera clock regularly against more accurate timepieces and reset as required. 	16, 88,  47
No indicators displayed in monitor.	Hide info is selected for Photo info . Select Show info .	88,  51
Print date not available.	Time zone and date has not been set.	16, 88,  47
Date not imprinted on images even when Print date is enabled.	<ul style="list-style-type: none"> The current shooting mode is one that does not support Print date. The date cannot be imprinted on movies. 	88,  53
Screen for setting time zone and date is displayed when camera is turned on.	Clock battery is exhausted; all settings were restored to their default values.	16, 19
Camera settings reset.		
Camera becomes hot.	The camera may become hot when shooting movies or uploading images from an Eye-Fi card for an extended period of time, or when the camera is used in a hot area; this is not a malfunction.	-







Characteristics of Digital Cameras









In extremely rare instances, unusual characters may appear in the monitor and the camera may stop functioning. In most cases, this phenomenon is caused by a strong external static charge. Turn the camera off, remove and replace the batteries, then turn the camera on again. In the event of continued malfunction, contact your retailer or Nikon-authorized service representative. Note that disconnecting the power source as described above may result in the loss of any data not saved to internal memory or the memory card at the time the problem occurred. Data already saved will not be affected.

Shooting Issues









Problem	Cause/Solution	
Cannot switch to shooting mode.	Disconnect the HDMI cable or USB cable.	71, 76,  17,  20
No image captured when the shutter-release button is pressed.	<ul style="list-style-type: none">• When camera is in playback mode, press the  button, the shutter-release button, or the  (▶) (movie-record) button.• When menus are displayed, press the MENU button.• Battery is exhausted.• When flash lamp flashes, flash is charging.	29 3 21 52
Cannot capture 3D image.	In some shooting conditions, such as when the subject is dark or low in contrast, the second image may not be captured or the 3D image may not be saved.	 7







Problem	Cause/Solution	
Camera cannot focus.	<ul style="list-style-type: none"> Subject is too close. Try shooting using easy auto mode, Close-up scene mode, or macro mode. The intended subject is one with which autofocus does not perform well. Set AF assist in the setup menu to Auto. Turn camera off and then on again. 	34, 39, 57 28 88,  56 22
Images are blurred.	<ul style="list-style-type: none"> Use flash. Increase the ISO sensitivity value. Enable vibration reduction or motion detection. Use BSS (best shot selector). Use tripod and self-timer. 	51 49,  33 88,  54,  55 40, 49,  32 55
Streaks of light or partial discoloration are visible in the monitor.	Smear occurs when extremely bright light strikes the image sensor. When shooting with Continuous set to Multi-shot 16 and when recording movies, avoiding bright objects, such as the sun, reflections of the sun, and electric lights is recommended.	49,  32,  3
Bright specks appear in images captured with flash.	Flash is reflecting off particles in air. Lower the flash or set the flash mode setting to  (off).	5, 53
Flash does not fire.	<ul style="list-style-type: none"> The flash is lowered or the flash mode is set to  (off). Scene mode with which the flash does not fire is selected. On is selected for Blink proof in smart portrait menu. Another function that restricts flash is enabled. 	5, 51 60 46,  28 64

Problem	Cause/Solution	
Digital zoom cannot be used.	<ul style="list-style-type: none"> • Digital zoom cannot be used in the following situations. <ul style="list-style-type: none"> - When Portrait, Night portrait, Pet portrait, or 3D photography is selected for scene mode - When smart portrait mode is selected - When Continuous in the shooting menu is set to Multi-shot 16 	36, 37, 42, 43, 44, 49,  32
Image mode not available.	Another function that restricts the Image mode option is enabled.	64
No sound when shutter is released.	<ul style="list-style-type: none"> • Off is selected for Sound settings > Shutter sound in setup menu. No sound is heard with some shooting modes and settings, even when On is selected. • Do not block the speaker. 	88,  57 2
AF-assist illuminator does not light.	Off is selected for the AF assist option in the setup menu. AF-assist illuminator may not light depending on the current scene mode, even when Auto is selected.	88,  56
Images appear smeared.	Lens is dirty. Clean lens.	 7
Colors are unnatural.	White balance or hue is not adjusted properly.	39, 49,  29
Randomly spaced bright pixels ("noise") appear in image.	<p>The subject is dark, so shutter speed is too slow or ISO sensitivity is too high. Noise can be reduced by:</p> <ul style="list-style-type: none"> • Using flash. • Specifying a lower ISO sensitivity setting. 	51, 49,  33

Problem	Cause/Solution	
Images are too dark (underexposed).	<ul style="list-style-type: none"> The flash is lowered or the flash mode is set to  (off). Flash window is blocked. Subject is beyond flash range. Adjust exposure compensation. Increase ISO sensitivity. Subject is backlit. Select Backlighting scene mode, or raise the flash and set the flash mode to . 	51 23 51 59 49,  33 40, 51
Images are too bright (overexposed).	Adjust exposure compensation.	59
Unexpected results when flash set to  (auto with red-eye reduction).	When taking pictures with  (auto with red-eye reduction), or when taking pictures with Night portrait (either in easy auto mode or the Night portrait scene mode) and the fill flash with slow sync and red-eye reduction is used, red-eye reduction may be applied, in rare cases, to areas not affected by red-eye. Use auto mode or any scene mode other than Night portrait , and change the flash mode to any setting other than  (auto with red-eye reduction) and try taking a picture again.	37, 51
Skin tones are not softened.	<ul style="list-style-type: none"> In some shooting conditions, facial skin tones may not be smoothed. Use Skin softening in the playback menu for images containing four or more faces. 	45 70,  11
Saving images takes time.	It may take more time to save images in the following situations. <ul style="list-style-type: none"> When the noise reduction function is in operation, such as when shooting in a dark environment When the flash mode is set to  (auto with red-eye reduction) When the skin softening function is applied while shooting 	– 54 36, 37, 46
A ring-shaped belt or rainbow-colored stripe appears in the monitor or images.	When shooting with backlighting or when a very strong light source (such as sunlight) is in the frame, a ring-shaped belt or rainbow-colored stripe (ghosting) may occur. Change the position of the light source, or frame the picture so that the light source does not enter the frame and try again.	–

Playback Issues

Problem	Cause/Solution	
File cannot be played back.	<ul style="list-style-type: none"> File or folder was overwritten or renamed by computer or other make of camera. The COOLPIX L810 is not able to play back movies recorded with another make or model of digital camera. 	<p>–</p> <p>85</p>
Cannot zoom in on image.	<ul style="list-style-type: none"> Playback zoom cannot be used with movies, small pictures, or images that have been cropped to a size of 320 × 240 or smaller. This camera may not be able to zoom in on images captured with another make or model of digital camera. 3D images cannot be enlarged when the camera is connected via HDMI and they are played back in 3D. 	<p>–</p> <p>–</p> <p>43</p>
Cannot use D-Lighting, skin softening, small picture, or crop.	<ul style="list-style-type: none"> These options cannot be used with movies. Images captured at an Image mode setting of  4608×2592 and images captured using 3D photography cannot be edited, and the same editing feature cannot be applied multiple times. Camera is unable to edit images captured with other cameras. 	<p>–</p> <p>70, , 8, 9</p> <p>70, , 8, 9</p>
Cannot rotate image.	The camera cannot rotate images captured with another make or model of digital camera, or images captured with 3D photography .	43
Cannot edit movie.	<ul style="list-style-type: none"> Edited movies cannot be edited again. Movies cannot be trimmed so that they are less than 2 seconds long. Editing functions are not available when there is not enough free space in the internal memory or on the memory card, or when the battery level indicator is . 	 16

Problem	Cause/Solution	
Images are not displayed on TV.	<ul style="list-style-type: none"> • Video mode or HDMI is not correctly set in the TV settings setup menu. • Cables are connected to the HDMI mini connector (Type C) and to the USB connector and audio/video output simultaneously. • Memory card contains no images. Replace the memory card. Remove the memory card to play back images from the internal memory. 	89,  61 71, 76,  17,  20 13
Nikon Transfer 2 does not start when camera is connected.	<ul style="list-style-type: none"> • Camera is off. • Battery is exhausted. • USB cable is not correctly connected. • Camera is not recognized by the computer. • Confirm system requirements. • Computer is not set to start Nikon Transfer 2 automatically. For more information about Nikon Transfer 2, refer to help information contained in ViewNX 2. 	22 21 71, 76 – 73 76
Images to be printed are not displayed.	<ul style="list-style-type: none"> • Memory card contains no images. Replace the memory card. • Remove the memory card to print images from the internal memory. • Images captured in 3D photography scene mode cannot be printed. 	13 13 43
Cannot select paper size with camera.	<p>Paper size cannot be selected from the camera in the following situations, even when printing from a PictBridge-compatible printer. Use the printer to select paper size.</p> <ul style="list-style-type: none"> • The printer does not support the paper sizes specified by the camera. • The printer automatically selects the paper size. 	71,  23,  24 –

Specifications

Nikon COOLPIX L810 Digital Camera

Type	Compact digital camera
Effective pixels	16.1 million
Image sensor	¹ /2.3-in. type CCD; approx. 16.44 million total pixels
Lens	26× optical zoom, NIKKOR lens
Focal length	4.0-104.0mm (angle of view equivalent to that of 22.5-585 mm lens in 35mm [135] format)
f/-number	f/3.1-5.9
Construction	12 elements in 9 groups (1 ED lens element)
Digital zoom	Up to 4× (angle of view equivalent to that of approx. 2340 mm lens in 35mm [135] format)
Vibration reduction	Lens shift
Autofocus (AF)	Contrast-detect AF
Focus range (from lens)	<ul style="list-style-type: none">• [W]: Approx. 50 cm (1 ft 8 in.) to ∞, [T]: Approx. 1.5 m (5 ft) to ∞• Macro mode: Approx. 1 cm (0.4 in.) (when zoom is set to middle position) to ∞
Focus-area selection	Center, face detection
Monitor	7.5-cm (3-in.), approx. 921k-dot, wide viewing angle TFT LCD with anti-reflection coating and 5-level brightness adjustment
Frame coverage (shooting mode)	Approx. 98% horizontal and 98% vertical (compared to actual picture)
Frame coverage (playback mode)	Approx. 100% horizontal and 100% vertical (compared to actual picture)

Storage	
Media	Internal memory (approx. 50 MB), SD/SDHC/SDXC memory card
File system	DCF, Exif 2.3, DPOF, and MPF compliant
File formats	Still pictures: JPEG 3D images: MPO Movies: MOV (Video: H.264/MPEG-4 AVC, Audio: LPCM stereo)
Image size (pixels)	<ul style="list-style-type: none"> • 16M (High) [4608 × 3456★] • 16M [4608 × 3456] • 8M [3264 × 2448] • 4M [2272 × 1704] • 2M [1600 × 1200] • VGA [640 × 480] • 16:9 [4608 × 2592]
ISO sensitivity (Standard output sensitivity)	<ul style="list-style-type: none"> • ISO 80, 100, 200, 400, 800, 1600 • Auto (auto gain from ISO 80 to 1600)
Exposure	
Metering	256-segment matrix, center-weighted (digital zoom less than 2x), spot (digital zoom 2x or more)
Exposure control	Programmed auto exposure with motion detection and exposure compensation (–2.0 to +2.0 EV in steps of $\frac{1}{3}$ EV)
Shutter	
Speed	<ul style="list-style-type: none"> • $\frac{1}{1500}$ to 1 s • 4 s (Fireworks show scene mode)
Aperture	
Range	Electronically-controlled ND filter (–3.3 AV) selection 2 steps (f/3.1 and f/9.9 [W])
Self-timer	Approx. 10 s

Built-in flash	
Range (ISO sensitivity: Auto)	[W]: Approx. 0.5 to 5.0 m (1 ft 8 in. to 16 ft) [T]: Approx. 1.5 to 2.5 m (5 ft to 8 ft 2 in.)
Flash control	TTL auto flash with monitor preflashes
Interface	Hi-Speed USB
Data transfer protocol	MTP, PTP
Video output	Can be selected from NTSC and PAL
HDMI output	Can be selected from Auto, 480p, 720p, and 1080i
I/O terminal	Audio/video (A/V) output; digital I/O (USB) HDMI mini connector (Type C) (HDMI output), DC input connector
Supported languages	Arabic, Chinese (Simplified and Traditional), Czech, Danish, Dutch, English, Finnish, French, German, Greek, Hindi, Hungarian, Indonesian, Italian, Japanese, Korean, Norwegian, Polish, Portuguese (European and Brazilian), Romanian, Russian, Spanish, Swedish, Thai, Turkish, Ukrainian, Vietnamese
Power sources	<ul style="list-style-type: none"> • Four LR6/L40 (AA-size) alkaline batteries • Four FR6/L91 (AA-size) lithium batteries • Four EN-MH2 rechargeable Ni-MH batteries (available separately) • AC Adapter EH-67 (available separately)
Battery life	<p>Still pictures*:</p> <ul style="list-style-type: none"> • Approx. 300 shots when using alkaline batteries • Approx. 740 shots when using lithium batteries • Approx. 450 shots when using EN-MH2 batteries <p>Movies:</p> <ul style="list-style-type: none"> • Approx. 1 h 50 min when using alkaline batteries (HD 720p) • Approx. 5 h 15 min when using lithium batteries (HD 720p) • Approx. 3 h 10 min when using EN-MH2 batteries (HD 720p)
Tripod socket	1/4 (ISO 1222)
Dimensions (W × H × D)	Approx. 111.1 × 76.3 × 83.1 mm (4.4 × 3.1 × 3.3 in.) (excluding projections)
Weight	Approx. 430 g (15.2 oz) (including batteries and a memory card)

Operating environment

Temperature	0°C to 40°C (32°F to 104°F)
Humidity	Less than 85% (no condensation)

- Unless otherwise stated, all figures are for a camera with fully-charged LR6/L40 (AA-size) alkaline batteries operated at an ambient temperature of 25 °C (77 °F).
- * Based on Camera and Imaging Products Association (CIPA) standards for measuring the life of camera batteries. Measured at 23 (±2)°C (73 (±4)°F); zoom adjusted with each shot, flash fired with every other shot, image mode set to  **4608x3456**. Battery life may vary depending on shooting interval and length of time menus and images are displayed. Data for lithium batteries apply when using four commercially available FR6/L91 (AA-size) Energizer(R) Ultimate Lithium batteries. The included batteries are for trial use only.

 **Specifications**

- Nikon will not be held liable for any errors this manual may contain.
- The appearance of this product and its specifications are subject to change without notice.





















Supported Standards

- **DCF:** Design Rule for Camera File System is a standard widely used in the digital camera industry to ensure compatibility among different makes of camera.
- **DPOF:** Digital Print Order Format is an industry-wide standard that allows images to be printed from print orders saved on memory cards.
- **Exif version 2.3:** Exchangeable image file format (Exif) version 2.3 for digital still cameras is a standard that allows information saved with photographs to be used for optimal color reproduction when images are output from Exif-compliant printers.
- **PictBridge:** A standard developed cooperatively by the digital camera and printer industries, allowing photographs to be output directly to a printer without connecting the camera to a computer.













Index





































Refer to the Reference Manual CD for pages indicated with .

Symbols

		3
T (Tele).....			24
W (Wide).....			24
 Playback zoom.....			68
 Image thumbnail display.....			69
 Easy auto mode.....			34
 Scene mode.....			35
 Smart portrait mode.....			44
 Auto mode.....			48
 Playback mode.....			29
 Setup menu.....			88
 Apply selection button.....			3
 Shooting mode button.....			3
 Movie-record button.....			3
 Playback button.....			3, 29
 Delete button.....			3, 31
MENU button.....			3, 46, 49, 70, 83, 88
 (flash pop-up) button.....			5, 51
 Flash mode.....			51
 Self-timer.....			55
 Macro mode.....			57
 Exposure compensation.....			59
 Help.....			35

Numerics

3D images.....	43,  , 	69	
3D photography 3D		43, 	
A			
AC adapter.....	12, 	70	
AF assist.....	88, 	56	
AF-assist illuminator.....		2	
Alkaline batteries.....		11	
Aperture value.....		27	
Audio/video cable... ..	71, 72,  , 	70	
Audio/video-in jack.....	72, 	17	
Auto flash.....		53	
Auto mode.....		48	
Auto off.....	22, 88, 	58	
Autofocus.....		28, 58	
Autofocus mode.....	83, 	45	
B			
Backlighting 	40	
Battery.....		10, 19	
Battery chamber.....		3	
Battery charger.....			70
Battery level.....			21
Battery type.....	89, 		68
Battery-chamber/memory card slot cover.....			3, 13

Beach 	38	DPOF 	20
Best shot selector.....	40, 	DPOF print.....	 26
Black and white copy 	40	DSCN.....	 69
Black-and-white.....	49, 	Dusk/dawn 	38
Blink proof.....	46, 	E	
Blink warning.....	89, 	Easy auto mode.....	34
Brightness.....	 51	Editing movies.....	 15
BSS.....	40, 	EN-MH2.....	 70,  4
Built-in microphone.....	2	Exposure compensation.....	59
Button sound.....	 57	Extension.....	 69
C		Eye-Fi upload.....	89,  64
Calendar display.....	69	Eyelet for camera strap.....	2
Close-up 	39	E	
Color options.....	49, 	Face detection.....	65
Compression ratio.....	62	File name.....	 69
Computer.....	72, 76	Fill flash.....	53
Connector cover.....	2	Fireworks show 	40
Continuous.....	49, 	Firmware version.....	89,  68
Copying images.....	70, 	Flash.....	2, 51
Crop.....	68, 	Flash lamp.....	3, 52
Cyanotype.....	49, 	Flash mode.....	51, 53
D		Flash off.....	53
Date and time.....	16, 88, 	Focus.....	26, 65
Date format.....	17, 	Focus indicator.....	7
Daylight saving time.....	17, 	Focus lock.....	66
DC input connector.....	2	Folder name.....	 69
Delete.....	31	Food 	39
Digital zoom.....	25	Format internal memory.....	89,  59
Direct print.....	72, 	Format memory cards.....	14, 89,  59
D-Lighting.....	70, 	Formatting.....	14, 89,  59

FSCN.....	69	Monitor settings.....	88, 51
Full-frame playback.....	29	Motion detection.....	88, 55
Full-time AF.....	83, 45	MOV.....	69
H		Movie length.....	82
HDMI.....	61	Movie menu.....	83
HDMI 3D output.....	61	Movie options.....	83, 44
HDMI cable.....	72, 17	Movie playback.....	84
HDMI device control.....	61	Movie recording.....	80
HDMI mini connector.....	2	Movie-record button.....	3
Help.....	35	MPO.....	69
I		Multi selector.....	3
Identifier.....	69	Multi-shot 16.....	32
Image copy.....	70, 42	Museum	40
Image mode.....	62	N	
Imprinting date and time.....	19, 53	Night landscape	39
Internal memory.....	14	Night portrait	37
ISO sensitivity.....	49, 33	Nikon Transfer 2.....	73, 75, 77
J		Number of exposures remaining...	21, 63
JPG.....	69	Q	
L		Optical zoom.....	24
Landscape	36	Optional accessories.....	70
Language.....	89, 60	P	
Lens.....	2, 16	Panorama assist	41, 62
Lithium batteries.....	11	Panorama Maker 6.....	41, 75, 64
M		Paper size.....	23, 24
Macro mode.....	57	Party/indoor	37
Memory capacity.....	21	Pet portrait auto release.....	42
Memory card.....	13	Pet portrait	42
Memory card slot.....	3, 13	Photo info.....	51
Monitor.....	3, 6, 7	PictBridge.....	72, 19, 20

Playback.....	29, 84	Self-timer lamp.....	2, 56
Playback button.....	3	Sepia.....	49, 34
Playback menu.....	70, 35	Setup menu.....	88
Playback mode.....	29	Shooting.....	20, 23, 26
Playback zoom.....	68	Shooting menu.....	49, 29
Portrait	36	Shooting mode button.....	3
Power.....	20, 22	Shutter sound.....	57
Power switch.....	20, 22	Shutter speed.....	27
Power switch/power-on lamp.....	2	Shutter-release button.....	2, 26
Power-on lamp.....	20, 22	Side zoom control.....	2, 24
Preset manual.....	30	Single.....	49, 32
Pressing halfway.....	27	Single AF.....	83, 45
Print.....	70, 72, 22, 24, 35	Skin softening.....	46, 70, 11, 27
Print date.....	19, 88, 53	Sleep mode.....	58
Print order.....	70, 35	Slide show.....	70, 38
Print order date option... 19, 36, 37		Slow sync.....	53
Printer.....	72, 19	Small picture.....	70, 12
Protect.....	70, 39	Smart portrait menu.....	46, 27
R		Smart portrait mode.....	44
Rechargeable battery.....	70	Smile timer.....	46, 28
Rechargeable nickel-metal hydride batteries.....	11	Snow	38
Recording movies.....	80	Sound settings.....	88, 57
Red-eye reduction.....	53, 54	Speaker.....	2
Reset all.....	89, 65	Sports	37
Rotate image.....	70, 41	SSCN.....	69
RSCN.....	69	Standard color.....	49, 34
S		Strap.....	4
Scene mode.....	35, 36	Sunset	38
Self-timer.....	55	I	
		Thumbnail display.....	69

Time difference	50
Time zone	17, 47, 50
Time zone and date.....	16, 88, 47
Tripod socket	3, 18
TV	72, 17
TV settings	89, 61

U

USB cable	71, 76, 21, 70
USB connector and audio/video output	2, 71, 76, 17, 19

V

Vibration reduction.....	88, 54
Video mode	61
ViewNX 2.....	73, 75
Vivid color	49, 34
Volume	85

W

Welcome screen	88, 46
White balance	49, 29
Wind noise reduction.....	83, 45

Z

Zoom	24
Zoom control	2, 24
Zoom in.....	24
Zoom out.....	24

Nikon

No reproduction in any form of this manual, in whole or in part (except for brief quotation in critical articles or reviews), may be made without written authorization from NIKON CORPORATION.

NIKON CORPORATION

© 2012 Nikon Corporation

Printed in Hong Kong



CT2A01(11)
6MM25811-01