

Nikon

DIGITAL CAMERA
COOLPIX S100

Reference Manual

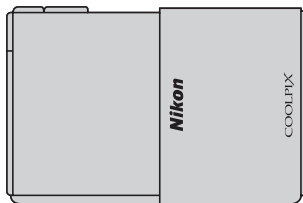

En

Trademark Information

- Microsoft, Windows and Windows Vista are either registered trademarks or trademarks of Microsoft Corporation in the United States and/or other countries.
- Macintosh, Mac OS, and QuickTime are trademarks of Apple Inc., registered in the U.S. and other countries. The iFrame logo and the iFrame symbol are trademarks of Apple Inc.
- Adobe and Acrobat are registered trademarks of Adobe Systems Inc.
- SDXC, SDHC, and SD Logos are trademarks of SD-3C, LLC.
- PictBridge is a trademark.
- HDMI, **HDMI** logo, and High-Definition Multimedia Interface are trademarks or registered trademarks of HDMI Licensing LLC.
- All other trade names mentioned in this manual or the other documentation provided with your Nikon product are trademarks or registered trademarks of their respective holders.

AVC Patent Portfolio License

This product is licensed under the AVC Patent Portfolio License for the personal and non-commercial use of a consumer to (i) encode video in compliance with the AVC standard ("AVC video") and/or (ii) decode AVC video that was encoded by a consumer engaged in a personal and non-commercial activity and/or was obtained from a video provider licensed to provide AVC video. No license is granted or shall be implied for any other use. Additional information may be obtained from MPEG LA, L.L.C.

See <http://www.mpegla.com>.

Introduction

Parts of the Camera and Basic Operations

Basic Steps for Shooting and Playback

Shooting Features

Playback Features

Recording and Playing Back Movies

General Camera Setup

Reference Section

Technical Notes and Index

Read This First

Thank you for purchasing the Nikon COOLPIX S100 digital camera. Before using the camera, please read the information in "For Your Safety" (📖 vi) and familiarize yourself with the information provided in this manual. After reading, please keep this manual handy and refer to it to enhance your enjoyment of your new camera.

Confirming the Package Contents

In the event that any items are missing, please contact the store where you purchased the camera.



COOLPIX S100
Digital Camera



Camera Strap



Rechargeable Li-ion Battery
EN-EL19
(with battery case)

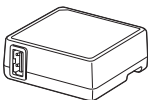

Charging AC Adapter
EH-69P*

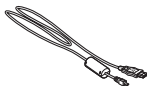

USB Cable UC-E6



Audio Video Cable
EG-CP16



ViewNX 2 Installer CD



Reference Manual CD

- Warranty

* A plug adapter is included if the camera was purchased in a country or region that requires a plug adapter. The shape of the plug adapter varies with the country or region of purchase (📖 16).

NOTE: A memory card is not included with the camera.







About This Manual

If you want to start using the camera right away, see “Basic Steps for Shooting and Playback” (📖 13).

To learn about the parts of the camera and basic operations, see “Parts of the Camera and Basic Operations” (📖 1).

Other Information

- Symbols and conventions

Symbol	Description
	This icon indicates cautions and information that should be read before using the camera.
	This icon marks notes, information that should be read before using the camera.
 /  / 	These icons indicate other pages containing relevant information;  : “Reference Section”,  : “Technical Notes and Index.”

- SD, SDHC, and SDXC memory cards are referred to as “memory cards” in this manual.
- The setting at the time of purchase is referred to as the “default setting.”
- The names of menu items displayed in the camera monitor, and the names of buttons or messages displayed on a computer monitor appear in bold.
- In this manual, images are sometimes omitted from monitor display samples so that monitor indicators can be more clearly shown.
- Illustrations and monitor content shown in this manual may differ from the actual product.

Information and Precautions

Life-Long Learning

As part of Nikon's "Life-Long Learning" commitment to ongoing product support and education, continually updated information is available online at the following sites:

- For users in the U.S.A.: <http://www.nikonusa.com/>
- For users in Europe and Africa: <http://www.europe-nikon.com/support/>
- For users in Asia, Oceania, and the Middle East: <http://www.nikon-asia.com/>

Visit these sites to keep up-to-date with the latest product information, tips, answers to frequently asked questions (FAQs), and general advice on digital imaging and photography. Additional information may be available from the Nikon representative in your area. Visit the site below for contact information.

<http://imaging.nikon.com/>

Use Only Nikon Brand Electronic Accessories

Nikon COOLPIX cameras are designed to the highest standards and include complex electronic circuitry. Only Nikon brand electronic accessories (including battery charger, batteries, Charging AC Adapter, and AC adapters) certified by Nikon specifically for use with this Nikon digital camera are engineered and proven to operate within the operational and safety requirements of this electronic circuitry.

THE USE OF NON-NIKON ELECTRONIC ACCESSORIES COULD DAMAGE THE CAMERA AND MAY VOID YOUR NIKON WARRANTY.

The use of third-party rechargeable Li-ion batteries not bearing the Nikon holographic seal could interfere with normal operation of the camera or result in the batteries overheating, igniting, rupturing, or leaking.

For more information about Nikon brand accessories, contact a local authorized Nikon dealer.



Holographic seal:

Identifies this device as an authentic Nikon product.

Before Taking Important Pictures

Before taking pictures on important occasions (such as at weddings or before taking the camera on a trip), take a test shot to ensure that the camera is functioning normally. Nikon will not be held liable for damages or lost profits that may result from product malfunction.

About the Manuals

- No part of the documentation included with this product may be reproduced, transmitted, transcribed, stored in a retrieval system, or translated into any language in any form, by any means, without Nikon's prior written permission.
- Nikon reserves the right to change the specifications of the hardware and software described in the documentation at any time and without prior notice.
- Nikon will not be held liable for any damages resulting from the use of this product.
- While every effort was made to ensure that the information in the documentation is accurate and complete, we would appreciate it were you to bring any errors or omissions to the attention of the Nikon representative in your area (address provided separately).

Notice Concerning Prohibition of Copying or Reproduction

Note that simply being in possession of material that was digitally copied or reproduced by means of a scanner, digital camera or other device may be punishable by law.

- **Items prohibited by law from being copied or reproduced**

Do not copy or reproduce paper money, coins, securities, government bonds or local government bonds, even if such copies or reproductions are stamped "Sample." The copying or reproduction of paper money, coins, or securities which are circulated in a foreign country is prohibited. Unless the prior permission of the government was obtained, the copying or reproduction of unused postage stamps or post cards issued by the government is prohibited. The copying or reproduction of stamps issued by the government and of certified documents stipulated by law is prohibited.

- **Cautions on certain copies and reproductions**

The government has issued cautions on copies or reproductions of securities issued by private companies (shares, bills, checks, gift certificates, etc.), commuter passes, or coupon tickets, except when a minimum of necessary copies are to be provided for business use by a company. Also, do not copy or reproduce passports issued by the government, licenses issued by public agencies and private groups, ID cards and tickets, such as passes and meal coupons.

- **Comply with copyright notices**

The copying or reproduction of copyrighted creative works such as books, music, paintings, woodcut prints, maps, drawings, movies, and photographs is governed by national and international copyright laws. Do not use this product for the purpose of making illegal copies or to infringe copyright laws.

Disposing of Data Storage Devices

Please note that deleting images or formatting data storage devices such as memory cards or built-in camera memory does not completely erase the original image data. Deleted files can sometimes be recovered from discarded storage devices using commercially available software, potentially resulting in the malicious use of personal image data. Ensuring the privacy of such data is the user's responsibility.

Before discarding a data storage device or transferring ownership to another person, erase all data using commercial deletion software, or format the device and then completely refill it with images containing no private information (for example, pictures of empty sky). Be sure to also replace any pictures selected for the **Select an image** option in the **Welcome screen** setting (🔑 79). Care should be taken to avoid injury or damage to property when physically destroying data storage devices.

For Your Safety

To prevent damage to your Nikon product or injury to yourself or to others, read the following safety precautions in their entirety before using this equipment. Keep these safety instructions where all those who use the product will read them. The consequences that could result from failure to observe the precautions listed in this section are indicated by the following symbol:



This icon marks warnings, information that should be read before using this Nikon product, to prevent possible injury.

WARNINGS

Turn off in the event of malfunction

Should you notice smoke or an unusual smell coming from the camera or Charging AC Adapter, unplug the Charging AC Adapter and remove the battery immediately, taking care to avoid burns. Continued operation could result in injury. After removing or disconnecting the power source, take the equipment to a Nikon-authorized service representative for inspection.

Do not disassemble

Touching the internal parts of the camera or Charging AC Adapter could result in injury. Repairs should be performed only by qualified technicians. Should the camera or Charging AC Adapter break open as the result of a fall or other accident, take the product to a Nikon-authorized service representative for inspection, after unplugging the product and/or removing the battery.

Do not use the camera or Charging AC Adapter in the presence of flammable gas

Do not use electronic equipment in the presence of flammable gas, as this could result in explosion or fire.

Handle the camera strap with care

Never place the strap around the neck of an infant or child.

Keep out of reach of children

Particular care should be taken to prevent infants from putting the battery or other small parts into their mouths.

Do not remain in contact with the camera, battery charger, or AC adapter for extended periods while the devices are on or in use.

Parts of the devices become hot. Leaving the devices in direct contact with the skin for extended periods may result in low-temperature burns.

Observe caution when handling the battery

The battery may leak, overheat or explode if improperly handled. Observe the following precautions when handling the battery for use in this product:

- Before replacing the battery, turn the product off. If you are using the Charging AC Adapter/AC adapter, be sure it is unplugged.
- Use only a Rechargeable Li-ion Battery EN-EL19 (included). Charge the battery by using a camera that supports battery charging. To perform this operation, use either Charging AC Adapter EH-69P (included) or the **Charge by computer** function. The Battery Charger MH-66 (available separately) is also available to charge the battery without using a camera.
- When inserting the battery, do not attempt to insert it upside down or backwards.
- Do not short or disassemble the battery or attempt to remove or break the battery insulation or casing.
- Do not expose the battery to flame or to excessive heat.
- Do not immerse in or expose to water.
- Put the battery in the battery case before transporting it. Do not transport or store with metal objects such as necklaces or hairpins.

- The battery is prone to leakage when fully discharged. To avoid damage to the product, be sure to remove the battery when no charge remains.
- Discontinue use immediately should you notice any change in the battery, such as discoloration or deformation.
- If liquid from the damaged battery comes in contact with clothing or skin, rinse immediately with plenty of water.

Observe the following precautions when handling the Charging AC Adapter

- Keep dry. Failure to observe this precaution could result in fire or electric shock.
- Dust on or near the metal parts of the plug should be removed with a dry cloth. Continued use could result in fire.
- Do not handle the plug or go near the Charging AC Adapter during lightning storms. Failure to observe this precaution could result in electric shock.
- Do not damage, modify, forcibly tug or bend the USB cable, place it under heavy objects, or expose it to heat or flames. Should the insulation be damaged and the wires become exposed, take it to a Nikon-authorized service representative for inspection. Failure to observe these precautions could result in fire or electric shock.

- Do not handle the plug or Charging AC Adapter with wet hands. Failure to observe this precaution could result in electric shock.
- Do not use with travel converters or adapters designed to convert from one voltage to another or with DC-to-AC inverters. Failure to observe this precaution could damage the product or cause overheating or fire.

 **Use appropriate cables**

When connecting cables to the input and output jacks, use only the cables provided or sold by Nikon for the purpose, to maintain compliance with product regulations.

 **Handle moving parts with care**

Be careful that your fingers or other objects are not pinched by the slide cover or other moving parts.

 **CD-ROMs**

The CD-ROMs included with this device should not be played back on audio CD equipment. Playing CD-ROMs on an audio CD player could cause hearing loss or damage the equipment.

 **Observe caution when using the flash**

Using the flash close to your subject's eyes could cause temporary visual impairment. Particular care should be observed if photographing infants, when the flash should be no less than one meter (3 ft 4 in.) from the subject.

 **Do not operate the flash with the flash window touching a person or object**

Failure to observe this precaution could result in burns or fire.

 **Do not apply pressure to the monitor**

Should the monitor break, care should be taken to avoid injury caused by broken glass.

 **Turn the power off when using inside an airplane or the hospital**

Turn the power off while inside the airplane during take off or landing. Follow the instructions of the hospital when using while in a hospital. The electromagnetic waves given out by this camera may disrupt the electronic systems of the airplane or the instruments of the hospital.

 **3D Images**

Do not continuously view 3D images recorded with this device for extended periods, whether on a television, monitor, or other display.

In the case of children whose visual systems are still maturing, consult a pediatrician or ophthalmologist prior to use and follow their instructions. Prolonged viewing of 3D images may cause eye strain, nausea, or discomfort. Cease use should any of these symptoms occur and consult a physician if necessary.

Notices

Notices for Customers in the U.S.A.

IMPORTANT SAFETY INSTRUCTIONS— SAVE THESE INSTRUCTIONS.

DANGER - TO REDUCE THE RISK OF FIRE OR ELECTRIC SHOCK, CAREFULLY FOLLOW THESE INSTRUCTIONS

For connection to a supply not in the U.S.A., use an attachment plug adapter of the proper configuration for the power outlet if needed.

The power supply unit is intended to be correctly orientated in a vertical or floor mount position.

Federal Communications Commission (FCC) Radio Frequency Interference Statement

This equipment has been tested and found to comply with the limits for a Class B digital device, pursuant to Part 15 of the FCC rules. These limits are designed to provide reasonable protection against harmful interference in a residential installation. This equipment generates, uses, and can radiate radio frequency energy and, if not installed and used in accordance with the instructions, may cause harmful interference to radio communications. However, there is no guarantee that interference will not occur in a particular installation. If this equipment does cause harmful interference to radio or television reception, which can be determined by turning the equipment off and on, the user is encouraged to try to correct the interference by one or more of the following measures:

- Reorient or relocate the receiving antenna.

- Increase the separation between the equipment and receiver.
- Connect the equipment into an outlet on a circuit different from that to which the receiver is connected.
- Consult the dealer or an experienced radio/television technician for help.



Nikon
COOLPIX S100

CAUTIONS

Modifications

The FCC requires the user to be notified that any changes or modifications made to this device that are not expressly approved by Nikon Corporation may void the user's authority to operate the equipment.

Interface Cables

Use the interface cables sold or provided by Nikon for your equipment. Using other interface cables may exceed the limits of Class B Part 15 of the FCC rules.

Notice for customers in the State of California

WARNING

Handling the cord on this product will expose you to lead, a chemical known to the State of California to cause birth defects or other reproductive harm.

Wash hands after handling.

Nikon Inc.,
1300 Walt Whitman Road
Melville, New York 11747-3064
USA

Tel: 631-547-4200

Notice for customers in Canada**CAUTION**

This Class B digital apparatus complies with Canadian ICES-003.

ATTENTION

Cet appareil numérique de la classe B est conforme à la norme NMB-003 du Canada.

Notices for customers in Europe**CAUTIONS****RISK OF EXPLOSION IF BATTERY IS REPLACED BY AN INCORRECT TYPE.****DISPOSE OF USED BATTERIES ACCORDING TO THE INSTRUCTIONS.**

This symbol indicates that this product is to be collected separately.



The following apply only to users in European countries:

- This product is designated for separate collection at an appropriate collection point. Do not dispose of as household waste.
- For more information, contact the retailer or the local authorities in charge of waste management.

This symbol on the battery indicates that the battery is to be collected separately.



The following apply only to users in European countries:

- All batteries, whether marked with this symbol or not, are designated for separate collection at an









appropriate collection point. Do not dispose of as household waste.



















- For more information, contact the retailer or the local authorities in charge of waste management.









Table of Contents









Introduction	ii
Read This First	ii
Confirming the Package Contents	ii
About This Manual.....	iii
Information and Precautions.....	iv
For Your Safety.....	vi
WARNINGS.....	vi
Notices	ix
<hr/>	
Parts of the Camera and Basic Operations.....	1
Parts of the Camera.....	2
The Camera Body	2
Pressing the Shutter-release Button	2
Attaching the Camera Strap.....	3
Operating the Touch Panel.....	4
Tapping.....	4
Dragging.....	4
Dragging and Dropping.....	4
Spreading/pinching.....	5
Indicators and Operations of the Monitor/Touch Panel.....	6
Shooting Mode (Information Indicators).....	6
Shooting Mode (Operation Controls).....	7
Playback Mode (Information Display).....	8
Playback Mode (Operation Controls).....	9
Switching Between Shooting Mode and Playback Mode	10
Using Menus (MENU Tab).....	11
<hr/>	
Basic Steps for Shooting and Playback.....	13
Preparation 1 Insert the Battery.....	14
Preparation 2 Charge the Battery	16
Preparation 3 Insert a Memory Card.....	18
Internal Memory and Memory Cards.....	19
Approved Memory Cards	19
Step 1 Turn the Camera On.....	20
Turning the Camera On and Off.....	21
Setting Display Language, Date and Time	22
Step 2 Select a Shooting Mode.....	24
Available Shooting Modes.....	25
Step 3 Frame a Picture	26
Using the Zoom.....	27
Step 4 Focus and Shoot.....	28

Step 5 Play Back Pictures	30
Changing How Pictures Are Displayed	31
Step 6 Delete Unwanted Pictures	32
<hr/>	
Shooting Features	35
📷 (Easy Auto) Mode	36
Changing the 📷 (Easy Auto) Mode Settings	36
📷 (Auto) Mode	37
Adjusting the 📷 (Auto) Mode Settings	37
Shooting Menu Options in 📷 (Auto) Mode	38
Scene Mode (Shooting Suited to the Scene)	40
Changing the Scene Mode Settings	41
Selecting a Scene Mode to Take Pictures (Features)	42
Smart Portrait Mode (Shooting Smiling Faces)	50
Changing the Smart Portrait Mode Settings	52
Smart Portrait Menu Options	52
Basic Shooting Settings	53
Functions Available for Each Shooting Mode	53
Using the Flash (Flash Modes)	54
Using the Self-timer	56
Using Macro Mode	58
Adjusting Brightness (Exposure Compensation)	59
Default Settings	60
🔍 Changing the Image Size (Image Mode)	62
Image Mode Settings (Image Size and Quality)	62
Features That Cannot Be Applied Simultaneously	64
Face Detection	65
Skin Softening	67
<hr/>	
Playback Features	69
Selecting Certain Types of Pictures for Playback	70
Available Playback Modes	70
Switching Between Playback Modes	71
Setting the Picture Rating	72
Features Available in Playback Mode (Playback Menu)	73
Connecting the Camera to a Television, Computer, or Printer	75
Using ViewNX 2	76
Installing ViewNX 2	76
Transferring Images to the Computer	78
Viewing Images	79
Retouching Photographs	80

Editing Movies	80
Printing Images	80
Recording and Playing Back Movies.....	81
Recording Movies	82
Changing Movie Recording Settings	85
Movie Menu Options.....	85
Movie Playback.....	86
General Camera Setup.....	87
The Setup Menu	88
Reference Section	81
Using the Draw Option	82
Using Easy Panorama (Shooting and Playback)	83
Shooting with Easy Panorama.....	83
Playing Pictures Taken with Easy Panorama (Scroll Playback).....	85
Using Panorama Assist.....	86
Taking 3D Pictures.....	88
Favorite Pictures Mode	10
Adding Pictures to Albums	10
Viewing Pictures in an Album.....	11
Removing Pictures from Albums.....	12
Changing Icons Assigned to Albums.....	13
Auto Sort Mode	14
List by Date Mode	16
Playing and Deleting Pictures Taken Continuously (Sequence).....	17
Playing Pictures in a Sequence	17
Deleting Pictures in a Sequence	19
Editing Pictures (Still Pictures).....	20
Editing Functions.....	20
 Paint.....	22
 Quick Retouch: Enhancing Contrast and Saturation.....	25
 D-Lighting: Enhancing Brightness and Contrast	26
 Stretch: Stretching Pictures.....	27
 Perspective Control: Adjust a Sense of Perspective.....	28
 Filter Effects (Digital Filters)	29
 Glamour Retouch: Softening Skin and Making Up Smaller Faces with Larger Eyes	31
 Small Picture: Making Smaller Pictures.....	33
 Crop: Creating a Cropped Copy	34

Connecting the Camera to a TV (Playback on a TV)	0035
Connecting the Camera to a Printer	0038
Connecting the Camera to a Printer	0039
Printing Pictures One at a Time	0040
Printing Multiple Pictures	0041
Recording Movies in Slow Motion and Fast Motion (HS Movie).....	0044
Editing Movies.....	0047
The Shooting Menu (for  (Auto) Mode)	0049
 Touch Shooting	0049
 ISO Sensitivity	0056
 Continuous	0057
 White Balance (Adjusting Hue)	0059
The Smart Portrait Menu	0061
 Skin Softening	0061
 Blink Proof	0061
 Smile Timer	0061
The Playback Menu	0062
 Slide Shows	0062
 Protect	0064
 Print Order (Creating a DPOF Print Order).....	0066
 Rotate Image.....	0070
 Voice Memo.....	0071
 Copy (Copy Between Internal Memory and Memory Card)	0073
 Choose Key Picture	0074
The Movie Menu.....	0075
 Movie Options.....	0075
 Open with HS Footage	0077
 Autofocus Mode	0077
 Wind Noise Reduction	0078
The Setup Menu	0079
Welcome Screen.....	0079
Time Zone and Date.....	0080
Monitor Settings.....	0083
Print Date (Imprinting Date and Time).....	0084
Vibration Reduction	0085
AF Assist.....	0086
Digital Zoom	0086
Sound Settings.....	0087
Auto Off	0088
Format Memory/Format Card	0089
Language.....	0090
TV Settings	0091

Charge by Computer	 92
Blink Warning	 93
Sequence Display Options	 94
Reset All	 95
Firmware Version	 97
File and Folder Names	 98
Optional Accessories	 99
Error Messages	 100

Technical Notes and Index	 1
Maximizing Camera Life and Performance	 2
Memory Cards	 4
Cleaning	 5
Storage	 5
Troubleshooting	 7
Specifications	 14
Supported Standards	 17
Index	 18



A series of horizontal dashed lines spanning the width of the page, intended for handwriting practice. There are 15 lines in total, starting from the top right and extending to the bottom left.



Parts of the Camera and Basic Operations

This chapter describes the parts of the camera and also explains how to use basic camera features.

Parts of the Camera	2
The Camera Body	2
Pressing the Shutter-release Button	2
Attaching the Camera Strap	3
Operating the Touch Panel	4
Tapping	4
Dragging	4
Dragging and Dropping	4
Spreading/pinching	5
Indicators and Operations of the Monitor/Touch Panel	6
Shooting Mode (Information Indicators)	6
Shooting Mode (Operation Controls)	7
Playback Mode (Information Display)	8
Playback Mode (Operation Controls)	9
Switching Between Shooting Mode and Playback Mode	10
Using Menus (MENU Tab)	11

➔ If you want to start using the camera right away, see “Basic Steps for Shooting and Playback” (📖 13).

Parts of the Camera

The Camera Body

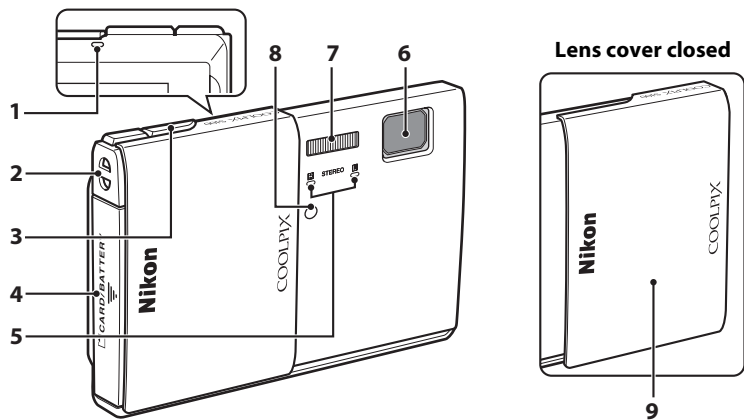

1	Power-on lamp..... 17, 21, 93	6	Lens
2	Eyelet for camera strap..... 3	7	Flash..... 54
3	Shutter-release button..... 2, 28	8	Self-timer lamp 51, 56
4	Battery-chamber/ memory card slot cover 14, 18	9	AF-assist illuminator..... 29, 89
5	Microphone (stereo)..... 82, 71		Slide cover (power switch) 21

Pressing the Shutter-release Button

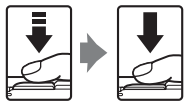

Pressing halfway: Press the shutter-release button slightly until you feel resistance to set and lock focus and exposure.

Pressing all the way: Press the shutter-release button all the way down to release the shutter.

- You can also release the shutter by tapping the monitor. See " Touch shooting" (38) for more information.

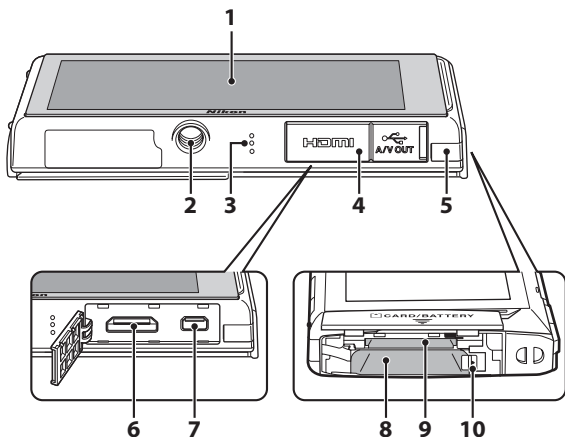

1	OLED monitor (monitor)*/ touch panel.....	4
2	Tripod socket	
3	Speaker	86
4	Connector cover	16, 75
5	Power connector cover (for connection with optional AC Adapter)	99

6	HDMI mini connector (Type C)	75
7	USB/audio/video output connector	16, 75
8	Battery chamber.....	14
9	Memory card slot.....	18
10	Battery latch.....	14, 15

* Referred to simply as the "monitor" in this manual.

Attaching the Camera Strap

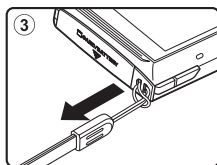
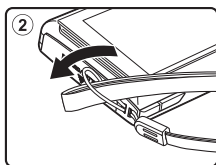
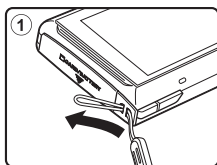

Operating the Touch Panel

The monitor on the COOLPIX S100 is a touch panel display operated by touch. Use the method described below.

Tapping

Tap the touch panel.

Use this operation to:

Select icons

Select pictures in thumbnail playback mode (📖 31)

Perform touch shutter, touch AF/AE, or subject tracking operations (📖 38)

Display the menu options by tapping the **MENU** tab during shooting or playback (📖 11)

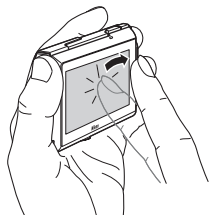

Dragging

Drag your finger across the touch panel and remove it from the touch panel.

Use this operation to:

Scroll through pictures in full-frame playback mode (📖 30)

Move the visible portion of a picture enlarged with playback zoom (📖 31)

Move sliders such as when adjusting exposure compensation (📖 59)

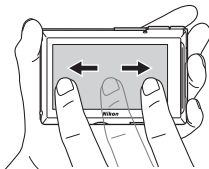

Dragging and Dropping

Place your finger on the touch panel, drag it to the desired location (①), and remove it from the touch panel (②).

Use this operation to:

Apply the rating setting (📖 72)

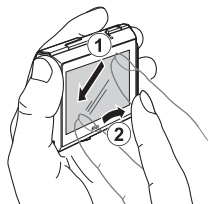

Spreading/pinching

Spread two fingers apart/pinch two fingers together.

Use this operation to:

Zoom in/out on a picture (📖 31) in playback mode

Switch to thumbnail playback mode from full-frame playback mode (📖 31)

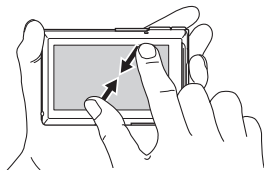
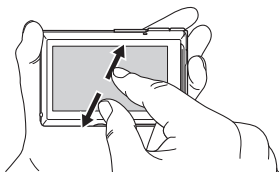

✔ Notes on the Touch Panel

- This camera utilizes a static touch panel. Therefore, it may not respond when touched with fingernails or gloved fingers.
- Do not press on the touch panel with pointed objects.
- Do not apply unnecessary pressure to the touch panel.
- The touch panel may not respond to touch if a commercially available protecting film is applied.

✔ Notes on Touch Panel Operations

- The camera may not respond if your finger is left in one place too long.
- The camera may not respond if the followings are made.
 - Bounce your finger off the display
 - Drag your finger over too short a distance
 - Stroke the display too lightly
 - Move your finger too quickly
 - Both fingers are not moved simultaneously when spreading or pinching
- The camera may not respond if something else is touching the touch panel when your finger touches it.

Indicators and Operations of the Monitor/Touch Panel

Shooting Mode (Information Indicators)

- The information displayed on the monitor varies with the camera settings or status.

By default, the information is displayed when the camera is turned on and when the camera is being operated, and some of the information is hidden after a few seconds (when **Photo info** is set to **Auto info** in **Monitor settings** (88)).

Tap **[DISP.]** to display it again.

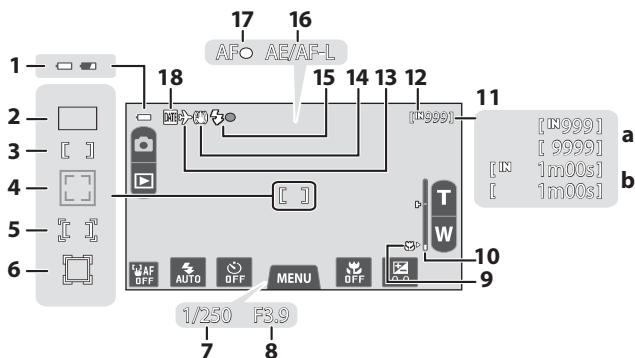

Parts of the Camera and Basic Operations

1	Battery level indicator.....	20
2	Focus area (auto).....	28
3	Focus area (center)	
4	Focus area (face or pet detection)	28, 48, 65
5	Focus area (touch AF/AE).....	38, 39
6	Focus area (subject tracking).....	38
7	Shutter speed.....	28
8	Aperture.....	28
9	Macro mode.....	58
10	Zoom indicator.....	27, 58

11	a Number of exposures remaining (still pictures).....	20
	b Movie recording time remaining	84
12	Internal memory indicator.....	20, 82
	Travel destination.....	88
13	Date not set.....	23
14	Vibration reduction.....	89
15	Flash indicator.....	54
16	AE/AF-L indicator.....	7, 8
17	Focus indicator.....	28
18	Print date.....	23, 88

Shooting Mode (Operation Controls)

Tap the following icons to change the camera mode or settings.

- Tap the **MENU** tab to display the menu options and shooting settings can be changed (11).
- The controls available and the setting status displayed vary depending upon the shooting mode and the current camera settings.

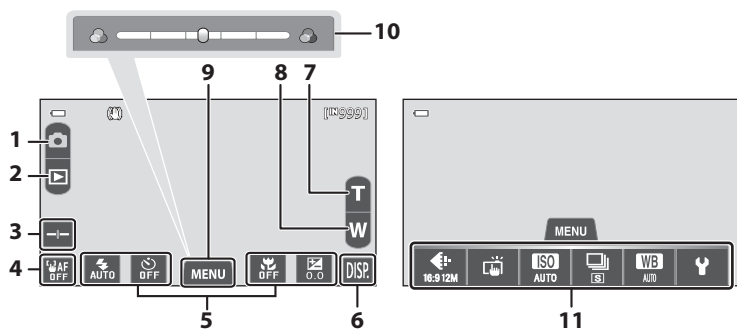

1	Shooting mode ¹ 10, 24, 36, 37, 40, 50, 82	6	Information redisplay..... 11
2	Switch to playback mode 10, 30	7	Telephoto zoom..... 27
3	Slider display (scene effect adjustment) 41	8	Wide-angle zoom..... 27
4	Touch AF/AE cancellation..... 38, 39	9	MENU tab 11
5	Basic shooting settings ² 54, 56, 58, 59	10	Scene effect adjustment slider 41
		11	Menu options ² 11

¹ Icons displayed vary with current shooting mode.

² Each icon also indicates the current setting.

Playback Mode (Information Display)

- The information displayed on the monitor varies with the camera settings or status.

By default, the information is displayed when the camera is turned on and when the camera is being operated, and is hidden after a few seconds (when **Photo info** is set to **Auto info** in **Monitor settings** (88)).

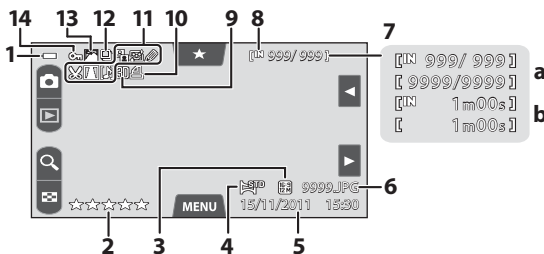

Parts of the Camera and Basic Operations

1	Battery level indicator.....	20
2	Rating indicator.....	72
3	Image mode ¹	62
3	Movie options ¹	85
4	Easy panorama icon.....	47
5	Date/time of recording.....	22
6	File number and type.....	98
7	a Current frame number/ total number of frames.....	30
7	b Movie length.....	86
8	Internal memory indicator.....	30
9	3D picture indicator.....	49
10	Print order icon.....	73

11	Crop icon.....	31
	Paint icon.....	73
	Quick retouch icon.....	73
	D-Lighting icon.....	73
	Stretch icon.....	73
	Perspective control icon.....	73
	Filter effects icon.....	73
	Glamour retouch icon.....	73
	Small picture icon.....	73
	Voice memo icon.....	73
12	Sequence display (when Individual pictures is selected).....	90
13	Album icon in favorite pictures mode ²	70
	Category icon in auto sort mode ²	70
14	Protect icon.....	73

¹ Icons displayed vary depending on the setting used for shooting.

² The icon for the selected album or category in auto sort mode currently selected in playback mode is displayed.

Playback Mode (Operation Controls)

Tap the following icons to change the camera mode or settings.

- Tap the **MENU** tab to display the menu options (📖 11) and deleting or editing will be available.
- The controls available displayed vary depending upon the displayed picture and the current camera settings.

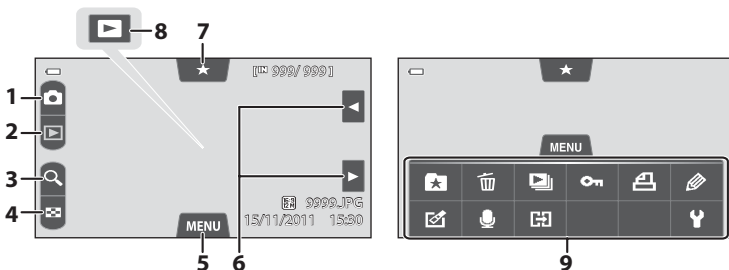

1	Switch to shooting mode ¹	10, 30	6	Previous/next picture	30
2	Playback mode ²	10, 30, 70	7	Rating tab	72
3	Playback zoom	31	8	Movie playback.....	86
4	Thumbnail display	31		Easy panorama playback.....	47
5	MENU tab.....	11		Sequence playback.....	30
			9	Menu options	12

¹ Icons displayed vary with the shooting mode.

² Icons displayed vary with current playback mode.

Switching Between Shooting Mode and Playback Mode

The camera has two modes of operation: Shooting mode, which is used for taking pictures, and playback mode, which is used for viewing pictures.

To switch to playback mode, tap the playback mode icon.

To switch to shooting mode, tap the shooting mode icon.

- While using playback mode, you can also switch to shooting mode by pressing the shutter-release button.

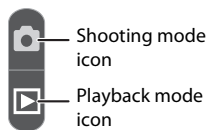

Shooting mode



Playback mode

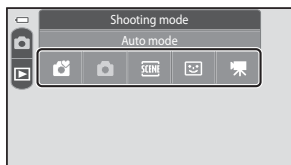
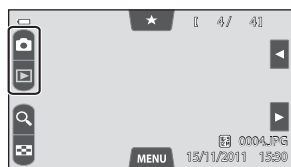

Shooting-mode selection menu

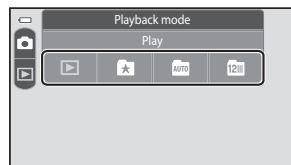

Playback-mode selection menu

- If you tap the shooting mode icon in shooting mode, the shooting-mode selection menu is displayed, from which you can select one of the available shooting modes.
- If you tap the playback mode icon in playback mode, the playback-mode selection menu is displayed, from which you can select one of the available playback modes.
- To select a desired shooting or playback mode, tap the icon of that mode.

Using Menu (MENU Tab)

During Shooting

Use the **MENU** tab to change the settings of each shooting mode.

- Change the settings before shooting.
- You can also change the general camera settings using the setup menu.



Tap the MENU tab

- If the **MENU** tab is hidden, tap **DISP**.

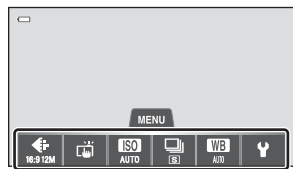

Tap a menu option

- The setting screen of the selected option is displayed.
- Tap **Y** to display the setup menu.
- To hide the menu options, tap the **MENU** tab.

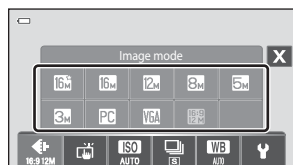

Tap a setting option to apply the setting

- To continue changing the settings for other options, tap the desired menu item to display the setting screen for that option.
- To finish using the menu, tap **X**.

During Playback

Use the **MENU** tab to delete or edit pictures.

- Select pictures before making changes.
You can select pictures by dragging them while the menu option selection screen is displayed.
- You can also change the general camera settings using the setup menu.



Tap the MENU tab

- If the **MENU** tab is hidden, tap the monitor.

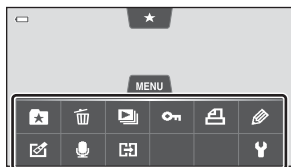

Tap a menu option

- The setting screen for the selected option is displayed.
- Tap **Y** to display the setup menu.
- To hide the menu options, tap the **MENU** tab.

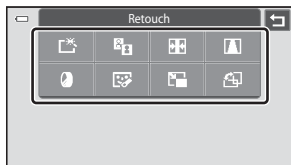

Tap a setting option to apply the setting

- To cancel the setting or finish using the menu, tap **Y** to return to the previous screen.



Basic Steps for Shooting and Playback

Preparation

Preparation 1 Insert the Battery	14
Preparation 2 Charge the Battery	16
Preparation 3 Insert a Memory Card	18



Shooting

Step 1 Turn the Camera On	20
Setting Display Language, Date and Time (First Use Only)	22
Step 2 Select a Shooting Mode	24
Step 3 Frame a Picture	26
Step 4 Focus and Shoot	28



Playback

Step 5 Play Back Pictures	30
Step 6 Delete Unwanted Pictures	32

Preparation 1 Insert the Battery

- 1 Open the battery-chamber/memory card slot cover.

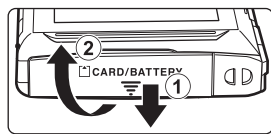

- 2 Insert the included EN-EL19 battery (rechargeable Li-ion battery).

- Use the edge of the battery to push the orange battery latch in the direction indicated by the arrow (1) and fully insert the battery (2).
- When the battery is inserted correctly, the battery latch will lock the battery in place.

Battery latch

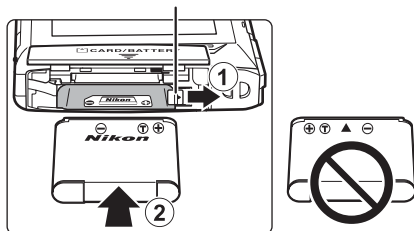

✓ Inserting the Battery Correctly

Inserting the battery upside down or backwards could damage the camera. Be sure to check that the battery is in the correct orientation.

- 3 Close the battery-chamber/memory card slot cover.

- Charge the battery before first use or when it is running low. See page 16 for more information.

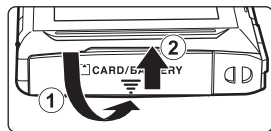

Removing the Battery

Close the slide cover to turn off the camera, make sure that the power-on lamp and the monitor are off, and then open the battery-chamber/memory card slot cover.

Slide the orange battery latch in the direction indicated by the arrow (①), and then remove the battery. Pull the battery straight out of the camera (②); do not pull it at an angle.

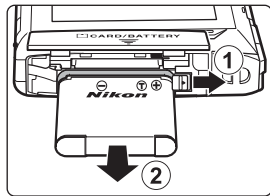

High Temperature Caution

The camera, battery, or memory card may be hot immediately after using the camera. Observe caution when removing the battery or memory card.

Note on the Battery

Be sure to read and follow the warnings for the battery on page vii and the section, "The Battery" (ⓘ: 3), before use.

Preparation 2 Charge the Battery

1 Prepare the included Charging AC Adapter EH-69P.

If a plug adapter* is included, attach the plug adapter to the plug on the Charging AC Adapter. Push the plug adapter firmly until it is securely held in place. Once the two are connected, attempting to forcibly remove the plug adapter could damage the product.

* The shape of the plug adapter varies according to the country or region in which the camera was purchased.

The Charging AC Adapter comes with the plug adapter attached in Argentina, Brazil, and Korea.

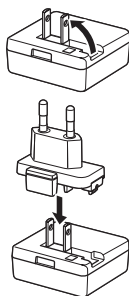

2 Make sure the battery is installed in the camera, and then connect the camera to the Charging AC Adapter in the order indicated by the numbers in the illustration below.

- Keep the camera turned off.
- Be sure that plugs are properly oriented. Do not attempt to insert plugs at an angle, and do not use force when connecting or disconnecting the plugs.

Power-on lamp

Electrical outlet

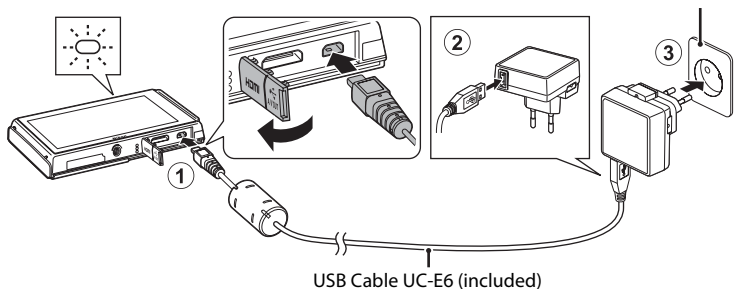

- The power-on lamp slowly blinks orange to indicate that the battery is charging.
- About 3 hours and 15 minutes are required to charge a fully exhausted battery.
- When the battery has been completely charged, the power-on lamp turns off.
- See "Understanding the Power-on Lamp" (📖 17) for more information.

3 Disconnect the Charging AC Adapter from the electrical outlet and then disconnect the USB cable.

- When the camera is connected to an electrical outlet with the Charging AC Adapter, the camera cannot be turned on.

Understanding the Power-on Lamp

Status	Description
Blinks slowly (orange)	Battery charging.
Off	Battery not charging. When charging is complete, the power-on lamp stops blinking orange and turns off.
Flickers (orange)	<ul style="list-style-type: none"> The ambient temperature is not suited to charging. Charge the battery indoors with an ambient temperature of 5°C to 35°C (41°F to 95°F). The USB cable or Charging AC Adapter is not properly connected, or there is a problem with the battery. Disconnect the USB cable or unplug the Charging AC Adapter and correctly connect it again, or change the battery.

Note on Charging AC Adapter

Be sure to read and follow the warnings for the Charging AC Adapter on page vii and the section, "Charging AC Adapter Information" (🔌 3), before use.

Charging Using Computer or Battery Charger

- Connecting the COOLPIX S100 to a computer also charges the Rechargeable Li-ion Battery EN-EL19 (📖 75, 🔌 93).
- The Battery Charger MH-66 (available separately; 🔌 99) can be used to charge Rechargeable Li-ion Battery EN-EL19 without the camera.

AC Power Source

- If the AC Adapter EH-62G (available separately; 🔌 99) is used, COOLPIX S100 can be powered from an electrical outlet and operated for shooting or playback.
- Do not, under any circumstances, use another make or model of AC adapter other than the EH-62G. Failure to observe this precaution could result in overheating or in damage to the camera.

Preparation 3 Insert a Memory Card

- 1 Be sure that the power-on lamp and the monitor are off and open the battery-chamber/memory card slot cover.

- Be sure to close the slide cover to turn off the camera before opening the cover.

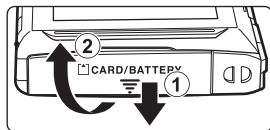

- 2 Insert the memory card.

- Slide the memory card in the correct orientation until it clicks into place.

✓ Inserting the Memory Card

Inserting the memory card upside down or backwards could damage the camera or the memory card. Be sure that the memory card is in the correct orientation.

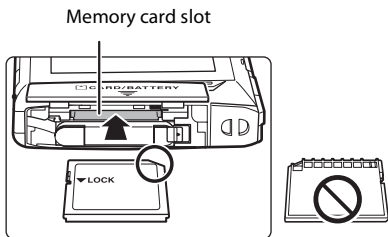

- 3 Close the battery-chamber/memory card slot cover.

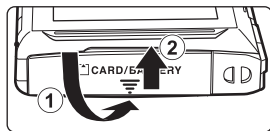

✓ Formatting a Memory Card

- The first time you insert a memory card that has been used in another device into this camera, be sure to format it with this camera.
- **All data stored on a memory card is permanently deleted when the card is formatted.** Be sure to transfer important pictures to a computer and save them before formatting.
- To format a memory card, insert the memory card into the camera and select **Format card** (📖 89) from the setup menu (📖 88).

✓ Note on Memory Cards

Refer to the documentation included with the memory card, as well as "Memory Cards" (🔍 4) in "Maximizing Camera Life and Performance".

Removing Memory Cards

Close the slide cover to turn off the camera, make sure that the power-on lamp and the monitor have turned off and open the battery-chamber/memory card slot cover.

Gently push the memory card into the camera (①) to partially eject the card, and then remove the card. Pull the memory card straight out of the camera (②); do not pull it at an angle.

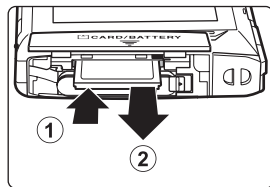

High Temperature Caution

The camera, battery, or memory card may be hot immediately after using the camera. Observe caution when removing the battery or memory card.

Internal Memory and Memory Cards

Camera data, including still pictures and movies, can be saved in either the camera's internal memory (approximately 71 MB) or on a memory card. To use the camera's internal memory for shooting or playback, first remove the memory card.

Approved Memory Cards

The following Secure Digital (SD) memory cards have been tested and approved for use in this camera.

- Memory cards with an SD Speed Class rating of 6 or faster are recommended for recording movies. Movie recording may stop unexpectedly when memory cards with a lower Speed Class rating are used.

	SD memory card	SDHC memory card ²	SDXC memory card ³
SanDisk	2 GB ¹	4 GB, 8 GB, 16 GB, 32 GB	64 GB
TOSHIBA	2 GB ¹	4 GB, 8 GB, 16 GB, 32 GB	64 GB
Panasonic	2 GB ¹	4 GB, 8 GB, 12 GB, 16 GB, 32 GB	48 GB, 64 GB
Lexar	–	4 GB, 8 GB, 16 GB, 32 GB	–

¹ If the memory card is used with a card reader or similar device, be sure that the device supports an SD memory card of 2 GB or more.

² SDHC compliant. When using the memory card with a card reader or similar device, be sure that the device is compliant with the SDHC standard.

³ SDXC compliant. When using the memory card with a card reader or similar device, be sure that the device is compliant with the SDXC standard.

Contact the manufacturer for details on the above cards.



Step 1 Turn the Camera On

- 1 Open the slide cover to turn on the camera.

If you are turning the camera on for the first time, see “Setting Display Language, Date and Time” (22).

- The monitor turns on.

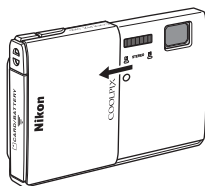

- 2 Check the battery level and the number of exposures remaining.

Battery level indicator

Number of exposures remaining



Battery Level Indicator

Indicator	Description
	Battery level high.
	Battery level low. Prepare to charge or replace the battery.
 Battery exhausted.	Cannot take pictures. Charge or replace the battery.

Number of Exposures Remaining

The number of pictures that can be taken is displayed.

- If a memory card is not inserted, **IN** is displayed to indicate that pictures will be saved in the camera's internal memory (approximately 71 MB).
- The number of exposures remaining varies depending on whether you are using the camera's internal memory or a memory card, and also varies depending on the image quality and image size (image mode) setting (62).
- The number of exposures remaining shown in the illustrations may differ from the actual display.

Turning the Camera On and Off

- When the camera is turned on, the power-on lamp (green) will light, and then the monitor will turn on (the power-on lamp turns off when the monitor turns on).
- To turn off the camera, close the slide cover. The power-on lamp and the monitor will turn off.

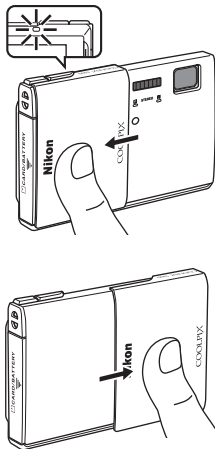

✓ Notes on Opening and Closing the Slide Cover

- Be sure to keep your fingers or other objects away from the lens when opening and closing the slide cover.
- The camera turns on before the slide cover is fully open, but shooting is not possible until the cover is fully open.
- When the camera is not in use, close the slide cover completely. Otherwise, power continues to be consumed even when the monitor is off, and the battery runs low.

🔪 Power Saving Function (Auto Off)

If no operations are performed for a while, the monitor will turn off, the camera will enter standby mode, and the power-on lamp will blink.

While the power-on lamp is blinking, press the shutter-release button to reactivate the monitor.

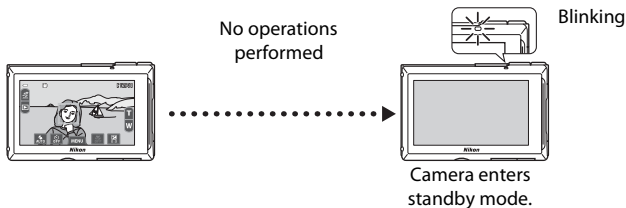



- The time allowed to elapse before the camera enters standby mode can be changed from the **Auto off** option in the setup menu (📖 88).
- Camera enters standby mode in about a minute (default setting) during shooting or playback mode.
- When the AC Adapter EH-62G (available separately) is used, a screen saver function is activated to prevent screen burn when no operations are performed for about a minute (default setting).

Step 1 Turn the Camera On

Setting Display Language, Date and Time

A language-selection dialog is displayed the first time the camera is turned on.

1 Tap the desired language.

- If the desired language is not displayed, tap  or  to view other language options.
- For more information about operating the touch panel, see “Operating the Touch Panel” (📖 4).



2 Tap **Yes**.

- Tap **No** to cancel making the settings.

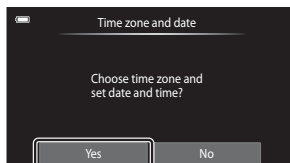

3 Tap or to select your home time zone and tap **OK**.

- See page 23 for information about enabling daylight saving time.

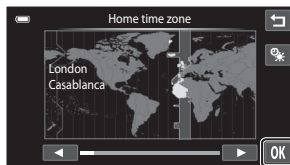

4 Tap the order in which the day, month, and year are displayed.

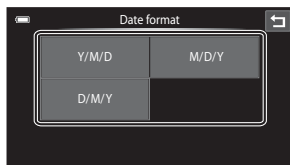

5 Edit the date and time.

- Tap the desired field and  or  to edit the value.



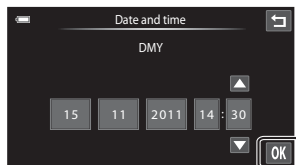

6 Tap **OK**.

- The clock is activated and the camera enters shooting mode.





Daylight Saving Time

If daylight saving time is in effect, tap  in the time zone selection screen displayed in step 3 to turn on the daylight saving time function.

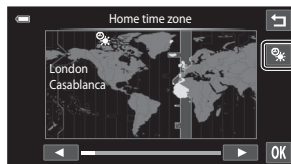
When the daylight saving time function is enabled,  is displayed at the top of the monitor. To turn off the daylight saving time function, tap  again.





Changing the Language or Date and Time Setting

- You can change these settings using the **Language** and **Time zone and date** settings in the setup menu ( 88).
- When the daylight saving time function is enabled in **Time zone** in **Time zone and date** in the setup menu, the camera clock moves forward one hour, and when it is disabled, it moves back one hour. When **Travel destination** () is selected, the local time is automatically calculated and the shooting date and time of the selected region are recorded with the pictures.
- If you exit without setting the date and time,  will blink when the shooting screen is displayed. Use the **Time zone and date** setting in the setup menu to set the date and time.

The Clock Battery

- The camera's clock is powered by a backup battery that is separate from the camera's main battery. The backup battery charges when the main battery is inserted into the camera or when the camera is connected to an optional AC adapter, and can provide several days of backup power after about ten hours of charging.
- If the camera's backup battery becomes exhausted, the date and time setting screen is displayed when the camera is turned on. Set the date and time again. See "Setting Display Language, Date and Time" (step 2,  22) for more information.

Imprinting the Shooting Date in Printed Pictures

- Set the date and time before shooting.
- You can permanently imprint the shooting date in pictures as they are taken by setting **Print date** in the setup menu ( 88).
- You can use the ViewNX 2 software ( 76) to print the shooting date in pictures that were taken without using the **Print date** option.



Step 2 Select a Shooting Mode

1 Tap the shooting mode icon.





- The shooting-mode selection menu which allows you to select the desired shooting mode, is displayed.

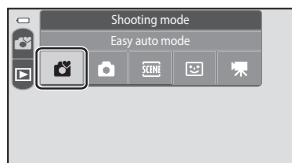

2 Tap the desired shooting mode icon.

-  (easy auto) mode is used in this example. Tap  **Easy auto mode**.



- The camera enters  (easy auto) mode. The shooting mode icon changes to , , , or  depending on the current subject and framing.
- See page 6 for information about the icons on the monitor.
- The shooting mode setting is saved when the camera is turned off.

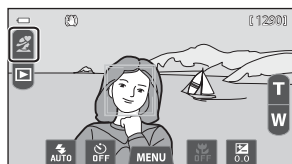



Available Shooting Modes

Easy auto mode 36

By simply framing a picture, the camera automatically selects the optimum shooting mode.

Auto mode 37

 (auto) mode is useful for general photography, and it allows you to adjust a variety of settings in the shooting menu ( 38) to suit the shooting conditions and the type of shot you want to capture.

Scene 40

When a shooting scene is selected, the camera settings are optimized to take pictures of that type of scene.

- To select a scene mode, tap the icon of the desired scene mode in the shooting-mode selection menu.



Smart portrait 50

The camera detects human faces and automatically releases the shutter when they smile (smile timer). The skin softening option can be used to make skin tones of human faces displayed smoothly.

Movie 82

Shoot movies with sound recorded via the built-in microphone.

Features That Are Available in Each Shooting Mode

- You can change the flash mode, self-timer, macro mode, and exposure compensation. See “Basic Shooting Settings” ( 53) for more information.
- When using shooting mode, tap **MENU** tab ( 11) to display the menu for the selected mode. See “Shooting Features” ( 35) for information about the menu options available for the current shooting mode.

Step 3 Frame a Picture

1 Hold the camera steadily in both hands.

- Keep fingers and other objects away from the lens, flash, AF-assist illuminator, and microphone.
- When taking pictures in portrait (“tall”) orientation, turn the camera so that the built-in flash is above the lens.

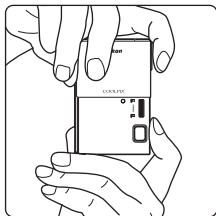
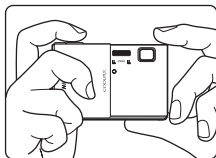

2 Frame the picture.

- When the camera automatically selects the optimum scene mode, the shooting mode icon will be changed (📖 36).
- When the camera detects a face, that face will be framed by a yellow double border (focus area). See “Face Detection” (📖 65) for more information.
- When taking pictures of subjects other than people, or framing a subject with which no face is detected, a focus area will not be displayed. Frame the picture so that the intended subject is at or near the center of the frame.

Shooting mode icon



✓ Notes on 📷 (Easy Auto) Mode

- The desired scene mode may not be selected in certain condition. In this case, select another shooting mode.
- When digital zoom is in effect, shooting mode is 📷.

🔧 Using a Tripod

- We recommend using a tripod to stabilize the camera when shooting in the following situations:
 - When shooting in dim lighting or when the flash mode (📖 55) is set to 📷 (off).
 - When using the telephoto setting.
- Set **Vibration reduction** in the setup menu (📖 88) to **Off** when using a tripod to stabilize the camera.

Using the Zoom

Tap **T** or **W** to activate optical zoom.

- To enlarge the subject, tap **T**.
- To capture a wide area, tap **W**.
The zoom position is set at the maximum wide-angle position when the camera is turned on.
- A zoom indicator is displayed in the monitor during zooming.

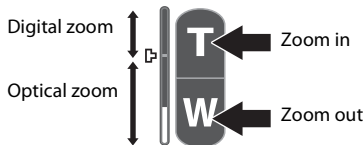

Digital Zoom

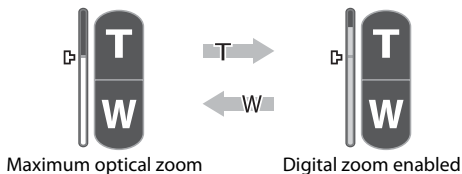

When the camera is zoomed in to the maximum optical zoom position, touching and holding **T** triggers digital zoom. The subject is magnified up to 4x the maximum optical zoom ratio when using digital zoom.



- The camera focuses at the center of the frame and the focus area is not displayed when digital zoom is in effect.

Digital Zoom and Interpolation

- Unlike optical zoom, digital zoom uses a digital imaging process known as interpolation to magnify images, resulting in slight deterioration of picture quality according to the image mode (📖 62) and digital zoom magnification.

Interpolation is applied at zoom positions beyond . When zoom is increased beyond the  position, interpolation is initiated and the zoom indicator turns yellow to indicate that interpolation is being applied.  moves up as the image size becomes smaller, allowing you to confirm the zoom position that can be used to capture still images without image degradation before shooting at the current image size setting.

- Digital zoom can be disabled from the **Digital zoom** option in the setup menu (📖 88).

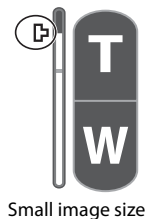



Step 4 Focus and Shoot

1 Press the shutter-release button halfway, i.e., press the button slightly until you feel resistance.

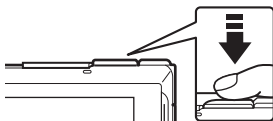
- When you press the shutter-release button halfway, the camera sets the focus and exposure (shutter speed and aperture value). Focus and exposure remain locked while the shutter-release button is pressed halfway.
- When a face is detected, it is framed by the double border indicating the active focus area. When the subject is in focus, the double border turns green.



Shutter speed Aperture value

- If no face is detected and  or  is displayed as the shooting mode icon, the camera automatically selects one (or more) of the nine focus areas containing the subject closest to the camera. When the subject is in focus, the focus area that is selected glows green (up to nine areas). If a shooting mode icon other than those above is displayed, the camera focuses on the subject at the center of the frame (📖 6).
- When digital zoom is used, the focus area is not displayed and the camera focuses at the center of the frame. Once focus has been acquired, the focus indicator (📖 6) will glow green.
- If the focus area or the focus indicator blinks red when the shutter-release button is pressed halfway, the camera is unable to focus. Modify the composition and press the shutter-release button halfway again.

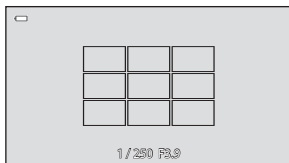

2 Press the shutter-release button all the way, i.e., press the button the rest of the way down.

- The shutter is released and the picture will be recorded to the memory card or internal memory.
- If you press the shutter-release button with too much force, the camera may shake, causing pictures to be blurred. Press the button gently.



✓ During Recording

- While pictures are being recorded, the number of exposures (📖 20) remaining will blink. **Do not open the battery-chamber/memory card slot cover** while pictures are being recorded. Cutting power or removing the memory card in these circumstances could result in loss of data or in damage to the camera or card.
- It may take some time for the picture to be saved depending on the current settings or the shooting conditions (🔧 11).

✓ Subjects Not Suitable for Autofocus

Autofocus may not perform as expected in the following situations. In some rare cases, the subject may not be in focus despite the fact that the focus area or the focus indicator glows green.

- Subject is very dark
- Objects of sharply differing brightness are included in the scene (e.g. the sun behind the subject makes that subject appear very dark)
- No contrast between the subject and surroundings (e.g. a portrait subject, wearing a white shirt, is standing in front of a white wall)
- Several objects are at different distances from the camera (e.g. the subject is inside a cage)
- Regular geometric patterns (e.g. window blind or windows in a skyscraper)
- Subject is moving rapidly

In the situations noted above, try pressing the shutter-release button halfway to refocus several times, or try focusing on another subject that is at the same distance from the camera as the intended subject (📖 39).

📎 Touch Shutter

At the default setting, the shutter can be released by simply tapping a subject in the monitor (📖 38) without pressing the shutter-release button. The **Touch shutter** option can be changed to the **Touch AF/AE** option, which allows the camera to set the focus and exposure on the subject that is tapped on the monitor. When using the **Touch AF/AE** option, the picture is taken by pressing the shutter-release button.

📎 AF-assist Illuminator and Flash

If the subject is poorly lit, the AF-assist illuminator (📖 89) may light when the shutter-release button is pressed halfway, or the flash (📖 54) may fire when the shutter-release button is pressed all the way down.

📎 To Make Sure You Do Not Miss a Shot

If you are concerned that you might miss a shot, press the shutter-release button all the way without first pressing it halfway.

📎 Motion Detection

In 📷 (easy auto) mode or 📷 (auto) mode, when the camera detects subject movement or camera shake, ISO sensitivity and shutter speed are increased to reduce blurring. In this case, the shutter speed indicator will turn green.

Step 5 Play Back Pictures

1 Tap the playback mode icon (▶).

- The camera enters playback mode, and the last picture taken is displayed in full-frame playback mode.

Shooting

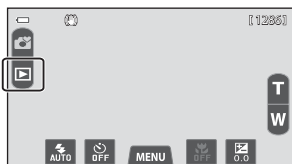

Playback

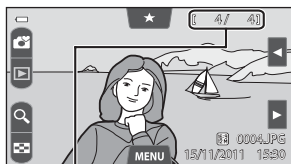

Current picture number/total number of pictures

- To play back pictures that are saved in the internal memory, remove the memory card. **IN** is displayed in place of the “current picture number/total number of pictures” indicator.
- When a certain type of pictures is selected for playback (▶ 70), the total number of pictures in the selected type is displayed as the “total number of pictures.”

2 Drag the current picture to display the previous or next picture.

- To display the previous picture, drag the picture to the right or tap **◀**.
- To display the next picture, drag the picture to the left or tap **▶**.
- Hold **◀** or **▶** to scroll backward or forward through the pictures.
- Tap the shooting mode icon (📷) displayed at upper left in the monitor or press the shutter-release button to return to shooting mode.

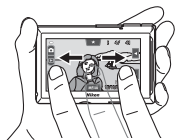

Viewing Pictures

- The previous or next picture may appear briefly at low resolution immediately after it is dragged into view.
- When using playback mode, pictures are automatically rotated for display according to the orientation when they are taken. The orientation of pictures can be changed using **Rotate image** (▶ 73).
- Each series of pictures taken using continuous shooting is saved in a sequence, and by default, only the first picture in the sequence (key picture) is displayed to represent them (▶ 74, 90). Tap **▶** to display them as individual pictures.

More Information

- See “Selecting Certain Types of Pictures for Playback” (▶ 70) for more information.
- See “Features Available in Playback Mode (Playback Menu)” (▶ 73) for more information.

Changing How Pictures Are Displayed

Playback Zoom

Spread two fingers apart on the monitor when using playback mode.

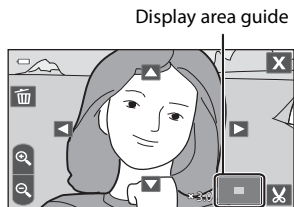
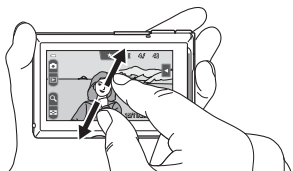

- You can also zoom in on pictures by tapping or tapping a picture twice quickly. When zooming in on a picture taken using face detection (66) or pet detection (48), the face detected at the time of shooting is displayed in the center of the monitor by tapping or double-tapping that face.
- This feature is useful for checking to see if a picture is in focus. Pictures can be zoomed in up to 10x. To delete pictures, tap .
- The zoom ratio changes as your fingers move (spreading apart or pinching together). You can also change the zoom ratio by tapping or .
- To view a different area of the picture, drag the picture or tap , , , or .
- You can crop the picture and save the displayed area of the picture as a separate file by tapping .
- Tap or tap a picture twice quickly to return to full-frame playback mode.

Thumbnail Playback

Pinch two fingers together when using playback mode.

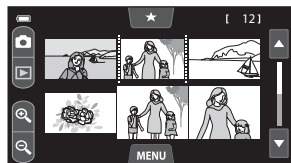
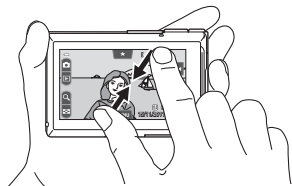

6, 12, and 20 pictures per screen

- You can also display thumbnails by tapping .
- You can view several pictures on one screen, making it easy to find the picture you want.
- The number of thumbnails displayed changes as your fingers move (spreading apart or pinching together). You can also change the number of thumbnails by tapping or .
- To scroll through the display, drag your finger vertically, or tap or .
- Tap a picture to display that picture in full-frame playback mode.

Step 6 Delete Unwanted Pictures

- 1 Play back a picture to be deleted, tap the **MENU** tab, and tap .

See “Using Menus (MENU Tab)” (📖 11) for more information.



- 2 Tap the desired delete option.

- **Current image:** Delete the currently displayed full-frame picture.
- **Erase selected images:** Select multiple pictures and delete them. See “Operating the Erase Selected Images Screen” (📖 33) for more information.
- **All images:** Delete all pictures.
- If step 1 is performed in thumbnail playback mode (📖 31), select either **Erase selected images** or **All images**.

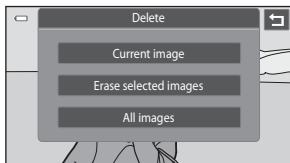

- 3 Tap **Yes** on the delete confirmation dialog.



- Deleted pictures cannot be recovered.
- To exit without deleting the picture, tap  or **No**.



Notes on Deleting Pictures





- Once deleted, pictures cannot be recovered. Transfer important pictures to a computer or other media before deleting them.
- Protected pictures (📖 73) cannot be deleted.

Deleting Pictures in a Sequence

- If you tap the **MENU** tab and delete a key picture while only key pictures are displayed for sequences of pictures (📖 30), all pictures in the sequence, including the key picture, are deleted.
- To delete individual picture in a sequence, tap  to display them one at a time, tap the **MENU** tab, and tap .

Operating the Erase Selected Images Screen

1 Tap a picture to display .

- To deselect the picture, tap the picture again and  will be removed.
- Tap  or  to scroll through the display.
- Tap  or  to change the number of pictures displayed.



2 Add to all pictures to be delete and tap **OK** to apply the selection.

- The confirmation screen is displayed. Follow the onscreen instructions for more operations.

Selecting Certain Types of Pictures for Deletion

When using favorite pictures mode, auto sort mode or list by date mode ( 70), you can select pictures for deletion from an album, category, or shooting date.



A series of horizontal dashed lines spanning the width of the page, intended for handwriting practice.

Shooting Features

This chapter describes each of the camera's shooting modes and the features that are available when using each shooting mode.

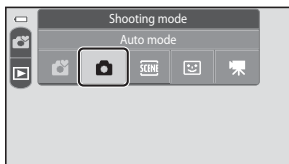

By referring to this information, you will learn how to select different shooting modes and adjust settings according to the shooting conditions and the kind of pictures you want to take.

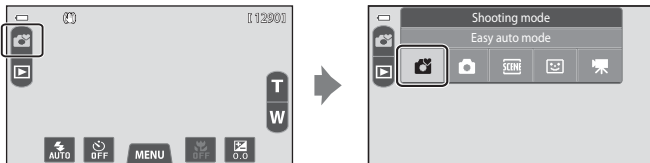

(Easy Auto) Mode

When you frame a picture, the camera automatically selects the optimum scene from the list below, allowing you to easily take pictures using a shooting mode that suits the scene.



- : Portrait
- : Landscape
- : Night portrait
- : Night landscape
- : Close-up
- : Backlighting
- : Other shooting scenes

- When digital zoom is in effect,  is selected as the shooting scene.
- Active focus areas change depending on the selected scene. If a human face is detected, the camera focuses on it. See “Face Detection” (📖 65) for more information.
- At the default setting, the shutter can be released simply by tapping a subject in the monitor (touch shutter) (📖 38) without pressing the shutter-release button. When the camera detects any faces, the shutter can be released by tapping a detected face framed by a border.

Changing the (Easy Auto) Mode Settings

- You can change the flash mode, self-timer, and exposure compensation. See “Basic Shooting Settings” (📖 53) for more information.
- If you tap the **MENU** tab (📖 11), the available menu options are displayed. You can change the **Image mode** (📖 62) and **Touch shooting** (📖 38) settings in  (easy auto) mode.
 - If you change the **Image mode** setting, the new setting is applied to all shooting modes.
 - **Touch shutter** (default setting) or **Touch AF/AE** can be selected for **Touch shooting**.

📷 (Auto) Mode

📷 (auto) mode is useful for general photography, and it allows you to adjust a variety of settings in the shooting menu (📖 38) to suit the shooting conditions and the type of shot you want to capture.

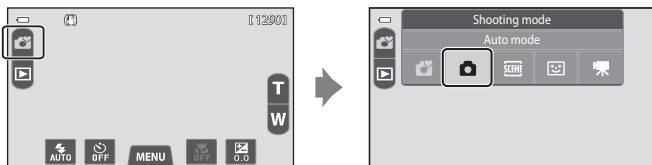

- If the camera detects a human face, the camera automatically focuses on it (see “Face Detection” (📖 65) for more information).
- When no face is detected, the camera automatically selects one (or more) of the nine focus areas containing the subject closest to the camera. When the subject is in focus, the focus area that is selected glows green (up to nine areas).
- At the default setting, the shutter can be released by simply tapping a subject in the monitor (📖 38) without pressing the shutter-release button.

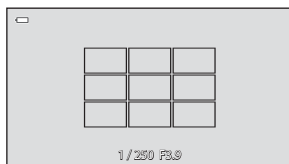

The **Touch shutter** option can be changed to the **Touch AF/AE** option, which allows the camera to set the focus and exposure on the subject that is tapped on the monitor (touch shutter) (📖 38). When using the **Touch AF/AE** option, the picture is taken by pressing the shutter-release button.

- The **Subject tracking** option, which moves the active focus area to track the registered subject, can be enabled (📖 38).

Adjusting the 📷 (Auto) Mode Settings

- You can change the flash mode, self-timer, macro mode, and exposure compensation. See “Basic Shooting Settings” (📖 53) for more information.
- If you tap the **MENU** tab (📖 11), the menu options available in 📷 (auto) mode are displayed. See “Shooting Menu Options in 📷 (Auto) Mode” (📖 38) for more information.

Shooting Menu Options in 📷 (Auto) Mode

In 📷 (auto) mode, the following options can be changed.

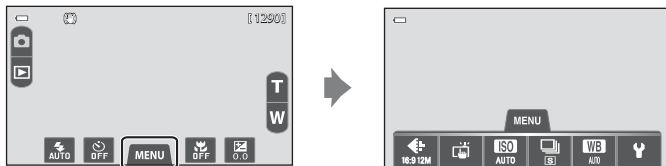

Option	Description	
🔍 Image mode	Allows you to select the combination of image size and image quality used when saving pictures (📖 62). The default setting is 📷 4608×2592 . This setting is applied to all shooting modes.	62
📷/📷/📷 Touch shooting	Select between Touch shutter (default settings), which allows you to release the shutter by tapping the monitor, Touch AF/AE , which allows you to set the focus area by tapping the monitor, and Subject tracking , which moves the focus area to track the registered subject.	📷 49
ISO ISO sensitivity	Higher ISO sensitivity allows you to take pictures of darker subjects. Additionally, even with subjects of similar brightness, pictures can be taken at faster shutter speeds, and blurring caused by camera shake and subject movement can be reduced. When ISO sensitivity is set to Auto (default setting), the camera sets the ISO sensitivity automatically.	📷 56
📷 Continuous	Allows you to take a series of pictures. While Continuous H is selected and the shutter-release button is held down, up to 3 pictures are taken at a rate of about 8.1 frame per second (fps) when image mode is set to 📷 4608×2592 . The default setting is Single (i.e., only one picture is taken at a time).	📷 57
WB White balance	Allows you to adjust the colors in the picture so that they appear as they do to the eye. Although Auto (default setting) can be used under most types of lighting, white balance can be adjusted to suit the sky conditions or light source and achieve more natural color tones in the picture. <ul style="list-style-type: none"> Set the flash mode (📖 54) to 📷 (off) when white balance is set to any setting other than Auto and Flash. 	📷 59

📌 Functions That Cannot Be Used Simultaneously

There are functions with which these settings cannot be enabled (📖 64).

Shooting Subjects Not Suitable for Autofocus

When shooting a subject that is not suitable for autofocus (29), try pressing the shutter-release button halfway to refocus several times, or try the following techniques.

- 1 Switch to (auto) mode (37) and select **Touch AF/AE** (38) for the touch shooting setting.



- 2 Tap another subject that is as far from the camera as the desired subject.

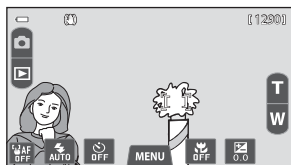

- 3 Press the shutter-release button halfway.

- The camera focuses on the subject and the focus area glows green.
- Exposure is locked for the subject on which focus is acquired when the shutter-release button is pressed halfway.

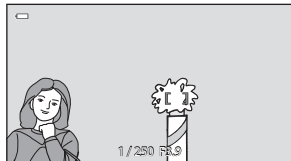

- 4 Continue holding down the shutter-release button halfway and recompose the picture.

- Be sure to maintain the same distance between the camera and the subject while the shutter-release button is pressed halfway.



- 5 Press the shutter-release button the rest of the way down to take the picture.



Scene Mode (Shooting Suited to the Scene)

You can take pictures with the optimal camera settings for the subject type by selecting the shooting scene from the list below.

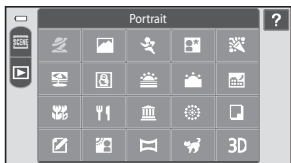
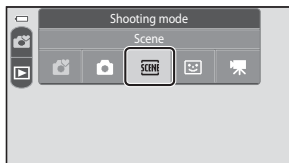

To select a scene, tap the desired scene icon on the screen shown at the left.

Portrait (42)	Landscape (42)	Sports (42)	Night portrait (43)
Party/indoor (43)	Beach (43)	Snow (43)	Sunset (44)
Dusk/dawn (44)	Night landscape (44)	Close-up (44)	Food (45)
Museum (45)	Fireworks show (45)	Black and white copy (45)	Draw (46)
Backlighting (46)	Panorama (47)	Pet portrait (48)	3D 3D photography (49)

To View a Description (Help Information) of Each Scene

Tap in the scene selection screen to display the **Help selection** screen. Tap a scene icon to view a description of that scene. To return to the previous screen, tap .

Changing the Scene Mode Settings

- You can change the flash mode, self-timer, macro mode, and exposure compensation for some scenes. See “Default Settings” (📖 60) for more information.
- If you tap the **MENU** tab (📖 11), the available menu options are displayed. You can set the **Image mode** (📖 62) and **Touch shooting** (📖 38) settings in scene mode (the settings cannot be changed in some scenes).
 - If you change the **Image mode** setting, the new setting is applied to all shooting modes.
 - Touch shutter** (default setting) or **Touch AF/AE** can be selected for **Touch shooting**.





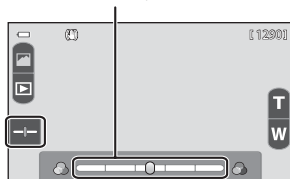

Adjusting Scene Effect

The scene effect adjustment slider is displayed by tapping  in the scene modes listed below.

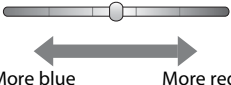
- Tap or drag the scene effect adjustment slider to adjust the degree of effect to be applied to pictures taken in the selected scene mode.
- After you finish making the adjustment, tap  to hide the scene effect adjustment slider.

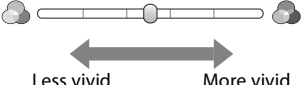
Scene effect adjustment slider



 Food	
 Landscape,  Close-up	
 Sunset,  Dusk/dawn	

The changes made to the scene effects are stored in the camera's memory even after the camera is turned off.

Selecting a Scene Mode to Take Pictures (Features)

Portrait

Use this mode for portraits.

- The camera detects a human face and focuses on it (📖 65).
- The camera smoothes facial skin tones by applying the skin softening function before recording pictures (📖 67).
- If no faces are detected when the shutter-release button is pressed halfway, the camera focuses on the subject at the center of the frame.
- Digital zoom is not available.



Landscape

Use this mode for vivid landscapes and cityscapes.

- When the shutter-release button is pressed halfway, focus areas or the focus indicator (📖 6) always lights in green.
- Use the scene effect adjustment slider (📖 41) to adjust picture saturation.



Sports

Use this mode for dynamic action shots that freeze the action in a single shot and record motion in a series of pictures.

- The camera focuses at the center of the frame. The focus area can be changed with the touch shutter or touch AF/AE option (📖 38).
- To take pictures continuously, hold down the shutter-release button. Up to 18 pictures are taken at a rate of about 1.4 frame per second (fps) when image mode is set to  **4608x2592**.
- The camera continuously adjusts focus even when the shutter-release button is not pressed halfway. As a result, you may hear the sound of the lens focus motor.
- During continuous shooting, focus, exposure, and white balance are fixed at the values determined with the first picture in each series.
- The frame rate with continuous shooting may vary depending upon the current image mode setting, the memory card used, or shooting condition.
- Continuous shooting is disabled and only one picture can be taken at a time when the shutter is released using the touch shutter function (📖 38).



Use of a tripod is recommended in the scenes with  is indicated. Set **Vibration reduction** in the setup menu (📖 88) to **Off** when using a tripod to stabilize the camera.

Night portrait



Use this mode for portraits taken at sunset or at night.

- The camera detects a human face and focuses on it. See page 65 for more information.
- The camera smoothes facial skin tones by applying the skin softening function before recording pictures (📖 67).
- If no faces are detected when the shutter-release button is pressed halfway, the camera focuses on the subject at the center of the frame.
- Digital zoom is not available.



Party/indoor

Captures the effects of candlelight and other indoor background lighting.

- The camera focuses at the center of the frame. The focus area can be changed with the touch shutter or touch AF/AE option (📖 38).
- Hold the camera steadily when shooting in dark surroundings. If you use a tripod to stabilize the camera, Set **Vibration reduction** to **Off** in the setup menu (📖 89).



Beach

Captures the brightness of such subjects as beaches or sunlit expanses of water.

- The camera focuses at the center of the frame. The focus area can be changed with the touch shutter or touch AF/AE option (📖 38).



Snow

Captures the brightness of sunlit snow.

- The camera focuses at the center of the frame. The focus area can be changed with the touch shutter or touch AF/AE option (📖 38).



Scene Mode (Shooting Suited to the Scene)

Sunset



Preserves the deep hues seen in sunsets and sunrises.

- The camera focuses at the center of the frame.
- Use the scene effect adjustment slider (📖 41) to adjust picture color.



Dusk/dawn



Preserves the colors seen in the weak natural light before sunrise or after sunset.

- When the shutter-release button is pressed halfway, focus areas or the focus indicator (📖 6) always lights in green.
- Use the scene effect adjustment slider (📖 41) to adjust picture color.



Night landscape



Slow shutter speeds are used to produce stunning night landscapes.

- When the shutter-release button is pressed halfway, focus areas or the focus indicator (📖 6) always lights in green.
- Digital zoom is not available.



Close-up

Photograph flowers, insects and other small objects at close range.

- Macro mode (📖 58) is enabled and the camera automatically zooms to the closest position at which it can focus.
- The camera focuses at the center of the frame. The focus area can be changed with the touch shutter or touch AF/AE option (📖 38).
- Use the scene effect adjustment slider (📖 41) to adjust picture saturation.
- The camera continuously adjusts focus even when the shutter-release button is not pressed halfway. As a result, you may hear the sound of the lens focus motor.



Use of a tripod is recommended in the scenes with which  is indicated. Set **Vibration reduction** in the setup menu (📖 88) to **Off** when using a tripod to stabilize the camera.

Food

Use when taking pictures of food.

- Macro mode (📖 58) is enabled and the camera automatically zooms to the closest position at which it can focus.
- The camera focuses at the center of the frame. The focus area can be changed with the touch shutter or touch AF/AE option (📖 38).
- Use the scene effect adjustment slider to adjust the influence lighting has on the color of the subject (📖 41).
- The camera continuously adjusts focus even when the shutter-release button is not pressed halfway. As a result, you may hear the sound of the lens focus motor.



Museum

Use indoors where flash photography is prohibited (for example, in museums and art galleries) or in other situations in which you do not want to use the flash.

- The camera focuses at the center of the frame. The focus area can be changed with the touch shutter or touch AF/AE option (📖 38).
- If you hold down the shutter-release button, the camera takes up to ten pictures and the sharpest picture in the series is automatically selected and saved (**BSS** (best shot selector)).
- BSS is disabled and only one picture can be taken at a time when the shutter is released using the touch shutter function (📖 38).



Fireworks show



Slow shutter speeds are used to capture the expanding burst of light from a firework.

- Camera focuses at infinity.
- When the shutter-release button is pressed halfway, focus areas or the focus indicator (📖 6) always lights in green.



Black and white copy



Provides clear pictures of text or drawings on a white board or in print.

- The camera focuses at the center of the frame. The focus area can be changed with the touch shutter or touch AF/AE option (📖 38).
- Use with macro mode (📖 58) when shooting a subject at close distance.



Scene Mode (Shooting Suited to the Scene)





Draw

Write a memo or draw a picture on the touch panel display and save it as an image. The image is saved at an image mode setting of  (640 × 480). See "Using the Draw Option" ( 2) for more information.

Backlighting

Use when light is coming from behind the subject, throwing features or details into shadow.

Tap the **MENU** tab ( 11) and tap **HDR HDR** to enable or disable the HDR (high dynamic range) function.

- When **HDR** is set to **Off** (default setting): The flash fires to prevent the subject from being hidden in shadow.
 - The camera focuses at the center of the frame. The focus area can be changed with the touch shutter or touch AF/AE option ( 38).
 - When the shutter-release button is pressed all the way down, one picture is taken.
- When **HDR** is set to **On**: Use when taking pictures with very bright and dark areas in the same frame.
 - If there are very bright areas and very dark areas in the frame, the color of the  icon is inverted.
 - Digital zoom is not available.
 - The camera focuses at the center of the frame. The focus area can be changed with the touch shutter or touch AF/AE option ( 38).
 - When the shutter-release button is pressed all the way down, the camera takes pictures continuously at high speed, and saves the following two images.
 - An image processed by D-Lighting ( 73) at the time of shooting
 - A composite image with high dynamic range (HDR) in which the loss of details in highlights or shadows is minimized
 - The second image saved is an HDR composite image. If there is only enough memory to save one image, an image processed by D-Lighting is the only image saved.
 - Once the shutter-release button is pressed all the way, hold the camera steadily without moving it until a still image is displayed. After taking a picture, do not turn the camera off before the monitor switches to the shooting screen.
 - The angle of view (i.e., the area visible in the frame) seen in the saved picture will be narrower than that seen in the monitor at the time of shooting.













Panorama



Use for taking panoramas.

Tap the **MENU** tab ( 11) to select  **Panorama** and then select from **EASY Easy panorama** or **ASSIST Panorama assist**.





- **Easy panorama** (default setting): Allows you to take a panorama picture viewable on the camera simply by moving the camera in the desired direction.
 - Press the shutter-release button all the way down, remove your finger from the button, and then slowly pan the camera across the scene. Shooting automatically ends when the camera captures the specified shooting range.
 - The camera focuses at the center of the frame when shooting starts.
 - The zoom position is fixed at wide-angle.
 - Tap the **MENU** tab ( 11) to select the shooting range from **STD Normal (180°)** or **WIDE Wide (360°)**.
 - If you tap  when a panorama taken using easy panorama is displayed in full-frame playback mode, the panorama is displayed so that the short edge of the panorama fits on the monitor, and the image scrolls automatically.
 - See “Using Easy Panorama (Shooting and Playback)” ( 3) for more information.
- **Panorama assist**: Takes a series of pictures that you can join together into a panorama on a computer.
 - Tap , , , or  to select the direction in which pictures will be joined in the completed panorama.
 - After taking the first picture using the shutter-release button or touch shutter, take the necessary shots while checking how each picture will connect to the next. To finish shooting, tap .
 - The camera focuses at the center of the frame for the first shot. The focus area can be changed using the touch shutter ( 38). Focus, exposure, and white balance are fixed at the values determined with the first picture in each series.
 - Transfer the pictures to a computer and use Panorama Maker 5 ( 7) to join them into a single panorama.
 - See “Using Panorama Assist” ( 6) for more information.

Scene Mode (Shooting Suited to the Scene)

Pet portrait

Use this mode for taking portraits of pets (dogs or cats). When the camera detects the face of a dog or cat, it focuses on the face and automatically releases the shutter (pet portrait auto release) 3 times at the default setting.



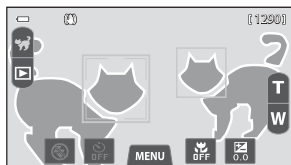

- A double border (focus area) is displayed around the detected face, and it turns green when the focus is acquired.
Up to five faces can be detected. When the camera detects more than one face, the double border is displayed around the largest face, and single borders are displayed around the others.
- If the shutter-release button is pressed halfway when no pet faces are detected, the camera focuses on the subject at the center of the frame.
- Digital zoom is not available.
- To change the  **Pet portrait auto release** setting, tap the **MENU** tab (📖 11).
 - **On** (default setting): The shutter is automatically released when the focus is acquired on the detected face.
 - **Off**: The shutter is released using the shutter-release button. When any pets are detected, you can tap a pet's face to release the shutter (📖 38).
- To change the  **Continuous** setting used in this mode, tap the **MENU** tab (📖 11).
 - **Single**: The camera takes one picture at a time.
 - **Continuous** (default setting): When the pet portrait auto release function is activated and the focus is acquired on the detected face, the camera releases the shutter 3 times (continuous shooting speed rate: about 1.4 frames per second when the image mode setting is  **4608x2592**). When the pet portrait auto release function is disabled, up to 18 pictures can be continuously taken at a rate of about 1.4 frames per second while the shutter-release button is held down (when the image mode setting is  **4608x2592**).
- Factors such as the distance between the pet and the camera, the orientation or brightness of the face, and the speed at which the pet is moving may prevent the camera from detecting the faces of dogs or cats or may cause the camera to display borders around faces other than those of dogs or cats.
- **Pet portrait auto release** is automatically set to **Off** in the following situations:
 - When continuous shooting is used five times in rapid succession with the pet portrait auto release function.
 - When the internal memory or memory card becomes full during shooting.To continue using the **Pet portrait auto release** function, tap the **MENU** tab and set  **Pet portrait auto release** to **On**.



Viewing Pictures That Were Taken Using Pet Detection



If you enlarge a picture by tapping  or tapping the face detected at the time of shooting twice quickly in full-frame playback mode, the picture is enlarged so that the detected face is displayed in the center of the monitor.

If the camera detected multiple faces when the picture was taken, you can tap  or  to display a different face. Once you change the zoom ratio, you will be able to zoom in on an area of the picture where there are no faces.

3D 3D photography

Use this mode for taking 3D pictures viewable in three dimensions on a 3D-compatible TV or monitor. The camera takes one picture for each eye to simulate a three-dimensional image.

Pictures taken in this mode are saved at an image size of  (1920 × 1080).

- After taking the first picture using the shutter-release button or touch shutter, move the camera horizontally to the right so that the subject is aligned with the guide on the monitor. The camera takes the second picture automatically.
- The camera focuses at the center of the frame for the first shot. The focus area can be changed with the touch shutter or touch AF/AE option ( 38). The focus, exposure, and white balance set for the first shot are used for the second shot.
- Digital zoom is not available.
- The angle of view (i.e., the area visible in the frame) seen in the saved picture will be narrower than that seen in the monitor at the time of shooting.
- The two captured images are saved as a 3D picture (MPO file) consisting of the left and right eye images. The first image (the left eye image) is also saved as a JPEG file.
- 3D pictures cannot be played back in 3D on the camera monitor. Only the left eye image of a 3D picture is displayed during playback.
- To view 3D pictures in 3D, connect the camera to a 3D-compatible TV or monitor using a 3D-compatible HDMI cable and set the playback mode to **3D playback** ( 70). Only 3D pictures are played back and output.
- Once an HDMI cable is connected, 3D pictures are output (played back) in 3D even when **3D playback** is not selected. However, it may take a while to display pictures when switching between 3D pictures and non-3D pictures.
- See “Taking 3D Pictures” ( 8) for more information.

Caution for Viewing 3D Pictures

When viewing 3D pictures on a 3D-compatible TV or monitor for an extended period of time, you may experience discomfort such as eye strain or nausea. Carefully read the documentation included with your TV or monitor to ensure proper use.

Smart Portrait Mode (Shooting Smiling Faces)

At the default setting, the camera detects faces and automatically releases the shutter when it detects a smile (smile timer). You can also use the skin softening option to smooth the skin tones in human faces. See “Skin Softening” (📖 67) for more information.

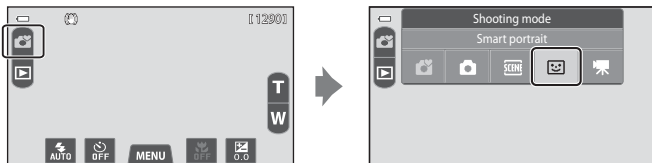

1 Point the camera at the human subject and wait for the subject to smile.

- When the camera detects a human face, the camera focuses on it (see “Face Detection” (📖 65) for more information).
- If the camera detects that the face framed by the double border is smiling, **Smile timer** (📖 52) is activated and the shutter is automatically released.
- Each time the shutter is released, the camera again initiates face detection and smile detection operations for continuous automatic shooting.

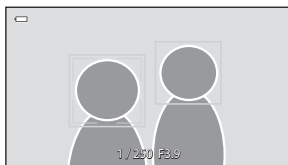

2 Stop shooting.

- To stop automatic shooting of smiling faces, perform one of the following operations:
 - Close the slide cover to turn off the camera.
 - Set **Smile timer** to **Off**.
 - Tap the shooting mode icon and switch to another shooting mode.

Notes on Smart Portrait Mode

- Digital zoom is not available.
- Under some shooting conditions, the camera may be unable to detect faces or smiles.
- See “Notes on the Face Detection Function” (📖 66) for more information.

Auto Off in Smile Timer Mode

When **Smile timer** is set to **On**, the auto off function (📖 89) is activated and the camera enters standby mode when either of the situations indicated below persists and no other operations are performed.

- The camera does not detect any faces.
- The camera detected a face, but cannot detect a smile.

Self-timer Lamp

The self-timer lamp blinks slowly when the smile timer is enabled and the camera detects a face, and it blinks quickly immediately after the shutter is released.

Releasing the Shutter Manually

- Pictures can also be taken by pressing the shutter-release button. The camera focuses on the subject at the center of the frame when faces are not detected.
- Touch shutter can be enabled when **Smile timer** is set to **Off** (📖 52).

Changing the Smart Portrait Mode Settings

- You can change the flash mode, self-timer, and exposure compensation. See “Basic Shooting Settings” (📖 53) for more information.
- If you tap the **MENU** tab (📖 11), the menu options available in smart portrait mode are displayed. See “Smart Portrait Menu Options” (📖 52) for more information.

Smart Portrait Menu Options

In smart portrait mode, the following options can be changed.

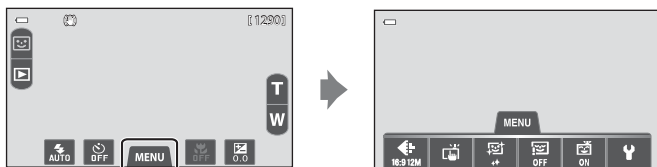

Option	Description	
Image mode	Allows you to select the combination of image size and image quality used when saving pictures. If you change the image mode setting, the new setting is applied to all shooting modes.	📖 62
Touch shooting	Choose from Touch shutter (default setting), which allows you to release the shutter by tapping the monitor, or Touch AF/AE , which allows you to set the focus area by tapping the monitor.	👁️ 49
Skin softening	Enables skin softening. The camera softens skin tones by applying the skin softening function before saving pictures. You can select the amount of effect applied. The default is Normal .	👁️ 61
Blink proof	When On is selected, the camera automatically releases the shutter twice each time a picture is taken. Of the two shots, one in which the subject's eyes are open is saved. When On is selected, the flash is disabled. The default setting is Off .	👁️ 61
Smile timer	When On (default setting) is selected, the camera detects human faces and then automatically releases the shutter whenever a smile is detected. Self-timer cannot be used with this option.	👁️ 61

Functions That Cannot Be Used Simultaneously

There are functions with which these settings cannot be enabled (📖 64).

Basic Shooting Settings

When in shooting mode, you can set the following functions by tapping the icons at the bottom of the monitor:



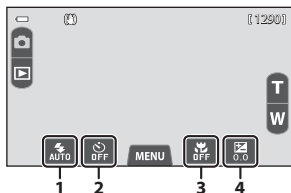

- 1 Flash mode
 - 2 Self-timer
 - 3 Macro mode
 - 4 Exposure compensation
- When the icons are hidden, tap **DISP.**



Functions Available for Each Shooting Mode

The default settings for each function that can be set in each shooting mode are described below.

- See “Default Settings” (📖 60) for more information on the default settings in each shooting mode.

Function	 (📖 36)	 (📖 37)	 (📖 40)	 (📖 50)	 (📖 82)
Flash mode (📖 54)	✓	✓	1	✓ ²	–
Self-timer (📖 56)	✓	✓		✓ ²	–
Macro mode (📖 58)	– ³	✓		–	✓
Exposure compensation (📖 59)	✓	✓		✓	–

¹ Varies with the scene mode. See “Default Settings” (📖 60) for more information.

² Varies with the smart portrait mode settings. See “Default Settings” (📖 60) for more information.

³ Macro mode is enabled when  is selected.

Functions That Cannot Be Used Simultaneously

There are functions with which these settings cannot be enabled (📖 64).

Using the Flash (Flash Modes)

You can set the flash mode to match the shooting conditions.

1 Tap the flash mode icon.



2 Tap the desired flash mode icon.

- See “Available Flash Modes” (📖 55) for more information.
- To quit without changing the setting, tap the flash mode icon again. If you tap any other icon, the setting screen for that item is displayed.

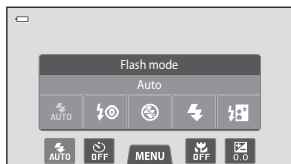

3 Frame the subject and take a picture.

- The flash indicator shows flash status when the shutter-release button is pressed halfway.
 - On: Flash will fire when the shutter-release button is pressed all the way down.
 - Blinks: Flash charging. Wait a few seconds and try again.
 - Off: Flash will not fire.
- If the battery is low, the monitor will turn off, and remain off, while the flash charges.



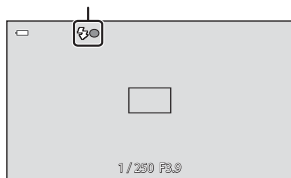



Flash indicator



Effective Range of the Flash

When ISO sensitivity is set to **Auto**, the flash has a range of 0.3-3.5 m (1 ft-11 ft) at the maximum wide-angle zoom position and a range of 0.5-2.2 m (1 ft 8 in.-7 ft 2 in.) at the maximum telephoto zoom position.

Available Flash Modes

 AUTO	Auto
	Flash fires automatically when lighting is poor.
	Auto with red-eye reduction
	Suited to pictures of people. This option reduces the “red-eye” phenomenon that caused by the use of flash.
	Off
	Flash will not fire even when lighting is poor. We recommend using a tripod to stabilize the camera when shooting in dark surroundings.
	Fill flash
	Flash fires whenever a picture is taken. Use to “fill-in” (illuminate) shadows and back-lit subjects.
	Slow sync
	 AUTO (auto) is combined with slow shutter speed. Suited to evening and night portraits that include background scenery. Flash illuminates main subject; slow shutter speeds are used to capture background at night or under dim lighting.

The Flash Mode Setting

- The flash mode setting varies with shooting mode.
See “Functions Available for Each Shooting Mode” (📖 53) for more information.
See “Default Settings” (📖 60) for more information.
- There are functions with which this setting cannot be enabled. See “Features That Cannot Be Applied Simultaneously” (📖 64) for more information.
- The flash mode setting applied in  (auto) mode (📖 37) is saved in the camera’s memory even after the camera is turned off.

Red-eye Reduction

This camera uses advanced red-eye reduction (“In-Camera Red-Eye Fix”). To reduce red-eye, a series of low-intensity pre-flashes fire before the main flash. In addition, if the camera detects red-eye when a picture is taken, the affected area is processed to reduce red-eye before the picture is saved. Note the following when shooting:

- Due to the pre-flashes, there is a longer than usual interval between the time the shutter-release button is pressed and the time the shutter is released.
- More time than usual is required to record pictures.
- Red-eye reduction may not produce the desired results in some situations.
- In extremely rare instances, areas not subject to red-eye may be affected by red-eye reduction processing; in these cases, choose another flash mode and try again.

Using the Self-timer

The camera is equipped with a ten-second and two-second timer for self-portraits. This feature is useful for reducing the effects of camera shake that occurs when pressing the shutter-release button. When using the self-timer, use of a tripod is recommended. Set **Vibration reduction** to **Off** from the setup menu (📖 88) when using a tripod to stabilize the camera.

1 Tap the self-timer icon.



2 Tap 10s or 2s.

- **10s 10 s**: Use on important occasions, such as weddings.
- **2s 2 s**: Use to prevent camera shake.
- The selected self-timer mode is displayed.
- To quit without changing the setting, tap the self-timer icon again. If you tap any other icon, the setting screen for that item is displayed.

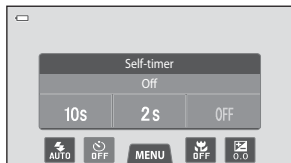

3 Frame the picture and press the shutter-release button halfway.

- Focus and exposure will be locked.



4 Press the shutter-release button the rest of the way down.

- The self-timer starts, and the number of seconds remaining before the shutter is released is displayed in the monitor. The self-timer lamp blinks while the timer is counting down. About one second before the shutter is released, the lamp stops blinking and glows steadily.
- When the shutter is released, the self-timer turns off.
- To stop the timer before a picture is taken, press the shutter-release button again.

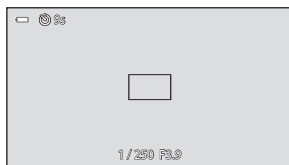

Using Macro Mode

When using macro mode, the camera can focus on objects as close as 1 cm (0.4 in.) from the front of the lens.

This feature is useful when taking close-up pictures of flowers and other small subjects.

1 Tap the macro mode icon.



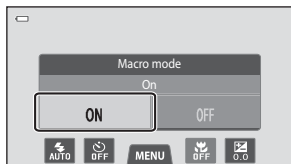

2 Tap ON.

- To quit without changing the setting, tap the macro mode icon again. If you tap any other icon, the setting screen for that item is displayed.



3 Tap **T** or **W** to set the zoom ratio to a position where and the zoom indicator glow green.

- The closest possible shooting distance may vary according to the zoom position.
- The camera can focus on subjects as close as 10 cm (4 in.) from the lens when  and the zoom indicator glow green. The camera can focus on subjects as close as 1 cm (0.4 in.) from the lens when the zoom indicator is positioned below  (wide-angle position).

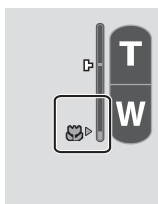

Note on Using the Flash

The flash may be unable to light the entire subject at distances of less than 50 cm (1 ft 8 in.).

The Macro Mode Setting



- Macro mode cannot be used depending on the shooting mode. See "Default Settings" (📖 60) for more information.
- The macro mode setting applied in  (auto) mode (📖 37) is saved in the camera's memory even after the camera is turned off.

Adjusting Brightness (Exposure Compensation)

Exposure compensation is used to alter exposure from the value suggested by the camera to make pictures brighter or darker.

- 1 Tap the exposure compensation icon.



- 2 Tap  or  to change the exposure compensation value.

- To make the picture brighter, apply positive (+) exposure compensation.
- To make the picture darker, apply negative (-) exposure compensation.
- You can also tap or drag the slider to change the value.

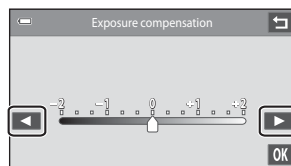

- 3 Press the shutter-release button to take a picture.

- To exit the setting screen without taking a picture, tap **OK** or .
- To cancel the exposure compensation, return to step 1, revert the value to **[0.0]**, and tap **OK**.

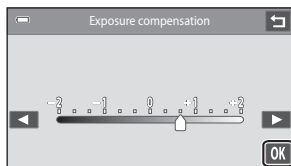











Exposure Compensation Value



The exposure compensation value applied in  (auto) mode ( 37) is stored in the camera's memory even after the camera is turned off.

Default Settings

The default settings for each function in each shooting mode are described below.

- See the next page for information about the default settings in the scene modes.

	Flash ( 54)	Self-timer ( 56)	Macro ( 58)	Exposure compensation ( 59)
 (easy auto)	 ¹ AUTO	Off	Off ²	0.0
 (auto)	 AUTO	Off	Off	0.0
 (smart portrait)	 ³ AUTO	Off ⁴	Off ⁵	0.0
 (movie)	–	Off ⁵	Off	–

¹  **AUTO** (default setting) or  **Off** can be selected. When  **AUTO** is selected, the camera automatically selects the flash mode appropriate for the scene it has selected.

² The setting cannot be changed. The camera enters macro mode when  is selected.







































³ The function cannot be used when **Blink proof** is set to **On**.

⁴ The function can be used when **Smile timer** is set to **Off**.

⁵ The setting cannot be changed.

- The setting applied in  (auto) mode is saved in the camera's memory even after the camera is turned off (except the self-timer setting).

The default settings for each function in scene mode are described below.

	Flash (📖 54)	Self-timer (📖 56)	Macro (📖 58)	Exposure compensation (📖 59)
 (📖 42)		Off	Off ¹	0.0
 (📖 42)	 ¹	Off	Off ¹	0.0
 (📖 42)	 ¹	Off ¹	Off ¹	0.0
 (📖 43)	 ²	Off	Off ¹	0.0
 (📖 43)	 ³	Off	Off ¹	0.0
 (📖 43)	 AUTO	Off	Off ¹	0.0
 (📖 43)	 AUTO	Off	Off ¹	0.0
 (📖 44)	 ¹	Off	Off ¹	0.0
 (📖 44)	 ¹	Off	Off ¹	0.0
 (📖 44)	 ¹	Off	Off ¹	0.0
 (📖 44)	 ¹	Off	On ¹	0.0
 (📖 45)	 ¹	Off	On ¹	0.0
 (📖 45)	 ¹	Off	Off	0.0
 (📖 45)	 ¹	Off ¹	Off ¹	0.0 ¹
 (📖 45)	 ¹	Off	Off	0.0
 (📖 46)	–	–	–	–
 (📖 46)	 ⁴	Off	Off ¹	0.0
 (📖 47)	 ⁵	Off ⁵	Off ⁵	0.0
 (📖 48)	 ¹	Off ¹	Off	0.0
 (📖 49)	 ¹	Off ¹	Off	0.0

¹ Cannot be changed.

² Cannot be changed. The flash mode setting is fixed at fill flash with slow sync with red-eye reduction.

³ The setting may change to slow sync with red-eye reduction.

⁴ Flash is fixed at  (fill flash) when **HDR** is set to **Off**, and is fixed at  (off) when **HDR** is set to **On**.

⁵ Cannot be changed when **Easy panorama** is selected.















◀ Changing the Image Size (Image Mode)

You can use the **Image mode** setting in the shooting menu to select the combination of image size and compression rate that is used when saving pictures.

Enter shooting mode → MENU tab → ◀ Image mode

Choose the image mode best suited to the manner in which pictures will be used and the capacity of the internal memory or memory card. The higher the image mode setting, the larger the size at which it can be printed or displayed without appearing noticeably “grainy,” but limiting the number of pictures that can be recorded.

Image Mode Settings (Image Size and Quality)

Image mode*	Description
 4608×3456 ★	Images will be higher quality than  . The compression ratio is approximately 1:4.
 4608×3456	Best choice in most situations. The compression ratio is approximately 1:8.
 4000×3000	
 3264×2448	
 2592×1944	
 2048×1536	Smaller size than  ,  ,  , or  allows more pictures to be stored. The compression ratio is approximately 1:8.
 1024×768	Suited to display on a computer monitor. The compression ratio is approximately 1:8.
 640×480	Suited to full-screen display on a television with an aspect ratio of 4:3, or distribution by e-mail or the web. The compression ratio is approximately 1:8.
 4608×2592 (default setting)	Pictures with an aspect ratio of 16:9 are recorded. The compression ratio is approximately 1:8.

* The total number of pixels recorded, and the number of pixels recorded horizontally and vertically.











Example:  **4608×3456** = Approx. 16 megapixels, 4608 × 3456 pixels

Image Mode

- Changes made to this setting apply to all shooting modes (except movie recording).
- There are functions with which this setting cannot be enabled. See “Features That Cannot Be Applied Simultaneously” (📖 64) for more information.
- Image mode cannot be selected in **Draw, 3D photography**, and **Panorama** (when **Easy panorama** is selected) scene modes (📖 40).

Number of Exposures Remaining

The following table lists the approximate number of pictures that can be stored in internal memory and on a 4 GB memory card. Note that the number of pictures that can be stored will differ depending on the composition of the picture (due to JPEG compression). In addition, this number may vary depending upon the make of memory card, even when the memory cards have the same specified capacity.

Image mode	Internal memory (approx. 71 MB)	Memory card ¹ (4 GB)	Print size (cm/in.) ²
 4608×3456★	9	490	Approx. 39 × 29/15 × 11.5
 4608×3456	18	970	Approx. 39 × 29/15 × 11.5
 4000×3000	24	1280	Approx. 34 × 25/13 × 10
 3264×2448	36	1910	Approx. 28 × 21/11 × 8
 2592×1944	56	2940	Approx. 22 × 16/8.5 × 6.5
 2048×1536	87	4640	Approx. 17 × 13/7 × 5
 1024×768	284	15000	Approx. 9 × 7/3.5 × 2.5
 640×480	505	24100	Approx. 5 × 4/2 × 1.5
 4608×2592	24	1290	Approx. 39 × 22/15 × 8.5

¹ If the number of exposures remaining is 10,000 or more, the number of exposures remaining display shows “9999.”

² Print size at an output resolution of 300 dpi. Print sizes are calculated by dividing the number of pixels by printer resolution (dpi) and multiplying by 2.54 cm (1 in.). However, at the same image size, pictures printed at higher resolutions will print smaller than the size indicated, and those printed at lower resolutions will print larger than the size indicated.

Image Mode Setting and Monitor Display

Monitor display in shooting and playback modes varies as indicated below according to the image mode setting.

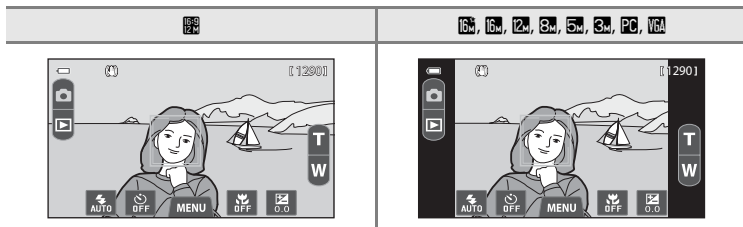

Features That Cannot Be Applied Simultaneously

Some shooting settings cannot be used with other functions.

Restricted function	Setting	Description
Flash mode (📖 54)	Continuous (📖 38)	When Continuous H , Continuous L , BSS , or Multi-shot 16 is selected, flash is disabled.
	Blink proof (📖 52)	When Blink proof is set to On , flash is disabled.
Self-timer (📖 56)	Subject tracking (📖 38)	When Touch shooting is set to Subject tracking , Self-timer is disabled.
Image mode (📖 62)	Continuous (📖 38)	When Multi-shot 16 is selected, the Image mode setting is fixed at 5M (image size: 2560 × 1920 pixels).
Macro mode (📖 58)	Subject tracking (📖 38)	When Touch shooting is set to Subject tracking , Macro mode is disabled.
ISO sensitivity (📖 38)	Continuous (📖 38)	When Multi-shot 16 is selected, the ISO sensitivity setting is automatically specified according to the brightness.
		When Continuous L is selected, 3200 cannot be selected. If Continuous L is selected when the ISO sensitivity setting is 3200 , the ISO sensitivity setting changes to 1600 .
Continuous (📖 38)	Self-timer (📖 56)	When taking a picture using the self-timer, the continuous setting is fixed to Single .
	Touch shutter (📖 38)	When using the touch shutter function, one picture is taken each time the monitor is tapped.
Blink warning (📖 89)	Continuous (📖 38)	When Continuous H , Continuous L , BSS , or Multi-shot 16 is selected, Blink warning is disabled.
Print date (📖 88)	Continuous (📖 38)	When Continuous H , Continuous L , or BSS is selected, Print date is disabled.
	Blink proof (📖 52)	When On is selected, Print date is disabled.
Digital zoom (📖 89)	Continuous (📖 38)	When Multi-shot 16 is selected, digital zoom is not available.
	Subject tracking (📖 38)	When the touch shooting is set to Subject tracking , digital zoom is disabled.

✔ Notes on Digital Zoom

- Digital zoom cannot be used depending on the shooting mode.
- The camera focuses on the subject at the center of the frame when digital zoom is in effect.

Face Detection

When the camera is pointed at a human face in the shooting modes listed below, the camera automatically detects the face and focuses on it.

When the camera detects more than one face, the double border (focus area) is displayed around the face that is focused on, and single borders around the others.

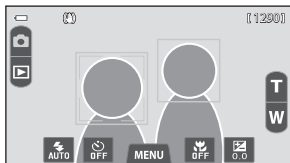



- Tap a face framed by a single border to change the focus area to that face (except when smile-timer is set to **On** in smart portrait mode).

Shooting mode	Number of faces that can be detected	Focus area (double border)
(easy auto) mode (📖 36)	Up to 12	The face closest to the camera
(auto) mode (📖 37)		
Portrait and Night portrait scene modes (📖 40)		
Smart portrait mode (📖 50)	Up to 3	The face closest to the center of the frame



- In (easy auto) mode, the camera changes focus areas depending on the scene that it automatically selects (📖 28).
- In (auto) mode, if no faces are detected when the shutter-release button is pressed halfway, the camera automatically selects one (or more) of the nine focus areas containing the subject closest to the camera.
- In **Portrait** and **Night portrait** scene modes or smart portrait mode, if no faces are detected when the shutter-release button is pressed halfway, the camera will focus on the subject at the center of the frame.
- In subject tracking mode (📖 38), subject tracking begins when a detected face framed by a border is tapped.

Notes on the Face Detection Function

- The camera may be unable to detect faces in the following situations:
 - When faces are partially hidden by sunglasses or other obstructions
 - When faces take up too much or too little of the frame
- When the frame includes more than one face, the faces detected by the camera and the face on which the camera focuses depend upon a variety of factors, including the direction in which the faces are looking.
- When shooting a subject that is not suitable for autofocus ( 29), the camera may not be able to focus properly on the subject despite the fact that the double border glows green. Should this occur, refocus on another subject positioned at the same distance from the camera as the actual portrait subject ( 39).

Viewing Pictures That Were Taken Using Face Detection

If you enlarge a picture by tapping  or tapping the face detected at the time of shooting twice quickly in full-frame playback mode, the picture is enlarged so that the detected face is displayed in the center of the monitor (except pictures taken in sequence).

If the camera detected multiple faces when the picture was taken, you can tap  or  to display a different face. Once you change the zoom ratio, you will be able to zoom in on an area of the picture where there are no faces.

Skin Softening

The camera detects up to three human faces when the shutter is released, and processes the image to soften facial skin tones before saving the image. The skin softening feature is active when using the following shooting modes.

- When shooting in **Portrait** (📖 42) or **Night portrait** (📖 43) scene mode, or when the camera selects one of these scene modes while in 📷 (easy auto) mode.
- When shooting in smart portrait mode (📖 50).
- Skin softening can also be applied to saved pictures by using the glamour retouch function (📖 73).

✔ Notes on Skin Softening

- More time than usual may be required to save a picture.
- In some shooting conditions, facial skin tones may not be smoothed or parts other than face may be modified. If the desired results are not produced, switch to another shooting mode or set **Skin softening** to **Off** if using smart portrait mode, and shoot again.
- The skin softening level cannot be adjusted when **Portrait** or **Night portrait** is selected in the scene mode.



A series of horizontal dashed lines for handwriting practice, spanning the width of the page.

Playback Features

This chapter describes how to select certain types of pictures for playback as well as some of the features available when playing back pictures.

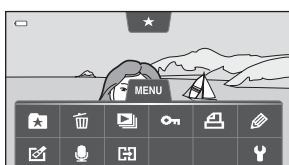
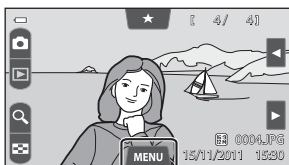
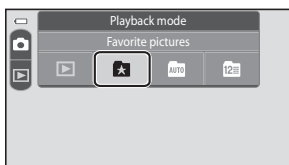
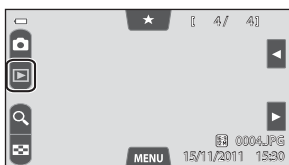

Selecting Certain Types of Pictures for Playback

You can change the playback mode according to the type of pictures you want to view.

Available Playback Modes

 **Play**  30



All pictures are played back. When you switch from shooting mode to playback mode, this mode is selected.

 **Favorite pictures**  10



Only pictures added to albums are played back.
Pictures should be added to albums before selecting this mode ( 73).

 **Auto sort**  14

Pictures are automatically sorted in to categories, such as portraits, landscapes, and movies. You can use this mode to specify a category and play back pictures in that category only.

 **List by date**  16

Only pictures taken on the same date are played back.

 **3D playback**  9

Only pictures taken in **3D photography** scene mode are output (played back) in 3D. This playback mode can be selected only when the camera is connected to a 3D-compatible TV or monitor using a 3D-compatible HDMI cable.

- Set **TV settings** in the setup menu ( 88) as follows:
 - **HDMI: Auto** (default setting) or **1080i**
 - **HDMI 3D output: On** (default setting)



Switching Between Playback Modes

1 When viewing pictures in full-frame playback mode (📖 30) or thumbnail playback mode (📖 31), tap the playback mode icon.

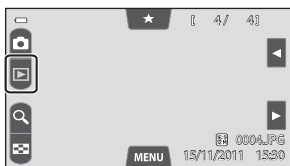
- The screen used to select a playback mode (the playback-mode selection menu) is displayed.



2 Tap the desired playback mode icon.

- If you select  (playback), the playback screen is displayed.
- When an option other than  (playback) is selected, the album, category or shooting date selection screen is displayed.
- To return to the current playback mode, tap the playback mode icon at the upper left in the monitor.

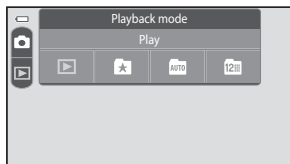

3 Tap an album, category or shooting date.

- Repeat the procedure from step 1 to select favorite pictures, auto sort, or list by date mode again.

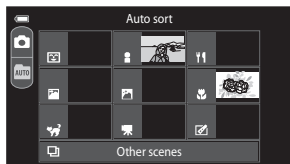

Auto sort mode

Setting the Picture Rating

If pictures have been assigned a rating of one to five, they can be played back in groups defined by rating.

- To set a rating, tap the rating tab in full-frame playback or thumbnail playback (📖 31) mode and drag and drop the desired rating icon onto a picture.
- To change the rating, drag and drop another rating icon.
- To cancel the rating, drag and drop ★0.
- While setting the ratings, drag the current picture to display the previous or next picture. It is possible to zoom or switch to thumbnail display by spreading or pinching fingers.

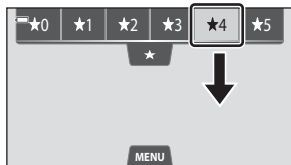

Playing Back Pictures by Rating

Tap the rating tab in full-frame playback mode or thumbnail playback mode and tap a rating icon to display the pictures with that rating.

- The icon of the tapped rating turns yellow, and only the pictures assigned with the selected rating are displayed. Multiple ratings can be selected.
- To stop displaying pictures of a selected rating, tap the icon of the rating to deselect it.
- To stop playback by rating, deselect all ratings.



✓ Notes on the Rating

- Each rating can be applied to a maximum of 999 pictures.
- The ratings applied on the COOLPIX S100 are not recognized by your computer.

Features Available in Playback Mode (Playback Menu)

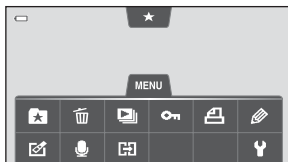

If you tap the **MENU** tab when viewing pictures in full-frame playback mode or thumbnail playback mode, the following menu options are displayed.

- Tap an icon to display the menu for that option (📖 12).



Option	Description	📖
★ Favorite pictures ^{1,2}	Add pictures to an album. In favorite pictures mode, remove pictures from an album.	👁️ 10
🗑️ Delete	Delete pictures or movies.	32
🎞️ Slide show	Play back pictures, stored in the internal memory or on a memory card, one by one in an automated slide show.	👁️ 62
🔒 Protect	Protect selected pictures from accidental deletion.	👁️ 64
🖨️ Print order ^{2,3}	When using a printer to print pictures saved on the memory card, you can use the Print order function to select which pictures are printed, and how many copies of each picture are printed.	👁️ 66
🖌️ Paint ^{1,2,3,4}	Draw on pictures or add decorations to pictures. Painted copies are stored as separate files.	👁️ 22
✍️ Retouch ^{1,2,3,4}	Edit pictures. Available editing functions are ✂️ Quick retouch , 📷 D-Lighting , 📏 Stretch , 📐 Perspective control , 🎛️ Filter effects , 🌟 Glamour retouch , and 🖼️ Small picture . Retouched copies are stored as separate files.	👁️ 20
	🔄 Rotate image is available to set the orientation of pictures when they are played back on the camera.	
🗣️ Voice memo ^{1,2}	Record, play back, and delete voice memos.	👁️ 71
📄 Copy ⁵	Copy files between a memory card and the internal memory.	👁️ 73

Features Available in Playback Mode (Playback Menu)

Option	Description	
 Choose key picture ⁶	Change the key picture for a group of pictures taken in sequence (sequence of pictures;  30).	 74

¹ When using thumbnail playback mode, this function cannot be applied. Display the picture in full-frame playback mode.

² The function cannot be used for movies.

³ The function cannot be applied to pictures taken in **3D photography** scene mode ( 49).

⁴ Copies created with editing functions other than the paint function cannot be further edited with the same function used to create them. However, some editing functions such as the paint, small picture, and cropping functions may be additionally performed.

⁵ This function is available only in  (play) playback mode.

⁶ This function is available only when pictures in a sequence are displayed individually.

Connecting the Camera to a Television, Computer, or Printer

You can enhance your enjoyment of images and movies by connecting the camera to a TV, computer, or printer.

- Before connecting the camera to an external device, make sure the remaining battery level is sufficient and close the slide cover to turn the camera off. For information about the connection methods and subsequent operations, refer to the documentation included with the device in addition to this document.

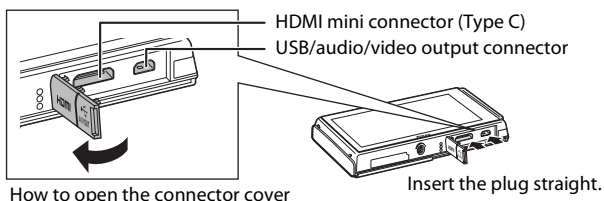

Viewing images on a TV

 35

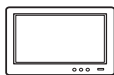

You can view the camera's images and movies on a TV.
Connection method: Connect the video and audio plugs of the included Audio Video Cable EG-CP16 to the TV's input jacks. Alternatively, connect a commercially available HDMI cable (Type C) to the TV's HDMI input jack.

Viewing and organizing images on a computer

 76



If you transfer images to a computer, you can perform simple retouching and manage image data in addition to playing back images and movies.
Connection method: Connect the camera to the computer's USB input jack with the included USB Cable UC-E6.

- Before connecting to a computer, install ViewNX 2 on the computer using the included ViewNX 2 Installer CD-ROM. For information about using the ViewNX 2 Installer CD-ROM and transferring images to a computer, see page 78.
- If any USB devices that draw the power from the computer are connected, disconnect them from the computer before you connect the camera to it. Connecting the camera and other USB-powered devices to the same computer simultaneously may cause a camera malfunction or excessive power supply from the computer, which could damage the camera or memory card.

Printing images without using a computer

 38



If you connect the camera to a PictBridge-compatible printer, you can print images without using a computer.
Connection method: Connect the camera directly to the printer's USB input jack with the included USB Cable UC-E6.

Using ViewNX 2

ViewNX 2 is an all-in-one software package which enables you to transfer, view, edit and share images.

Install ViewNX 2 using the ViewNX 2 Installer CD-ROM.



Installing ViewNX 2

- An Internet connection is required.

Compatible Operating Systems

Windows

- Windows 7 Home Basic/Home Premium/Professional/Enterprise/Ultimate
- Windows Vista Home Basic/Home Premium/Business/Enterprise/Ultimate (Service Pack 2)
- Windows XP Home Edition/Professional (Service Pack 3)

Macintosh

- Mac OS X (version 10.5.8, 10.6.7)

Refer to the Nikon website for the latest information on operating system compatibility.

1 Start the computer and insert the ViewNX 2 Installer CD-ROM into the CD-ROM drive.

- Mac OS: When the **ViewNX 2** window is displayed, double-click the **Welcome** icon.

2 Select a language in the language selection dialog to open the installation window.

- If the desired language is not available, click **Region Selection** to choose a different region and then choose the desired language (the **Region Selection** button is not available in the European release).
- Click **Next** to display the installation window.

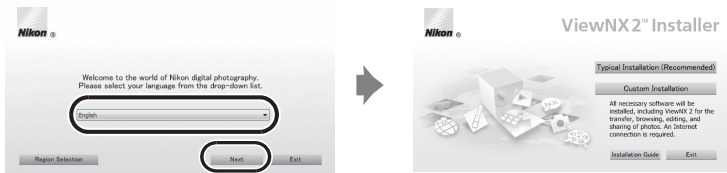

3 Start the installer.

- We recommend clicking **Installation Guide** in the installation window to check the installation help information and system requirements before installing ViewNX 2.
- Click **Typical Installation (Recommended)** in the installation window.

4 Download the software.

- When the **Software Download** screen is displayed, click **I agree - Begin download**.
- Follow the on-screen instructions to install the software.

5 Exit the installer when the installation completion screen is displayed.

- Windows: Click **Yes**.
- Mac OS: Click **OK**.

The following software is installed:

- ViewNX 2 (consisting of the three modules below)
 - Nikon Transfer 2: For transferring images to the computer
 - ViewNX 2: For viewing, editing, and printing transferred images
 - Nikon Movie Editor: For basic editing of transferred movies
- Panorama Maker 5 (for creating a single panorama photo using a series of images shot in panorama assist scene mode)
- QuickTime (Windows only)

6 Remove the ViewNX 2 Installer CD-ROM from the CD-ROM Drive.

Transferring Images to the Computer

1 Choose how images will be copied to the computer.

Choose one of the following methods:

- **Direct USB connection:** Close the slide cover to turn the camera off and ensure that the memory card is inserted in the camera. Connect the camera to the computer using the supplied USB Cable UC-E6. The camera automatically turns on.

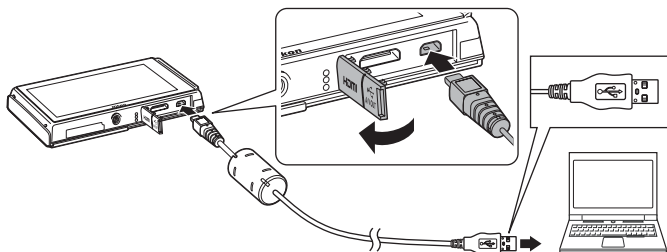

- **SD card slot:** If your computer is equipped with an SD card slot, the card can be inserted directly in the slot.
- **SD card reader:** Connect a card reader (available separately from third-party suppliers) to the computer and insert the memory card.

If a message is displayed prompting you to choose a program, select Nikon Transfer 2.

• When using Windows 7

If the dialog shown at right is displayed, follow the steps below to select Nikon Transfer 2.

- 1 Under **Import pictures and videos**, click **Change program**. A program selection dialog will be displayed; select **Import File using Nikon Transfer 2** and click **OK**.
- 2 Double-click **Import File**.



If the memory card contains a large number of images, it may take a while for Nikon Transfer 2 to start. Wait until Nikon Transfer 2 starts.

✓ Connecting the USB Cable

The connection may not be recognized if the camera is connected to the computer via a USB hub.

2 Transfer images to the computer.

- Confirm that the name of the connected camera or removable disk is displayed in the “Source” panel in the Nikon Transfer 2 “Options” area (①).
- Click **Start Transfer** (②).

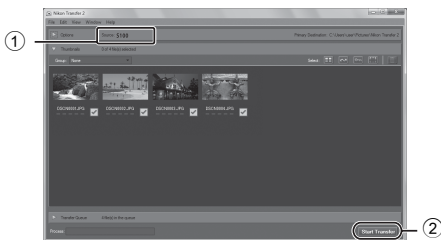

- At default settings, all the images on the memory card will be copied to the computer.

3 Terminate the connection.

- If the camera is connected to the computer, open the slide cover and close it again to turn the camera off, and disconnect the USB cable. If you are using a card reader or card slot, choose the appropriate option in the computer operating system to eject the removable disk corresponding to the memory card and then remove the card from the card reader or card slot.

Viewing Images

Start ViewNX 2.

- Images are displayed in ViewNX 2 when transfer is complete.
- Consult online help for more information on using ViewNX 2.

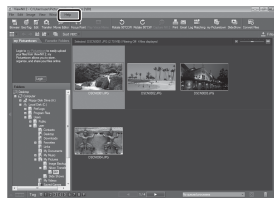

Starting ViewNX 2 Manually

- **Windows:** Double-click the **ViewNX 2** shortcut on the desktop.
- **Mac OS:** Click the **ViewNX 2** icon in the Dock.

Retouching Photographs

Click **Edit** in the ViewNX 2 toolbar.

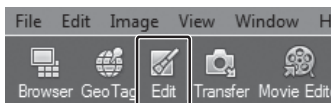

Image editing functions include tone compensation, sharpness adjustment, and trimming (cropping).

Editing Movies

Click **Movie Editor** in the ViewNX 2 toolbar.



Movie editing functions include the ability to delete unwanted scenes.

Printing Images

Click **Print** in the ViewNX 2 toolbar.

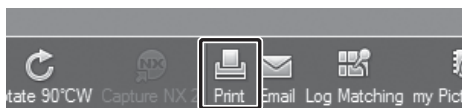

A dialog is displayed and images can be printed using a printer connected to the computer.

Recording and Playing Back Movies

You can record movies by setting the shooting mode to **Movie**.

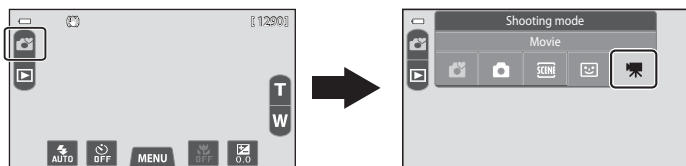

In playback mode, tap  to play a movie.

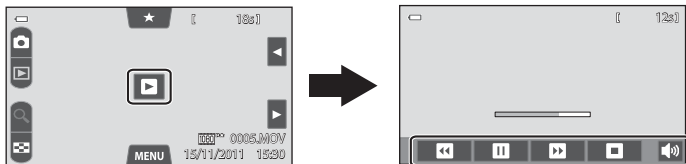

Recording Movies

Record movies with sound.

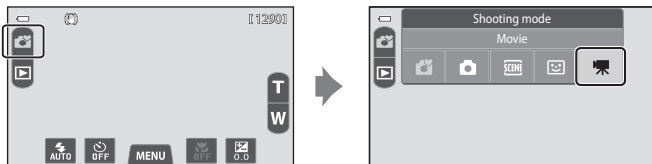

- Each movie is limited to a file size of 4 GB and a movie length of 29 minutes, even when there is sufficient free space on the memory card for longer recording (📖 84).

1 Press the shutter-release button all the way down to start recording.

- The camera focuses at the center of the frame. Focus areas are not displayed during recording.
- Recording stops automatically when the maximum movie length that can be recorded has run out.

Movie recording time remaining



Movie Recording Time Remaining

The approximate remaining recording time is displayed during recording.

- If a memory card is not inserted, **IN** is displayed to indicate that the movie will be saved in the camera's internal memory (approximately 71 MB).
- The remaining recording time shown in the illustrations differs from the actual display.

2 Press the shutter-release button all the way down to end recording.

- Movie recording can also be started or stopped by tapping the monitor. See “Touch shooting” (📖 85) for more information.

✔ Note on Saving Movies

After a movie has been recorded, it is not fully saved to the internal memory or memory card until the monitor display returns to the shooting display. **Do not open the battery-chamber/memory card slot cover** before movies have been fully saved. Removing the memory card while movies are being saved could result in loss of data or in damage to the camera or card.

Recording Movies

- Memory cards with an SD Speed Class rating of 6 or faster are recommended when recording movies (📖 19). Movie recording may stop unexpectedly when memory cards with a lower Speed Class ratings are used.
- The camera focuses when the shutter-release button is pressed halfway, and the focus remains locked while the shutter-release button is pressed halfway. Focus is locked while recording.
- Digital zoom degrades picture quality. When recording movies, the digital zoom can magnify the image up to 4× the maximum optical zoom ratio.
- In some cases, movie recordings may capture the sounds of the camera, such as the sounds produced by the shutter-release button, the zoom control operation, the movement of the lens during autofocus, or the aperture control when the brightness changes.
- The following phenomena may be seen in the monitor while recording movies. These phenomena are saved in the recorded movies.
 - Banding may occur in images under fluorescent, mercury-vapor, or sodium-vapor lighting.
 - Subjects that move quickly from one side of the frame to the other, such as a moving train or car, may appear skewed.
 - The entire movie image may be skewed when the camera is panned.
 - Lighting or other bright areas may leave residual images when the camera is moved.
- When recording or playing back movies, colored stripes (interference patterns or moiré) may appear on subjects that have a regular, repeating grid, such as pattern of weave in cloths or windows in a building, depending on the shooting distance or zoom ratio. This phenomenon occurs when the subject's pattern interferes with the camera sensor grid, and it does not indicate a malfunction.

Notes on Camera Temperature



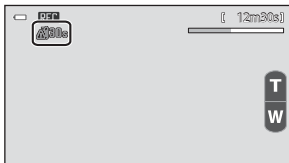

- The camera temperature may increase significantly when used for an extended period of time for movie recording, etc. or when used in places with high ambient temperature.
- If the camera becomes extremely hot while recording a movie, the camera automatically terminates recording. The camera monitor displays the number of seconds remaining until automatic termination is activated. Five seconds after movie recording is terminated, the monitor turns off and the camera enters standby mode. Close the slide cover to turn off the camera, and wait until the internal temperature decreases before using it again.



Notes on Autofocus for Movie Recording

- When **AF-S Single AF** (default setting) is selected for **Autofocus mode** in movie menu, focus is locked when recording starts.
 - When shooting a subject that is not suitable for autofocus (📖 29), the camera may not be able to focus properly on the subject. Follow the procedure below if you are trying to shoot this type of subject for movies.
1. Set **Autofocus mode** in the movie menu to **AF-S Single AF** (default setting) before starting movie recording.
 2. Frame a different subject (positioned at the same distance from the camera as the intended subject) in the center of the frame, press the shutter-release button halfway, modify the composition, and press the shutter-release button all the way down.

 **Maximum Movie Length**

Movie options (📖 85)	Internal memory (approx. 71 MB)	Memory card (4 GB)*
 HD 1080p★ (1920×1080) (default setting)	40 s	35 min
 HD 1080p (1920×1080)	45 s	40 min
 HD 720p (1280×720)	1 min 5 s	55 min
 iFrame 540 (960×540)	20 s	20 min
 VGA (640×480)	3 min 15 s	2 h 50 min

All figures are approximate. The maximum movie length may vary by make of memory card.

* Each movie is limited to a file size of 4 GB and a movie length of 29 minutes, even when there is sufficient free space on the memory card for longer recording. The maximum movie length that can be recorded for a single movie is displayed during recording.

Changing Movie Recording Settings

- You can change macro mode. See “Basic Shooting Settings” (📖 53) for more information.
- If you tap the **MENU** tab (📖 11), the menu options available for movie recording are displayed. See “Movie Menu Options” (📖 85) for more information.

Movie Menu Options

The following options can be changed when recording movies.

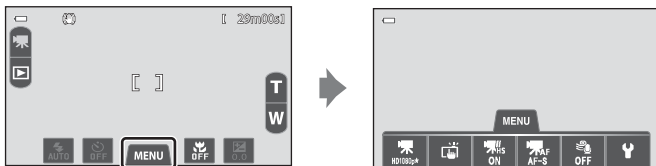

Option	Description	
Movie options	Select the movie type. <ul style="list-style-type: none"> Select either normal speed movies or HS (high speed) movies, which enable slow motion or fast motion playback. To record HS movies, select an HS movie option. 	📖 75
Touch shooting	Select ON (default setting) or OFF to activate or deactivate the touch shutter.	📖 49
Open with HS footage	When you select an HS movie option in Movie options , select whether or not the camera records HS movies (slow motion or fast motion movies) when movie recording starts. <ul style="list-style-type: none"> If you intend to switch between HS movie recording and normal speed movie recording while recording movies, set this option to Off and tap the HS movie switch icon at the bottom left of the monitor. 	📖 77
Autofocus mode	Select between AF-S Single AF (default setting), which locks focus when movie recording starts, and AF-F Full-time AF , which continue focusing during movie recording. <p>When Full-time AF is selected, the sound of the camera focusing may be heard in the recorded movie. If you are concerned about the sound caused, use of Single AF is recommended.</p> <ul style="list-style-type: none"> When an HS movie option is selected in Movie options, the setting is fixed to Single AF. 	📖 77
Wind noise reduction	Select whether wind noise is reduced when recording movies. <ul style="list-style-type: none"> When an HS movie option is selected in Movie options, the setting is fixed to Off. 	📖 78

Movie Playback

Select the desired movie in playback mode (📖 30) and tap .

- Movies can be recognized by the movie options icons displayed on them.
- The movie is played back.
- To adjust the volume before playback, tap the **MENU** tab and tap .









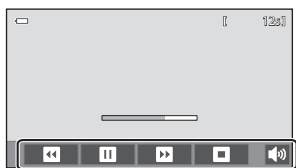









Movie option

Operations During Movie Playback

Tap the monitor during playback to display the control panel at the bottom of the monitor. The operations described below are available by tapping the icons in the panel.



To	Tap	Description
Adjust volume		Tap  to adjust the volume.
Rewind		Touch and hold  to rewind movie.
Advance		Touch and hold  to advance movie.
Pause		Pause playback. The following operations can be performed while playback is paused.
		 Rewind movie back one frame. Touch and hold  for continuous frame-by-frame rewind.
		 Advance movie forward one frame. Touch and hold  for continuous frame-by-frame advance.
		 Tap  at the center of the monitor to resume playback.
 Tap  to cut out unwanted portions of a movie and save the desired portion (movie editing).		
End		End playback and return to full-frame display.

Note on Movie Playback

Movies recorded by a camera other than the COOLPIX S100 cannot be played back.

Deleting Movie Files

See “Step 6 Delete Unwanted Pictures” (📖 32) for more information.

General Camera Setup

This chapter describes the various settings that can be adjusted in the  setup menu.

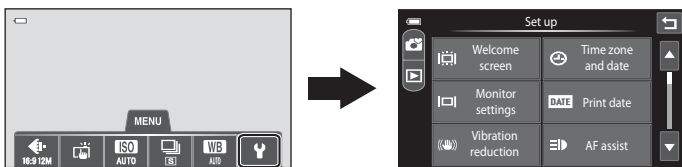

- See “Using Menus (MENU Tab)” ( 11) for information about using the camera’s menus.





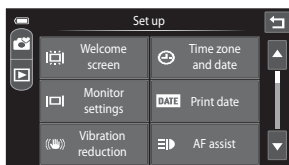
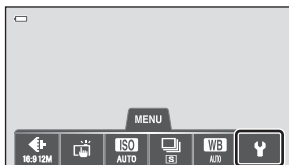

The Setup Menu

In the setup menu, the following options can be changed.















- See “Using Menus (MENU Tab)” (📖 11) for more information.
- Tap or to scroll through the display.

Option	Description	
Welcome screen	Allows you to select the picture displayed as the welcome screen when the camera is turned on. Select COOLPIX to display the COOLPIX logo. Select Select an image to use a picture taken with the camera as the welcome screen.	79
Time zone and date	Allows you to set the settings related to the camera's date and time. The Time zone setting allows you to specify the time zone where the camera is mainly used and whether or not daylight saving time is in effect. When the travel destination () is selected, the camera automatically calculates the time difference between the travel destination and the home time zone () and saves pictures using the date and time of the travel destination.	80
Monitor settings	Set the information display setting, the image review setting, and the monitor brightness.	83
Print date	Allows you to imprint the shooting date and time on pictures at the time of shooting. <ul style="list-style-type: none"> • The shooting date and time cannot be imprinted on pictures in the following situations: <ul style="list-style-type: none"> - When using Sports, Museum, Backlighting (when HDR is set to On), Panorama, Pet portrait (when Continuous is selected), or 3D photography scene mode. - When On is selected for Blink proof (📖 52) in smart portrait mode. - When Continuous H, Continuous L, or BSS is selected for the continuous setting (📖 38). - When shooting movies. 	84

Option	Description	
 Vibration reduction	<p>Allows you to reduce blurring caused by camera shake when shooting.</p> <ul style="list-style-type: none"> When using a tripod to stabilize the camera during shooting, set this feature to Off. The current vibration reduction setting can be confirmed in the camera monitor when shooting. When Off is selected, no icon is displayed. 	 85
 AF assist	<p>When set to Auto, the AF-assist illuminator ( 2) lights when shooting in dark surroundings to help the camera focus.</p> <ul style="list-style-type: none"> The illuminator has a range of about 5 m (16 ft). Even if Auto is selected, the AF-assist illuminator may not light depending on the position of the focus area or the scene mode that is selected. 	 86
 Digital zoom	<p>When set to On, tapping  at the maximum optical zoom position ( 27) triggers the digital zoom feature.</p>	 86
 Sound settings	<p>Allows you to turn various camera sounds on and off.</p>	 87
 Auto off	<p>Allows you to set the amount of time that passes before the monitor turns off to save power.</p>	 88
 Format memory/Format card	<p>Allows you to format the internal memory (only when a memory card is not inserted) or the memory card (when a memory card is inserted).</p> <ul style="list-style-type: none"> All data stored in the internal memory or on the memory card is deleted during formatting and cannot be restored. Be sure to transfer important pictures to a computer and save them before formatting. 	 89
 Language	<p>Allows you to change the camera's display language.</p>	 90
 TV settings	<p>Adjust settings for connection to television.</p> <ul style="list-style-type: none"> When the camera is connected to a television using an audio/video cable but no picture is displayed on the television, set Video mode to NTSC or PAL according to the type of signal compatible with the television. HDMI settings can be set. 	 91

The Setup Menu

Option	Description	
 Charge by computer	When set to Auto , you can charge the camera's battery by connecting the camera to a computer (provided that the computer is able to supply power). <ul style="list-style-type: none">• When charging by computer, it takes more time to charge the battery than when using the Charging AC Adapter EH-69P. Additionally, when charging by computer and transferring pictures to the computer, it takes more time to charge the battery.	 92
 Blink warning	Immediately after taking a picture using face detection ( 65) (except when using smart portrait mode), if the camera detects a subject with closed eyes, the camera displays the message Did someone blink? , allowing you to check the picture.	 93
 Sequence display options	Allows you to select whether to display only the key picture for a sequence of pictures taken continuously or to display the sequence as individual pictures.	 94
 Reset all	Allows you to reset the camera's settings to their default values. <ul style="list-style-type: none">• Certain settings such as Time zone and date and Language are not reset.	 95
 Firmware version	View the current camera firmware version.	 97



Reference Section

The Reference Section provides detailed information and hints for using the camera.

Shooting

Using the Draw Option	2
Using Easy Panorama (Shooting and Playback)	3
Using Panorama Assist	6
Taking 3D Pictures	8

Playback

Favorite Pictures Mode	10
Auto Sort Mode	14
List by Date Mode	16
Playing and Deleting Pictures Taken Continuously (Sequence)	17
Editing Pictures (Still Pictures)	20
Connecting the Camera to a TV (Playback on a TV)	35
Connecting the Camera to a Printer	38

Movies

Recording Movies in Slow Motion and Fast Motion (HS Movie)	44
Editing Movies	47

Menu

The Shooting Menu (for (Auto) Mode)	49
The Smart Portrait Menu	61
The Playback Menu	62
The Movie Menu	75
The Setup Menu	79

Additional Information

File and Folder Names	98
Optional Accessories	99
Error Messages	100









Using the Draw Option

Write a memo, or draw a picture, on the touch panel display and save it as an image. The image is saved at an image mode setting of **VGA** (640 × 480).

1 Set the shooting mode to **Draw**.

- See “Scene Mode (Shooting Suited to the Scene)” (📖 40) for information about setting the shooting mode to **Draw**.

2 Write a memo or draw pictures.

- Tap  (pen) to write text or draw pictures (🔑 23).
- Tap  (eraser) to erase text or pictures (🔑 23).
- Tap  to display the image in full-frame playback mode and tap  again to enlarge the image display by 3x. Tap , , , or  to change the portion of the image visible in the monitor. Tap  to return to the original display size.



3 Tap **OK**.

- Tap , before tapping **OK**, to undo the last operation applied using the pen or erase tool (up to the last five operations can be undone).

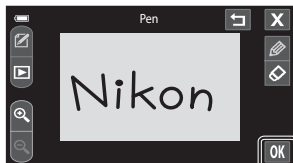

4 Tap **Yes**.

- The memo is saved.
- If you tap **No**, the monitor display return to the previous screen.

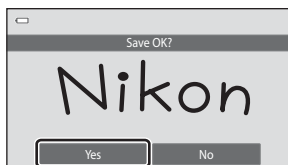

5 Tap **X**.

- The draw scene mode is exited and the monitor display returns to the shooting-mode selection menu.
- If you tap **X** when a drawing has not been saved, a confirmation dialog is displayed. Tap **Yes** to quit without saving the drawing.

Using Easy Panorama (Shooting and Playback)

Shooting with Easy Panorama

- 1 Tap the **MENU** tab in **Panorama** scene mode.
 - See “Scene Mode (Shooting Suited to the Scene)” (📖 40) for information about setting the shooting mode to **Panorama**.



- 2 Tap  and tap **EASY**.
 - Select the shooting range from **STD Normal (180°)** (default setting) and **WIDE Wide (360°)**.
See “Changing the Shooting Range” (📖 4) for more information.

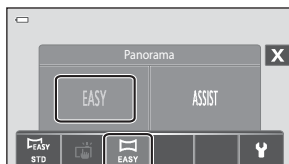

- 3 Frame the first edge of the panorama scene, and then press the shutter-release button halfway to focus.
 - The zoom position is fixed at the maximum wide-angle position.
 - A grid is displayed in the monitor.
 - The camera focuses at the center of the frame.
 - Exposure compensation (📖 59) can be set.
 - If focus and exposure cannot be set on the main subject, try focusing on another subject positioned at the same distance from the camera as the intended subject (📖 39).

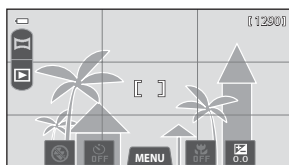

- 4 Press the shutter-release button all the way down, and then remove your finger from the shutter-release button.
 -  is displayed to indicate the direction of the camera movement.



5 Move the camera slowly and straight in one of the four directions, and begin shooting.

- When the camera detects which direction it is moving in, shooting begins.
- A guide indicating the current shooting position is displayed.
- When the shooting position guide reaches the edge, shooting ends.

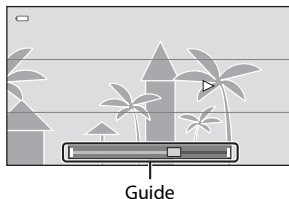

Example of Camera Movement

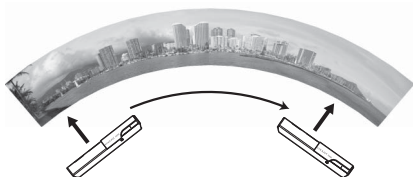

- The operator, without shifting position, moves the camera horizontally or vertically in an arc so that the guide travels from one edge to the other.
- Shooting stops if the guide does not reach the edge within about 15 seconds (when **STD Normal (180°)** is selected) or within about 30 seconds (when **WIDE Wide (360°)** is selected) after shooting starts.

✓ Notes on Easy Panorama Shooting

- The range of the image seen in the saved picture will be narrower than that seen in the monitor at the time of shooting.
- If the camera is moved too quickly or shaken too much, or if the subject is too uniform (e.g. walls or darkness), an error may occur.
- If shooting is stopped before the camera reaches the half-way point in the panorama range, a panorama picture is not saved.
- If more than half of the panorama range is captured but shooting ends before reaching the edge of the range, the range not captured is recorded and displayed in gray.

✎ Changing the Shooting Range

- When using easy panorama, tap the **MENU** tab, tap **EASY**, and tap either **STD Normal (180°)** or **WIDE Wide (360°)**.
- When the camera is held in the horizontal position during shooting, the image size (width × height) is as follows.
 - **Normal (180°)**: 3200 × 560 when moved horizontally, 1024 × 3200 when moved vertically
 - **Wide (360°)**: 6400 × 560 when moved horizontally, 1024 × 6400 when moved vertically
 - When the camera is held in the vertical position during shooting, the direction and the width and height are switched.

Playing Pictures Taken with Easy Panorama (Scroll Playback)

If you switch to playback mode (📖 30) and display a picture taken using easy panorama in full-frame playback, 🎬 is displayed.

Tap 🎬 to display the short edge of the picture using the entire monitor and automatically move (scroll) the displayed area.

- The picture scrolls in the direction that was used when shooting.

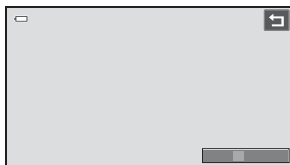
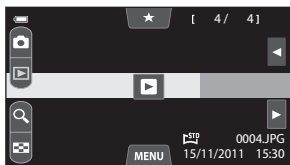

The operations listed below can be performed using the camera's touch panel.

To	Operation	
Pause	Tap the monitor to pause scrolling.	
	Manual scrolling	While paused, drag your finger across the monitor (📖 4) to scroll through the displayed picture.
	Resume automatic scrolling	While paused, tap the monitor to resume automatic scrolling.
End	Tap 🎬.	

✔ Note on Easy Panorama Scroll Playback

The COOLPIX S100 may not be able to scroll the playback of, or zoom in on, easy panorama pictures taken with another make or model of digital camera.

Using Panorama Assist

The camera focuses on the subject at the center of the frame. Use a tripod for best results. Set **Vibration reduction** to **Off** from the setup menu (📖 88) when using a tripod to stabilize the camera.

1 Tap the **MENU** tab in **Panorama** scene mode.

- See “Scene Mode (Shooting Suited to the Scene)” (📖 40) for information about setting the shooting mode to **Panorama**.

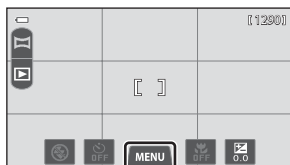



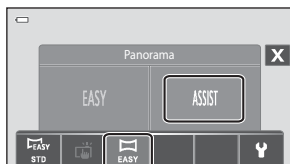

2 Tap and tap **ASSIST**.

- The panorama direction icons are displayed to show the direction in which pictures will be joined.



3 Tap a direction icon.

- Select the direction in which picture will be joined in the completed panorama; right () , left () , up () , or down () .
- A different direction can be selected by tapping a different panorama direction icon.
- Change shooting settings (📖 37) before the first picture is taken in the next step.



4 Frame the first portion of the panorama scene and take the first picture.

- One third of the picture will be displayed as translucent.



5 Take the next picture.

- Frame the next picture so that one-third of the frame overlaps the previous picture.
- Repeat this process until the necessary number of pictures have been taken to complete the scene.



6 Tap **X** when shooting is completed.

- The camera returns to step 3.



Notes on Panorama Assist

- Apply the flash mode, self-timer, macro mode, and exposure compensation settings before releasing the shutter for the first picture. Shooting settings cannot be changed after the first picture is taken. **Image mode** (📖 62) and **Touch shooting** (🔗 49) settings cannot be changed and pictures cannot be zoomed or deleted until the series is finalized.
- The panorama series is terminated if the camera enters standby mode with the auto off function (🔗 88) during shooting. Setting the time allowed to elapse before the auto off function is enabled to a longer setting is recommended.

AE/AF-L Indicator

In **Panorama assist** scene mode, exposure, white balance, and focus for all pictures in a panorama are fixed at the values for the first picture in each series.

When the first picture is taken, **AE/AF-L** is displayed to indicate that exposure, white balance, and focus are locked.



Panorama Creation with Panorama Maker 5

- Transfer a series of pictures taken in **Panorama assist** scene mode to a computer (📖 78) and create a single panorama photo with Panorama Maker 5.
- Panorama Maker 5 can be installed on a computer using the included ViewNX 2 Installer CD (📖 76).
- After installation is complete, follow the procedure described below to start Panorama Maker 5.

Windows

Choose **Start** menu > **All Programs** > **ArcSoft Panorama Maker 5** > **Panorama Maker 5**.

Mac OS X

Open **Applications** and double-click the **Panorama Maker 5** icon.

- For more information on using Panorama Maker 5, refer to the on-screen instructions and help information contained in Panorama Maker 5.

More Information

See "File and Folder Names" (🔗 98) for more information.

Taking 3D Pictures

The camera takes one picture for each eye to simulate a three-dimensional image on a 3D-compatible TV or monitor.

- The two captured images are saved as a 3D picture (MPO file) consisting of the left and right eye images. The first image (the left eye image) is also saved as a JPEG file.
- Pictures taken in this mode are saved at an image size of  (1920 × 1080).

1 Set the shooting mode to 3D photography.

- See “Scene Mode (Shooting Suited to the Scene)” (📖 40) for information about setting the shooting mode to **3D photography**.

2 Frame the subject and release the shutter.

- The camera focuses at the center of the frame. The focus area can be changed with the touch shutter or touch AF/AE option (📖 38).
- The focus, exposure, and white balance are locked after the first shot, and **AE/AF-L** is displayed on the monitor.
- The first picture is taken, and a translucent guide for taking the second picture is displayed in the frame.

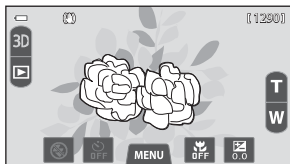

3 Move the camera horizontally to the right until the guide is aligned with the subject.

- To cancel shooting, tap **X**.

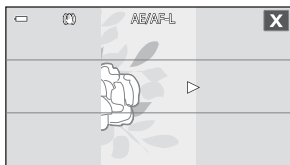

4 Wait for the camera to release the shutter with the subject aligned with the guide.

- The camera automatically takes the second picture when it detects that the subject is aligned with the guide.
- Shooting is canceled if the subject is not aligned with the guide within ten seconds.

Connecting the COOLPIX S100 to a TV or Monitor for Playing 3D Pictures.

- 3D pictures taken on this camera can be played back in 3D only on a 3D-compatible TV or monitor.
- 3D pictures cannot be played back in 3D on the camera monitor. Only the left eye image of a 3D picture is displayed during playback.

1 Set **HDMI 3D output** (🎮 91) to **On** (default setting) in **TV settings** in the setup menu (📖 88).

2 Connect the camera to a 3D-compatible TV or monitor using a 3D-compatible HDMI cable (🎮 35).

- Refer to the documentation included with the TV or monitor for details on how to make the settings.

3 Set the playback mode to **3D playback** (📖 70)

- Only 3D pictures are played back and output.
- Playback zoom is not possible.
- 3D pictures are output (played back) in 3D even when **3D playback** is not selected. However, it may take a while to display pictures when switching between 3D pictures and non-3D pictures.

🚫 Caution for Viewing 3D Pictures

- To play back 3D pictures in 3D on a 3D-compatible TV or monitor via HDMI connection, a 3D-compatible HDMI cable is required.
- Set **HDMI** (🎮 91) in **TV settings** in the setup menu (📖 88) to **Auto** (default setting) or **1080i**. If you select **480p** or **720p**, pictures cannot be played back in 3D and **3D playback** (📖 70) cannot be selected.
- When viewing 3D pictures on a 3D-compatible TV or monitor for an extended period of time, you may experience discomfort such as eye strain or nausea. Carefully read the documentation included with your TV or monitor to ensure proper use.

📝 Taking 3D Pictures

- Moving subjects are not suited to 3D photography. We recommend shooting still subjects.
- Pictures have a less pronounced 3D feel as the distance between the camera and background is increased.
- Pictures may have a less pronounced 3D feel when the subject is dark or when the second picture is not aligned precisely.
- Be careful of camera shake when shooting with a high zoom ratio.
- Pictures taken under dim lighting may appear grainy with noise.
- The angle of view (i.e., the area visible in the frame) seen in the saved picture will be narrower than that seen in the monitor at the time of shooting.
- If the camera does not take the second picture and cancels the shooting even when you align the guide with the subject, try shooting with the shutter-release button or touch shutter.

Favorite Pictures Mode

You can sort your favorite pictures into nine albums (this option is not available for movies).

Once they are added, you can choose to play back only favorite pictures by selecting favorite pictures mode (📖 71).

- Categorizing albums by theme or type of subject makes it easier to find a particular picture.
- A single picture can be added to multiple albums.
- Up to 200 pictures can be added to each album.

Adding Pictures to Albums

- 1** Display the desired picture in full-frame playback mode and tap the **MENU** tab.

- In favorite pictures mode, pictures cannot be added to albums.

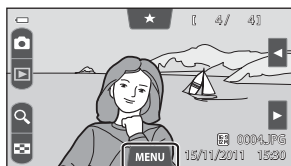

- 2** Tap **+**.

- The favorite pictures screen is displayed.

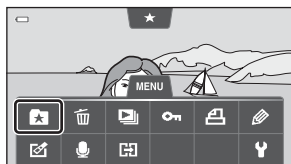

- 3** Tap the desired album.

- The picture is added to the selected album, and the monitor display returns to the favorite pictures screen.
- You can repeatedly add the same picture to other albums by tapping them.
- Drag the current picture to change the picture to add.
- Tap **+** to finish adding pictures.

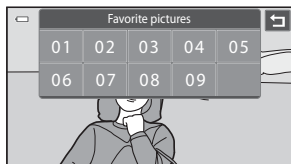

Viewing Pictures in an Album

If you tap  **Favorite pictures** using the procedure described in “Switching Between Playback Modes” (📖 71), the album selection screen is displayed.

Tap an album to play back only the pictures added to that album.

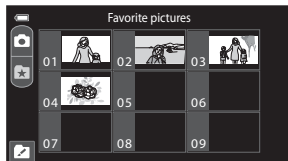

- If you tap  on the album selection screen, you can change the album icons (their colors and shapes) (🕒 13).
- If you tap the **MENU** tab in full-frame or thumbnail playback mode, you can select the playback options (📖 73).

Notes on Deleting Picture in Favorite Pictures Mode

- When pictures are added to albums, they are not physically copied to albums or moved from the folder to which they were originally recorded. Only the file names of pictures are added to albums. In favorite pictures mode, the pictures corresponding to the file names in the specified album are played back.
- Deleting a picture in favorite pictures mode deletes not only the picture from the album, but also deletes the picture file from the internal memory or memory card permanently.
- See “Removing Pictures from Albums” (🕒 12) for more information.

Removing Pictures from Albums

1 Select and play back the album containing the picture you want to remove (👁️ 11).

2 Display the picture that you want to remove, tap the **MENU** tab, and tap **★**.

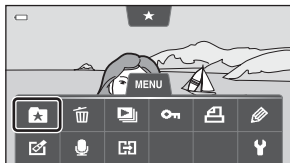

3 When the favorite pictures removal screen is displayed, tap **Yes** to remove the picture from the album.

- To exit without removing the picture, tap **No**.

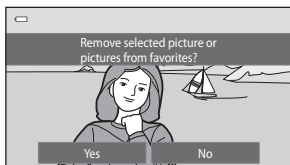

Changing Icons Assigned to Albums

The color and design of the icon assigned to an album can be changed to reflect the theme of pictures included in the album.

1 In the album selection screen (📷 11), tap .

- The album icon and icon color selection screen is displayed.

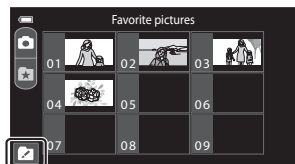

2 Tap the desired icon, tap or drag the slider to select the icon's color, and tap **OK**.

- The album selection screen is displayed.

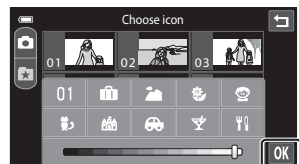

3 Tap the desired album.

- The icon is changed.
- To select a different icon and color again, tap  before tapping the album.

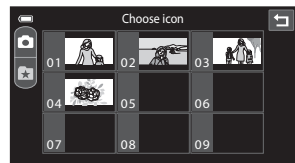

Notes on Icons for Albums

Choose icons for albums separately for the internal memory and for every memory card used.

- To change the icon for an album containing pictures stored in the internal memory, remove the memory card from the camera.
- The default setting for icons are numbers.

Auto Sort Mode





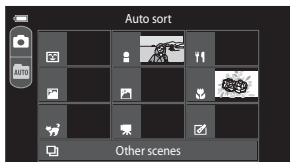







Pictures are automatically sorted into categories, such as portraits, landscapes, and movies.

If you tap  **Auto sort** using the procedure described in “Switching Between Playback Modes” (📖 71), the category selection screen is displayed. Tap a category to play back pictures in the selected category.



- If you tap the **MENU** tab in full-frame or thumbnail playback mode, you can select the playback options (📖 73).

Auto Sort Mode Categories



Category	Description
 Smile	Pictures taken in smart portrait mode (📖 50) with the smile timer setting set to On .
 Portraits	Pictures taken in  (auto) mode (📖 37) with the face detection. Pictures taken in Portrait* , Night portrait* , Party/indoor , and Backlighting* scene modes (📖 40). Pictures taken in smart portrait mode (📖 52) with the smile timer setting set to Off .
 Food	Pictures taken in Food scene mode (📖 40).
 Landscape	Pictures taken in Landscape* scene mode (📖 40).
 Dusk to dawn	Pictures taken in Night landscape* , Sunset , Dusk/dawn , and Fireworks show scene modes (📖 40).
 Close-ups	Pictures taken in  (auto) mode with the macro mode setting (📖 58). Pictures taken in Close-up* scene mode (📖 40).
 Pet portrait	Pictures taken in Pet portrait scene mode (📖 48).
 Movie	Movies (📖 82). Movies created using the movie editing function (📖 47).
 Retouched copies	Copies created using editing functions (📖 73).
 Other scenes	All other pictures that cannot be defined by the categories described above.



* Pictures taken in  (easy auto) mode (📖 36) are also sorted to the appropriate categories.

 **Notes on Auto Sort Mode**

- Up to 999 pictures and movie files can be sorted to each category in auto sort mode. If 999 pictures or movies have already been sorted to a specific category, new pictures and movies cannot be sorted to that category nor can they be displayed in auto sort mode. Display pictures and movies that could not be sorted to a category in normal playback mode (📖 30) or list by date mode (👁️ 16).
- Pictures or movies copied from the internal memory or the memory card or vice versa cannot be displayed in auto sort mode.
- Pictures or movies recorded by a camera other than the COOLPIX S100 cannot be displayed in auto sort mode.

List by Date Mode

If you tap  **List by date** using the procedure described in “Switching Between Playback Modes” ( 71), the shooting date selection screen is displayed. Tap a date to play back pictures taken on the selected date.

To change the displayed month, tap  or .

- Pictures are displayed in the order that they were taken on the selected date.
- If you tap the **MENU** tab in full-frame or thumbnail playback mode, you can select the playback options ( 73).



Notes on List by Date Mode

- Up to 9,000 of the most recently recorded pictures can be displayed in list by date mode.
- Pictures taken before the date and time have been set are recognized as having been taken on “01/01/2011.”

Playing and Deleting Pictures Taken Continuously (Sequence)

Playing Pictures in a Sequence

Each series of pictures taken using the following settings is saved in a sequence.

- **Auto** mode (📖 37) with **Continuous H** or **Continuous L** selected for the continuous setting (🔑 57).
- **Sports** or **Pet portrait** (when **Continuous** is selected) scene mode (📖 40).

By default, only the first picture of a sequence (key picture) is displayed to represent the pictures in the sequence in full-frame playback mode or thumbnail playback mode (📖 30).

- When only the key picture is displayed for a sequence, the picture cannot be zoomed in on.

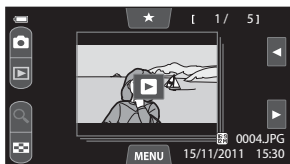

When only the key picture is displayed for a sequence, tap  to display each picture in a sequence individually.

- To display the previous or next picture, drag the current picture to the right or left.
- To return to key picture only display, tap .

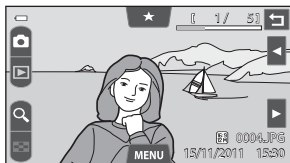

- To display pictures in a sequence as thumbnails, set **Sequence display options** to **Individual pictures** in the setup menu (🔑 94).

Playing and Deleting Pictures Taken Continuously (Sequence)

Note on Sequence

Pictures taken continuously with cameras other than the COOLPIX S100 cannot be displayed as a sequence.

Sequence Display Options

Select **Sequence display options** ( 94) in the setup menu to set all sequences to be displayed using their key pictures or to display them as individual pictures.

Changing Key Picture in Sequence

A sequence's key picture can be changed using **Choose key picture** ( 74) in the playback menu.

Playback Menu Options Available When Using Sequence

When the **MENU** tab is tapped, the following menu operations are available for the pictures in that sequence.

- Favorite pictures¹ ( 10)
- Delete ( 19)
- Slide show ( 62)
- Protect¹ ( 64)
- Print order¹ ( 66)
- Paint² ( 22)
- Retouch² ( 20)
- Voice memo² ( 71)
- Copy¹ ( 73)
- Choose key picture² ( 74)

¹ If the **MENU** tab is tapped when only a key picture displayed, the same settings can be applied to all pictures in that sequence. Tap the **MENU** tab after displaying individual pictures to apply settings to each displayed picture.

² This operation is not available when only a key picture is displayed. Display the pictures in the sequence individually and then tap the **MENU** tab.

Setting the Ratings for a Sequence of Pictures

- If a rating is applied ( 72) to a key picture while it is displayed for a sequence of pictures, the rating is also applied to all the other pictures in the sequence.
- If pictures in a sequence each have their own rating, they are displayed individually when pictures are played back by rating, even when only the key picture is displayed for the sequence.

Deleting Pictures in a Sequence

If **Sequence display options** (🎮 94) in the setup menu is set to **Key picture only**, pictures to be deleted vary as described below. To display the screen for selecting the deletion method, tap the **MENU** tab (📖 12) and tap 🗑️.

- If only key pictures are displayed for sequences when the **MENU** tab is tapped:
 - **Current image:** When a key picture is selected, all pictures in that sequence are deleted.
 - **Erase selected images:** When a key picture is selected in the erase selected images screen, (📖 33), all pictures in the sequence are deleted.
 - **All images:** All pictures are deleted, including the sequence represented by the currently displayed key picture..
- If 📺 is tapped to display each individual picture in the sequence before tapping the **MENU** tab:
Deletion methods change as follows.
 - **Erase current picture:** The picture currently displayed is deleted.
 - **Erase selected images:** When multiple pictures in the sequence are selected in the erase selected images screen (📖 33), the selected pictures are deleted.
 - **Erase entire sequence:** All pictures in the sequence, including the picture currently displayed, are deleted.

Editing Pictures (Still Pictures)

Editing Functions

Use the COOLPIX S100 to edit pictures in-camera and store them as separate files (📷 98). The editing functions described below are available.

Editing function	Description
Paint (📷 22)	Draw on pictures, or add decorations to pictures.
Quick retouch (📷 25)	Easily create retouched copies in which contrast and saturation have been enhanced.
D-Lighting (📷 26)	Create a copy of the current picture with enhanced brightness and contrast, brightening dark portions of the picture.
Stretch (📷 27)	Stretch the current picture horizontally to make the subject appear thinner or wider.
Perspective control (📷 28)	Adjust the perspective of picture taken in landscape orientation. Apply perspective control similar to that available with shift lenses. This function is suited to pictures of buildings or architecture.
Filter effects (📷 29)	Apply a variety of effects using digital filter. The available effects are Color options , Soft , Selective color , Cross screen , Fisheye , and Miniature effect .
Glamour retouch (📷 31)	Make facial skin tone softer and make faces look smaller with larger eyes.
Small picture (📷 33)	Create a small copy of pictures suitable for use as e-mail attachments.
Crop (📷 34)	Crop a portion of the picture. Use to zoom in on a subject or arrange a composition.

See page 📷 70 for the rotate image function for more information.

✓ Notes on Picture Editing

- The editing functions of COOLPIX S100 cannot be used for pictures taken with another make or model of digital camera and pictures taken with **3D photography** (📖 49).
- Pictures taken using **Easy panorama** (📖 47) cannot be edited. However, they can be rotated (📷 70).
- If no face is detected in a picture, a copy cannot be created using the glamour retouch function (📷 31).
- Edited copies created with COOLPIX S100 may not be displayed properly on another make or model of digital camera. It may also be impossible to transfer them to a computer using another make or model of digital camera.
- Editing functions are not available when there is not enough free space in the internal memory or on the memory card.
- Only the paint, small picture, and cropping functions can be used for pictures created in **Draw scene mode** (📖 46).
- To edit an individual picture in a sequence of pictures (📷 17) when only the key picture is displayed, perform one of the procedures described below:
 - Tap 📖 to display a sequence of pictures as individual pictures and select a picture in the sequence.
 - Set **Sequence display options** (📷 94) in the setup menu to **Individual pictures** to display them as individual pictures and select a picture.



Restrictions on Picture Editing

When an edited copy is further modified with another editing function, check the following restrictions.

Editing function used	Editing function to use
Paint	The paint, small picture, or crop function can be used.
Quick retouch D-Lighting Stretch Perspective control Filter effects	The paint, small picture, glamour retouch, or crop function can be used.
Glamour retouch	An editing function other than glamour retouch can be used.
Small picture	Another editing function cannot be used.
Crop	No other editing functions can be used, except for the paint function, which can be applied to cropped copies saved at an image size of  (1920 × 1080) or larger.

- Copies created with editing functions other than the paint function cannot be further edited with the same function used to create them.
- When combining the small picture or crop function and another editing function, use the small picture and crop functions after other editing functions have been applied.
- Retouch effects such as the glamour retouch function's skin softening effect can be applied to pictures taken with the skin softening function ( 52).

Original and Edited Pictures

- Copies created with editing functions are not deleted if the original pictures are deleted. The original pictures are not deleted if copies created with editing functions are deleted.
- Edited copies are stored with the same recording date and time as the original.
- The rating settings ( 72), protect settings ( 64), and print markings ( 66) of the original picture are not applied to edited copies.





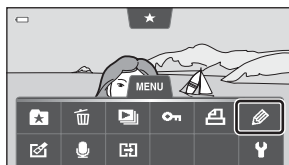

Paint

Draw on pictures or decorate them. Shooting date decoration can also be added. Painted copies are stored as separate files.

- 1 Tap the **MENU** tab in full-frame playback mode and tap .



- 2 Use the , , , and  tools to paint pictures.

- For more information about using each tool, see “Using the Paint Tools” (🔗 23).
- Tap  to display the picture in full-frame playback mode and tap  again to enlarge the picture display by 3x. Tap , , or  to change the portion of the picture visible in the monitor. To return to the original display size, tap .
- Tap  to undo the last operation applied using the pen, eraser, or decoration tool (up to the last five operations can be undone).

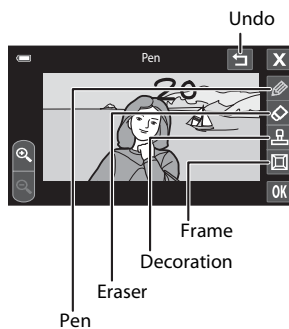

- 3 Tap **OK**.



4 Tap **Yes**.

- A new, painted copy is created.
- Copies created with pictures taken at an **Image mode** (📖 62) setting of **1080** **4608x2592** are saved at the image size of **2M** (1920 x 1080). Copies created with pictures taken at an image mode setting of **3M** **2048x1536** or larger are saved at the image size of **3M** (2048 x 1536). Copies created with pictures taken at an image mode setting of **PC** **1024x768** and **VGA** **640x480** are saved at the image size of **VGA** (640 x 480).
- To exit without saving the copy, tap **No**.
- Copies created with the paint function can be recognized by the 🖋 icon displayed in playback mode.

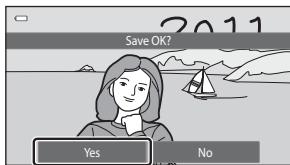

Using the Paint Tools

Write and Draw on Pictures

Tap 🖋 to write or draw on pictures.

You can change the color and weight of the pen using the palette. To hide the palette, tap 🖋 or the picture.

- Tap or drag the pen's color slider to select pen's color.
- Tap the pen's thickness slider to select pen's thickness.

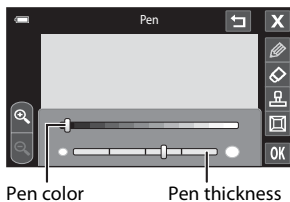

Erase Paint Tool Additions

Tap 🧽 to erase additions to pictures using the paint or decoration tool.

You can change the size of the eraser using the palette. To hide the palette, tap 🧽 or the picture.

- Tap the slider of the eraser's size to select the size of the eraser.

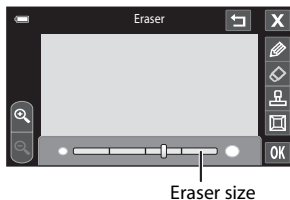

Add Decorations

Tap  to add a decoration.

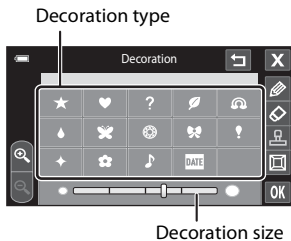

You can change the decoration type or size using the palette. To hide the palette, tap  or the picture.

- Tap a decoration type icon to select the type.
- Tap the decoration size slider to select the decoration size. When **DATE** is selected for the decoration type, tap the slider to choose **DATE** (day, month, year) or **DATE** (day, month, year, time).





Add a Frame

Tap  to add a frame around the picture.

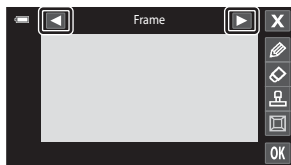
- Tap  or  to select the frame. Each of seven different frames is displayed one by one.



✓ Notes on Shooting Date Decoration

- When the shooting date decoration is added to pictures taken at an **Image mode** setting ( 62) of **VEA 640x480**, the shooting date may be difficult to read. Set the **Image mode** setting of **PC 1024x768** or larger.
- The date added with the shooting date decoration uses the format selected in **Date format** in **Time zone and date** ( 80) under the setup menu.
- The date added with the shooting date decoration is the date on which the picture was taken. The date added with the shooting date decoration cannot be changed.

More Information

See "File and Folder Names" ( 98) for more information.

Quick Retouch: Enhancing Contrast and Saturation

Quick retouch can be used to easily create retouched copies in which contrast and saturation have been enhanced. Copies created with the quick retouch function are stored as separate files.

- 1 Tap the **MENU** tab in full-frame playback mode and tap .

See “Using Menus (MENU Tab)” (📖 11) for more information.

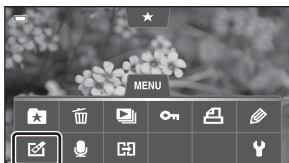

- 2 Tap .

- The screen for selecting the degree of enhancement is displayed.

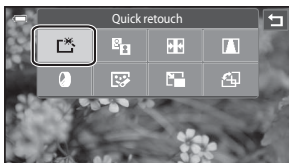

- 3 Choose the degree of enhancement and tap **OK**.



- 4 Tap **Yes**.

- A new, retouched copy is created.
- To exit without saving the copy, tap **No**.
- Copies created with the quick retouch function can be recognized by the  icon displayed in playback mode.



More Information

See “File and Folder Names” (📖 98) for more information.

D-Lighting: Enhancing Brightness and Contrast

D-Lighting can be used to create copies with enhanced brightness and contrast, brightening dark portions of a picture. Enhanced copies are stored as separate files.

- 1 Tap the **MENU** tab in full-frame playback mode and tap .

See “Using Menus (MENU Tab)” (📖 11) for more information.

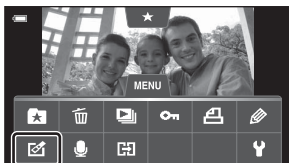

- 2 Tap .

- The original version will be shown on the left and the edited version will be shown on the right.



- 3 Tap **OK**.



- 4 Tap **Yes**.

- A new, edited copy is created.
- To exit without saving the copy, tap **No**.
- Copies created with the D-Lighting function can be recognized by the  icon displayed in playback mode.



More Information

See “File and Folder Names” (📖 98) for more information.

Stretch: Stretching Pictures

Stretch pictures horizontally. Stretched copies are stored as separate files.

- 1 Tap the **MENU** tab in full-frame playback mode and tap .

See “Using Menus (MENU Tab)” (📖 11) for more information.

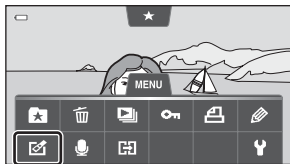

- 2 Tap .



- 3 Tap or drag the slider to adjust stretch effects.

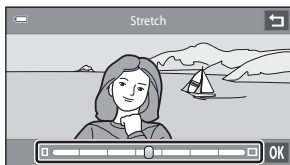

- 4 Tap **OK**.

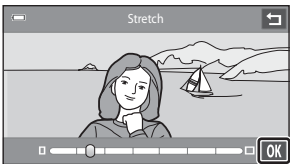

- 5 Tap **Yes**.

- A new, edited copy is created.
- To exit without saving the copy, tap **No**.
- Copies created with the stretch function can be recognized by the  icon displayed in playback mode.

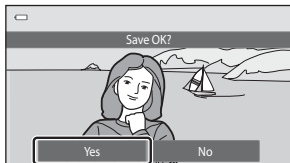

More Information

See “File and Folder Names” (📖 98) for more information.

Perspective Control: Adjust a Sense of Perspective

Adjust the sense of perspective in the picture taken in landscape orientation.

Copies created with the perspective control function are stored as separate files.

- 1 Tap the **MENU** tab in full-frame playback mode and tap .

See “Using Menus (MENU Tab)” (📖 11) for more information.

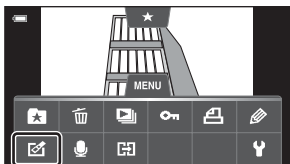

- 2 Tap .

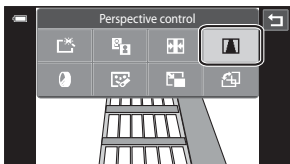

- 3 Tap or drag the slider to adjust perspective control.

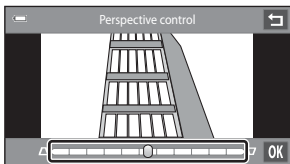

- 4 Tap **OK**.

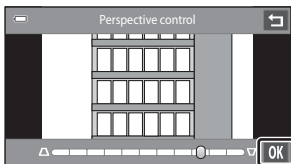

- 5 Tap **Yes**.

- A new, edited copy is created.
- To exit without saving the copy, tap **No**.
- Copies created with the perspective control function can be recognized by the  icon displayed in playback mode.

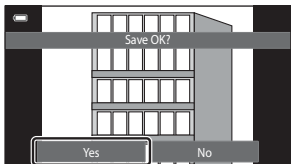









More Information

See “File and Folder Names” (📖 98) for more information.

Filter Effects (Digital Filters)

Filter effects (digital filters) can be used to apply a variety of effects to pictures. The following effects are available. New copies are stored as separate files.

Type	Description
 Color options	Modify color tones using color effects. The available color options are  (vivid color),  (black-and-white),  (sepia), and  (cyanotype).
SOFT Soft	Give the picture a soft look by blurring the area surrounding the point that is tapped.
 Selective color	Keep one specified color in the picture, and change the other colors to black and white.
 Cross screen	Produce star-like rays of light that radiate outward from bright objects such as sunlight reflections or city lights. This effect is suitable for night scenes.
 Fisheye	Make a picture look as if it were taken with a fisheye lens. This effect is well-suited for pictures taken in macro mode.
 Miniature effect	Make a picture look like a miniature scene taken in macro mode. This effect is well-suited for pictures taken from a high vantage point with the main subject at the center of the picture.

1 Tap the **MENU** tab in full-frame playback mode and tap .

- See “Using Menus (MENU Tab)” (📖 11) for more information.

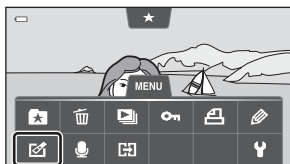

2 Tap .

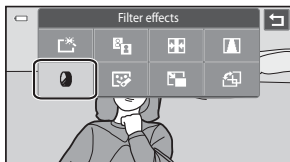

3 Tap the icon of the desired effects.

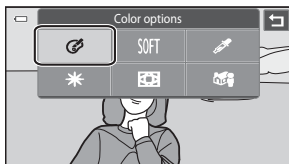

4 Adjust the effects.

- **Color options:** Select the color and tap **OK**.

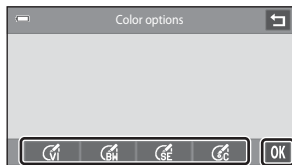

- **Soft:** Tap the area where you want to apply the effect, select the level of the effect, and tap **OK**.
- **Selective color:** Tap the color slider to select the color to keep and tap **OK**.
- **Cross screen, Fisheye, Miniature effect:** Check the results of the effect and tap **OK**.
- A confirmation screen for saving the edited copy is displayed.
- Tap **⏮** to return to step 3 without making any changes.

5 Tap **Yes**.

- A new, edited copy is created.
- To exit without saving the copy, tap **No**.
- Copies created using the filter effects function can be recognized by the **📷** icon displayed in playback mode.



📌 More Information

See "File and Folder Names" (📖 98) for more information.

Glamour Retouch: Softening Skin and Making Up Smaller Faces with Larger Eyes

Glamour retouch can be used to soften the skin tone of faces detected in a picture and make the faces look smaller with larger eyes. New copies are stored as separate files.

1 Tap the **MENU** tab in full-frame playback mode and tap .

- See “Using Menus (MENU Tab)” (📖 11) for more information.

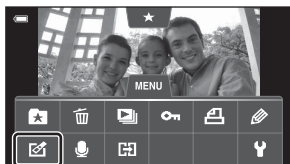

2 Tap .



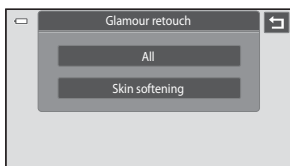

3 Tap **All** or **Skin softening**.

- **All:** Soften facial skin tones, make faces look smaller, and make eyes look larger.
- **Skin softening:** Soften facial skin tones.
- The preview screen is displayed.



4 Preview the result of the effects.

- Skin tones in up to 12 faces, in the order of that closest to the center of the frame, are softened.
- Tap **Before** or **After** to view the picture with or without the effects.
- If more than one face was softened, tap  or  to display a different face.
- To change the effects, tap  to return to step 3.
- Tap **OK** to display the confirmation dialog for saving the new copy.

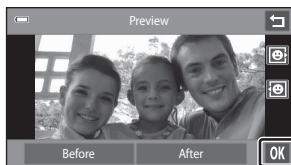

5 Tap **Yes**.

- A new, edited copy is created.
- To exit without saving the copy, tap **No**.
- Copies created using the glamour retouch function can be recognized by the  icon displayed in playback mode.



Notes on Glamour Retouch





- The glamour retouch function cannot be performed when no face is detected in the picture.
- The glamour retouch function may not perform as expected depending on the direction in which the faces are looking or the brightness of the faces in the picture.

More Information

See "File and Folder Names" ( 98) for more information.

Small Picture: Making Smaller Pictures

Create a small copy of the current picture. This feature is useful for creating copies for display on Web pages or e-mail attachments.

- The size of the small copy for pictures taken at an image mode setting of  **4608×2592** is  (1920 × 1080). For pictures taken at other sizes, the options of  **640×480**,  **320×240**, and  **160×120** are available.
- Small copies are saved as separate files with a compression ratio of approximately 1:16.

1 Tap the **MENU** tab in full-frame playback mode and tap .

- See “Using Menus (MENU Tab)” ( 11) for more information.

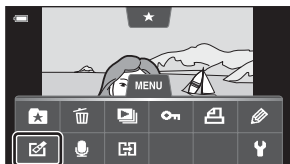

2 Tap .

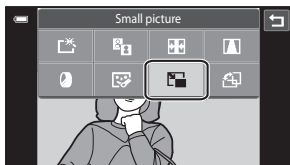

3 Tap the desired small copy size icon and tap **OK**.

- Small picture size cannot be selected for pictures taken at an image mode setting of  **4608×2592**. Tap **OK**.

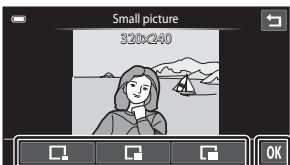

4 Tap **Yes**.

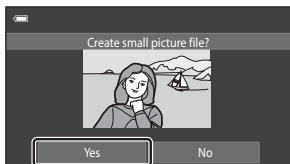

- A new, small copy is created.
- To exit without saving the copy, tap **No**.
- When the copy is played back, it is displayed smaller than the screen.



More Information

See “File and Folder Names” ( 98) for more information.







✂ Crop: Creating a Cropped Copy

Create a copy containing only the portion visible in the monitor when  is displayed with playback zoom ( 31) enabled. Cropped copies are stored as separate files.

1 Enlarge the desired picture in full-frame playback mode (31).



- If portrait-oriented (“tall”) pictures are enlarged and cropped in portrait orientation, the cropped pictures will be in landscape orientation. To create a portrait-oriented (“tall”) cropped copy, rotate the picture into landscape orientation ( 70), before enlarging and cropping.

2 Refine copy composition.

- Tap  or  to adjust the zoom ratio.
- Drag the picture or tap , , , and  so that only the portion to be cropped is visible in the monitor.



3 Tap .

- When  is not displayed, adjust the zoom ratio so that  is displayed.
- Portrait-oriented (“tall”) pictures cannot be cropped if the zoom ratio is too low.



4 Tap **Yes**.

- A cropped copy is created.
- To exit without saving the copy, tap **No**.
- Copies created using the crop function can be recognized by the  icon displayed in playback mode.

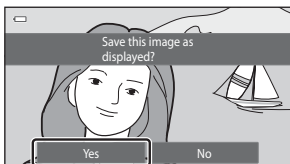



Image Size

- The aspect ratio of the cropped copies is 16:9. As the area to be saved is reduced, the image size (pixels) of the cropped copy is also reduced.
- Cropped copies reduced to 640 × 360 or smaller are displayed smaller than the screen when they are played back.

More Information

See “File and Folder Names” ( 98) for more information.

Connecting the Camera to a TV (Playback on a TV)

Connect the camera to a television to play back pictures or movies on the television. If your TV is equipped with an HDMI port, an HDMI cable (commercially available) can be used to connect the camera to the TV.

- 1 Close the slide cover to turn off the camera.

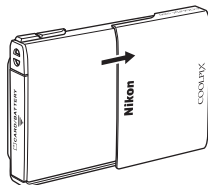

- 2 Connect the camera to the TV.

- Be sure that plugs are properly oriented. Do not attempt to insert plugs at an angle, and do not use force when connecting or disconnecting the plugs.

When using the included audio/video cable

- Connect the yellow plug to the video-in jack and the white and red plugs to the stereo audio-in jacks on the TV.

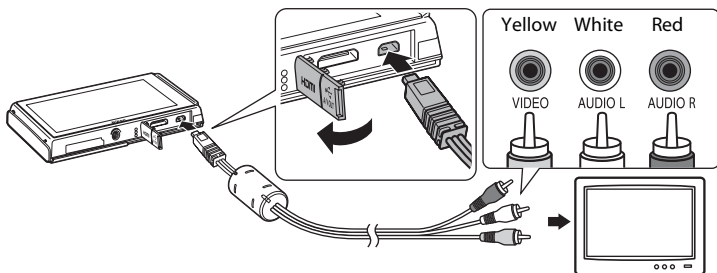

Connecting the Camera to a TV (Playback on a TV)

When using a commercially available HDMI cable

- Connect the plug to the HDMI jack on the TV.

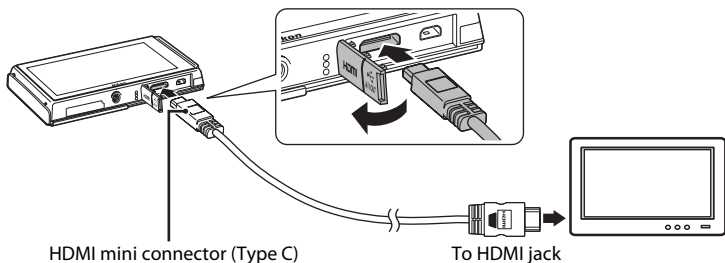

3 Tune the television to the video channel.

- See the documentation provided with your television for details.

4 Open the slide cover to turn on the camera.

- Pictures are displayed on the television and the camera monitor turns off.
- See "Operations with TV Connection" (🔑 37) for more information.

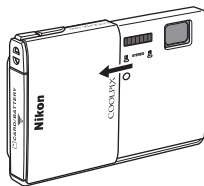

Operations with TV Connection

While pictures are displayed full-frame on the TV, the previous or next picture can be viewed by dragging your finger across the camera monitor.

Thumbnail playback (📖 31) and playback zoom (📖 31) are possible just as with playback mode on the camera.

When the first frame of a movie is displayed, the movie can be played back by holding your finger on the camera monitor and removing it after about one second.

- Tap the camera monitor to turn TV display off and display the picture in the camera monitor. When pictures are displayed in the camera monitor, tap the icons to operate the camera (in playback mode only).
- Pictures will be automatically displayed on the TV in the following situations.
 - No operations are performed for a few seconds in playback mode.
 - A slide show is played back.
 - A movie is played back.

✔ Notes on Connecting the HDMI Cable

- HDMI cable is not provided. Use a commercially available HDMI cable to connect the camera to a high-definition TV. The output terminal on this camera is an HDMI mini connector (type C). When purchasing an HDMI cable, be sure that the device end of the cable is an HDMI mini connector.
- An **Image mode** (📖 62) setting of **3M 2048×1536** or higher and a **Movie options** (🔑 75) setting of **720p HD 720p (1280×720)** or higher are recommended for shooting pictures or movies that will be played back on a TV via HDMI connection.

✔ Connecting the Cable

- Do not connect the HDMI cable and audio/video cable to the camera simultaneously.
- Do not connect the HDMI cable and USB cable to the camera simultaneously.

✔ If the Pictures Are Not Displayed on the Television

Be sure that the camera's video mode setting conforms to the standard used by your television. The video mode setting is specified from the **TV settings** (🔑 91) option in the setup menu (📖 88).

🔑 Using a TV Remote Control (HDMI Device Control)

The remote control of an HDMI-CEC-compatible TV can be used to control playback.

It can be used instead of the camera's touch panel to select pictures, start and pause movie playback, scroll playback of pictures taken using easy panorama, and switch between full-screen playback mode and 6-image thumbnail display.

- Set **HDMI device control** (🔑 91) of **TV settings** to **On** (default setting) in the camera's setup menu and then connect the camera and TV using an HDMI cable.
- Aim the remote control at the TV when operating it.
- Refer to the documentation included with the TV for information about the TV's HDMI-CEC compatibility.

Connecting the Camera to a Printer

Users of PictBridge-compatible (🔦 17) printers can connect the camera directly to the printer and print pictures without using a computer.

Follow the procedures below to print pictures.

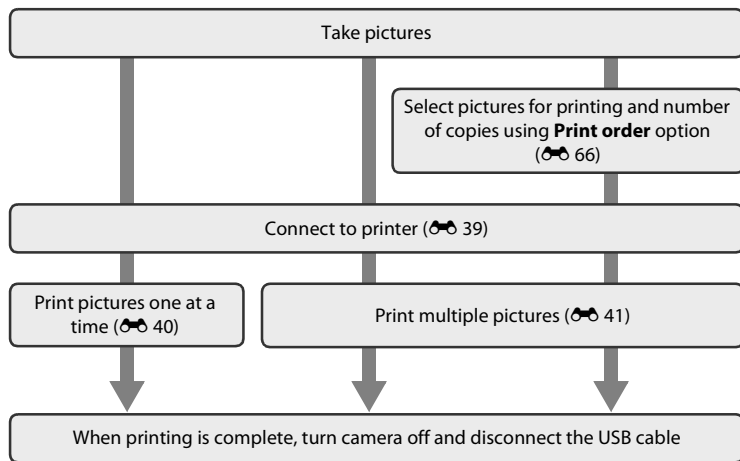

✓ Notes on Power Source

- When connecting the camera to a printer, use a fully charged battery to prevent the camera from turning off unexpectedly.
- If the AC Adapter EH-62G (available separately) is used, COOLPIX S100 can be powered from a home electrical outlet. Do not use any other AC adapters as it will cause the camera to heat up or malfunction.

📎 Printing Pictures

In addition to printing pictures transferred to a computer from your personal printer and printing over a direct camera-to-printer connection, the following options are also available for printing pictures stored on the memory card:

- Insert a memory card into a DPOF-compatible printer's card slot
- Take a memory card to a digital photo lab

To print pictures using either of these methods, use your camera's **Print order** option (🔦 66) to select the pictures, and the desired number of prints each, from those recorded to a memory card.

Connecting the Camera to a Printer

- 1 Close the slide cover to turn off the camera.

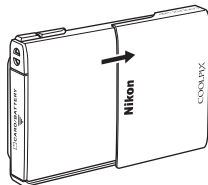

- 2 Turn on the printer.

- Check printer settings.

- 3 Connect the camera to the printer using the included USB cable.

- Be sure that plugs are properly oriented. Do not attempt to insert plugs at an angle, and do not use force when connecting or disconnecting the plugs.

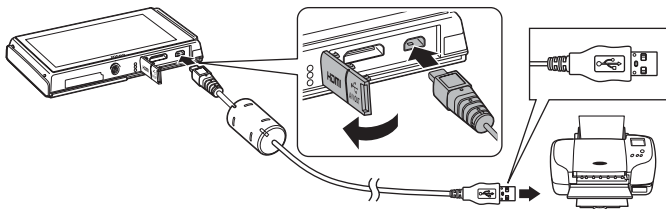

- 4 The camera is automatically turned on.

- When properly connected, the **PictBridge** startup screen (①) will be displayed in the camera monitor, followed by the print selection screen (②).

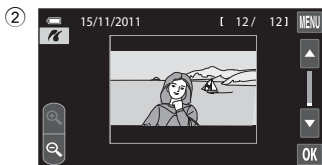
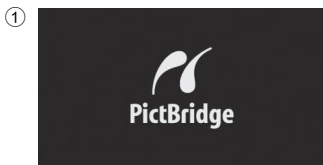

✔ If the PictBridge Startup Screen is not Displayed

Turn the camera off and disconnect the USB cable. Set the **Charge by computer** option (🔌 92) in the camera's setup menu to **Off** and reconnect the cable again.

Printing Pictures One at a Time

After properly connecting the camera to the printer (📷 39), follow the procedures described below to print a picture.

1 Tap **▲** or **▼** to choose the desired picture, and tap **OK**.

- Tap **🔍** to display 12 thumbnails, and **🔍** to switch back to full-frame playback.

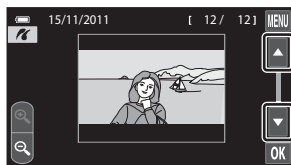

2 Tap **Copies**.

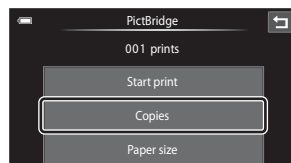

3 Tap the desired number of copies (up to nine).



4 Tap **Paper size**.

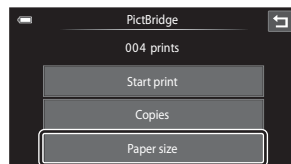

5 Tap the desired paper size.

- Tap **▲** or **▼** to scroll through the display.
- To specify paper size using settings on the printer, tap **Default** in the paper size option.

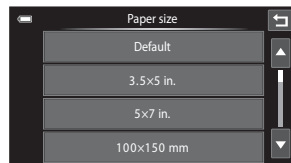

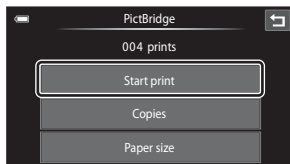
6 Tap **Start print**.**7** Printing begins.

- The monitor display returns to the print selection screen shown in step 1 when printing is complete.
- To cancel printing before all copies have been printed, tap **Cancel**.

Current number of copies/
total number of copies

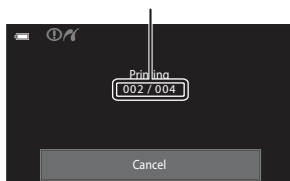
**Printing Multiple Pictures**

After properly connecting the camera to the printer (📷 39), follow the procedures described below to print multiple pictures.

1 When the print selection screen is displayed, tap **MENU**.

- The print menu is displayed.

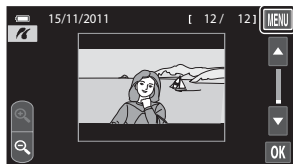
**2** Tap **Paper size**.

- To exit the print menu, tap **OK**.



3 Tap the desired paper size.

- Tap **▲** or **▼** to scroll through the display.
- To specify paper size using settings on the printer, tap **Default** in the paper size option.

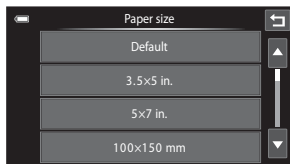
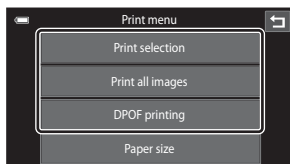
**4** Tap **Print selection**, **Print all images** or **DPOF printing**.**Print selection**

Choose pictures (up to 99) and the number of copies (up to nine) of each.

- Tap the desired pictures and tap **▶** or **▶** at the bottom of the monitor to specify the number of copies to be printed.
- Pictures selected for printing can be recognized by the check mark (✓) and the numeral indicating the number of copies to be printed. Revert the number of copies to [0] to cancel the selection of the picture.
- Tap **◀** to switch back to full-frame playback, and **◀** to display 12 thumbnails.
- Tap **RESET** to remove print marking from all pictures.
- Tap **OK** when setting is complete.
- When the screen shown at right is displayed, tap **Start print** to print.
- To return to the print menu, tap **Cancel**.

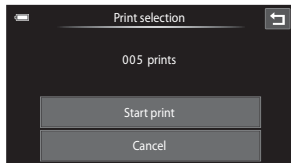
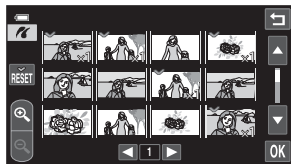

Print all images

One copy each of all pictures stored in the internal memory, or on the memory card, is printed.

- When the screen shown at right is displayed, tap **Start print** to print.
- To return to the print menu, tap **Cancel**.

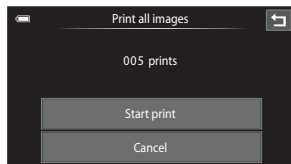

DPOF printing

Print pictures for which a print order was created using the **Print order** option (66).

- When the screen shown at right is displayed, tap **Start print** to print. To return to the print menu, tap .
- To view the current print order, tap **View images**. To print pictures, tap **OK**.

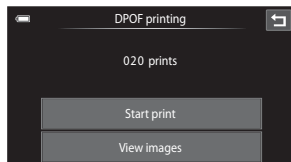

5 Printing begins.

- The monitor display returns to the print menu shown in step 2 when printing is complete.
- To cancel printing before all copies have been printed, tap **Cancel**.

Current number of copies/
total number of copies

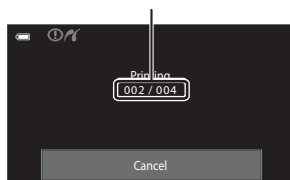

Paper Size

The camera supports the following paper sizes: **Default** (the default paper size for the printer connected to the camera), **3.5x5 in.**, **5x7 in.**, **100x150 mm**, **4x6 in.**, **8x10 in.**, **Letter**, **A3**, and **A4**. Only sizes supported by the printer will be displayed. To specify paper size using printer settings, choose **Default** in the **Paper size** option.

Recording Movies in Slow Motion and Fast Motion (HS Movie)

HS (high speed) movies can be recorded. The portions of the movie recorded using HS movie can be played back in slow motion at 1/8, 1/4, or 1/2 of normal playback speed, or played back in fast motion at a speed two times faster than normal speed. While recording movies, the camera can be switched from normal speed movie recording to slow motion or fast motion movie recording.

- See “HS Movie” (📷 46) for more information.

1 Set the shooting mode to movie and tap the MENU tab.

- See “Recording Movies” (📖 82) for information about setting the shooting mode to movie.

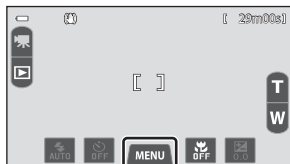

2 Tap and tap an HS movie option.

- See “ Movie Options” (📷 75) for more information.

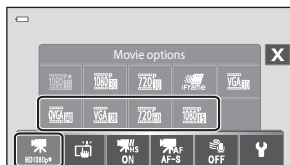

3 Tap to choose whether the camera records normal speed movies or HS movies (slow motion or fast motion movies) when movie recording starts.

- **ON On** (default setting): HS movies are recorded when recording begins.
- **OFF off**: Normal speed movies are recorded when recording begins. Tap the HS movie switch icon (📷 45) to switch to HS movie recording at the point where the camera should record for slow motion or fast motion playback.
- Tap  after changing the settings and return to the shooting screen.

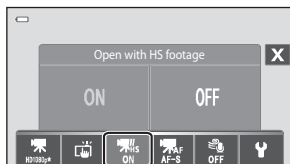

4 Press the shutter-release button to start recording.

- Movie recording begins after the monitor briefly turns off.
- The camera focuses at the center of the frame. Focus areas are not displayed during recording.
- Movie recording starts at HS when the **Open with HS footage** checkbox in the movie menu is checked.
- Movie recording starts at normal speed when the **Open with HS footage** checkbox in the movie menu is not checked. Tap the HS movie switch icon to switch to HS movie recording at the point where the camera should record for slow motion or fast motion playback.
- When an HS movie reaches the maximum length for HS movies (🕒 75), or when the HS movie switch icon is tapped, the camera switches to normal speed movie recording. The camera switches between normal speed movie recording and HS movie recording each time the HS movie switch icon is tapped.
- When recording HS movies, the remaining recording time display changes and displays the remaining movie length for HS movie recording.

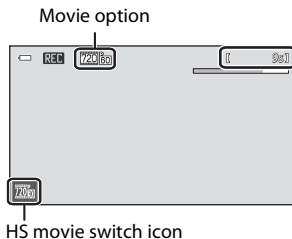

5 Press the shutter-release button to end recording.

- Tapping the monitor can also start or end recording.

Recording Movies in Slow Motion and Fast Motion (HS Movie)

✓ Notes on HS Movie

- Portions recorded for slow motion or fast motion playback are not recorded with sound.
- When recording HS movies, vibration reduction cannot be used. Zoom position, focus, exposure, and white balance are locked when the camera starts recording.

📎 HS Movie

Recorded movies are played back at about 30 frames per second, including portions recorded using HS movie.

When **Movie options** (📷 75) is set to **VGA₂₄₀ HS 240 fps (320×240)**, **VGA₁₂₀ HS 120 fps (640×480)**, or **720₁₅₀ HS 60 fps (1280×720)**, movies that can be played back in slow motion can be recorded.

When set to **1080₁₅ HS 15 fps (1920×1080)**, movies that can be played back in fast motion at a speed two times faster than normal speed can be recorded.

Portions recorded at **VGA₂₄₀ HS 240 fps (320×240)**:

High-speed capturing is possible for up to ten seconds. Portions captured at high speed are played back in slow motion at a speed eight times slower than normal speed.

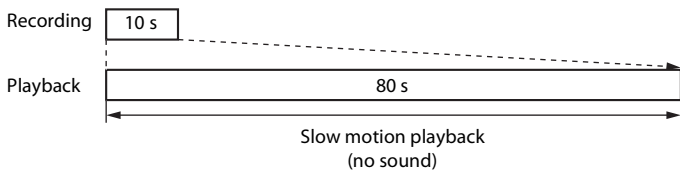

Portions recorded at **1080₁₅ HS 15 fps (1920×1080)**:

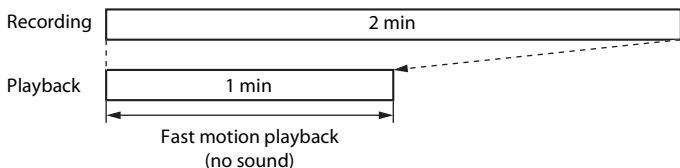

A movie of up to two minutes in length is recorded when shooting for the purpose of high-speed playback. Playback is two times faster.



📎 Returning from HS Movie Setting to Normal Speed Movie Setting

Tap the **MENU** tab and tap a normal speed movie option in the **Movie options** screen (📷 75).

Editing Movies

The desired portions of a recorded movie can be saved as a separate file (except movies recorded using  **iFrame 540 (960x540)** ( 75)).



1 Play back the desired movie and pause playback ( 86).

2 Tap .

- The movie edit screen is displayed.









3 Tap  (choose start point).

- When editing begins, the frame where playback was paused is the start point.
- Tap  or  to move the start point to the beginning of the desired portion of the movie.
- To cancel editing, tap .



4 Tap  (choose end point).

- Tap  or  to move the end point on the right edge to the end of the desired portion of the movie.
- Tap  (preview) to play back the specified portion of the movie that will be saved. While the preview is playing, tap  to adjust the volume. Tap  or  to advance or rewind the movie. While the preview is playing back, tap  to stop playback.



5 When the settings are finished, tap .

6 Tap **Yes**.

- The edited movie is saved.
- To exit without saving, tap **No**.

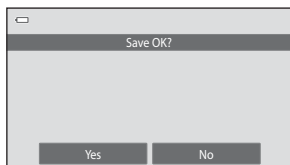



Notes on Movie Editing

- A movie that was created by editing cannot be trimmed again. To trim another area of the movie, select and edit the original movie.
- Movies are trimmed in one-second intervals, therefore the actual trimmed portion of the movie may differ slightly from the selected start and end points. Movies cannot be trimmed so that they are less than 2 seconds long.
- Editing functions are not available when there is not enough free space in the internal memory or on the memory card to save the edited copies.





More Information



See "File and Folder Names" ( 98) for more information.









The Shooting Menu (for (Auto) Mode)

- See “ Changing the Image Size (Image Mode)” ( 62) for information about  **Image mode**.





/ / / **Touch Shooting**

Select  (auto) mode → MENU tab →  /  /  /  Touch shooting



- The touch shooting function can be used in  (auto) mode and other shooting modes (except with **Subject tracking**).
- The **Touch shutter** and **Touch AF/AE** operations differ according to the current shooting mode ( 51,  55).

Option	Description	
 Touch shutter	Pictures can be taken by simply tapping the monitor.	 50
 Subject tracking	Use this option to take pictures of moving subjects. Tap the subject on which the camera will focus. The focus area will automatically move to track the subject.	 52
 /  Touch AF/AE	Tap the monitor to set the focus area. Press the shutter-release button to take the picture with the focus and exposure achieved with the focus area.	 54

Tapping the Monitor to Release the Shutter (Touch Shutter)





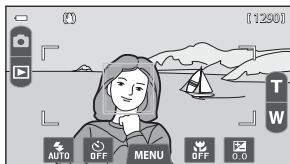
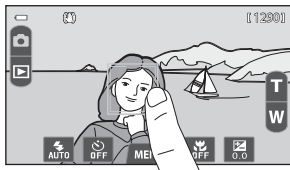

Select  (auto) → MENU tab →   Touch shooting → 

Tap the desired subject to take a picture.

- Do not use force when tapping the monitor as this may cause slight movement of the camera, resulting in blurred pictures.
- When digital zoom is in effect, the camera focuses on the subject in the center of the frame.
- The shutter-release button can also be used when the touch shutter option is selected.
- If  is displayed when the monitor is tapped, the shutter cannot be released. Tap an area within  or a border displayed when the camera detects a face.



Notes on Touch Shutter











- When taking pictures with **Continuous H**, **Continuous L**, or **BSS** in **Continuous** setting ( 57) enabled, or in **Sports** or **Museum** scene mode ( 40), use the shutter-release button to take pictures. Only one picture can be taken at a time using the touch shutter function.
- Prevent shooting with accidental tapping of the monitor by changing the touch shooting setting to **Touch AF/AE** ( 54) (except in some scene modes). At this setting, the shutter is not released when the monitor is tapped. When recording movies, the touch shooting setting is used to enable or disable the touch shutter.
- When shooting a subject that is not suitable for autofocus, the camera may not be able to focus properly on the subject ( 29).
- When a subject displayed in the monitor is tapped with the self-timer ( 56) enabled, the camera locks focus and releases the shutter after ten or two seconds.
- There are functions with which this setting cannot be enabled. See "Features That Cannot Be Applied Simultaneously" ( 64) for more information.

Touch Shooting Setting

The touch shooting setting applied in  (auto) mode is stored in the camera's memory even after the camera is turned off.





 **Shooting Modes That Support Touch Shutter**

The touch shutter can be used in  (auto) mode and other shooting modes. Touch shutter operation differs according to the current shooting mode as follows.

Shooting mode	Touch shutter operation
 (easy auto) mode ( 36), smart portrait mode (when Smile timer is set to Off ;  50)	<ul style="list-style-type: none"> When a face is detected by the camera, it is framed by a border. Tap a detected face to set the focus and exposure on that face. When no face is detected, focus is set for the area tapped.
 (auto) mode ( , Sports, Party/indoor, Beach, Snow, Close-up, Food, Museum, Black and white copy, Backlighting, 3D photography* , and Panorama (panorama assist)* scene modes ( 40)	<p>Tap the intended subject. Focus and exposure are set for the area tapped. When the camera detects more than one face, tap a face framed by a single border to set focus and exposure for that face.</p>
Portrait and Night portrait scene modes ( 40)	<p>Only a border displayed by the face detection function can be selected. When the camera detects more than one face, tap a face framed by a single border to set focus and exposure for that face.</p>
Landscape, Sunset, Dusk/dawn, Night landscape, Fireworks show, and Panorama (easy panorama) scene modes ( 40)	<p>Focus and exposure are set for the same focus area used when pictures are taken by pressing the shutter-release button. See "Selecting a Scene Mode to Take Pictures (Features)" ( 42) for more information.</p>
Smart portrait mode (when Smile timer is set to On ;  50)	<p>Touch shutter cannot be enabled.</p>
Pet portrait scene mode ( 40)	<p>When Pet portrait auto release is set to On: Touch shutter cannot be enabled.</p> <p>When set to Off: Only borders displayed by the pet face detection function can be selected. When the camera detects more than one pet's face, tap a face framed by a single border to move the focus area to that face.</p>





* In **3D photography** and **Panorama** (panorama assist) scene modes, the focus and exposure set for the first shot are used for the following shots.

Subject Tracking (Focusing on a Moving Subject)

Select  (auto) → MENU tab →   Touch shooting → 

 (subject tracking) is enabled only in  (auto) mode.

1 Register a subject.

- Tap the desired tracking subject in the monitor.
 - The subject is registered.
 - When the camera detects any faces, tap a face framed by a border to register it as the subject and begin tracking. If the camera has detected more than one face, the borders around the faces that are not registered disappear.
 - When a subject other than a face is registered, a yellow focus area is displayed on the subject and the camera begins tracking the subject.
 - When the border framing the subject glows red, the camera is unable to focus. Change the composition and try again.
- If the tapped area does not contain a subject that can be registered,   will be displayed in the monitor. Tap a subject within  .
- Tap another subject to change a subject to follow.
- To cancel the registration of the subject, tap  displayed at left in the monitor.
- If the camera cannot track the registered subject anymore, the focus area will disappear and the registration will be canceled. Register the subject again.

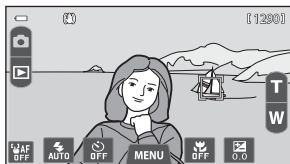
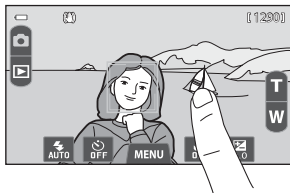





2 Press the shutter-release button to take a picture.

- The camera focuses on the focus area when the shutter-release button is pressed halfway. The focus area will glow green and focus will be locked.
- When the camera is unable to focus, the focus area will blink. Press the shutter-release button halfway again to focus.
- If the shutter-release button is pressed halfway while the focus area is not displayed, the camera focuses on the subject at the center of the frame.
- Press the shutter-release button all the way down to release the shutter.





Notes on Subject Tracking Mode

- Digital zoom is not available.
- The sound of the lens focus motor can be heard when the subject tracking function is working.
- Adjust zoom and apply shooting settings ( 37) before selecting the subject. If zoom or any other setting is adjusted after the subject has been registered, subject registration will be cancelled.
- It may be impossible to register the desired subject, or the camera may be unable to track the registered subject or may begin tracking a different subject, if the subject is moving rapidly, if there is a significant amount of camera shake, or if the camera detects a similar subject. The camera's ability to accurately track the registered subject is also dependent upon the size and brightness of the subject.
- In some rare cases, subjects not suitable for autofocus ( 29) may be out of focus despite the fact that the focus area glows green. In this situation, focus on another subject which is at the same distance from the camera as the intended subject while the shutter-release button is pressed halfway ( 39).
- There are functions with which this setting cannot be enabled. See "Features That Cannot Be Applied Simultaneously" ( 64) for more information.





Touch Shooting Setting

Subject registration with subject tracking will be canceled when the camera is turned off.

Tapping the Monitor to Focus (Touch AF/AE)

Select  (auto) → MENU tab →  Touch shooting → 

1 Tap the subject at which the camera focuses.

-  or a double border will be displayed at the area tapped.
- When digital zoom is in effect, the focus area cannot be selected.
- To cancel the focus area selection, tap  displayed at the left side of the monitor.
- If a position at which focus cannot be acquired is tapped,  will be displayed in the monitor. Tap another position inside .

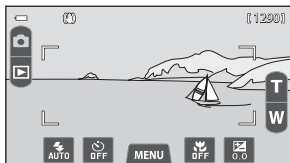
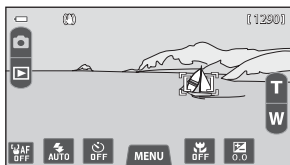

2 Press the shutter-release button to take a picture.

- Press the shutter-release button halfway to acquire focus and exposure and press it all the way down to release the shutter.



Note on Touch AF/AE



When shooting a subject that is not suitable for autofocus, the subject may not be in focus ( 29).

Touch Shooting Setting

The touch shooting setting applied in  (auto) mode is stored in the camera's memory even after the camera is turned off.

 **Shooting Modes That Enable Touch AF/AE Function**

The touch AF/AE can be used in  (auto) mode and other shooting modes. Touch AF/AE operation differs according to the current shooting mode as follows.

Shooting mode	Touch AF/AE operation
 (easy auto) (📖 36), smart portrait mode (when Smile timer is set to Off ; 📖 50)	<ul style="list-style-type: none"> When the camera detects a face, only a face framed by a border can be selected. When the camera detects more than one face, tap a face framed by a single border to set focus and exposure for that face. The single border changes to a double border. When no face is detected, focus is set for the area tapped.
 (auto) mode (📖 37), Sports, Party/indoor, Beach, Snow, Close-up, Food, Museum, Black and white copy, Backlighting, and 3D photography ¹ scene modes (📖 40)	Focus and exposure are set for the area tapped.
Portrait and Night portrait scene modes (📖 40)	Only a border displayed by the face detection function can be selected. When the camera detects more than one face, tap a face framed by a single border to move the focus area to that face.
Landscape, Sunset, Dusk/dawn, Night landscape, Fireworks show, and Panorama scene modes (📖 40), smart portrait mode (when Smile timer is set to On ; 📖 50)	Touch AF/AE cannot be enabled.
Pet portrait scene mode ² (📖 40)	When Pet portrait auto release is set to On : Touch AF/AE is disabled. When set to Off : Only borders displayed by the pet face detection function can be selected. When the camera detects more than one pet's face, tap a face framed by a single border to set the focus and exposure on that face.

¹ The focus and exposure set for the first shot are used for the second shot.



² Set **Pet portrait auto release** to **Off** to enable touch shutter (default setting) or touch AF/AE.

ISO Sensitivity



Select  (auto) mode → MENU tab →  ISO sensitivity

Raising the ISO sensitivity reduces the amount of light needed to make an exposure, allowing pictures to be taken in low light conditions. A higher sensitivity also allows for faster shutter speeds, reducing blur caused by subject movement or camera shake.

- High ISO sensitivity settings are useful when taking pictures in dim lighting, when shooting without a flash, or when using the telephoto setting, but they may also produce “noise” -- randomly spaced, brightly colored pixels -- in the dark areas of images.

Option	Description
 Auto (default setting)	Sensitivity is ISO 125 when there is sufficient lighting; the camera compensates by raising sensitivity to a maximum of ISO 800 when lighting is poor.
 Fixed range auto	Limit the camera’s automatically adjusted ISO sensitivity range to between ISO 125 and ISO 400. By limiting the ISO sensitivity to a maximum of 400, this option moderates the amount of “grain” that appears in pictures.
125, 200, 400, 800, 1600, 3200	Sensitivity is locked at the specified value.









Notes on ISO Sensitivity

- There are functions with which this setting cannot be enabled. See “Features That Cannot Be Applied Simultaneously” ( 64) for more information.
- When the ISO sensitivity setting is set to any option other than **Auto**, motion detection ( 29) is disabled.

Continuous

Select  (auto) mode → MENU tab →  Continuous

Enable continuous shooting or BSS (best shot selector).

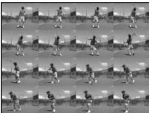
Option	Description
 Single (default setting)	One picture is taken each time the shutter-release button is pressed.
 Continuous H	While the shutter-release button is held down, pictures are taken at a rate of about 8.1 frame per second (fps) when Image mode is set to  4608×2592 . Shooting ends when you remove your finger from the shutter-release button or after 3 pictures are taken.
 Continuous L	While the shutter-release button is held down, up to 18 pictures are taken at a rate of about 1.4 frame per second (fps) when Image mode is set to  4608×2592 . Shooting ends when you remove your finger from the shutter-release button.
 BSS (Best Shot Selector)	The “best shot selector” is recommended when shooting with the flash off or the camera zoomed in, or in other situations in which inadvertent motion can result in blurred pictures. When BSS is on, the camera takes up to ten pictures while the shutter-release button is held down. The sharpest picture in the series is automatically selected and saved.
 Multi-shot 16	<p>Each time the shutter-release button is pressed, camera takes 16 pictures at about 30 frames per second (fps) and arranges them in a single image.</p> <ul style="list-style-type: none"> • Pictures are recorded at an image mode setting of  (image size: 2560 × 1920 pixels). This setting cannot be changed. • Digital zoom is not available. 

Notes on Continuous Shooting

- When **Continuous H**, **Continuous L**, **BSS**, or **Multi-shot 16** is selected, the flash is disabled. Focus, exposure, and white balance are fixed at the values determined with the first picture in each series.
- It may take some time to save the pictures after shooting. The amount of time it takes to finish saving the pictures depends on the number of pictures, image mode, the write speed of the memory card, etc.
- When ISO sensitivity increases, noise may appear in pictures taken.
- The frame rate with continuous shooting may vary depending upon the current image mode setting, the memory card used, or shooting condition.
- When **Multi-shot 16** is selected, banding or variance in brightness or hue may occur in pictures that were taken under lighting that flickers at high speeds, such as fluorescent, mercury-vapor, or sodium-vapor lighting.
- There are functions with which this setting cannot be enabled. See "Features That Cannot Be Applied Simultaneously" ( 64) for more information.



Note on BSS

BSS is effective when taking pictures of still subjects. **BSS** may not produce the desired results if the subject moves or the composition changes while the shutter-release button is held down.

Pictures Taken in Continuous Shooting Mode

Each time pictures are taken using **Continuous H** or **Continuous L**, the pictures are saved as a "sequence" ( 17).







More Information

- See "Subjects Not Suitable for Autofocus" ( 29) for more information.
- See "Playing and Deleting Pictures Taken Continuously (Sequence)" ( 17) for more information.



WB White Balance (Adjusting Hue)

Select  (auto) mode → MENU tab → **WB** White balance

The color of light reflected from an object varies with the color of the light source. The human brain is able to adapt to changes in the color of the light source, with the result that white objects appear white whether seen in the shade, direct sunlight, or under incandescent lighting. Digital cameras can mimic this adjustment by processing images according to the color of the light source. This is known as “white balance.” For natural coloration, choose a white balance setting that matches the light source before shooting. Although the default setting, **Auto**, can be used under most types of lighting, the white balance setting suited to a particular light source can be specified manually to achieve more accurate results.

Option	Description
AUTO Auto (default setting)	White balance automatically adjusted to suit lighting conditions. Best choice in most situations.
PRE Preset manual	Neutral-colored object used as reference to set white balance under unusual lighting conditions. See “Preset Manual” ( 60) for more information.
 Daylight	White balance adjusted for direct sunlight.
 Incandescent	Use under incandescent lighting.
 Fluorescent	Use under fluorescent lighting.
 Cloudy	Use when taking pictures under overcast skies.
 Flash	Use with the flash.

 Note on White Balance Setting

Turn the flash off (  54) at white balance settings other than **Auto** or **Flash**.

Preset Manual

The preset manual option is effective with mixed lighting or to compensate for light sources with a strong color cast (for example, to make pictures taken under a lamp with a red shade look as though they had been taken under white light). Follow the procedure below to measure the white balance value according to the light source when shooting.

1 Place a white or gray reference object under the lighting that will be used during shooting.

2 Tap the **MENU** tab and tap **WB**.

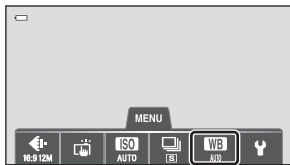

3 Tap **PRE**.

- The camera zooms in to the position for measuring white balance.

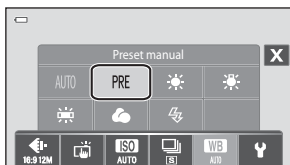

4 Frame the reference object in the measuring window.

- To apply the most recently measured value for preset manual, tap **Cancel**.

Measuring window

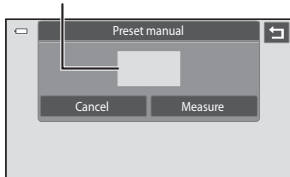

5 Tap **Measure** to measure a value for preset manual.



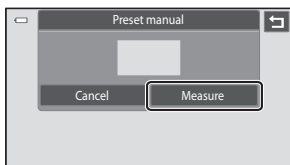

- The shutter is released and the new white balance value is set. No picture is recorded.





Note on Preset Manual

A value for flash lighting cannot be measured with **Preset manual**. When shooting using the flash, set **White balance** to **Auto** or **Flash**.

The Smart Portrait Menu



- See “ Changing the Image Size (Image Mode)” (📖 62) for information about **Image mode**.
- See “ Touch Shooting” (👁️ 49) in “The Shooting Menu (for  (Auto Mode))” for information about  **Touch shooting**.

Skin Softening

Select  (smart portrait) mode → MENU tab →  Skin softening

Enable skin softening.

When the shutter is released, the camera detects one or more human faces (up to three), and processes the image to soften facial skin tones before saving the image.

The degree of skin softening applied can be selected from  **High**,  **Normal** (default setting), and  **Low**.

- The effects of skin softening are not visible when framing pictures for shooting. Check the degree of skin softening performed in playback mode.

Blink Proof

Select  (smart portrait) mode → MENU tab →  Blink proof

When **ON On** is selected, the camera automatically releases the shutter twice each time a picture is taken. Of the two shots, one in which the subject’s eyes are open is saved.

- If the camera saved a picture in which the subject’s eyes may have been closed, the dialog shown on the right is displayed for a few seconds.
- Flash cannot be used when **ON On** is selected.
- The default setting is **OFF Off**.

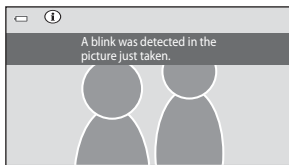

Smile Timer

Select  (smart portrait) mode → MENU tab →  Smile timer

When **ON On** (default setting) is selected, the camera detects human faces and then automatically releases the shutter whenever a smile is detected.

- To enable the touch shutter, select **OFF Off** (👁️ 51).

The Playback Menu

- See “Favorite Pictures Mode” (🔑 10) for information about **Favorite pictures**.
- See “Step 6 Delete Unwanted Pictures” (📖 32) for information about **Delete**.
- See “Editing Pictures (Still Pictures)” (🔑 20) for information about **Paint** and **Retouch**.

📺 Slide Shows

Enter playback mode → MENU tab → 📺 Slide show

Play back pictures, stored in the internal memory or on a memory card, one by one in an automated “slide show.”

1 Tap **Start**.

- To change the effects, tap 📺 (effects) before selecting **Start**, and select from **Classic** or **Zoom**.
- To change the interval between pictures, tap 🕒 (frame interval) and select the desired interval before tapping **Start**.
- To repeat the slide show automatically, tap 🔄 (loop) before tapping **Start**.
- Tap 📷 to play back sample images stored in the camera with an automatic loop function.
- To exit without playing back pictures in a slide show, tap 🏠.

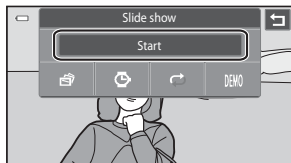

2 The slide show begins.

- Tap the monitor to display the operation panel at the bottom of the screen.

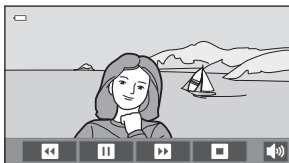



Tap the icons in the operation panel to perform the corresponding operations. The following operations are available.

To	Tap	Description
Adjust volume		Adjust the volume of background music.
Rewind		Tap and hold to rewind slide show.
Advance		Tap and hold to advance slide show.
Pause		Pause playback. • To resume playback, tap displayed at the center of the frame.
End		End slide show.

Notes on Slide Show

- When a movie is played back in a slide show, only its first frame is displayed.
- When **Key picture only** is selected as the method to display sequences (17), only the key picture is displayed.
- Pictures taken using easy panorama (3) are not played back in slide shows.
- Slide show effects cannot be specified when the camera is connected via HDMI and 3D pictures are played back in 3D (9). **Classic** is automatically selected.
- The maximum playback time is up to 30 minutes even if **Loop** is enabled (88).

Protect

Protect selected pictures from accidental deletion. Protected pictures are recognized by the  icon in playback mode ( 8).

Protecting One Picture

- 1 Select the picture to be protected in full-frame playback mode, tap the MENU tab, and tap .

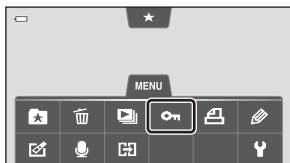

- 2 Tap On.

- The selected picture is protected, and the monitor display returns to the protect setting screen.
- To continue protecting another picture, drag the current picture.
- To exit without protecting pictures, tap .

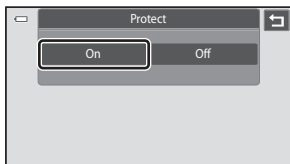

Note on Protecting Pictures

Note that formatting the camera's internal memory or the memory card will permanently delete protected files ( 89).

Protecting Multiple Pictures

Multiple pictures can be protected at a time.

- 1 Switch to thumbnail playback mode (📖 31), tap the **MENU** tab, and then tap **On**.

- The monitor display switches to the picture selection screen for protection.



- 2 Tap the desired pictures to be protected.

- When a picture is selected, a check mark is displayed. To cancel the selection, tap the picture again.
- Tap or to change the number of pictures displayed.



- 3 Tap **OK**.

- The selected pictures are protected.
- To exit without protecting pictures, tap .



Removing Protection from Pictures

- To remove protection from a picture, display a protected picture in full-frame playback mode, follow the procedure in “Protecting One Picture” (🔑 64), and tap **Off** in step 2.
- To remove protection from multiple pictures at a time, uncheck protected pictures in step 2 of “Protecting Multiple Pictures”.

Print Order (Creating a DPOF Print Order)

When printing pictures stored on the memory card using any of the following methods, the **Print order** option in the playback menu is used to create digital “print orders” for printing on DPOF-compatible devices.

- Inserting the memory card into a DPOF-compatible ( 17) printer’s card slot.
- Taking the memory card to a digital photo lab.
- Connecting the camera to a PictBridge-compatible ( 17) printer ( 38). A print order can also be created for pictures stored in the internal memory if the memory card is removed from the camera.

Creating a Print Order for One Picture

- 1 Select the picture to print in full-frame playback mode, tap the **MENU** tab, and tap .

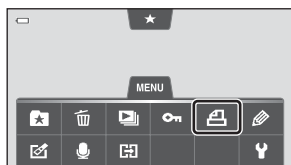

- 2 Tap the desired number of copies (up to nine) and tap **OK**.

- To make a print order for another picture, drag the current picture before tapping **OK**.
- To quit making the print order setting, tap .

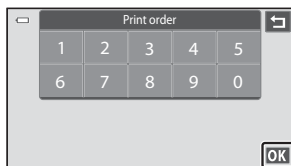

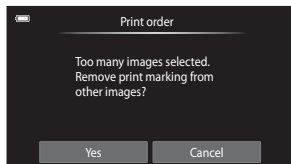

- If the total number of the pictures in a print order, including pictures just added, exceeds 99, the screen shown at right will be displayed.
 - Tap **Yes** to remove pictures previously added from the print order and restrict the print order to pictures just marked.
 - Tap **Cancel** to remove the pictures just added from the print order and restrict the print order to pictures previously marked.

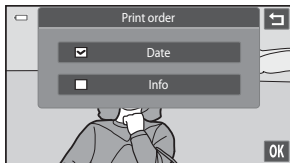

3 Choose whether or not to print shooting date and photo information.

- Tap **Date** to place in the checkbox to imprint the shooting date on the picture.
- Tap **Info** to place in the checkbox to imprint the photo information (shutter speed and aperture value) on the picture.
- Tap **OK** to complete the print order.



Pictures selected for printing are recognized by the  icon displayed with playback.







Creating a Print Order for Multiple Pictures

- 1 Switch to thumbnail playback mode (📖 31), tap the **MENU** tab, and then tap .

- The monitor display switches to the print order setting screen.



- 2 Tap the desired pictures to print (up to 99) and tap  or  at the bottom of the monitor to specify the number of copies (up to nine) for each.

- Pictures selected for printing can be recognized by the check mark (✓) and the numeral indicating the number of copies to be printed. Revert the number of copies to [0] to cancel the selection of the picture.
- Tap  or  to change the number of pictures displayed.
- Tap  to remove print markings from all pictures and cancel the print order.
- Tap **OK** when setting is complete.



- 3 Choose whether or not to print shooting date and photo information.

- Tap **Date** to place in the checkbox to imprint the shooting date on all pictures in the print order.
- Tap **Info** to place in the checkbox to imprint the photo information (shutter speed and aperture value) on all pictures in the print order.
- Tap **OK** to complete the print order.

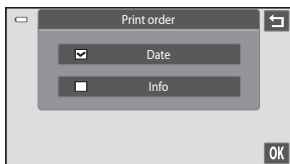

Canceling Print Order

- To remove a print marking from a picture, display a picture selected for printing in full-frame playback mode, follow the procedure in “Creating a Print Order for One Picture” (🔑 66), and tap **0** in step 2.
- To remove print markings from multiple pictures at a time, remove the print markings of the desired pictures in step 2 of “Creating a Print Order for Multiple Pictures” (🔑 68). Tap  to remove print markings from all pictures.

✓ Notes on Printing with Shooting Date and Photo Information

When the **Date** and **Info** settings are enabled in the print order option, shooting date and photo information are printed on pictures when a DPOF-compatible printer (🔑 17) which supports printing of shooting date and photo information is used.

- Photo information cannot be printed when the camera is connected directly to a printer, via the included USB cable, for DPOF printing (🔑 43).
- Note that **Date** and **Info** settings are reset when the print order option is displayed.
- The date printed is that saved when the picture was taken. Changing **Date and time** or **Time zone** in the **Time zone and date** option from the setup menu after a picture is taken has no effect on the date printed on the picture.



Print Date

When date and time of recording are imprinted on pictures using the **Print date** option (🔑 84) in the setup menu, pictures are recorded with shooting date and time imprinted on the picture when they are taken. Pictures with the date imprinted on them can be printed from printers that do not support printing of the date on pictures. Only the date and time imprinted on pictures using the **Print date** option will be printed, even if the date print option is enabled in the **Print order** menu.

Rotate Image

Specify the orientation in which recorded pictures are displayed with playback. Still pictures can be rotated 90 degrees clockwise or 90 degrees counterclockwise. Pictures that were recorded in portrait (“tall”) orientation can be rotated up to 180 degrees in either direction.

1 Tap the **MENU** tab in full-frame playback mode and tap .

See “Using Menus (MENU Tab)” (📖 11) for more information.

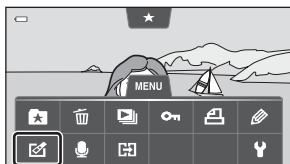

2 Tap .

- The rotate image screen is displayed.

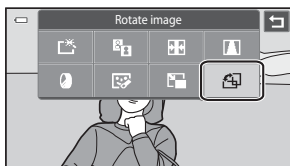

3 Tap or .

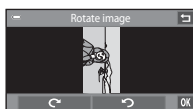

Rotate 90 degrees
clockwise

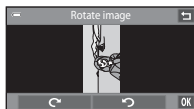

Rotate 90 degrees
counterclockwise

- The picture rotates 90 degrees.
- Tap **OK** to finalize display orientation and save the orientation information with the picture.
- To exit without rotating image, tap .

Voice Memo

Use the camera's built-in microphone to record voice memos for pictures.



Recording Voice Memos

- 1 Tap the **MENU** tab in full-frame playback mode and tap .

- The screen for recording voice memos is displayed.



- 2 Tap  to record a voice memo.



- A voice memo of up to 20 seconds can be recorded.
- Do not touch the built-in microphone during recording.
- To exit without recording voice memos, tap .
- During recording, **REC** blinks in the monitor.
- When  is tapped during recording, recording ends.
- When recording ends, the voice memo playback screen is displayed. Follow the instructions in step 2 of "Playing Voice Memos" ( 72) to play the voice memo.



More Information

See "File and Folder Names" ( 98) for more information.

Playing Voice Memos



Pictures for which voice memos have been recorded are indicated with the  icon in full-frame playback mode ( 8).

1 Tap the **MENU** tab in full-frame playback mode and tap .

- The screen for playing back voice memos is displayed.



2 Tap to play the voice memo.

- Tap  to stop playback.
- Tap  to adjust playback volume.
- To exit without playing voice memos, tap .



Deleting Voice Memos

Tap  in step 2 of "Playing Voice Memos."

Tap **Yes** to delete only the voice memo.



Notes on Voice Memos



- When a picture with a voice memo attached is deleted, both the picture and its voice memo are deleted.
- When a picture with an attached voice memo is protected, neither the picture nor the voice memo can be deleted.
- If a voice memo already exists for the current picture, it must be deleted before a new voice memo can be recorded.
- The COOLPIX S100 is not able to record a voice memo for pictures taken with another make or model of digital camera.

Copy (Copy Between Internal Memory and Memory Card)

Enter playback mode → MENU tab → Copy

Copy pictures between the internal memory and a memory card.

1 Tap a destination option to which pictures are copied in the copy screen.

- : Copy pictures from internal memory to memory card.
- : Copy pictures from memory card to internal memory.

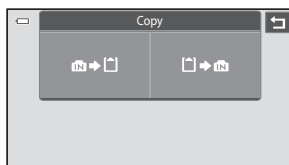

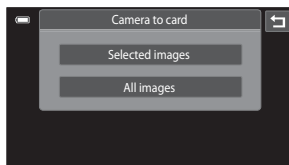

2 Tap a copy option.

- **Selected images:** Copy pictures selected. Proceed to step 3.
- **All images:** Copy all pictures. When a confirmation dialog is displayed, tap **Yes**. Pictures are copied. To cancel copying, tap **No**.



3 Tap the pictures to be copied.

- When a picture is selected, a check mark is displayed. To cancel the selection, tap the picture again. A check mark is removed.
- Tap  to switch to full-frame playback and tap  to switch back to 12-thumbnail display.









4 Tap **OK**.

- When a confirmation dialog is displayed, tap **Yes**. Pictures are copied. To cancel copying, tap **No**.









The Playback Menu

Notes on Copying Pictures

- JPEG-, MOV-, WAV-, and MPO-format files can be copied. Files recorded in any other format cannot be copied.
- If voice memos ( 71) are attached to pictures selected for copying, voice memos are copied with the pictures.
- Operation is not guaranteed with pictures taken with another make of camera or that have been modified on a computer.
- When pictures selected for **Print order** ( 66) are copied, print order marking is not copied with pictures (copies will not be included in the print order). However, rating ( 72) and protect ( 64) settings are copied with pictures.
- Pictures or movies copied from the internal memory or a memory card cannot be displayed in auto sort mode ( 14).
- When a picture that has been added to an album ( 10) is copied, information specifying the album to which the original picture was added is not copied.

Notes on Copying Pictures Taken in Sequence

- If you select a key picture of a sequence in **Selected images** when only the key picture is displayed for the sequence ( 17), all pictures in the sequence are copied.
- If you tap the **MENU** tab and select **Current sequence** after you tap  and display pictures in a sequence as individual pictures, all picture in the sequence are copied.
- If you tap  and display pictures in a sequence as individual pictures, only    (memory card to internal memory) image copy is available.

“Memory contains no images.” Message



If there are no pictures stored on the memory card when playback mode is applied, the message **Memory contains no images.** will be displayed. Tap the **MENU** tab, tap  to display the copy option screen, and copy the pictures saved in the camera’s internal memory to the memory card.



More Information

See “File and Folder Names” ( 98) for more information.

Choose Key Picture

Enter playback mode → **MENU** tab →  Choose key picture

When **Sequence display options** is set to **Key picture only** in the setup menu, the key picture displayed in full-frame playback mode ( 30) and thumbnail playback mode ( 31) can be set for each sequence of pictures.

- When changing this setting, before tapping the **MENU** tab, select the desired sequence and then tap  to display it as individual pictures ( 17).
- When the key picture selection screen is displayed, tap the desired picture and tap **OK**.

The Movie Menu





Movie Options

Set the shooting mode to **Movie** → **MENU** tab → **Movie options**

Select the desired movie option to record. Larger image sizes and faster movie bitrates mean greater image quality and larger movie file sizes.





- The movie bitrate is the volume of movie data recorded per second. Variable bitrate (VBR) encoding is used to automatically adjust the bitrate depending on the subject being recorded. When recording movies of subject with large amounts of motion, the file size increases.
- See page 84 for the information on maximum movie length.
- When recording normal speed movies, select one of the normal speed movie options (75), and when recording HS movies, select one of the HS movie options (76).

Normal Speed Movie Options

Type	Description
 HD 1080p★ (1920×1080) (default setting)	Movies with an aspect ratio of 16:9 are recorded. This option is suited to playback on a widescreen TV. <ul style="list-style-type: none">• Movie bitrate: Approx. 14 Mbps
 HD 1080p (1920×1080)	Movies with an aspect ratio of 16:9 are recorded. This option is suited to playback on a widescreen TV. <ul style="list-style-type: none">• Movie bitrate: Approx. 12 Mbps
 HD 720p (1280×720)	Movies with an aspect ratio of 16:9 are recorded. <ul style="list-style-type: none">• Movie bitrate: Approx. 9 Mbps
 iFrame 540 (960×540)	Movies with an aspect ratio of 16:9 are recorded. A format supported by Apple Inc. <ul style="list-style-type: none">• Movie bitrate: Approx. 24 Mbps Movies cannot be edited (47). When recording movies to the internal memory, recording may stop unexpectedly in some shooting conditions. When recording movies of important events, recording to a memory card (class 6 or higher) is recommended.
 VGA (640×480)	Movies with an aspect ratio of 4:3 are recorded. <ul style="list-style-type: none">• Movie bitrate: Approx. 3 Mbps

- The frame rate is approximately 30 frames per second in any options.

HS Movie Options

Type	Description
 HS 240 fps (320×240)	1/8-speed slow motion movies with a 4:3 aspect ratio are recorded. <ul style="list-style-type: none"> • Max. recording time*: 10 seconds (playback time: 80 seconds) • Movie bitrate: 640 kbps
 HS 120 fps (640×480)	1/4-speed slow motion movies with a 4:3 aspect ratio are recorded. <ul style="list-style-type: none"> • Max. recording time*: 15 seconds (playback time: 1 minute) • Movie bitrate: 3 Mbps
 HS 60 fps (1280×720)	1/2-speed slow motion movies with a 16:9 aspect ratio are recorded. <ul style="list-style-type: none"> • Max. recording time*: 30 seconds (playback time: 1 minute) • Movie bitrate: 9 Mbps
 HS 15 fps (1920×1080)	2× speed fast motion movies with a 16:9 aspect ratio are recorded. <ul style="list-style-type: none"> • Max. recording time*: 2 minutes (playback time: 1 minute) • Movie bitrate: 14 Mbps



* The maximum recording time shown here refers only to the portion of the movie that is recorded in slow motion or fast motion.



More Information

See "File and Folder Names" ( 98) for more information.



Open with HS Footage

Set the shooting mode to  (movie) → MENU tab →  Open with HS footage

Select whether the camera records normal speed movies or HS movies (slow motion or fast motion movies) when movie recording starts.

Option	Description
ON On (default setting)	Record HS movies when movie recording begins.
OFF Off	Record normal speed movies when movie recording begins. Tap the HS movie switch icon ( 45) to switch to HS movie recording at the point where the camera should record for slow motion or fast motion playback.

Autofocus Mode



Set the shooting mode to  (movie) → MENU tab →  Autofocus mode

Select the autofocus method used when recording movies.

Option	Description
AF-S Single AF (default setting)	Focus is locked when movie recording starts. Select this option when the distance between the camera and the subject will remain fairly consistent.
AF-F Full-time AF	Camera focuses continuously. Select this option when the distance between the camera and subject will change significantly during recording. The sound of the camera focusing may be heard in the recorded movie. Use of Single AF is recommended to prevent the sound of the camera focusing from interfering with recording.

- When an HS movie option is selected in **Movie options**, the setting is fixed to **Single AF**.

Wind Noise Reduction

Set the shooting mode to  (movie) → MENU tab →  Wind noise reduction



Select whether wind noise is reduced when recording movies.

Option	Description
ON On	Reduces the sound heard when wind passes over the microphone. Use when recording movies in locations with strong winds. Other sounds may become difficult to hear during playback.
OFF Off (default setting)	Wind noise reduction is not enabled.





- When an HS movie option is selected in **Movie options**, the setting is fixed to **Off**.

The Setup Menu

Welcome Screen

MENU tab →  (setup menu) →  Welcome screen

Choose whether or not a welcome screen is displayed when the camera is turned on.

Option	Description
None (default setting)	The camera enters shooting or playback mode without displaying the welcome screen.
COOLPIX	The camera displays a welcome screen and enters shooting or playback mode.
Select an image	<p>Displays a picture selected for the welcome screen. When the picture selection screen is displayed, select a picture and tap .</p> <ul style="list-style-type: none">• In the picture selection screen, tap  to switch to full-frame playback and tap  to switch back to 12-thumbnail display.• As the selected picture is stored in the camera, it will be displayed when the camera is turned on even if the original picture is deleted.• Pictures cannot be selected if they were taken using Easy panorama or 3D photography, or created at a size of 640 × 360 or smaller using the crop ( 34), or small picture ( 33) function.



Time Zone and Date

MENU tab → 🗨️ (setup menu) → ⌚ Time zone and date

Set the camera clock.

Option	Description
Date and time	<p>Set camera clock to current date and time. Tap the items (day, month, year, hour, and minute) on the displayed screen to set the date and time.</p> <ul style="list-style-type: none"> To select the item: tap the desired item. To edit the highlighted item: tap ▲ or ▼. To apply the setting: tap OK (📄 23).
Date format	<p>Select the order in which the day, month, and year are displayed from Y/M/D (year/month/day), M/D/Y (month/day/year), and D/M/Y (day/month/year).</p>
Time zone	<p>Home time zone (🏠) can be specified and daylight saving time is enabled or disabled. When Travel destination (➔) is selected, local time (🌐 82) is automatically calculated and shooting date and time in the selected region are recorded with pictures. Useful when travelling.</p>

Selecting Travel Destination Time Zone

1 Tap **Time zone**.

- The time zone screen is displayed.

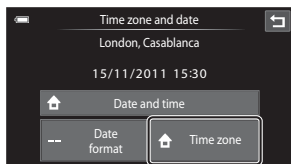

2 Tap ➔ **Travel destination**.

- The date and time displayed in the monitor changes according to the region currently selected.

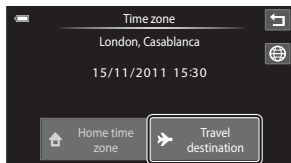



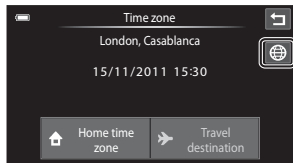

3 Tap .

- The time zone selection screen is displayed.





4 Tap or to choose the travel destination time zone and tap .

- If daylight saving time is in effect, tap  to enable daylight saving time function.  is displayed at the top of the monitor and the camera clock is advanced one hour. Tap  again to disable the daylight saving time function.
- While the travel destination time zone is selected, the  icon will be displayed in the monitor when the camera is in shooting mode.



Home Time Zone

- To switch to the home time zone, tap  **Home time zone** in step 2.
- To change the home time zone, tap  **Home time zone** in step 2, and complete steps 3 and 4.

Daylight Saving Time

When daylight saving time starts or ends, turn the daylight saving time function on or off from the time zone selection screen displayed in step 4.

Imprinting Date on Pictures

Enable the **Print date** option ( 84) in the setup menu after the date and time have been set. When the **Print date** option is enabled, pictures will be recorded with shooting date imprinted on them.

The Setup Menu



Time Zones

The camera supports the time zones listed below.

For time zones not listed below, set the camera clock to local time from the **Date and time** option.

UTC +/-	Location	UTC +/-	Location
-11	Midway, Samoa	+1	Madrid, Paris, Berlin
-10	Hawaii, Tahiti	+2	Athens, Helsinki, Ankara
-9	Alaska, Anchorage	+3	Moscow, Nairobi, Riyadh, Kuwait, Manama
-8	PST (PDT): Los Angeles, Seattle, Vancouver	+4	Abu Dhabi, Dubai
-7	MST (MDT): Denver, Phoenix	+5	Islamabad, Karachi
-6	CST (CDT): Chicago, Houston, Mexico City	+5.5	New Delhi
-5	EST (EDT): New York, Toronto, Lima	+6	Colombo, Dhaka
-4.5	Caracas	+7	Bangkok, Jakarta
-4	Manaus	+8	Beijing, Hong Kong, Singapore
-3	Buenos Aires, Sao Paulo	+9	Tokyo, Seoul
-2	Fernando de Noronha	+10	Sydney, Guam
-1	Azores	+11	New Caledonia
±0	London, Casablanca	+12	Auckland, Fiji

Monitor Settings

MENU tab →  (setup menu) →  Monitor settings



Set the options below.

Option	Description
Photo info	<p>Select whether or not the photo information in the monitor is automatically hidden during shooting and playback. See "Playback Mode (Information Display)" (📖 8) for more information.</p> <ul style="list-style-type: none"> • Show info: Photo information is always displayed. • Auto info (default setting): During playback, photo information is hidden if no operations are performed for a few seconds. The information is displayed again when the next operation is performed. During shooting, some of the operation icons and shooting information are hidden if no operations are performed for a few seconds. They are displayed again when  is tapped.
Image review	<ul style="list-style-type: none"> • On (default setting): Picture is automatically displayed in the monitor immediately after it is taken and the monitor display returns to shooting mode. • Off: Picture is not displayed after it is taken.
Brightness	<p>Choose from five settings for monitor brightness. The default setting is 3.</p>

Auto Monitor Boost



The camera automatically increases monitor brightness outdoors and under extremely bright lighting to make the monitor display easier to see and read (when **Brightness** is set to **4** or less).

Print Date (Imprinting Date and Time)

MENU tab →  (setup menu) →  Print date





The shooting date and time can be imprinted on the pictures with shooting, allowing the information to be printed even from printers that do not support date printing ( 69).



Option	Description
 Date	Date is imprinted on pictures.
 Date and time	Date and time are imprinted on pictures.
Off (default setting)	Date and time are not imprinted on pictures.

At settings other than **Off**, the icon for the current setting is displayed in the monitor ( 6).



Notes on Print Date

- Imprinted dates form a permanent part of image data and cannot be deleted.
- The date cannot be imprinted in the following situations:
 - When using **Sports, Museum, Backlighting** (when **HDR** is set to **On**), **Panorama, Pet portrait** (when **Continuous** is selected), or **3D photography** scene mode.
 - When **On** is selected for **Blink proof** ( 52) in smart portrait mode.
 - When **Continuous H, Continuous L**, or **BSS** is selected for the continuous setting ( 57).
 - When shooting movies.
- Dates imprinted at an **Image mode** setting ( 62) of **VGA 640×480** may be difficult to read. Choose an **Image mode** setting of **PC 1024×768** or larger when using the **Print date** option.
- The date is recorded using the format selected in the setup menu's **Time zone and date** option ( 22,  80).

Print Date and Print Order

If using a DPOF-compatible printer that supports the printing of shooting date and photo information, it is possible to use the **Print order** option ( 66) to print such information even on pictures that were not taken using the **Print date** option.



Vibration Reduction

MENU tab →  (setup menu) →  Vibration reduction

Select the vibration reduction option for shooting.

Vibration reduction reduces blur, caused by slight hand movement known as camera shake, which commonly occurs when shooting with telephoto zoom applied or at slow shutter speeds. The effects of camera shake are reduced when recording movies, in addition to when taking still pictures.

Set **Vibration reduction** to **Off** when using a tripod to stabilize the camera during shooting.



Option	Description
 On (hybrid)	The effects of camera shake are reduced optically only using a lens-shift method. Additional image processing with electronic vibration reduction is applied to further reduce the effects of camera shake with recording of still pictures taken under the following conditions. <ul style="list-style-type: none"> • When flash is disabled. • When a shutter speed slower than 1/60 seconds is used. • When Self-timer is disabled. • When Single is selected for the Continuous setting. • When ISO sensitivity is set to 200 or less.
 On (default setting)	The vibration reduction using the lens-shift method only is enabled.
Off	Vibration reduction is not enabled.

The current vibration reduction setting can be confirmed in the camera monitor with shooting ( 6). When **Off** is selected, no icon is displayed.

Notes on Vibration Reduction

- Vibration reduction may take a few seconds to activate after the power is turned on, or the camera enters shooting mode from playback mode. Wait until the image of the monitor stabilizes before shooting.
- Due to characteristics of the vibration reduction function, images displayed in the camera's monitor immediately after shooting may be displayed blurry.
- Vibration reduction may be unable to completely eliminate the effects of camera shake in some situations.
- Image processing with electronic vibration reduction may not perform as expected with very slight or extreme camera shake, even when **On (hybrid)** is selected.
- Image processing with electronic vibration reduction is not enabled at fast or extremely slow shutter speeds, even when **On (hybrid)** is selected.
- When **On (hybrid)** is selected and electronic vibration reduction is activated, the shutter is automatically released twice when a picture is taken to allow for image processing. Therefore, the time required to record pictures increases. **Shutter sound** ( 87) can be heard only when the shutter is released the first time and a single picture will be recorded.

AF Assist

MENU tab →  (setup menu) →  AF assist

Enable or disable AF-assist illuminator, which assists autofocus operation when the subject is dimly lit.

Option	Description
Auto (default setting)	AF-assist illuminator will be used to assist the focus operation when the subject is poorly lit. The illuminator has a range of about 5 m (16 ft). Note that for some scene modes or focus areas, AF-assist illuminator may not light.
Off	Disable this function. The camera may be unable to focus under poor lighting.

Digital Zoom

MENU tab →  (setup menu) →  Digital zoom



Enable or disable digital zoom.

Option	Description
On (default setting)	When the camera is zoomed in to the maximum optical zoom position, tapping  triggers digital zoom (27).
Off	Digital zoom will not be activated (except when recording movies).

Notes on Digital Zoom

- The camera focuses on the subject at the center of the frame when digital zoom is in effect.
- Digital zoom cannot be used in the following situations:
 - When **Portrait**, **Night portrait**, **Night landscape**, **Backlighting** (when **HDR** is set to **On**), **Panorama** (when **Easy panorama** is selected), **Pet portrait**, or **3D photography** scene mode is selected
 - When smart portrait mode is selected
 - **Subject tracking** is selected for the touch shooting setting
 - When **Multi-shot 16** is selected ([57](#))

Sound Settings

MENU tab →  (setup menu) →  Sound settings



Adjust the following sound settings.

Option	Description
Button sound	Turn button sound On (default setting) or Off . When On (default setting) is selected, beep will sound once when operations are completed successfully, twice when the camera acquires focus on the subject, and three times when an error is detected. Start-up sound will also play when the camera is turned on.
Shutter sound	Choose shutter sound from On (default setting) or Off . No sound is played with shutter release when some features such as continuous shooting or BSS (best shot selector) are enabled, or when recording movies, even if On is selected.

Note on Sound Settings

In **Pet portrait** scene mode, button and shutter sounds are disabled.

Auto Off

MENU tab →  (setup menu) →  Auto off

When the camera is on and a period of time passes without any operations having been performed, the monitor will be turned off and the camera will enter standby mode ( 21) to save power.



Choose the time allowed to elapse before the camera enters standby mode if no operations are performed from **30 s**, **1 min** (default setting), **5 min**, and **30 min**. Press the shutter-release button to cancel standby mode.

Notes on Auto Off

Regardless of the option selected, the monitor will remain on as follows:

- When a setting screen is displayed: three minutes
- During slide show playback: up to 30 minutes

Notes on Auto Off When the Camera is Powered by AC Adapter

- When the AC Adapter EH-62G (available separately;  99) is used, a screen saver function is activated to prevent screen burn if no operations are performed for the time selected for the **Auto off** option (which is fixed to three minutes while a setting screen is displayed). Press the shutter-release button to reactivate the monitor. If no operations are performed for 30 minutes while the screen saver is on, the monitor turns off.
- The pictures used for the screen saver are the same as those displayed when  is tapped with slide show display ( 62), though no background music is played.
- In the following cases, the monitor turns off without the screen saver function being activated:
 - When no operations are performed for 30 minutes with **30 min** selected for **Auto off**, except when a setting screen is displayed.
 - When a slide show lasts for 30 minutes.
- When the camera is connected to a TV or printer, the screen saver function is not activated and the camera does not enter standby mode even when no operations are performed for an extended period of time.

Format Memory/Format Card

MENU tab →  (setup menu) → /  Format memory/Format card

Use this option to format the internal memory or a memory card.

Formatting the internal memory or memory cards permanently deletes all data.

Deleted data cannot be recovered. Be sure to transfer important pictures to a computer before formatting.

Formatting the Internal Memory

To format the internal memory, remove the memory card from the camera.

The **Format memory** option is displayed in the setup menu.

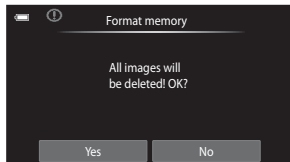

Formatting a Memory Card

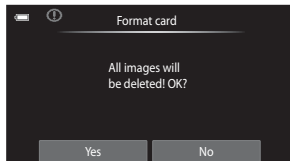

When a memory card is inserted in the camera, the **Format card** option is displayed in the setup menu and the memory card is formatted.



Formatting Internal Memory and Memory Cards

- Formatting the internal memory or memory card restores album icon settings ( 13) to the default setting (displayed as number).
- Do not turn the camera off or open the battery-chamber/memory card slot cover during formatting.
- The first time you insert a memory card that has been used in another device into this camera, be sure to format it with this camera.

Language

MENU tab →  (setup menu) →  Language

Choose one of 29 languages for display of camera menus and messages.

Čeština	Czech
Dansk	Danish
Deutsch	German
English	(default setting)
Español	Spanish
Ελληνικά	Greek
Français	French
Indonesia	Indonesian
Italiano	Italian
Magyar	Hungarian
Nederlands	Dutch
Norsk	Norwegian
Polski	Polish
Português (BR)	Brazilian Portuguese
Português (PT)	Portuguese

Русский	Russian
Română	Romanian
Suomi	Finnish
Svenska	Swedish
Tiếng Việt	Vietnamese
Türkçe	Turkish
Українська	Ukrainian
عربي	Arabic
简体中文	Simplified Chinese
繁體中文	Traditional Chinese
日本語	Japanese
한글	Korean
ภาษาไทย	Thai
हिन्दी	Hindi

TV Settings

MENU tab →  (setup menu) →  TV settings



Adjust settings for connection to a television.

Option	Description
Video mode	Choose from NTSC and PAL .
HDMI	Choose a picture resolution for HDMI output from Auto (default setting), 480p , 720p , or 1080i . When Auto is selected, the option best suited to the high-definition TV to which the camera is connected is automatically selected from 480p , 720p , or 1080i .
HDMI device control	Set whether or not the camera receives signals from an HDMI-CEC compatible television when connected with an HDMI cable. Select On (default setting) to use the television's remote control to perform playback operations. See "Using a TV Remote Control (HDMI Device Control)" ( 37) for more information.
HDMI 3D output	Set the method used to output 3D pictures to HDMI devices. Select On (default setting) to three-dimensionally play back 3D pictures taken with this camera on a TV or monitor that is connected via HDMI.

HDMI and HDMI-CEC

"HDMI" is the abbreviation for High-Definition Multimedia Interface and is one type of multimedia interface. "HDMI-CEC" is the abbreviation for HDMI-Consumer Electronics Control, which enables compatible devices to control each other and allows the user to operate multiple devices with one remote control.

Charge by Computer

MENU tab →  (setup menu) →  Charge by computer

Choose whether or not the battery inserted into the camera is charged when the camera is connected to a computer via the USB cable.

Option	Description
Auto (default setting)	When the camera is connected to a computer that is running, the battery inserted into the camera is automatically charged using power supplied by the computer.
Off	The battery inserted into the camera is not charged when the camera is connected to a computer.

Notes on Connecting the Camera to a Printer

- The battery cannot be charged with connection to a printer, even if the printer complies with the PictBridge standard.
- When **Auto** is selected for **Charge by computer**, it may be impossible to print pictures with direct connection of the camera to some printers. If the **PictBridge** startup screen is not displayed in the monitor after the camera is connected to a printer and turned on, turn the camera off and disconnect the USB cable. Set **Charge by computer** to **Off** and reconnect the camera to the printer.

Notes on Charging with Connection to a Computer

- The battery cannot be charged, nor can data be transferred, when the camera is connected to a computer before the camera's display language and date and time have been set (📖 22). If the camera's clock battery (📖 23) has been exhausted, the date and time must be reset before the battery can be charged or images can be transferred with connection to a computer. In this case, use the Charging AC Adapter EH-69P (📖 16) to charge the battery and then set the camera's date and time.
- If the camera is turned off by opening and closing the slide cover, charging will also stop.
- If a computer enters sleep mode while charging, charging may stop. If the camera remains connected to the computer in sleep mode, the battery runs low because the battery power continues to be consumed until you turn off the camera by opening and closing the slide cover.
- When disconnecting the camera from a computer, turn the camera off by opening and closing the slide cover and then disconnect the USB cable.
- About 3 hours and 45 minutes are required to charge a fully exhausted battery. Charging time increases when images are transferred while the battery is charging.
- When the camera is connected to a computer, an application installed on the computer, such as Nikon Transfer 2, may start. If the camera was connected to the computer for the sole purpose of charging the battery, exit the application.
- The camera turns off automatically if there is no communication with the computer for 30 minutes after the battery has finished charging.
- Depending upon computer specifications, settings, and power supply and allocation, it may be impossible to charge the battery inserted into the camera via computer connection.

Power-on Lamp

The following chart explains power-on lamp status when the camera is connected to a computer.

Power-on lamp	Description
Blinks slowly (orange)	Battery charging.
Glow (green)	Battery not charging. Charging is complete when the power-on lamp stops blinking orange and glows green.
Flickers (orange)	<ul style="list-style-type: none"> The ambient temperature is not suited to charging. Charge the battery indoors with an ambient temperature of 5°C to 35°C (41°F to 95°F). A USB cable is not correctly connected or the battery is faulty. Reconnect the USB cable correctly or replace the battery. Computer is in sleep mode and does not supply power. Reboot the computer. The battery cannot be charged because the computer's specifications or settings do not support power supply to the camera.

Blink Warning

MENU tab →  (setup menu) →  Blink warning

Specify whether or not the camera detects human subjects that blink when shooting with face detection ( 65) in the following modes.

-  (easy auto) mode ( 36) or  (auto) mode ( 37).
- Portrait** ( 42) or **Night portrait** ( 43) is selected for the scene mode.

Option	Description
On	When the camera detects that one or more human subjects may have blinked in a picture taken using face detection, the blink warning screen is displayed in the monitor. The face of the human subject that may have blinked when the shutter was released is framed by a yellow border. Should this occur, check the picture and determine whether or not another picture should be taken. See "Operating the Blink Warning Screen" ( 94) for more information.
Off (default setting)	Blink warning is not enabled.

Note on Blink Warning

Blink detection does not function at continuous settings of **Continuous H**, **Continuous L**, **BSS**, or **Multi-shot 16**.

Operating the Blink Warning Screen

When the blink warning screen shown at right is displayed in the monitor, the operations described below are available.

If no operations are performed within a few seconds, the camera automatically returns to shooting mode.



To	Tap	Description
Enlarge the detected face that blinked		Tap . If the camera detects that more than one human subject blinked, tap or to switch display to another face.
Switch to full-frame playback		Tap .
Delete pictures		Tap .
Switch to shooting mode		Tap . The shutter-release button can also be pressed to return to shooting mode.

Sequence Display Options



MENU tab → (setup menu) → Sequence display options

Choose the method used to display a series of pictures taken continuously (sequence) (17) when viewing them in full-frame playback mode (30) and in thumbnail playback mode (31).

Settings are applied to all sequences, and the setting is saved in the camera's memory even if the camera is turned off.





Option	Description
Individual pictures	Set all pictures in all sequences to be displayed individually. is displayed on the playback screen (8).
Key picture only (default setting)	Set all sequences to be displayed using their key pictures only.

Reset All









MENU tab →  (setup menu) →  Reset all

When **Reset** is selected, the camera's settings will be restored to their default values.





Basic Shooting Functions

Option	Default value
Flash mode ( 54)	Auto
Self-timer ( 56)	Off
Macro mode ( 58)	Off
Exposure compensation ( 59)	0.0



Shooting Menu

Option	Default value
Image mode ( 62)	 4608x2592
Touch shooting ( 50,  52,  54)	Touch shutter
ISO sensitivity ( 56)	Auto
Continuous ( 57)	Single
White balance ( 59)	Auto

Scene Mode

Option	Default value
Scene effect adjustment slider ( 41)	Center
HDR (when Backlighting is selected) ( 46)	Off
Panorama ( 47)	Easy panorama (Normal (180°))
Continuous (when Pet portrait is selected) ( 48)	Continuous
Pet portrait auto release (when Pet portrait is selected) ( 48)	On

Smart Portrait Mode

Option	Default value
Skin softening ( 52)	Normal
Blink proof ( 52)	Off
Smile timer ( 52)	On

Movie Menu

Option	Default value
Movie options (🔍 75)	 HD 1080p★(1920x1080)
Open with HS footage (🔍 77)	On
Autofocus mode (🔍 77)	Single AF
Wind noise reduction (🔍 78)	Off

Setup Menu

Option	Default value
Welcome screen (🔍 79)	None
Photo info (🔍 83)	Auto info
Image review (🔍 83)	On
Brightness (🔍 83)	3
Print date (🔍 84)	Off
Vibration reduction (🔍 85)	On
AF assist (🔍 86)	Auto
Digital zoom (🔍 86)	On
Button sound (🔍 87)	On
Shutter sound (🔍 87)	On
Auto off (🔍 88)	1 min
HDMI (🔍 91)	Auto
HDMI device control (🔍 91)	On
HDMI 3D output (🔍 91)	On
Charge by computer (🔍 92)	Auto
Blink warning (🔍 93)	Off

Others

Option	Default value
Paper size (🔑 40, 🔑 41)	Default
Frame interval for slide show (🔑 62)	2 s
Slide show effects (🔑 62)	Classic

- Selecting **Reset** also clears the current file number (🔑 98) from memory. Numbering will continue from the lowest number available. To reset file numbering to “0001”, delete all pictures stored in the internal memory or on the memory card (📖 32) before selecting **Reset**.
- The following settings will remain unaffected even when **Reset all** is set to **Reset**.
Shooting menu: Preset manual data (🔑 60) acquired for **White balance**
Playback menu: **Choose key picture** (🔑 74)
Setup menu: **Time zone and date** (🔑 80), **Language** (🔑 90), and **Video mode** (🔑 91) under **TV settings**, and **Sequence display options** (🔑 94)

Firmware Version

MENU tab → Y (setup menu) → Ver Firmware version

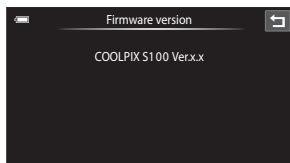

View the current camera firmware version.

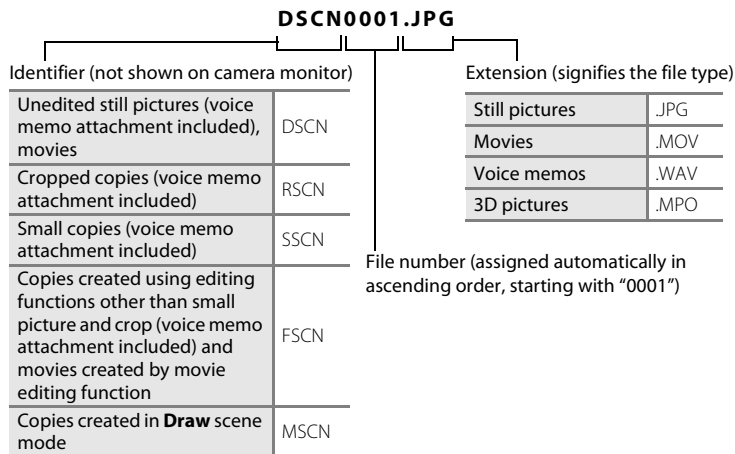

File and Folder Names

Pictures, movies, or voice memos are assigned file names as follows.



- Files are stored in folders named with a folder number followed by an identifier: "P_" plus a three-digit sequential number for pictures taken in **Panorama assist** scene mode (e.g. "101P_001";  6), and "NIKON" for all other pictures (e.g. "100NIKON"). When the number of files within a folder reaches 9999, a new folder will be created. File numbers will be assigned automatically starting with "0001."
- Voice memo file names have the same identifier and file number as the picture to which the voice memo is attached.
- Files copied using **Copy>Selected images** are copied to the current folder, where they are assigned new file numbers in ascending order starting from the largest file number in memory. **Copy>All images** copy all folders from the source medium; file names do not change but new folder numbers are assigned in ascending order, starting from the largest folder number on the destination medium ( 73).
- A single folder can hold up to 200 files; if the current folder already contains 200 files, a new folder, named by adding one to the current folder name, will be created the next time a file is stored. If the current folder is numbered 999 and contains 200 files, or a file is numbered 9999, no further files can be stored until the internal memory or memory card is formatted ( 89), or a new memory card is inserted.

Optional Accessories

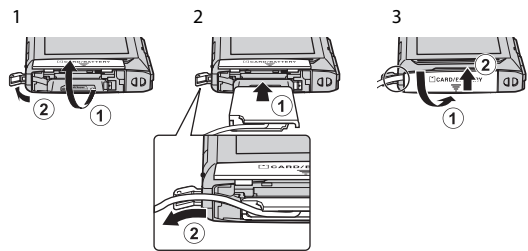











Rechargeable battery	Rechargeable Li-ion Battery EN-EL19 ¹
Charging AC Adapter	Charging AC Adapter EH-69P ^{1, 2}
Battery charger	Battery Charger MH-66
AC adapter	<p>AC Adapter EH-62G (connect as shown)</p>  <p>Be sure that the power connector cord has been properly aligned in power connector and battery chamber grooves before closing the battery-chamber/memory card slot cover. If part of the cord runs out of the grooves, the cover or cord may be damaged when the cover is closed.</p>
USB cable	USB Cable UC-E6 ¹
Audio/video cable	Audio Video Cable EG-CP16 ¹









¹ Included with the camera at the time of purchase (📖 ii).

² When using in other countries, use a plug adapter (available commercially) as necessary. For more information about plug adapters, consult your travel agency.















Error Messages















The following table lists the error messages and other warnings displayed in the monitor, as well as the solutions for dealing with them.

Display	Description	Solution	
 (blinks)	Clock not set.	Set date and time.	 80
 Battery exhausted.	Battery exhausted.	Charge or replace battery.	14, 16
 Battery temperature high	Battery temperature is high.	Turn off camera, and allow battery to cool down before resuming use. When this message appears, the power-on lamp blinks rapidly for five seconds and the monitor turns off.	21
 The camera will turn off to prevent overheating.	Inside of the camera or the memory card has become hot.	Turn off camera, and allow battery to cool down before resuming use.	21
 Check the sliding cover	The slide cover (power switch) is not fully open.	Open or close the slide cover fully.	21
 ● (● blinks red)	Camera cannot focus.	<ul style="list-style-type: none"> • Refocus. • Focus on another subject positioned at the same distance from the camera as the intended subject. 	28, 29 39
 Please wait for the camera to finish recording.	Camera cannot perform other operations until recording is complete.	Wait until message clears from display automatically when recording is complete. Do not open the battery-chamber/memory card slot cover during recording.	–
 Memory card is write protected.	Write-protect switch is in “lock” position.	Slide write-protect switch to “write” position.	–
 This card cannot be used.	Error accessing memory card.	<ul style="list-style-type: none"> • Use approved card. • Check that terminals are clean. • Confirm that memory card is correctly inserted. 	19
 This card cannot be read.			18













Display	Description	Solution	
 Card is not formatted. Format card? Yes No	Memory card has not been formatted for use in COOLPIX S100.	Formatting deletes all data stored on the memory card. Be sure to select No and make copies of any pictures which need to be kept before formatting the memory card. Tap Yes to format.	18
 Out of memory.	Memory card is full.	<ul style="list-style-type: none"> Choose smaller image size. Delete pictures. Insert new memory card. Remove memory card and use internal memory. 	62 32,  19 18 19
 Image cannot be saved.	Error occurred while recording picture.	Format internal memory or memory card.	 89
	Camera has run out of file numbers.	<ul style="list-style-type: none"> Insert new memory card. Format internal memory or memory card. 	18  89
	Picture cannot be used for the welcome screen.	The following types of pictures cannot be used for the welcome screen: <ul style="list-style-type: none"> Pictures taken with Easy panorama or 3D photography, and pictures reduced to 640 × 360 or smaller size with small picture editing or cropping Pictures taken with cameras other than the COOLPIX S100 	 33,  34 –
	Insufficient space to save a copy.	Delete pictures from destination.	32

Error Messages

Display	Description	Solution	
 A blink was detected in the picture just taken.	One or more portrait subjects may have blinked when the picture was taken.	Check the picture in playback mode.	52,  61
 Image cannot be modified.	Cannot edit selected picture.	Select pictures that support editing functions.	 20
 Cannot record movie.	Time out error while recording movie on the memory card.	Choose memory card with faster write speed.	19, 83
 Memory contains no images.	No pictures in the internal memory or memory card.	<ul style="list-style-type: none"> Remove the memory card from the camera to play back pictures stored in the camera's internal memory. To copy pictures from internal memory to memory card, tap the MENU tab and tap . The copy option screen will be displayed and pictures in the internal memory can be copied to memory card. 	19  73
	The picture has not been added to album.	<ul style="list-style-type: none"> Add pictures to album. Choose the album to which picture was added. 	 10  10
	No pictures are contained in the category selected in auto sort mode.	Select the category containing the sorted pictures.	 14
 File contains no image data.	File not created with COOLPIX S100.	Use the computer or other device with which the file was created or edited for playback.	-
 This file cannot be played back.			
 All images are hidden.	No pictures available for a slide show.	-	-

Display	Description	Solution	
 This image cannot be deleted.	Picture is protected.	Disable protection.	 65
 Travel destination is in the current time zone.	Destination in same time zone as home.	–	 80
 Rating maximum reached. No further pictures can be rated.	999 pictures have already been rated.	Cancel the rating setting of them.	72
 No images with this rating found.	There are no pictures with the selected rating.	<ul style="list-style-type: none"> • Apply the rating to pictures. • Select a rating that has been applied to pictures. 	72
 Unable to create panorama.	Could not shoot using easy panorama.	Shooting with easy panorama may not be possible in the following situations. <ul style="list-style-type: none"> • When shooting does not end after a certain amount of time. • When the camera is moved too fast. • When the camera is not moved properly in the panorama direction. 	 3
 Unable to create panorama. Pan the camera in one direction only.			
 Unable to create panorama. Pan the camera more slowly.			
 Failed to take second shot	When taking 3D pictures, the second shot could not be successfully taken after the first shot.	<ul style="list-style-type: none"> • Try shooting again. After taking the first shot, move the camera horizontally and frame the subject so that it is aligned with the guide. • In some shooting conditions, such as when the subject is dark or low in contrast, the second shot may not be taken. 	 8 –
 Failed to save 3D image	Failed to save the 3D pictures.	<ul style="list-style-type: none"> • Try shooting again. • Delete unnecessary pictures. • 3D pictures may not be created depending on the subject or shooting conditions, resulting in failure to save them. 	 8 32 –

Error Messages





Display	Description	Solution	
Lens cover error 	Lens error.	Turn camera off and then on again. If error persists, contact retailer or Nikon-authorized service representative.	20, 21
 Initializing lens. Cannot focus.	The camera cannot focus.	Wait for the camera to recover automatically.	–
 Communications error	Error occurred during communication with printer.	Turn camera off, reconnect USB cable.	 39
System error 	Error has occurred in camera's internal circuitry.	Turn camera off, remove and reinsert battery, and turn camera on. If error persists, contact retailer or Nikon-authorized service representative.	14, 20
 Printer error: check printer status.	Printer error.	Check printer. After solving the problem, tap Resume to resume printing.*	–
 Printer error: check paper	Specified size of paper is not loaded in printer.	Load the specified paper, and tap Resume to resume printing.*	–
 Printer error: paper jam	Paper has jammed in the printer.	Eject the jammed paper, and tap Resume to resume printing.*	–
 Printer error: out of paper	No paper is loaded in printer.	Load the specified paper, and tap Resume to resume printing.*	–
 Printer error: check ink	Ink error.	Check ink, and tap Resume to resume printing.*	–
 Printer error: out of ink	Ink cartridge is empty.	Replace ink cartridge, and tap Resume to resume printing.*	–
 Printer error: file corrupt	An error caused by the image file has occurred.	Tap Cancel to cancel printing.	–

* See the documentation provided with your printer for further guidance and information.



Technical Notes and Index

Maximizing Camera Life and Performance

.....	 2
Memory Cards	 4
Cleaning	 5
Storage	 5

Troubleshooting	 7
------------------------------	--

Specifications	 14
-----------------------------	---

Supported Standards	 17
---------------------------	--

Index	 18
--------------------	---

Maximizing Camera Life and Performance

To ensure continued enjoyment of this Nikon product, observe the precautions described below in addition to the warnings in “For Your Safety” (📖 vi) when using or storing the device.

✔ **Keep Dry**

The device will be damaged if immersed in water or subjected to high humidity.

✔ **Do Not Drop**

The product may malfunction if subjected to strong shock or vibration.

✔ **Handle the Lens and All Moving Parts with Care**

Do not apply force to the lens, monitor, memory card slot or battery-chamber. These parts are easily damaged. Applying force to the lens cover could result in camera malfunction or damage to the lens. Should the monitor break, care should be taken to avoid injury caused by broken glass.

✔ **Do Not Point the Lens at Strong Light Sources for Extended Periods**

Avoid pointing the lens at the sun or other strong light sources for extended periods when using or storing the camera. Intense light may cause deterioration of the image sensor, producing a white blur effect in photographs.

✔ **Keep Away from Strong Magnetic Fields**

Do not use or store this device in the vicinity of equipment that generates strong electromagnetic radiation or magnetic fields. Strong static charge or the magnetic fields produced by equipment such as radio transmitters could interfere with the monitor, damage data saved on the memory card, or affect the product's internal circuitry.

✔ **Avoid Sudden Changes in Temperature**

Sudden changes in temperature, such as when entering or leaving a heated building on a cold day, can cause condensation to form inside the device. To prevent condensation, place the device in a carrying case or a plastic bag before exposing it to sudden changes in temperature.

✔ **Turn the Product Off Before Removing or Disconnecting the Power Source or Memory Card**

Do not remove the battery while the product is on, or while images are being saved or deleted. Forcibly cutting power in these circumstances could result in loss of data or in damage to product memory or internal circuitry.

The Battery

- Check the battery level before using the camera and replace or charge the battery if necessary. Do not continue charging once the battery is fully charged as this will result in reduced battery performance. Whenever possible, carry a fully charged spare battery when taking pictures on important occasions.
- Do not use the battery at ambient temperatures below 0°C (32°F) or above 40°C (104°F).
- Charge the battery indoors with an ambient temperature of 5°C to 35°C (41°F to 95°F) before use.
- When charging the battery inserted into the COOLPIX S100 using the Charging AC Adapter EH-69P or a computer, the charge capacity may decrease at ambient temperatures 45°C to 60°C (113°F to 140°F).
- The battery is not charged at battery temperatures below 0°C (32°F) or above 60°C (140°F).
- Note that the battery may become hot during use; wait for the battery to cool before charging. Failure to observe these precautions could damage the battery, impair its performance, or prevent it from charging normally.
- On cold days, the capacity of batteries tends to decrease. Be sure that the battery is fully charged before heading outside to take pictures in cold weather. Keep spare batteries in a warm place and exchange as necessary. Once warmed, a cold battery may recover some of its charge.
- Dirt on the battery terminals can prevent the camera from functioning. Should the battery terminals become dirty, wipe them off with a clean, dry cloth before use.
- If the battery will not be used for some time, insert it in the camera and run it flat before removing it for storage. The battery should be stored in a cool location with an ambient temperature of 15°C to 25°C (59°F to 77°F). Do not store the battery in hot or extremely cold locations.
- Always remove the battery from the camera or optional battery charger when it is not being used. When inserted, minute amounts of current are drawn from the battery even when not in use. This may result in excessive draining of the battery and complete loss of function. Turning the camera on or off while the battery is exhausted can result in reduced battery life.
- Recharge the battery at least once every six months and completely exhaust it before returning it to storage.
- After removing the battery from the camera or optional battery charger, put the battery in the included battery case and store it in a cool place.
- A marked drop in the time a fully-charged battery retains its charge, when used at room temperature, indicates that the battery needs to be replaced. Purchase a new EN-EL19 battery.
- Replace the battery when it no longer holds a charge. Used batteries are a valuable resource. Please recycle used batteries in accordance with local regulations.

Charging AC Adapter Information

- The Charging AC Adapter EH-69P is for use only with compatible devices. Do not use with another make or model of device.
- The EH-69P is compatible with AC 100–240 V, 50/60 Hz electrical outlets. When using in other countries, use a plug adapter (available commercially) as necessary. For more information about plug adapters, consult your travel agency.
- Do not, under any circumstances, use another make or model of AC adapter other than Charging AC Adapter EH-69P or USB-AC adapter. Failure to observe this precaution could result in overheating or in damage to the camera.

Memory Cards

- Use only Secure Digital memory cards. See “Approved Memory Cards” (📖 19) for more information about memory cards.
- Be sure to follow the precautions described in the documentation included with the memory card.
- Do not put labels or stickers on memory cards.
- We recommend using the camera to format memory cards that have never been used with the camera. Before using a memory card that was previously used in another device, be sure to use this camera to format the memory card.
- Note that **formatting permanently deletes all pictures and other data on the memory card**. Be sure to make copies of any pictures you wish to keep before formatting the memory card.
- If the message **Card is not formatted. Format card?** is displayed after you insert a memory card into the camera, the memory card must be formatted. If there is data that you do not want to delete, tap **No**. Copy the necessary data to a computer, etc. If you want to format the card, tap **Yes**. The confirmation dialog will be displayed. To start formatting, tap **OK**.
- Do not perform the following during formatting, while data is being written to or deleted from the memory card, or during data transfer to a computer. Failure to observe this precaution could result in the loss of data or in damage to the camera or memory card:
 - Open the battery-chamber/memory card slot cover to remove/insert the battery or memory card.
 - Turn off the camera.
 - Disconnect the AC adapter.
- Do not format the memory card using a computer.

Cleaning

Do not use alcohol, thinner, or other volatile chemicals.

Lens	Avoid touching glass parts with your fingers. Remove dust or lint with a blower (typically a small device with a rubber bulb attached to one end that is pumped to produce a stream of air out the other end). To remove fingerprints or other stains that cannot be removed with a blower, wipe the lens with a soft, dry cloth or a cloth for cleaning glasses, using a spiral motion that starts at the center of the lens and working toward the edges. Wiping with too much force or with a hard cloth may damage the lens or cause it to malfunction. If dust or lint still remains, clean the lens using a cloth lightly dampened with commercial lens cleaner.
Monitor	Remove dust or lint with a blower. To remove fingerprints and other stains, wipe the monitor with a soft, dry cloth or a cloth for cleaning glasses, being careful not to apply pressure. Wiping with too much force or with a hard cloth may damage the monitor or cause it to malfunction.
Body	Use a blower to remove dust, dirt, or sand, then wipe gently with a soft, dry cloth. After using the camera at the beach or other sandy or dusty environment, wipe off any sand, dust, or salt with a dry cloth lightly dampened with fresh water and dry thoroughly. Note that foreign matter inside the camera could cause damage not covered by the warranty.

Storage

Turn the camera off when not in use. Be sure that the power-on lamp is off before putting the camera away. Remove the battery if the camera will not be used for an extended period. Do not store the camera with naphtha or camphor moth balls, or in any of the following locations:

- Next to equipment that produces strong electromagnetic fields, such as televisions or radios
- Exposed to temperatures below -10°C (14°F) or above 50°C (122°F)
- Places that are poorly ventilated or subject to humidity of over 60%

To prevent mold or mildew, take the camera out of storage at least once a month. Turn the camera on and release the shutter a few times before putting the camera away again.

For storing the battery, follow the precautions in “The Battery” (🔋 3) in “Maximizing Camera Life and Performance”.









Notes on the Monitor

- The monitor may contain a few pixels that are always lit or that do not light. This does not indicate a malfunction. Images recorded using the product will not be affected.
- Due to the general characteristics of OLED monitors, prolonged or repeated display of the same screen or image may result in screen burn. Screen burn can be recognized by decreased brightness in portions of the monitor or mottled display. In some cases, screen burn may become permanent. However, pictures are in no way affected by screen burn. To prevent screen burn, do not set monitor brightness higher than necessary and do not display the same screen or image for an extended period of time.
- Images in the monitor may be difficult to see under bright lighting.
- The monitor is lit by an LED backlight. Should the monitor begin to dim or flicker, contact your Nikon-authorized service representative.







Troubleshooting

If the camera fails to function as expected, check the list of common problems below before consulting your retailer or Nikon-authorized service representative.

Power Supply, Display, and Settings

Problem	Cause/Solution	
Battery inserted in the camera cannot be charged.	<ul style="list-style-type: none"> • Confirm all connections. • Off is selected for Charge by computer in the setup menu. • When charging by connecting the camera to a computer, battery charging stops when the camera is turned off. • When charging by connecting the camera to a computer, battery charging may stop when the computer is suspended (sleeping). • Depending upon computer specifications, settings, and status, it may be impossible to charge the battery inserted into the camera via computer connection. 	16 90,  92  92  92 –
Camera cannot be turned on.	<ul style="list-style-type: none"> • Battery is exhausted. • The camera cannot be turned on while connected to an electrical outlet via the Charging AC Adapter. 	20 16
Camera turns off without warning	<ul style="list-style-type: none"> • Battery is exhausted. • The camera and battery may not work properly at low temperatures. • If connecting the Charging AC Adapter while the camera is on, the camera turns off. • The camera turns off if the USB cable connecting it to a computer or printer is disconnected. Reconnect the USB cable. • The internal temperature of the camera or the memory card is high. Allow the camera and memory card to cool and turn on the camera again. 	20  3 16 75,  39 21,  100
Monitor is blank	<ul style="list-style-type: none"> • Camera is off. • Standby mode for saving power: press the shutter-release button halfway. • Camera and computer are connected via the USB cable. • Camera and TV are connected via audio/video cable or HDMI cable. 	20 21,  88 75 75,  35









Troubleshooting

Problem	Cause/Solution	
Monitor is hard to read/has darkened	<ul style="list-style-type: none"> • Adjust monitor brightness. • When the internal temperature of the camera is high, the monitor darkens to reduce heat generation. When internal temperature cools, the monitor brightens again. • When the power-on lamp is covered after the camera has automatically increased monitor brightness, the monitor may darken. • Monitor is dirty. Clean monitor. 	88,  83 – –  5
Date and time of recording are not correct	<ul style="list-style-type: none"> • If camera clock has not been set, "Date not set" indicator blinks during shooting and movie recording. Pictures and movies recorded before clock is set are dated "00/00/0000 00:00" or "01/01/2011 00:00" respectively. Set the correct time and date from the Time zone and date option in the setup menu. • Check camera clock regularly against more accurate timepieces and reset as required. 	22, 88 23, 88,  80
No indicators displayed in monitor	Auto info is selected for Photo info in Monitor settings of the setup menu.	88,  83
Print date not available	<ul style="list-style-type: none"> • Time zone and date setting has not been made in the setup menu. • Another function that restricts the Print date option is enabled. 	22, 88,  80 64
Date not imprinted on pictures even when Print date is enabled	<ul style="list-style-type: none"> • Another function that restricts the Print date option is enabled. • Selected shooting mode does not support Print date. • The date cannot be imprinted on movies. 	64  84 –
Screen for setting date and time is displayed when camera is turned on. Camera settings reset	Clock battery is exhausted; all settings were restored to their default values.	23
Monitor turns off, and the power-on lamp blinks green rapidly.	Battery temperature is high. Turn off camera and allow battery to cool down before resuming use.	21
Camera becomes hot.	The camera may become hot when shooting movies for an extended period of time or when the camera is used in a hot area; this is not a malfunction.	–













Electronically Controlled Cameras







In extremely rare instances, unusual characters may appear in the monitor and the camera may stop functioning. In most cases, this phenomenon is caused by a strong external static charge. Turn the camera off, remove and replace the battery, then turn the camera on again. In the event of continued malfunction, contact your retailer or Nikon-authorized service representative. Note that disconnecting the power source as described above may result in the loss of any data not recorded to internal memory or the memory card at the time the problem occurred. Data already recorded will not be affected.

Shooting

Problem	Cause/Solution	
No picture taken.	<ul style="list-style-type: none"> When camera is in playback mode, or setting items or setup menu are displayed, press the shutter-release button. Battery is exhausted. When flash indicator blinks, flash is charging. 	30
		20
		54
Cannot take 3D pictures	In some shooting conditions, such as when the subject is dark or low in contrast, the second shot may not be taken or the 3D picture may not be saved.	–
Cannot switch to shooting mode.	Disconnect HDMI cable, audio/video cable, or USB cable.	75,  35
Camera cannot focus.	<ul style="list-style-type: none"> Subject is too close. Try shooting using macro mode, easy auto mode, or Close-up scene mode. The intended subject is not suitable for autofocus. Set AF assist in the setup menu to Auto. Turn camera off and then on again. 	36, 44, 58
		29
		89,  86
		20
Pictures are blurred.	<ul style="list-style-type: none"> Use flash. Increase ISO sensitivity value. Enable vibration reduction. Use BSS (Best Shot Selector). Use tripod and self-timer. 	54
		38,  56
		89,  85
		38,  57
		56
Bright specks appear in pictures taken with flash.	Flash is reflecting off particles in air. Set the flash mode setting to  (off).	54
Flash does not fire.	<ul style="list-style-type: none"> The flash mode setting is set to  (off). Scene mode with which the flash does not fire is selected. On is selected for Blink proof in smart portrait mode. Movie is selected for shooting mode. Another function that restricts flash is enabled. 	54
		60
		52
		82
		64

Troubleshooting











Problem	Cause/Solution	
Digital zoom cannot be used.	<ul style="list-style-type: none"> • Digital zoom is set to Off in the setup menu. • Digital zoom is not available in the following situations. <ul style="list-style-type: none"> - When Portrait, Night portrait, Night landscape, Backlighting (when HDR is set to On), Panorama (when Easy panorama is selected), Pet portrait, or 3D photography scene mode is selected - Touch shooting is set to Subject tracking - When shooting in smart portrait mode - When Multi-shot 16 is selected for the Continuous setting 	89,  86 42, 43 38,  52 50 38,  57
Image mode not available.	Another function that restricts the Image mode option is enabled.	64
No sound when the shutter is released.	<ul style="list-style-type: none"> • Off is selected for Sound settings>Shutter sound in the setup menu. No sound is heard with some shooting modes and settings, even when On is selected. • The speaker is blocked. Do not cover the speaker. 	89,  87 3, 26
AF-assist illuminator does not light.	Off is selected for the AF assist option in the setup menu. AF-assist illuminator may not light depending on the position of the focus area or the current scene mode, even when Auto is selected.	89,  86
Pictures appear smeared.	Lens is dirty. Clean lens.	 5
Colors are unnatural.	White balance does not match light source.	38,  59
Randomly spaced bright pixels ("noise") appear in image.	Shutter speed too slow or ISO sensitivity is high as the subject is dark. Noise can be reduced by: <ul style="list-style-type: none"> • Using flash • Specifying a lower ISO sensitivity setting 	54 38,  56
Pictures are too dark (underexposed).	<ul style="list-style-type: none"> • The flash mode setting is set to  (off). • Flash window is blocked. • Subject is beyond flash range. • Adjust exposure compensation. • Increase the ISO sensitivity. • Subject is backlit. Select Backlighting scene mode or set the flash mode setting to  (fill flash). 	54 26 54 59 38,  56 46, 54
Pictures are too bright (overexposed).	Adjust exposure compensation.	59







Problem	Cause/Solution	
Unexpected results when flash set to  (auto with red-eye reduction).	When taking pictures with  (auto with red-eye reduction) or fill flash with slow sync and red-eye reduction in Night portrait scene mode, In-Camera Red-Eye Fix may be applied to areas not affected by red-eye. Use any scene mode other than Night portrait , and change the flash mode to any setting other than  (auto with red-eye reduction) and try taking a picture again.	43, 55
Skin tones are not softened.	<ul style="list-style-type: none"> Under some shooting conditions, facial skin tones may not be softened. Select Skin softening for Glamour retouch in the retouch menu for pictures containing four or more faces. 	67 73,  31
Saving images takes time.	It may take more time to save images in the following situations. <ul style="list-style-type: none"> When the noise reduction function is in operation. When flash mode is set to  (auto with red-eye reduction). When shooting in Backlighting scene mode (when HDR is set to On). When the skin softening function is applied while shooting. 	– 55 46 42, 43, 52
A ring-shaped belt or rainbow-colored stripe appears in the monitor or images.	When shooting with backlighting or when a very strong light source (such as sunlight) is in the frame, a ring-shaped belt or rainbow-colored stripe (ghosting) may occur. Change the position of the light source, or frame the picture so that the light source does not enter the frame and try again.	–

Playback

Problem	Cause/Solution	
File cannot be played back.	<ul style="list-style-type: none"> File or folder was overwritten or renamed by computer or other make of camera. The COOLPIX S100 is not able to playback movies recorded with another make or model of digital camera. 	– 86
Cannot zoom in on picture.	<ul style="list-style-type: none"> Pictures taken with cameras other than COOLPIX S100 may not be enlarged. 3D pictures cannot be enlarged when the camera is connected via HDMI and they are played back in 3D. Playback zoom cannot be used with movies, small pictures, or pictures that have been cropped to a size of 640 × 360 or smaller. 	– 49 –

Troubleshooting

Problem	Cause/Solution	
Cannot record or play back voice memo.	<ul style="list-style-type: none"> • Voice memos cannot be attached to movies. • Voice memos cannot be attached to pictures taken with other cameras. Voice memos attached to pictures using another camera cannot be played back on this camera. 	86  72
Cannot edit pictures.	<ul style="list-style-type: none"> • These options cannot be used with movies. • Select pictures that support editing functions. • Pictures taken with another make or model of camera cannot be edited. • Pictures edited with this camera may not be displayed correctly on other cameras and cannot be transferred to computers from other cameras. 	86  20  20  20
Pictures not displayed on television.	<ul style="list-style-type: none"> • Select the correct Video mode and HDMI options from the TV settings item. • Both HDMI cable and audio/video cable or USB cable are connected to the camera. • Memory card contains no pictures. Replace memory card. Remove memory card to play back pictures recorded in the internal memory. 	89,  91 75,  35 18
Album icon restored to default settings, or pictures added to album not displayed in favorite pictures mode.	Data in the memory card may not be played back correctly if overwritten by a computer.	–
The recorded pictures are not displayed in auto sort mode.	<ul style="list-style-type: none"> • The desired picture was sorted to a category other than the category currently displayed. • Pictures recorded by a camera other than the COOLPIX S100 and pictures copied using the Copy option cannot be displayed in auto sort mode. • Pictures recorded in the internal memory or on the memory card may not be played back correctly if overwritten by a computer. • Up to 999 pictures or movies in total can be added to each category. If the desired category already contains 999 pictures or movies in total, new pictures or movies cannot be added. 	70,  14 73,  73 –  15
Nikon Transfer 2 does not start when camera is connected.	<ul style="list-style-type: none"> • Camera is off. • Battery is exhausted. • USB cable is not correctly connected. • Confirm the compatible operating systems. • Camera is not recognized by the computer. • Refer to help information contained in ViewNX 2. 	21 16, 20 78 76 78 79

Problem	Cause/Solution	
The PictBridge startup screen is not displayed when the camera is connected to a printer.	With some PictBridge-compatible printers, the PictBridge startup screen may not be displayed and it may be impossible to print pictures when Auto is selected for the Charge by computer option in the setup menu. Set the Charge by computer option to Off and reconnect the camera to the printer.	90,  39,  92
Pictures to be printed are not displayed.	<ul style="list-style-type: none"> • Memory card contains no pictures. Replace the memory card. • Remove the memory card to print pictures from the internal memory. • Pictures created in Draw scene mode or pictures taken in 3D photography scene mode cannot be printed. 	18 18 40
Cannot select paper size with camera.	Paper size cannot be selected from the camera in the following situations, even when printing from a PictBridge-compatible printer: <ul style="list-style-type: none"> • The printer does not support the paper size specified by the camera. • The printer automatically selects the paper size. 	 40,  41
Edge of printed picture is cropped.	<ul style="list-style-type: none"> • When printing pictures taken at an Image mode setting of  4608x2592 (default setting), the edges of pictures may be cropped, preventing printing of complete pictures. Refer to the documentation included with the printer or consult the digital photo lab for further details to make sure that the printer supports printing at an aspect ratio of 16:9. • Take pictures at the Image mode setting other than  4608x2592. 	– 62
Cannot print panoramas.	When printing panoramas, the entire picture may not be able to be printed depending on the printer's settings. Additionally, printing may not be possible depending on the printer. See the documentation included with the printer or consult a digital photo lab for details.	–

Specifications

Nikon COOLPIX S100 Digital Camera

Type	Compact digital camera
Effective pixels	16.0 million
Image sensor	$\frac{1}{2}$ 3-in. type CMOS; total pixels: approx. 16.79 million
Lens	5 \times optical zoom, NIKKOR lens
Focal length	5.0–25.0mm (angle of view equivalent to that of 28–140 mm lens in 35mm [135] format)
f/-number	f/3.9–4.8
Construction	12 elements in 10 groups (including 2 ED lens elements)
Digital zoom	Up to 4 \times (angle of view equivalent to that of approx. 560 mm lens in 35mm [135] format)
Vibration reduction	Combination of lens shift and electronic VR (still pictures) Lens shift (movies)
Autofocus (AF)	Contrast-detect AF
Focus range (from lens)	<ul style="list-style-type: none">• Approx. 50 cm (1 ft 8 in.) to ∞ (W); approx. 1 m (3 ft 4 in.) to ∞ (T)• Macro mode: 1 cm (0.4 in.) (at a wide-angle zoom position beyond \triangleright) to ∞
Focus-area selection	Face priority, Auto (9-area automatic selection), center, manual (focus area can be selected using the touch panel), subject tracking
Monitor	8.7 cm (3.5-in.), widescreen, OLED (touch panel) with anti-reflection coating, approx. 820k-dot, 5-level brightness adjustment
Frame coverage (shooting mode)	Approx. 98% horizontal and 98% vertical (compared to actual picture)
Frame coverage (playback mode)	Approx. 100% horizontal and 100% vertical (compared to actual picture)
Storage	
Media	<ul style="list-style-type: none">• Internal memory (approx. 71 MB)• SD/SDHC/SDXC memory card
File system	DCF, Exif 2.3, DPOF, MPF compliant
File formats	Still pictures: JPEG 3D pictures: MPO Sound files (Voice Memo): WAV Movies: MOV (video: H.264/MPEG-4 AVC, audio: AAC stereo)
Image size (pixels)	<ul style="list-style-type: none">• 16M (high image quality) [4608 \times 3456 ★]• 16M [4608 \times 3456]• 12M [4000 \times 3000]• 8M [3264 \times 2448]• 5M [2592 \times 1944]• 3M [2048 \times 1536]• PC [1024 \times 768]• VGA [640 \times 480]• 16:9 [4608 \times 2592]

ISO sensitivity (Standard output sensitivity)	<ul style="list-style-type: none"> • ISO 125, 200, 400, 800, 1600, 3200 • Auto (auto gain from ISO 125 to 800) • Fixed range auto (ISO 125 to 400)
Exposure	
Metering	256-segment matrix, center-weighted (digital zoom less than 2x), spot (digital zoom 2x or more)
Exposure control	Programmed auto exposure with motion detection and exposure compensation (–2.0 to +2.0 EV in steps of $\frac{1}{3}$ EV)
Shutter	Mechanical and CMOS electronic shutter
Speed	$\frac{1}{1500}$ –1 s, 4 s (Fireworks show scene mode)
Aperture	Electronically-controlled ND filter (–2.0 AV) insertion
Range	2 steps (f/3.9 and f/7.8 [W])
Self-timer	Can be selected from 10 and 2 second durations
Built-in flash	
Range (approx.) (ISO sensitivity: Auto)	[W]: 0.3 to 3.5 m (1 ft to 11 ft) [T]: 0.5 to 2.2 m (1 ft 8 in. to 7 ft 2 in.)
Flash control	TTL auto flash with monitor preflashes
Interface	Hi-Speed USB
Data Transfer Protocol	MTP, PTP
Video output	Can be selected from NTSC and PAL
HDMI output	Can be selected from Auto , 480p , 720p , and 1080i
I/O terminal	Audio video output/digital I/O (USB) HDMI mini connector (Type C) (HDMI output)
Supported languages	Arabic, Chinese (Simplified and Traditional), Czech, Danish, Dutch, English, Finnish, French, German, Greek, Hindi, Hungarian, Indonesian, Italian, Japanese, Korean, Norwegian, Polish, Portuguese (European and Brazilian), Romanian, Russian, Spanish, Swedish, Thai, Turkish, Ukrainian, Vietnamese
Power sources	One Rechargeable Li-ion Battery EN-EL19 (included) AC Adapter EH-62G (available separately)
Charging time	Approx. 3 hours and 15 minutes (with Charging AC Adapter EH-69P when battery is fully discharged)
Battery life (EN-EL19)	Still pictures*: Approx. 150 shots Movies: Approx. 55 min (HD 1080p★(1920x1080)). (Each movie is limited to a file size of 4 GB and a movie length of 29 minutes, even when there is sufficient free space on the memory card for longer recording.)

Specifications

Tripod socket	1/4 (ISO 1222)
Dimensions (W × H × D)	Approx. 99.0 × 65.2 × 18.1 mm (3.9 × 2.6 × 0.8 in.) (excluding projections)
Weight	Approx. 138 g (4.9 oz) (including battery and SD memory card)
Operating environment	
Temperature	0°C to 40°C (32°F to 104°F)
Humidity	Less than 85% (no condensation)

- Unless otherwise stated, all figures are for a camera with a fully-charged Rechargeable Li-ion Battery EN-EL19 operated at an ambient temperature of 25°C (77°F).

* Based on Camera and Imaging Products Association (CIPA) standards for measuring the life of camera batteries. Measured at 23 (±2) °C (73 (±4) °F); zoom adjusted with each shot, flash fired with every other shot, image mode set to  **4608×2592**. Battery life may vary depending upon shooting interval and length of time menus and images are displayed.

Rechargeable Li-ion Battery EN-EL19

Type	Rechargeable lithium-ion battery
Rated capacity	DC 3.7 V, 700 mAh
Operating temperature	0°C to 40°C (32°F to 104°F)
Dimensions (W × H × D)	Approx. 31.5 × 39.5 × 6 mm (1.3 × 1.6 × 0.3 in.) (excluding projections)
Weight	Approx. 14 g (0.5 oz) (excluding battery case)

Charging AC Adapter EH-69P

Rated input	AC 100–240 V, 50/60 Hz, 0.068–0.042 A
Rated output	DC 5.0 V, 550 mA
Operating temperature	0°C to 40°C (32°F to 104°F)
Dimensions (W × H × D)	Approx. 55 × 22 × 54 mm (2.2 × 0.9 × 2.2 in.) (excluding plug adapter) For Argentina: Approx. 55 × 59 × 63 mm (2.2 × 2.4 × 2.5 in.) For Brazil and Korea: Approx. 55 × 59 × 66.5 mm (2.2 × 2.4 × 2.7 in.)
Weight	Approx. 55 g (2.0 oz) (excluding plug adapter) For Argentina, Brazil, and Korea: Approx. 80 g (2.9 oz)

Specifications

Nikon will not be held liable for any errors this manual may contain. The appearance of this product and its specifications are subject to change without notice.

Supported Standards

- **DCF:** Design Rule for Camera File System is a standard widely used in the digital camera industry to ensure compatibility among different makes of camera.
- **DPOF:** Digital Print Order Format is an industry-wide standard that allows pictures to be printed from print orders stored on memory cards.
- **Exif version 2.3:** This camera supports Exchangeable Image File Format for Digital Still Cameras (Exif) version 2.3 for digital still cameras, a standard that allows information stored with photographs to be used for optimal color reproduction when images are output from Exif-compliant printers.
- **PictBridge:** A standard developed cooperatively by the digital camera and printer industries, allowing photographs to be output directly to a printer without connecting the camera to a computer.

Index

Symbols

- Easy auto mode 24, 36
- Auto mode 37
- Scene mode 40
- Smart portrait mode 50
- Movie 82
- Playback mode 30
- Favorite pictures mode 70,
- Auto sort mode 70,
- List by date 70,
- 3D 3D playback mode 70,
- Setup menu 88
- (telephoto) 27
- (wide-angle) 27
- Playback zoom 31
- Thumbnail playback 31
- MENU** Menu tab 11
- Exit icon 11
- Return icon 12
- AE/AF-L** 6,

Numerics

- 3D photography 49,
- 3D pictures 49, ,
- 3D playback mode 70,
- A**
- AC adapter 17,
- AF-assist illuminator 2, 29,
- Album 70,
 - Adding images to 73,
 - Removing images from 73,
- Aperture 28
- Audio/video cable ii, 75,
- Audio-in/Video-in jack
- Auto flash 55
- Auto mode 37
- Auto off 89,
- Auto sort mode 70,





































- Autofocus 29,
- Autofocus mode
- B**
- Backlighting 46
- Battery ii, 14, 16, 23
- Battery charger 17,
- Battery latch 3
- Battery level 20
- Battery-chamber 3
- Battery-chamber/memory card slot cover 2, 14, 18
- Beach 43
- Best Shot Selector 45,
- Black and white copy 45
- Blink warning 90,
- Brightness 88,
- BSS 38, 45,
- Button sound

C

- Charge by computer 90,
- Charging AC Adapter ii, 16,
- Choose key picture 74, ,
- Close-up 44
- Cloudy
- Connector cover 3
- Continuous 38,
- Copy 73,
- Crop 31,

D

- Date and time 22, 88,
- Date counter
- Date format 22,
- Daylight
- Daylight saving time 23,
- Delete 32, ,
- Digital zoom 27,
- Direct print

- D-Lighting 73, 26
- DPOF 17
 - printing 43
- Drag 4
- Drag and drop 4
- Draw 46, 2
- Dusk/dawn 44
- E**
- Easy panorama 47, 3
- Easy panorama playback 47, 5
- EH-69P 16
- EN-EL19 ii, 14, 16
- Exposure compensation 59
- Extension 98
- Eyelet for camera strap 2
- E**
- Face detection 26, 65
- Favorite pictures mode 70, 10
- File names 98
- Fill flash 55
- Filter effects 73, 29
- Fireworks show 45
- Firmware version 90, 97
- Fixed range auto 56
- Flash 2, 54
- Flash mode 54
- Flash off 55
- Fluorescent 59
- Focus 28
 - area 6, 28, 65
 - Focus lock 39
 - indicator 28
- Folder name 98
- Food 45
- Format 18, 89, 89
- Format memory card 18, 89, 89
- Formatting internal memory 89, 89
- Full-frame playback 30
- Full-time AF 85, 77
- G**
- Glamour retouch 73, 31
- H**
- HDMI 75, 89, 91
- HDMI cable 75, 99, 36
- HDMI device control 89, 91
- Help 40
- HS movie 85, 44
- I**
- Identifier 98
- Image mode 62
- Image review 88, 83
- Image size 62
- Imprinting date and time 84
- Incandescent 59
- Internal memory 19
- Internal memory indicator 6, 8, 20, 82
- ISO sensitivity 38, 56
- J**
- JPG 98
- L**
- Landscape 42
- Language 89, 90
- Lens 2, 14
- List by date mode 70, 16
- M**
- Macro mode 58
- Maximum movie length 84
- Memory capacity 63
- Memory card 18, 19
- Memory card slot 3, 18
- Microphone (stereo) 2
- Monitor 3, 6, 5
- Monitor settings 88, 83
- MOV 98
- Movie editing 86, 47
- Movie menu 85, 75

Index

Movie options 85, 75

Movie playback 86

Multi connector 39

Multi-shot 16 57

Museum  45

N

Night landscape  44

Night portrait  43

Nikon Transfer 2 75, 76

Number of exposures remaining 63

O

Open with HS footage 85, 44, 77

Optional accessories 99

P

Paint 73, 22

Panorama assist 47, 6

Panorama Maker 5 77, 7

Panorama  47

Paper size 40, 41



Party/indoor  43

Perspective control 73, 28

Pet portrait auto release 48

Pet portrait  48

Photo info 83

PictBridge 75, 38, 17

Playback 70, 86, 72

Playback menu 73, 62

Playback mode 10, 30, 70

Playback zoom 31

Portrait  42

Power 20, 22

Power switch (slide cover) 2, 20, 21

Power-on lamp 2, 17, 21, 93

Press halfway 28

Print 75, 40, 41, 66

Print date 88, 84

Print order 73, 66

Printer 75, 38

Protect 73, 64

Q

Quick retouch 73, 25

R

Rechargeable battery 99

Rechargeable Li-ion battery ii, 14, 16, 99

Record orientation 88

Recording movies 82

Recording slow motion movies 85, 44

Red-eye reduction 55

Reset all 90, 95



Rotate image 73, 70

S

Scene mode 40, 42

Self-timer 56

Self-timer lamp 2, 51, 57

Sequence display options 90, 17, 94

Setup menu 88

Shooting 24, 26, 28

Shooting menu 38, 49

Shooting mode 10, 25

Shutter sound 87

Shutter speed 28

Shutter-release button 2, 28

Single 38, 57

Single AF 85, 77

Slide cover (power switch) 2, 20, 21

Slide show 73, 62

Slow Sync 55

Small picture 73, 33

Smart portrait menu 52, 61

Snow  43

Sound settings 89, 87

Speaker 3

Sports  42

Strap 3

Stretch 73, 27

Subject tracking 38, 52

Sunset  44

I



Tap 4

Telephoto zoom 27

Television 35

Thumbnail playback 31

Time difference 23, 82

Time zone 23, 80, 82

Time zone and date 88, 80

Touch AF/AE 38, 54

Touch shooting 50, 52, 54



Touch shutter 38, 50

Tripod socket 3

TV settings 89, 91

U

USB cable ii, 75, 78, 39

USB/audio/video output connector 3, 16,
75, 35, 39

V

Vibration reduction 89, 85

Video mode 89, 91

ViewNX 2 75, 76

Voice memo 73, 71

Volume 86, 72

W

WAV 98

Welcome screen 88, 79

White balance 38, 59

Wide-angle zoom 27

Wind Noise Reduction 85, 78



A series of horizontal dashed lines spanning the width of the page, intended for handwriting practice.

Nikon

No reproduction in any form of this manual, in whole or in part (except for brief quotation in critical articles or reviews), may be made without written authorization from NIKON CORPORATION.



NIKON CORPORATION

© 2011 Nikon Corporation

YP1G02(11)
6MM13111-02