

ASUS[®]

**VX238 series
LCD Monitor**

User Guide

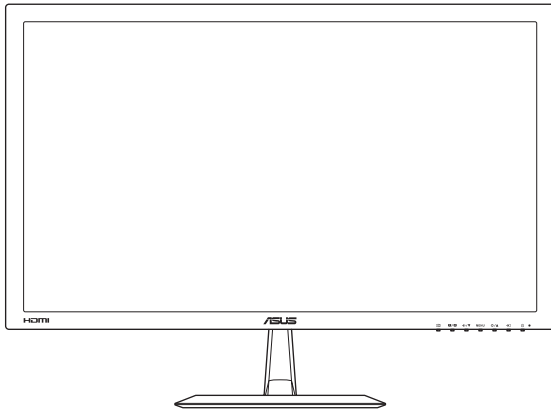

First Edition
July 2012

Copyright © 2012 ASUSTeK COMPUTER INC. All Rights Reserved.

No part of this manual, including the products and software described in it, may be reproduced, transmitted, transcribed, stored in a retrieval system, or translated into any language in any form or by any means, except documentation kept by the purchaser for backup purposes, without the express written permission of ASUSTeK COMPUTER INC. ("ASUS").

Product warranty or service will not be extended if: (1) the product is repaired, modified or altered, unless such repair, modification or alteration is authorized in writing by ASUS; or (2) the serial number of the product is defaced or missing.

ASUS PROVIDES THIS MANUAL "AS IS" WITHOUT WARRANTY OF ANY KIND, EITHER EXPRESS OR IMPLIED, INCLUDING BUT NOT LIMITED TO THE IMPLIED WARRANTIES OR CONDITIONS OF MERCHANTABILITY OR FITNESS FOR A PARTICULAR PURPOSE. IN NO EVENT SHALL ASUS, ITS DIRECTORS, OFFICERS, EMPLOYEES OR AGENTS BE LIABLE FOR ANY INDIRECT, SPECIAL, INCIDENTAL, OR CONSEQUENTIAL DAMAGES (INCLUDING DAMAGES FOR LOSS OF PROFITS, LOSS OF BUSINESS, LOSS OF USE OR DATA, INTERRUPTION OF BUSINESS AND THE LIKE), EVEN IF ASUS HAS BEEN ADVISED OF THE POSSIBILITY OF SUCH DAMAGES ARISING FROM ANY DEFECT OR ERROR IN THIS MANUAL OR PRODUCT.

SPECIFICATIONS AND INFORMATION CONTAINED IN THIS MANUAL ARE FURNISHED FOR INFORMATIONAL USE ONLY, AND ARE SUBJECT TO CHANGE AT ANY TIME WITHOUT NOTICE, AND SHOULD NOT BE CONSTRUED AS A COMMITMENT BY ASUS. ASUS ASSUMES NO RESPONSIBILITY OR LIABILITY FOR ANY ERRORS OR INACCURACIES THAT MAY APPEAR IN THIS MANUAL, INCLUDING THE PRODUCTS AND SOFTWARE DESCRIBED IN IT.

Products and corporate names appearing in this manual may or may not be registered trademarks or copyrights of their respective companies, and are used only for identification or explanation and to the owners' benefit, without intent to infringe.

Table of contents

Notices.....	iv
Safety information	v
Care & Cleaning.....	vi
Takeback Services.....	vii
1.1 Welcome!	1-1
1.2 Package contents.....	1-1
1.3 Monitor introduction.....	1-2
1.3.1 Front view	1-2
1.3.2 Back view.....	1-4
1.3.3 QuickFit Function	1-5
2.1 Assembling the monitor base.....	2-1
2.2 Adjusting the monitor.....	2-1
2.3 Connecting the cables.....	2-2
2.4 Turning on the monitor.....	2-2
3.1 OSD (On-Screen Display) menu	3-1
3.1.1 How to reconfigure.....	3-1
3.1.2 OSD Function Introduction.....	3-1
3.2 Specifications Summary	3-4
3.2.1 VX238H.....	3-4
3.2.2 VX238T.....	3-5
3.2.3 VX238S.....	3-6
3.2.4 VX238N.....	3-7
3.2.5 VX238D.....	3-8
3.3 Troubleshooting (FAQ).....	3-9
3.4 Supported operating modes	3-10

Notices

Federal Communications Commission Statement

This device complies with Part 15 of the FCC Rules. Operation is subject to the following two conditions:

- This device may not cause harmful interference, and
- This device must accept any interference received including interference that may cause undesired operation.

This equipment has been tested and found to comply with the limits for a Class B digital device, pursuant to Part 15 of the FCC Rules. These limits are designed to provide reasonable protection against harmful interference in a residential installation. This equipment generates, uses and can radiate radio frequency energy and, if not installed and used in accordance with manufacturer's instructions, may cause harmful interference to radio communications. However, there is no guarantee that interference will not occur in a particular installation. If this equipment does cause harmful interference to radio or television reception, which can be determined by turning the equipment off and on, the user is encouraged to try to correct the interference by one or more of the following measures:

- Reorient or relocate the receiving antenna.
- Increase the separation between the equipment and receiver.
- Connect the equipment to an outlet on a circuit different from that to which the receiver is connected.
- Consult the dealer or an experienced radio/TV technician for help.

This product implements power management functionality. In case of no signal input after 10 seconds, the product automatically goes to sleep/standby mode.



As an Energy Star® Partner, our company has determined that this product meets the Energy Star® guidelines for energy efficiency.

Canadian Department of Communications Statement

This digital apparatus does not exceed the Class B limits for radio noise emissions from digital apparatus set out in the Radio Interference Regulations of the Canadian Department of Communications.

This class B digital apparatus complies with Canadian ICES-003.

Safety information

- Before setting up the monitor, carefully read all the documentation that came with the package.
 - To prevent fire or shock hazard, never expose the monitor to rain or moisture.
 - Never try to open the monitor cabinet. The dangerous high voltages inside the monitor may result in serious physical injury.
 - If the power supply is broken, do not try to fix it by yourself. Contact a qualified service technician or your retailer.
 - Before using the product, make sure all cables are correctly connected and the power cables are not damaged. If you detect any damage, contact your dealer immediately.
 - Slots and openings on the back or top of the cabinet are provided for ventilation. Do not block these slots. Never place this product near or over a radiator or heat source unless proper ventilation is provided.
 - The monitor should be operated only from the type of power source indicated on the label. If you are not sure of the type of power supply to your home, consult your dealer or local power company.
 - Use the appropriate power plug which complies with your local power standard.
 - Do not overload power strips and extension cords. Overloading can result in fire or electric shock.
 - Avoid dust, humidity, and temperature extremes. Do not place the monitor in any area where it may become wet. Place the monitor on a stable surface.
 - Unplug the unit during a lightning storm or if it will not be used for a long period of time. This will protect the monitor from damage due to power surges.
 - Never push objects or spill liquid of any kind into the slots on the monitor cabinet.
 - To ensure satisfactory operation, use the monitor only with UL listed computers which have appropriate configured receptacles marked between 100-240V AC.
 - If you encounter technical problems with the monitor, contact a qualified service technician or your retailer.
- ‡ This product contains chemicals, including lead, known to the State of California to cause birth defects or other reproductive harm. Wash hands after handling.

Care & Cleaning

- Before you lift or reposition your monitor, it is better to disconnect the cables and power cord. Follow the correct lifting techniques when positioning the monitor. When lifting or carrying the monitor, grasp the edges of the monitor. Do not lift the display by the stand or the cord.
- Cleaning. Turn your monitor off and unplug the power cord. Clean the monitor surface with a lint-free, non-abrasive cloth. Stubborn stains may be removed with a cloth dampened with mild cleaner.
- Avoid using a cleaner containing alcohol or acetone. Use a cleaner intended for use with the LCD. Never spray cleaner directly on the screen, as it may drip inside the monitor and cause an electric shock.

The following symptoms are normal with the monitor:

- The screen may flicker during the initial use due to the nature of the fluorescent light. Turn off the Power Switch and turn it on again to make sure that the flicker disappears.
- You may find slightly uneven brightness on the screen depending on the desktop pattern you use.
- When the same image is displayed for hours, an afterimage of the previous screen may remain after switching the image. The screen will recover slowly or you can turn off the Power Switch for hours.
- When the screen becomes black or flashes, or cannot work anymore, contact your dealer or service center to fix it. Do not repair the screen by yourself!

Conventions used in this guide



WARNING: Information to prevent injury to yourself when trying to complete a task.



CAUTION: Information to prevent damage to the components when trying to complete a task.



IMPORTANT: Information that you **MUST** follow to complete a task.



NOTE: Tips and additional information to aid in completing a task.

Where to find more information

Refer to the following sources for additional information and for product and software updates.

1. ASUS websites

The ASUS websites worldwide provide updated information on ASUS hardware and software products. Refer to <http://www.asus.com>

2. Optional documentation

Your product package may include optional documentation that may have been added by your dealer. These documents are not part of the standard package.

Takeback Services

ASUS recycling and takeback programs come from our commitment to the highest standards for protecting our environment. We believe in providing solutions for our customers to be able to responsibly recycle our products, batteries and other components as well as the packaging materials.

Please go to <http://csr.asus.com/english/Takeback.htm> for detail recycling information in different region.

1.1 Welcome!

Thank you for purchasing the ASUS® LCD monitor!

The latest widescreen LCD monitor from ASUS provides a crisper, broader, and brighter display, plus a host of features that enhance your viewing experience.

With these features, you can enjoy the convenience and delightful visual experience that the monitor brings to you!

1.2 Package contents

Check your package for the following items:

- ✓ LCD monitor
- ✓ 1 x Adapter
- ✓ 1 x Power cable
- ✓ 1 x VGA cable
- ✓ 1 x DVI-HDMI cable (Available for model VX238H)
- ✓ 1 x DVI cable (Available for model VX238T & VX238N)
- ✓ 1 x Audio cable (Available for model VX238H/T/S)
- ✓ 1 x Quick start guide
- ✓ 1 x Warranty card



If any of the above items is damaged or missing, contact your retailer immediately.

1.3 Monitor introduction



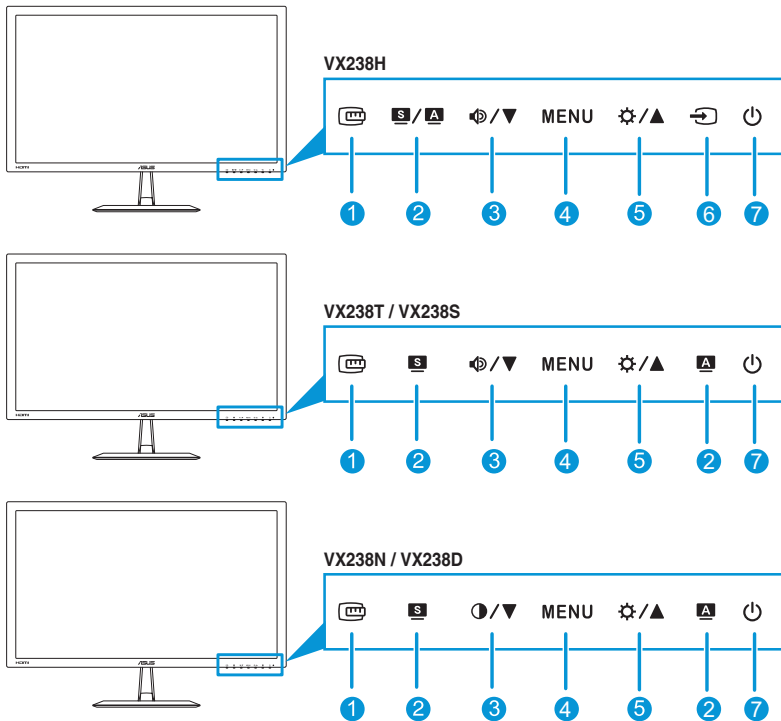



1.3.1 Front view









1.  Button:

- Activates the QuickFit function. (Please refer to 1.3.3 QuickFit function).

2.    Button:

- Selects a desired preset mode. ( )
- Exit the OSD menu or go back to the previous menu as the OSD menu is active. ( )
- Automatically adjusts the image to its optimized position, clock, and phase by pressing this button for 2~4 seconds (for VGA mode only). ( )

3.  /  Button:
 - Decreases values or moves your selection left/down.
 - Volume hotkey ()
 - Contrast hotkey ()
4. MENU Button:
 - Turns on the OSD menu.
 - Enacts the selected OSD menu item.
 - Press this button for 5 seconds to activate the Key Lock function. Press it again for 5 seconds to deactivate the function.
5.  /  Button:
 - Increases values or moves your selection right/up.
 - Brightness hotkey
6.  Input Select Button:
 - Selects an available input source.



Press  (Input Select button) to display HDMI signals after you connect HDMI cable with the monitor. (Available for model VX238H only)

7.  Power Button/Power Indicator:
 - Press this button to turn the monitor on/off.
 - The color definition of the power indicator is as the table below.

Status	Description
White	ON
Amber	Standby mode
OFF	OFF

1.3.2 Back view

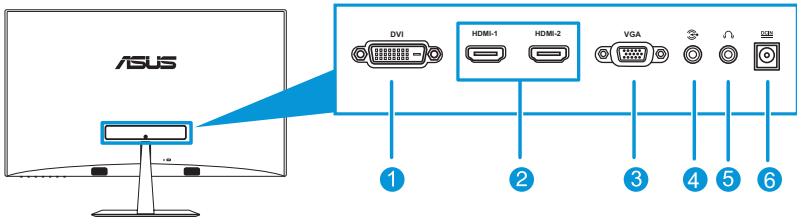

1. **DVI port** (Available for model VX238T and VX238N): This 24-pin port is for PC (Personal Computer) DVI-D digital signal connection.
2. **HDMI port** (Available for model VX238H): This port is for connection with an HDMI compatible device.
3. **VGA port**: This 15-pin port is for PC VGA connection.
4. **Audio-in port**: This port connects PC audio source by the bundled audio cable.
5. **Earphone jack** (Available for model VX238H only): This port connects to an earphone.
6. **DC-in port**: This port connects the adapter.

1.3.3 QuickFit Function

The QuickFit function allows users to have a preview of the document or photo layout directly on screen without printing test copies.

To activate QuickFit, press the QuickFit hotkey repeatedly to switch between different pattern sizes.

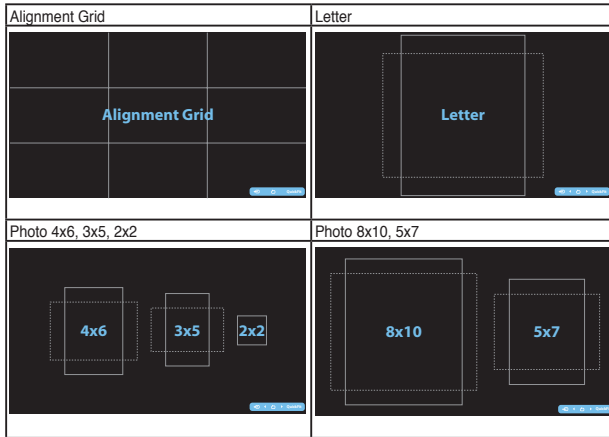

When QuickFit is activated, press the control buttons on the front panel to make adjustments. The QuickFit OSD displayed in the lower right corner of the screen will guide users to make selections.



2.1 Assembling the monitor base

To assemble the monitor base:

1. Have the front of the monitor face down on a table.
2. Attach the base to the arm and fix with the screw to join them tightly. You can easily tighten the screw by fingers.
3. Adjust the monitor to the angle that is most comfortable for you.



We recommend that you cover the table surface with soft cloth to prevent damage to the monitor.

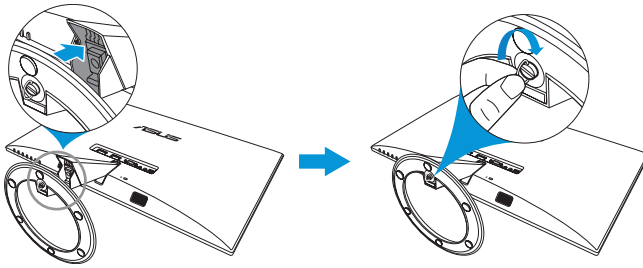

2.2 Adjusting the monitor

- For optimal viewing, we recommend that you look at the full face of the monitor, then adjust the monitor to the angle that is most comfortable for you.
- Hold the stand to prevent the monitor from falling while changing its angle.
- You can adjust the monitor's angle from -5° to 20° .



It is normal that the monitor slightly shakes while you adjust the viewing angle.

2.3 Connecting the cables

Connect the cables according to the following instructions:

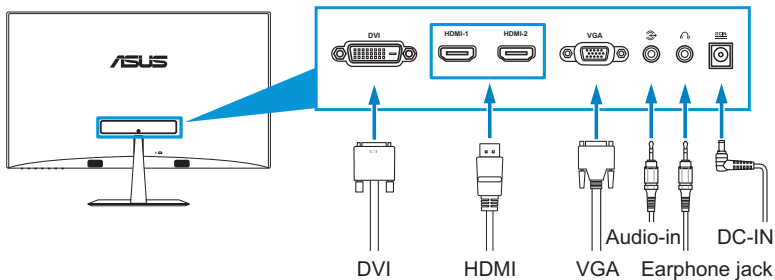



- **To connect the audio cable:** connect one end of the audio cable to the monitor's Audio-in port, the other end to the computer's audio-out port.
- **To connect the power cord:**
 - a. Connect the adapter to the monitor's DC input.
 - b. Connect one end of the power cable to the adapter, and the other end to a power outlet.
- **To connect the VGA/DVI/HDMI cable:**
 - a. Plug one end of the VGA/DVI/HDMI cable to the monitor's VGA/DVI/HDMI port.
 - b. Connect the other end of the VGA/DVI/HDMI cable to your computer's VGA/DVI/HDMI port.
 - c. Tighten the two screws to secure the VGA/DVI connector.
- **To use the earphone:** connect the end with plug type to the monitor's earphone jack.



For VX238H/T/N models, when multiple video signal cables are connected, you can choose the desired signal by pressing the  Input Select key (for VX238H) or select from the Input Select item in the OSD menu.

2.4 Turning on the monitor

Press the power button . See page 1-2 for the location of the power button. The power indicator  lights up in white to show that the monitor is ON.

3.1 OSD (On-Screen Display) menu

3.1.1 How to reconfigure

1. Press the MENU button to activate the OSD menu.
2. Press \leftarrow/∇ and $\rightarrow/\blacktriangle$ to navigate through the functions. Highlight and activate the desired function by pressing the MENU button. If the function selected has a sub-menu, press \leftarrow/∇ and $\rightarrow/\blacktriangle$ again to navigate through the sub-menu functions. Highlight and activate the desired sub-menu function by pressing the MENU button.
3. Press \leftarrow/∇ and $\rightarrow/\blacktriangle$ to change the settings of the selected function.
4. To exit the OSD menu, press the **S** button. Repeat step 2 and step 3 to adjust any other function.

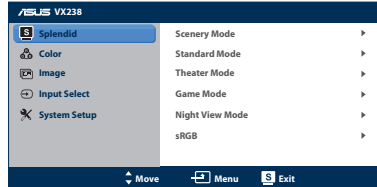

3.1.2 OSD Function Introduction

1. **Splendid**
This function contains six sub-functions that you can select for your preference. Each mode has the Reset selection, allowing you to maintain your setting or return to the preset mode.
 - **Scenery Mode:** best choice for scenery photo display with SPLENDID™ Video Enhancement.
 - **Standard Mode:** best choice for document editing with SPLENDID™ Video Enhancement.
 - **Theater Mode:** best choice for movies with SPLENDID™ Video Enhancement.
 - **Game Mode:** best choice for games playing with SPLENDID™ Video Enhancement.
 - **Night View Mode:** best choice for dark-scene games or movies with SPLENDID™ Video Enhancement.
 - **sRGB:** best choice for viewing photos and graphics from PCs.

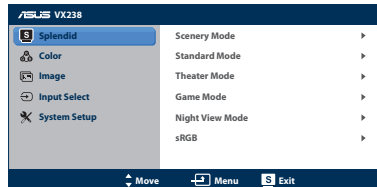



In the **Standard Mode**, the **Saturation**, **Skin Tone**, **Sharpness**, and **ASCR** functions are not user-configurable.

In the **sRGB**, the **Brightness**, **Contrast**, **Saturation**, **Color Temp.**, **Skin Tone**, **Sharpness**, and **ASCR** functions are not user-configurable.

2. Color

You can adjust Brightness, Contrast, Saturation, Color Temp., and Skin Tone from this menu.

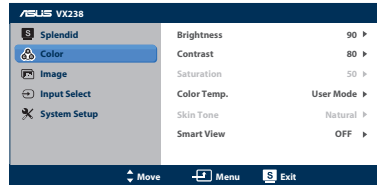

- **Brightness:** the adjusting range is from 0 to 100. / button is a hotkey to activate this function.
- **Contrast:** the adjusting range is from 0 to 100.
- **Saturation:** the adjusting range is from 0 to 100.
- **Color Temp.:** contains four modes including Cool, Normal, Warm and User Mode.
- **Skin Tone:** contains three color modes including Reddish, Natural, and Yellowish.
- **Smart View:** provides better display quality under big viewing angle.



In the **User Mode**, colors of **R (Red)**, **G (Green)**, and **B (Blue)** are user-configurable; the adjusting range is from 0 ~ 100.

3. Image

You can adjust Sharpness, Trace Free, Aspect Control, ASCR, Position (VGA only), and Focus (VGA only) from this menu.

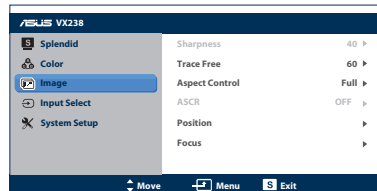

- **Sharpness:** the adjusting range is from 0 to 100.
- **Trace Free:** adjusts the response time of the monitor (only available in VX238H models)
- ∨ **Aspect Control** : adjust the aspect ratio to full, 4:3, 1:1 or OverScan



4:3 is only available when input source is in 4:3 format
OverScan is only available for the HDMI input source

- **ASCR:** turns on/off the ASCR (ASUS Smart Contrast Ratio) function.
- **Position:** adjusts the horizontal position (H-Position) and the vertical position (V-Position) of the image. The adjusting range is from 0 to 100 (only available for VGA input).

- **Focus:** reduces the Horizontal-line noise and Vertical-line noise of the image by adjusting (Phase) and (Clock) separately. The adjusting range is from 0 to 100.



- Phase adjusts the phase of the pixel clock signal. With a wrong phase adjustment, the screen shows horizontal disturbances.
- Clock (pixel frequency) controls the number of pixels scanned by one horizontal sweep. If the frequency is not correct, the screen shows vertical stripes and the image is not proportional.

4. Input Select

In this menu, you can select your desired input source: **VGA**, **DVI**, or **HDMI**.

- **DVI:** Available for model VX238T, VX238N only.
- **HDMI:** Available for model VX238H only.

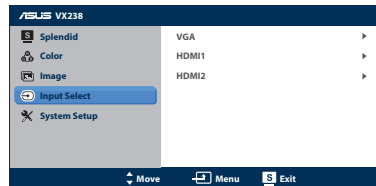

5. System Setup

Allows you to adjust the system.

- **Splendid Demo Mode:** splits the screen into two for Splendid mode comparison.
- **Volume:** Adjust the earphone output volume level. The adjusting range is from 0 to 100.
- **ECO Mode:** Activate the ecology mode for power saving. (Some gray levels may not be distinguished if ECO is ON. Its brightness is lower than that when setting the Contrast Ratio to 100.)
- **OSD Setup:** Adjust the horizontal position (H-Position), vertical position (V-Position), OSD Timeout, DDD/CI, and Transparency of the OSD screen.
- **Language:** Select OSD language. The selections are English, French, German, Spanish, Italian, Dutch, Russian, Traditional Chinese, Simplified Chinese, and Japanese.
- **Information:** Display the monitor information of Input Port, Resolution, H-freq., V-freq., and Model Name.
- **All Reset:** Set to “Yes” to revert all settings to the factory default status.

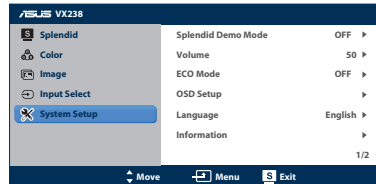

3.2 Specifications Summary

3.2.1 VX238H

Panel Type	TFT LCD
Panel Size	23" (16:9, 58.4 cm) wide screen
Max. Resolution	1920 x 1080
Brightness (Typ.)	250 cd/m ²
Contrast Ratio (Typ.)	1000:1
Contrast Ratio (Max.)	80,000,000:1 (w/DCR)
Viewing Angle (H/V) CR>10	170° / 160°
Display Colors	16.7 M
Response Time	1 ms
SPLENDID™ Video Enhancement	Yes
SPLENDID™ selection	6 video preset modes (by hotkey)
Auto adjustment	Yes (by hotkey)
Color temperature selection	4 color temperatures
Skin-Tone selection	3 skin tones
Digital input	HDMI v1.3 (x2)
Analog input	D-Sub
Audio-in port	3.5 mm Mini-jack
Earphone jack	Yes (only for HDMI)
Colors	Black
Speaker (Built-in)	2 x 1.5 W
Power LED	White (On) / Amber (Standby)
Tilt	-5° ~ +20°
Voltage Rating	100~240Vac, 50/60Hz, (AC adaptor: DELTA ELECTRONICS, INC. / ADP-40PH AB)
Power Consumption	Power On: < 34W, Standby: < 0.5 W, Power Off: < 0.5 W
Temperature (Operating)	0 ~ 40° C
Temperature (Non-operating)	-20 ~ 60° C
Dimensions (W x H x D)	548.2 x 402.7 x 210.0 mm (monitor) 600.0 x 488.0 x 125.0 mm (package)
Weight (Esti.)	2.6 ± 1.0 kg (Net), 4.1 ± 1.0 kg (Gross)

Multi-languages	21 languages (English, French, German, Spanish, Italian, Dutch, Russian, Poland, Czech, Croatia, Hungary, Romania, Portuguese, Turkey, Traditional Chinese, Simplified Chinese, Japanese, Korean Persian, Thai, Indonesian)
Accessories	Adapter, Power cable, VGA cable, DVI-HDMI cable, Audio cable, Quick Start Guide, Warranty card
Regulation approvals	UL/cUL, CB, CE, FCC, CCC, BSMI, Gost-R, c-Tick, VCCI, Windows Vista & 7 WHWL, EuP, RoHS, WEEE, EPEAT, HDMI, Energy Star® 5.1, China Energy Label

*Specifications subject to change without notice.

3.2.2 VX238T

Panel Type	TFT LCD
Panel Size	23" (16:9, 58.4 cm) wide screen
Max. Resolution	1920 x 1080
Brightness (Typ.)	250 cd/m ²
Contrast Ratio (Typ.)	1000:1
Contrast Ratio (Max.)	80,000,000:1 (w/DCR)
Viewing Angle (H/V) CR>10	170° / 160°
Display Colors	16.7 M
Response Time	5 ms
SPLendid™ Video Enhancement	Yes
SPLendid™ selection	6 video preset modes (by hotkey)
Auto adjustment	Yes (by hotkey)
Color temperature selection	4 color temperatures
Skin-Tone selection	3 skin tones
Digital input	DVI-D with HDCP
Analog input	D-Sub
Audio-in port	3.5 mm Mini-jack
Earphone jack	No
Colors	Black
Speaker (Built-in)	2 x 1.5 W
Power LED	White (On) / Amber (Standby)
Tilt	-5° ~ +20°
Voltage Rating	100~240Vac, 50/60Hz, (AC adaptor: DELTA ELECTRONICS, INC. / ADP-40PH AB)

Power Consumption	Power On: < 34W, Standby: < 0.5 W, Power Off: < 0.5 W
Temperature (Operating)	0 ~ 40° C
Temperature (Non-operating)	-20 ~ 60° C
Dimensions (W x H x D)	548.2 x 402.7 x 210.0 mm (monitor) 600.0 x 488.0 x 125.0 mm (package)
Weight (Esti.)	2.6 ± 1.0 kg (Net), 4.1 ± 1.0 kg (Gross)
Multi-languages	21 languages (English, French, German, Spanish, Italian, Dutch, Russian, Poland, Czech, Croatia, Hungary, Romania, Portuguese, Turkey, Traditional Chinese, Simplified Chinese, Japanese, Korean Persian, Thai, Indonesian)
Accessories	Adapter, Power cable, VGA cable, DVI cable, Audio cable, Quick Start Guide, Warranty card
Regulation approvals	UL/cUL, CB, CE, FCC, CCC, BSMI, Gost-R, c-Tick, VCCI, Windows Vista & 7 WHWL, EuP, RoHS, WEEE, EPEAT, HDMI, Energy Star® 5.1, China Energy Label

*Specifications subject to change without notice.

3.2.3 VX238S

Panel Type	TFT LCD
Panel Size	23" (16:9, 58.4 cm) wide screen
Max. Resolution	1920 x 1080
Brightness (Typ.)	250 cd/m ²
Contrast Ratio (Typ.)	1000:1; 80000000:1 (w/DCR)
Contrast Ratio (Max.)	80,000,000:1 (w/DCR)
Viewing Angle (H/V) CR>10	170° / 160°
Display Colors	16.7 M
Response Time	5 ms
SPLENDID™ Video Enhancement	Yes
SPLENDID™ selection	6 video preset modes (by hotkey)
Auto adjustment	Yes (by hotkey)
Color temperature selection	4 color temperatures
Skin-Tone selection	3 skin tones
Digital input	No
Analog input	D-Sub
Audio-in port	3.5 mm Mini-jack
Earphone jack	No

Colors	Black
Speaker (Built-in)	2 x 1.5 W
Power LED	White (On) / Amber (Standby)
Tilt	-5° ~ +20°
Voltage Rating	100~240Vac, 50/60Hz, (AC adaptor: DELTA ELECTRONICS, INC. / ADP-40PH AB)
Power Consumption	Power On: < 34W, Standby: < 0.5 W, Power Off: < 0.5 W
Temperature (Operating)	0 ~ 40° C
Temperature (Non-operating)	-20 ~ 60° C
Dimensions (W x H x D)	548.2 x 402.7 x 210.0 mm (monitor) 600.0 x 488.0 x 125.0 mm (package)
Weight (Esti.)	2.6 ± 1.0 kg (Net), 4.1 ± 1.0 kg (Gross)
Multi-languages	21 languages (English, French, German, Spanish, Italian, Dutch, Russian, Poland, Czech, Croatia, Hungary, Romania, Portuguese, Turkey, Traditional Chinese, Simplified Chinese, Japanese, Korean Persian, Thai, Indonesian)
Accessories	Adapter, Power cable, VGA cable, Audio cable, Quick Start Guide, Warranty card
Regulation approvals	UL/cUL, CB, CE, FCC, CCC, BSMI, Gost-R, c-Tick, VCCI, Windows Vista & 7 WHWL, EuP, RoHS, WEEE, EPEAT, HDMI, Energy Star® 5.1, China Energy Label

*Specifications subject to change without notice.

3.2.4 VX238N

Panel Type	TFT LCD
Panel Size	23" (16:9, 58.4 cm) wide screen
Max. Resolution	1920 x 1080
Brightness (Typ.)	250 cd/m ²
Contrast Ratio (Typ.)	1000:1; 80000000:1 (w/DCR)
Contrast Ratio (Max.)	80,000,000:1 (w/DCR)
Viewing Angle (H/V) CR>10	170° / 160°
Display Colors	16.7 M
Response Time	5 ms
SPLENDID™ Video Enhancement	Yes
SPLENDID™ selection	6 video preset modes (by hotkey)

Auto adjustment	Yes (by hotkey)
Color temperature selection	4 color temperatures
Skin-Tone selection	3 skin tones
Analog input	D-Sub
Colors	Black
Power LED	White (On) / Amber (Standby)
Tilt	-5° ~ +20°
Voltage Rating	100~240Vac, 50/60Hz, (AC adaptor: DELTA ELECTRONICS, INC. / ADP-40PH AB)
Power Consumption	Power On: < 34W, Standby: < 0.5 W, Power Off: < 0.5 W
Temperature (Operating)	0 ~ 40° C
Temperature (Non-operating)	-20 ~ 60° C
Dimensions (W x H x D)	548.2 x 402.7 x 210.0 mm (monitor) 600.0 x 488.0 x 125.0 mm (package)
Weight (Esti.)	2.6 ± 1.0 kg (Net), 4.1 ± 1.0 kg (Gross)
Multi-languages	21 languages (English, French, German, Spanish, Italian, Dutch, Russian, Poland, Czech, Croatia, Hungary, Romania, Portuguese, Turkey, Traditional Chinese, Simplified Chinese, Japanese, Korean Persian, Thai, Indonesian)
Accessories	Adapter, Power cable, VGA cable, Quick Start Guide, Warranty card
Regulation approvals	UL/cUL, CB, CE, FCC, CCC, BSMI, Gost-R, c-Tick, VCCI, Windows Vista & 7 WHWL, EuP, RoHS, WEEE, EPEAT, HDMI, Energy Star® 5.1, China Energy Label

*Specifications subject to change without notice.







3.2.5 VX238D

Panel Type	TFT LCD
Panel Size	23" (16:9, 58.4 cm) wide screen
Max. Resolution	1920 x 1080
Brightness (Typ.)	250 cd/m ²
Contrast Ratio (Typ.)	1000:1; 80000000:1 (w/DCR)
Contrast Ratio (Max.)	80,000,000:1 (w/DCR)
Viewing Angle (H/V) CR>10	170° / 160°
Display Colors	16.7 M

Response Time	5 ms
SPLENDID™ Video Enhancement	Yes
SPLENDID™ selection	6 video preset modes (by hotkey)
Auto adjustment	Yes (by hotkey)
Color temperature selection	4 color temperatures
Skin-Tone selection	3 skin tones
Analog input	D-Sub
Colors	Black
Power LED	White (On) / Amber (Standby)
Tilt	-5° ~ +20°
Voltage Rating	100~240Vac, 50/60Hz, (AC adaptor: DELTA ELECTRONICS, INC. / ADP-40PH AB)
Power Consumption	Power On: < 34W, Standby: < 0.5 W, Power Off: < 0.5 W
Temperature (Operating)	0 ~ 40° C
Temperature (Non-operating)	-20 ~ 60° C
Dimensions (W x H x D)	548.2 x 402.7 x 210.0 mm (monitor) 600.0 x 488.0 x 125.0 mm (package)
Weight (Esti.)	2.6 ± 1.0 kg (Net), 4.1 ± 1.0 kg (Gross)
Multi-languages	21 languages (English, French, German, Spanish, Italian, Dutch, Russian, Poland, Czech, Croatia, Hungary, Romania, Portuguese, Turkey, Traditional Chinese, Simplified Chinese, Japanese, Korean Persian, Thai, Indonesian)
Accessories	Adapter, Power cable, VGA cable, Quick Start Guide, Warranty card
Regulation approvals	UL/cUL, CB, CE, FCC, CCC, BSMI, Gost-R, c-Tick, VCCI, Windows Vista & 7 WHWL, EuP, RoHS, WEEE, EPEAT, HDMI, Energy Star® 5.1, China Energy Label

*Specifications subject to change without notice.

3.3 Troubleshooting (FAQ)

Problem	Possible Solution
Power LED is not ON	<ul style="list-style-type: none"> • Press the  button to check if the monitor is in the ON mode. • Check if the adapter and power cable are properly connected to the monitor and the power outlet.
The power LED lights amber and there is no screen image	<ul style="list-style-type: none"> • Check if the monitor and the computer are in the ON mode. • Make sure the signal cable is properly connected the monitor and the computer. • Inspect the signal cable and make sure none of the pins are bent. • Connect the computer with another available monitor to check if the computer is properly working.
Screen image is too light or dark	<ul style="list-style-type: none"> • Adjust the Contrast and Brightness settings via OSD.
Screen image is not centered or sized properly	<ul style="list-style-type: none"> • Press the  /  or  button for two seconds to automatically adjust the image. • Adjust the H-Position or V-Position settings via OSD.
Screen image bounces or a wave pattern is present in the image	<ul style="list-style-type: none"> • Make sure the signal cable is properly connected to the monitor and the computer. • Move electrical devices that may cause electrical interference.
Screen image has color defects (white does not look white)	<ul style="list-style-type: none"> • Inspect the signal cable and make sure that none of the pins are bent. • Perform Reset via OSD. • Adjust the R/G/B color settings or select the Color Temperature via OSD.
Screen image is blurry or fuzzy	<ul style="list-style-type: none"> • Press the  /  or  button for two seconds to automatically adjust the image (for VGA mode only). • Adjust the Phase and Clock settings via OSD.
No sound or sound is low	<ul style="list-style-type: none"> • Make sure the audio cable is properly connected to the monitor. • Adjust the volume settings of both your monitor and computer. • Make sure the computer sound card driver is properly installed and activated.

3.4 Supported operating modes

Mode	Resolution	Refresh Rate	Horizontal Frequency (KHz)	Vertical Frequency (Hz)	Pixel (MHz)
DOS	720x400@70Hz	900x449	31.469	70.087	28.322
VGA	640x480@60Hz	800 x 525	31.469	59.940	25.175
	640x480@72Hz	832 x 520	37.861	72.809	31.500
	640x480@75Hz	840x500	37.500	75.000	31.500
SVGA	800x600@56Hz	1024 x 625	35.156	56.250	36.000
	800x600@60Hz	1056 x 628	37.879	60.317	40.000
	800x600@72Hz	1040 x 666	48.077	72.188	50.000
	800x600@75Hz	1056 x 625	46.875	75.000	49.500
XGA	1024x768@60Hz	1344x806	48.363	60.004	65.000
	1024x768@70Hz	1328x806	56.476	70.069	75.000
	1024x768@75Hz	1312x800	60.023	75.029	78.750
VESA	1152x864@75Hz	1600x900	67.5	75.000	108.000
SXGA	1280x1024@60Hz	1688x1066	63.981	60.020	108.000
	1280x1024@75Hz	1688x1066	79.976	75.025	135.000
	1280x960@60Hz	1800x1000	60.000	60.000	108.000
WXGA	1280x800@60Hz	1680x831	49.702	59.810	83.500
	1280x720@60Hz	1650x750	45.00	60.000	74.25
	1280x768@60Hz	1664x798	47.776	59.870	79.5
	1360x768@60Hz	1792x795	47.712	60.015	85.500
	1366x768@60Hz	1792x798	47.712	59.790	85.500
WXGA+	1440x900@60Hz	1904x934	55.935	59.887	106.500
UXGA	1600x1200@60Hz	2160x1250	75.000	60.000	162.000
WSXGA+	1680x1050@60Hz	2240*1089	65.290	59.954	146.250
WUXGA	1920x1080@60Hz	2576x1120	67.158	59.963	173.000
	1920x1080@60Hz	2200x1125	67.500	60.000	148.500
	1920x1080@60Hz	2080x1111	66.587	59.934	138.500
MAC	640x480@66.66Hz	864x525	35	66.66	30.24
SVGA	832x624@75Hz	1152x667	49.714	74.533	57.27

* Modes not listed in the table may not be supported. For optimal resolution, we recommend that you choose a mode listed in the table above.

* This monitor supports full HD (480p, 576p, 720p, 1080i/p) video content from game consoles, DVD players and other consumer video devices via HDMI.