

FUJIFILM

BL04101-100 **EN**

DIGITAL CAMERA

X-E2

Owner's Manual

Thank you for your purchase of this product. This manual describes how to use your FUJIFILM X-E2 digital camera and install the supplied software. Be sure that you have read and understood its contents before using the camera.

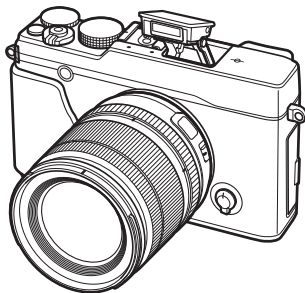

For information on related products, visit our website at http://www.fujifilm.com/products/digital_cameras/index.html

For more information on the X-E2, visit <http://fujifilm-x.com/x-e2/>

Before You Begin

First Steps

Basic Photography
and Playback

Basic Movie Recording
and Playback

The Q (Quick Menu) Button

More on Photography
and Playback

Menus

Connections

Technical Notes

Troubleshooting

Appendix



IMPORTANT SAFETY INSTRUCTIONS

- **Read Instructions:** All the safety and operating instructions should be read before the appliance is operated.
- **Retain Instructions:** The safety and operating instructions should be retained for future reference.
- **Heed Warnings:** All warnings on the appliance and in the operating instructions should be adhered to.
- **Follow Instructions:** All operating and use instructions should be followed.

Installation

Power Sources: This video product should be operated only from the type of power source indicated on the marking label. If you are not sure of the type of power supply to your home, consult your appliance dealer or local power company. For video products intended to operate from battery power, or other sources, refer to the operating instructions.

Grounding or Polarization: This video product is equipped with a polarized alternating-current line plug (a plug having one blade wider than the other). This plug will fit into the power outlet only one way. This is a safety feature. If you are unable to insert the plug fully into the outlet, try reversing the plug. If the plug should still fail to fit, contact your electrician to replace your obsolete outlet. Do not defeat the safety purpose of the polarized plug.

Alternate Warnings: This video product is equipped with a three-wire grounding-type plug, a plug having a third (grounding) pin. This plug will only fit into a grounding-type power outlet. This is a safety feature. If you are unable to insert the plug into the outlet, contact your electrician to replace your obsolete outlet. Do not defeat the safety purpose of the grounding type plug.

Overloading: Do not overload wall outlets and extension cords as this can result in a risk of fire or electric shock.

Ventilation: Slots and openings in the cabinet are provided for ventilation, to ensure reliable operation of the video product and to protect it from overheating, and these openings must not be blocked or covered. The openings should never be blocked by placing the video product on a bed, sofa, rug, or other similar surface.

This video product should not be placed in a built-in installation such as a bookcase or rack unless proper ventilation is provided or the manufacturer's instructions have been adhered to. This video product should never be placed near or over a radiator or heat register.

Attachments: Do not use attachments not recommended by the video product manufacturer as they may cause hazards.

Water and Moisture: Do not use this video product near water—for example, near a bath tub, wash bowl, kitchen sink, or laundry tub, in a wet basement, or near a swimming pool, and the like.

Power-Cord Protection: Power-supply cords should be routed so that they are not likely to be walked on or pinched by items placed upon or against them, paying particular attention to cords at plugs, convenience receptacles, and the point where they exit from the appliance.

Accessories: Do not place this video product on an unstable cart, stand, tripod, bracket, or table. The video product may fall, causing serious injury to a child or adult, and serious damage to the appliance. Use only with a cart, stand, tripod, bracket, or table recommended by the manufacturer, or sold with the video product. Any mounting of the appliance should follow the manufacturer's instructions, and should use a mounting accessory recommended by the manufacturer.

An appliance and cart combination should be moved with care. Quick stops, excessive force, and uneven surfaces may cause the appliance and cart combination to overturn.



Antennas

Outdoor Antenna Grounding: If an outside antenna or cable system is connected to the video product, be sure the antenna or cable system is grounded so as to provide some protection against voltage surges and built-up static charges. Section 810 of the National Electrical Code, ANSI/NFPA No. 70, provides information with respect to proper grounding of the

mast and supporting structure, grounding of the lead-in wire to an antenna discharge unit, size of grounding conductors, location of antenna discharge unit, connection to grounding electrodes, and requirements for the grounding electrode.

EXAMPLE OF ANTENNA GROUNDING AS PER NATIONAL ELECTRICAL CODE

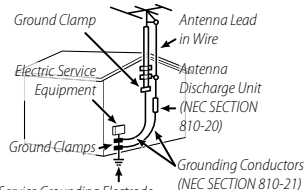

Power Service Grounding Electrode System (NEC ART 250, PART H)

Power Lines: An outside antenna system should not be located in the vicinity of overhead power lines or other electric light or power circuits, or where it can fall into such power lines or circuits. When installing an outside antenna system, extreme care should be taken to keep from touching such power lines or circuits as contact with them might be fatal.

Use

Cleaning: Unplug this video product from the wall outlet before cleaning. Do not use liquid cleaners or aerosol cleaners. Use a damp cloth for cleaning.

Object and Liquid Entry: Never push objects of any kind into this video product through openings as they may touch dangerous voltage points or short out parts that could result in a fire or electric shock. Never spill liquid of any kind on the video product.

Lightning: For added protection for this video product receiver during a lightning storm, or when it is left unattended and unused for long periods of time, unplug it from the wall outlet and disconnect the antenna or cable system. This will prevent damage to the video product due to lightning and power-line surges.

Service

Service: Do not attempt to service this video product yourself as opening or removing covers may expose you to dangerous voltage or other hazards. Refer all servicing to qualified service personnel.

Damage Requiring Service: Unplug this video product from the wall outlet and refer servicing to qualified service personnel under the following conditions:

- When the power-supply cord or plug is damaged
- If liquid has been spilled, or objects have fallen into the video product.
- If the video product has been exposed to rain or water.
- If the video product has been dropped or the cabinet has been damaged.

If the video product does not operate normally follow the operating instructions. Adjust only those controls that are covered by the operating instructions as an improper adjustment of other controls may result in damage and will often require extensive work by a qualified technician to restore the video product to its normal operation.

When the video product exhibits a distinct change in performance—this indicates a need for service.

Replacement Parts: When replacement parts are required, be sure the service technician has used replacement parts specified by the manufacturer or have the same characteristics as the original part. Unauthorized substitutions may result in fire, electric shock or other hazards.



Safety Check: Upon completion of any service or repairs to this video product, ask the service technician to perform safety checks to determine that the video product is in proper operating condition.

Be sure to read these notes before use**Safety Notes**



- Make sure that you use your camera correctly. Read these safety notes and your *Owner's Manual* carefully before use.
- After reading these safety notes, store them in a safe place.

About the Icons

The icons shown below are used in this document to indicate the severity of the injury or damage that can result if the information indicated by the icon is ignored and the product is used incorrectly as a result.

	WARNING	This icon indicates that death or serious injury can result if the information is ignored.
	CAUTION	This icon indicates that personal injury or material damage can result if the information is ignored.

The icons shown below are used to indicate the nature of the instructions which are to be observed.

	Triangular icons tell you that this information requires attention ("Important").
	Circular icons with a diagonal bar tell you that the action indicated is prohibited ("Prohibited").
	Filled circles with an exclamation mark indicate an action that must be performed ("Required").

WARNING

If a problem arises, turn the camera off, remove the battery, and disconnect and unplug the AC power adapter. Continued use of the camera when it is emitting smoke, is emitting any unusual odor, or is in any other abnormal state can cause a fire or electric shock. Contact your FUJIFILM dealer.

Do not allow water or foreign objects to enter the camera. If water or foreign objects get inside the camera, turn the camera off, remove the battery, and disconnect and unplug the AC power adapter. Continued use of the camera can cause a fire or electric shock. Contact your FUJIFILM dealer.

WARNING

Do not use in the bathroom or shower

Do not use the camera in the bathroom or shower.

This can cause a fire or electric shock.



Do not disassemble

Never attempt to change or take apart the camera (never open the case).

Failure to observe this precaution can cause fire or electric shock.

Should the case break open as the result of a fall or other accident, do not touch the exposed parts.

Failure to observe this precaution could result in electric shock or in injury from touching the damaged parts. Remove the battery immediately, taking care to avoid injury or electric shock, and take the product to the point of purchase for consultation.























Do not touch internal parts

Do not change, heat or unduly twist or pull the connection cord and do not place heavy objects on the connection cord.

These actions could damage the cord and cause a fire or electric shock. If the cord is damaged, contact your FUJIFILM dealer.

**Do not place the camera on an unstable surface.** This can cause the camera to fall or tip over and cause injury.**Never attempt to take pictures while in motion.** Do not use the camera while walking or driving. This can result in you falling down or being involved in a traffic accident.**Do not touch any metal parts of the camera during a thunderstorm.** This can cause an electric shock due to induced current from the lightning discharge.**Do not use the battery except as specified.** Load the battery as shown by the indicator.**Do not heat, change or take apart the battery. Do not drop or subject the battery to impacts. Do not store the battery with metallic products.** Any of these actions can cause the battery to burst or leak and cause fire or injury as a result.

 WARNING	
	Use only batteries or AC power adapters specified for use with this camera. Do not use voltages other than the power supply voltage shown. The use of other power sources can cause a fire.
	If the battery leaks and fluid gets in contact with your eyes, skin or clothing, flush the affected area with clean water and seek medical attention or call an emergency number right away.
	Do not use the charger to charge batteries other than those specified here. The supplied charger is for use only with batteries of the type supplied with the camera. Using the charger to charge conventional batteries or other types of rechargeable batteries can cause the battery to leak, overheat or burst.
	Do not use in the presence of flammable objects, explosive gases, or dust.
	When carrying the battery, install it in a digital camera or keep it in the hard case. When storing the battery, keep it in the hard case. When discarding, cover the battery terminals with insulation tape. Contact with other metallic objects or batteries could cause the battery to ignite or burst.
	Keep memory cards out of the reach of small children. Because memory cards are small, they can be swallowed by children. Be sure to store memory cards out of the reach of small children. If a child swallows a memory card, seek medical attention or call an emergency number.
 CAUTION	
	Do not use this camera in locations affected by oil fumes, steam, humidity or dust. This can cause a fire or electric shock.
	Do not leave this camera in places subject to extremely high temperatures. Do not leave the camera in locations such as a sealed vehicle or in direct sunlight. This can cause a fire.

 CAUTION	
	Keep out of the reach of small children. This product could cause injury in the hands of a child.
	Do not place heavy objects on the camera. This can cause the heavy object to tip over or fall and cause injury.
	Do not move the camera while the AC power adapter is still connected. Do not pull on the connection cord to disconnect the AC power adapter. This can damage the power cord or cables and cause a fire or electric shock.
	Do not cover or wrap the camera or the AC power adapter in a cloth or blanket. This can cause heat to build up and distort the casing or cause a fire.
	When you are cleaning the camera or you do not plan to use the camera for an extended period, remove the battery and disconnect and unplug the AC power adapter. Failure to do so can cause a fire or electric shock.
	When charging ends, unplug the charger from the power socket. Leaving the charger plugged into the power socket can cause a fire.
	Using a flash too close to a person's eyes may temporarily affect the eyesight. Take particular care when photographing infants and young children.
	When a memory card is removed, the card could come out of the slot too quickly. Use your finger to hold it and gently release the card. Injury could result to those struck by the ejected card.
	Request regular internal testing and cleaning for your camera. Build-up of dust in your camera can cause a fire or electric shock. Contact your FUJIFILM dealer to request internal cleaning every two years. Please note that this service is not free of charge.
	Danger of explosion if battery is incorrectly replaced. Replace only with the same or equivalent type.

The Battery and Power Supply

Note: Check the type of battery used in your camera and read the appropriate sections.

The following describes the proper use of batteries and how to prolong their life. Incorrect use can shorten battery life or cause leakage, overheating, fire, or explosion.

Li-ion Batteries

Read this section if your camera uses a rechargeable Li-ion battery.

The battery is not charged at shipment. Charge the battery before use. Keep the battery in its case when not in use.

■ Notes on the Battery

The battery gradually loses its charge when not in use. Charge the battery one or two days before use.

Battery life can be extended by turning the camera off when not in use.

Battery capacity decreases at low temperatures; a depleted battery may not function at when cold. Keep a fully charged spare battery in a warm place and exchange as necessary, or keep the battery in your pocket or other warm place and insert it in the camera only when shooting. Do not place the battery in direct contact with hand warmers or other heating devices.

■ Charging the Battery

Charge the battery in the supplied battery charger. Charging times will increase at ambient temperatures below +10°C (+50°F) or above +35°C (+95°F). Do not attempt to charge the battery at temperatures above 40°C (+104°F); at temperatures below 0°C (+32°F), the battery will not charge.

Do not attempt to recharge a fully charged battery. The battery does not however need to be fully discharged before charging.

The battery may be warm to the touch immediately after charging or use. This is normal.

Battery Life

At normal temperatures, the battery can be recharged about 300 times. A noticeable decrease in the length of time the battery will hold a charge indicates that it has reached the end of its service life and should be replaced.

Storage

Performance may be impaired if the battery is left unused for extended periods when fully charged. Run the battery flat before storing it.

If the camera will not be used for an extended period, remove the battery and store it in a dry place with an ambient temperature of from +15 °C to +25 °C (+59 °F to +77 °F). Do not store in locations exposed to extremes of temperature.

Cautions: Handling the Battery

- Do not transport or store with metal objects such as necklaces or hairpins.
- Do not expose to flame or heat.
- Do not disassemble or modify.
- Use with designated chargers only.
- Dispose of used batteries promptly.
- Do not drop or subject to strong physical shocks.
- Do not expose to water.
- Keep the terminals clean.
- The battery and camera body may become warm to the touch after extended use. This is normal.

AA Alkaline/Rechargeable Ni-MH Batteries

Read this section if your camera uses AA alkaline or rechargeable AA Ni-MH batteries. Information on compatible battery types may be found elsewhere in the camera manual.

Cautions: Handling the Batteries

- Do not expose to water, flame, or heat, or store in warm or humid conditions.
- Do not transport or store with metal objects such as necklaces or hairpins.
- Do not disassemble or modify the batteries or battery casing.
- Do not subject to strong physical shocks.

- Do not use batteries that are leaking, deformed, or discolored.
- Keep out of reach of infants and small children.
- Insert in the correct orientation.
- Do not mix old and new batteries, batteries with different charge levels, or batteries of different types.
- If the camera will not be used for an extended period, remove the batteries. Note that the camera clock will be reset.
- The batteries may be warm to the touch immediately after use. Turn the camera off and allow the batteries to cool before handling.
- Battery capacity tends to decrease at low temperatures. Keep spare batteries in a pocket or other warm place and exchange as necessary. Cold batteries may recover some of their charge when warmed.
- Fingerprints and other stains on the battery terminals can impair battery performance. Thoroughly clean the terminals with a soft, dry cloth before inserting them in the camera.



If the batteries leak, clean the battery compartment thoroughly before inserting new batteries.



If fluid from the battery comes into contact with skin or clothing, flush the affected area with water. **If fluid enters your eyes, immediately flush the affected area with water and seek medical attention. Do not rub your eyes. Failure to observe this precaution could result in permanent visual impairment.**

Ni-MH Batteries

The capacity of Ni-MH batteries may be temporarily reduced when new, after long periods of disuse, or if they are repeatedly recharged before being fully discharged. This is normal and does not indicate a malfunction. Capacity can be increased by repeatedly discharging the batteries using the discharge option in the camera setup menu and recharging them using a battery charger.

- ⓘ **CAUTION:** Do not use the discharge option with alkaline batteries.

The camera draws a small amount of current even when off. Ni-MH batteries that have been left in the camera for an extended period may be drawn down to the point that they no longer hold a charge. Battery performance may also drop if the batteries are run down in a device such as a flashlight. Use the discharge option in the camera setup menu to discharge Ni-MH batteries. Batteries that no longer hold a charge even after repeatedly being discharged and recharged have reached the end of their service life and must be replaced.

Ni-MH batteries can be recharged in a battery charger (sold separately). Batteries may become warm to the touch after charging. Refer to the instructions provided with the charger for more information. Use the charger with compatible batteries only.

Ni-MH batteries gradually lose their charge when not in use.

Disposal

Dispose of used batteries in accord with local regulations.

AC Power Adapters (Available Separately)

This section applies to all camera models. Use only FUJIFILM AC power adapters designated for use with this camera. Other adapters could damage the camera.

- The AC power adapter is for indoor use only.
- Be sure the DC plug is securely connected to the camera.
- Turn the camera off before disconnecting the adapter. Disconnect the adapter by the plug, not the cable.
- Do not use with other devices.
- Do not disassemble.
- Do not expose to high heat and humidity.
- Do not subject to strong physical shocks.
- The adapter may hum or become hot to the touch during use. This is normal.
- If the adapter causes radio interference, reorient or relocate the receiving antenna.

Using the Camera

- Do not aim the camera at extremely bright light sources, such as the sun in a cloudless sky. Failure to observe this precaution could damage the camera image sensor.
- Strong sunlight focused through the viewfinder may damage the panel of electronic viewfinder (EVF). Do not aim the electronic viewfinder at the sun.

Take Test Shots

Before taking photographs on important occasions (such as at weddings or before taking the camera on a trip), take a test shot and view the results to ensure that the camera is functioning normally. FUJIFILM Corporation can not accept liability for damages or lost profits incurred as a result of product malfunction.

Notes on Copyright

Unless intended solely for personal use, images recorded using your digital camera system cannot be used in ways that infringe copyright laws without the consent of the owner. Note that some restrictions apply to the photographing of stage performances, entertainments, and exhibits, even when intended purely for personal use. Users are also asked to note that the transfer of memory cards containing images or data protected under copyright laws is only permissible within the restrictions imposed by those copyright laws.

Handling

To ensure that images are recorded correctly, do not subject the camera to impact or physical shocks while images are being recorded.

Liquid Crystal

In the event that the display is damaged, care should be taken to avoid contact with liquid crystal. Take the urgent action indicated should any of the following situations arise:

- **If liquid crystal comes in contact with your skin**, clean the area with a cloth and then wash thoroughly with soap and running water.
- **If liquid crystal enters your eyes**, flush the affected eye with clean water for at least 15 minutes and then seek medical assistance.
- **If liquid crystal is swallowed**, rinse your mouth thoroughly with water. Drink large quantities of water and induce vomiting, then seek medical assistance.

Although the display is manufactured using extremely high-precision technology, it may contain pixels that are always lit or that do not light. This is not a malfunction, and images recorded with the product are unaffected.

Trademark Information

Digital Split Image is a trademark or registered trademark of FUJIFILM Corporation. **xD-Picture Card** and **.sd** are trademarks of FUJIFILM Corporation. The typefaces included herein are solely developed by DynaComware Taiwan Inc. Macintosh, QuickTime, and Mac OS are trademarks of Apple Inc. in the U.S.A. and other countries. Windows 8, Windows 7, Windows Vista, and the Windows logo are trademarks of the Microsoft group of companies. Wi-Fi® and Wi-Fi Protected Setup® are registered trademarks of the Wi-Fi Alliance. Adobe and Adobe Reader are either trademarks or registered trademarks of Adobe Systems Incorporated in the U.S.A. and/or other countries. The SDHC and SDXC logos are trademarks of SD-3C, LLC. The HDMI logo is a trademark. YouTube is a trademark of Google Inc. All other trade names mentioned in this manual are the trademarks or registered trademarks of their respective owners.

Electrical Interference

This camera may interfere with hospital or aviation equipment. Consult with hospital or airline staff before using the camera in a hospital or on an aircraft.

Color Television Systems

NTSC (National Television System Committee) is a color television telecasting specification adopted mainly in the U.S.A., Canada, and Japan. PAL (Phase Alternation by Line) is a color television system adopted mainly in European countries and China.

Electrical Interference

Exif Print is a newly revised digital camera file format in which information stored with photographs is used for optimal color reproduction during printing.

IMPORTANT NOTICE: Read Before Using the Software

Direct or indirect export, in whole or in part, of licensed software without the permission of the applicable governing bodies is prohibited.

NOTICES

To prevent fire or shock hazard, do not expose the unit to rain or moisture.

Please read the "Safety Notes" and make sure you understand them before using the camera.

Perchlorate Material—special handling may apply. See <http://www.dtsc.ca.gov/hazardouswaste/perchlorate>.

For Customers in the U.S.A.**Tested To Comply With FCC Standards****FOR HOME OR OFFICE USE**

Contains IC: 7736B-02000002

Contains FCC ID: W22-02000002

FCC Statement: This device complies with Part 15 of the FCC Rules. Operation is subject to the following two conditions: (1) This device may not cause harmful interference, and (2) this device must accept any interference received, including interference that may cause undesired operation.

CAUTION: This equipment has been tested and found to comply with the limits for a Class B digital device, pursuant to Part 15 of the FCC Rules. These limits are designed to provide reasonable protection against harmful interference in a residential installation. This equipment generates, uses, and can radiate radio frequency energy and, if not installed and used in accordance with the instructions, may cause harmful interference to radio communications. However, there is no guarantee that interference will not occur in a particular installation. If this equipment does cause harmful interference to radio or television reception, which can be determined by turning the equipment off and on, the user is encouraged to try to correct the interference by one or more of the following measures:

- Reorient or relocate the receiving antenna.
- Increase the separation between the equipment and receiver.
- Connect the equipment into an outlet on a circuit different from that to which the receiver is connected.
- Consult the dealer or an experienced radio/TV technician for help.

FCC Caution: Any changes or modifications not expressly approved by the party responsible for compliance could void the user's authority to operate this equipment.

This transmitter must not be co-located or operating in conjunction with any other antenna or transmitter.

Radiation Exposure Statement: This device meets the government's requirements for exposure to radio waves. This device is designed and manufactured not to exceed the emission limits for exposure to radio frequency (RF) energy set by the Federal Communications Commission of the U.S. Government.

The exposure standard for wireless device employs a unit of measurement known as the Specific Absorption Rate, or SAR. The SAR limit set by the FCC is 1.6W/kg. *Tests for SAR are conducted using standard operating positions accepted by the FCC with the device transmitting at its highest certified power level in all tested frequency bands.

Notes on the Grant: To comply with Part 15 of the FCC Rules, this product must be used with a Fujifilm-specified ferrite-core A/V cable, USB cable, and DC supply cord.



A lithium ion battery that is recyclable powers the product you have purchased. Please call 1-800-8-BATTERY for information on how to recycle this battery.

For Customers in Canada**CAN ICES-3 (B)/NMB-3(B)**

CAUTION: This Class B digital apparatus complies with Canadian ICES-003.

Industry Canada statement: This device complies with RSS-210 of the Industry Canada Rules. Operation is subject to the following two conditions: (1) This device may not cause harmful interference, and (2) this device must accept any interference received, including interference that may cause undesired operation.

This device and its antenna(s) must not be co-located or operating in conjunction with any other antenna or transmitter, except tested built-in radios. The County Code Selection feature is disabled for products marketed in the US/ Canada.

Radiation Exposure Statement: The product comply with the Canada portable RF exposure limit set forth for an uncontrolled environment and are safe for intended operation as described in this manual. The further RF exposure reduction can be achieved if the product can be kept as far as possible from the user body or set the device to lower output power if such function is available.

Disposal of Electrical and Electronic Equipment in Private Households**In the European Union, Norway, Iceland and**

Liechtenstein: This symbol on the product, or in the manual and in the warranty, and/or on its packaging indicates that this product shall not be treated as household waste. Instead it should be taken to an applicable collection point for the recycling of electrical and electronic equipment.



By ensuring this product is disposed of correctly, you will help prevent potential negative consequences to the environment and human health, which could otherwise be caused by inappropriate waste handling of this product.

This symbol on the batteries or accumulators indicates that those batteries shall not be treated as household waste.



If your equipment contains easy removable batteries or accumulators please dispose these separately according to your local requirements.

The recycling of materials will help to conserve natural resources. For more detailed information about recycling this product, please contact your local city office, your household waste disposal service or the shop where you purchased the product.

In Countries Outside the European Union, Norway, Iceland and

Liechtenstein: If you wish to discard this product, including the batteries or accumulators, please contact your local authorities and ask for the correct way of disposal.

In Japan: This symbol on the batteries indicates that they are to be disposed of separately.



Be sure to read these notes before use



Safety Notes

Thank you for your purchase of this product. For repair, inspection, and internal testing, contact your FUJIFILM dealer.



- Make sure that you use the lens correctly. Read these safety notes and the camera *Owner's Manual* carefully before use.
- After reading these safety notes, store them in a safe place.

About the Icons



The icons shown below are used in this document to indicate the severity of the injury or damage that can result if the information indicated by the icon is ignored and the product is used incorrectly as a result.

	WARNING	This icon indicates that death or serious injury can result if the information is ignored.
	CAUTION	This icon indicates that personal injury or material damage can result if the information is ignored.



The icons shown below are used to indicate the nature of the instructions which are to be observed.

	Triangular icons tell you that this information requires attention ("Important").
	Circular icons with a diagonal bar tell you that the action indicated is prohibited ("Prohibited").
	Filled circles with an exclamation mark indicate an action that must be performed ("Required").







WARNING

	Do not immerse in or expose to water. Failure to observe this precaution can cause a fire or electric shock.
	Do not disassemble (do not open the case). Failure to observe this precaution can cause fire, electric shock, or injury due to product malfunction.
	Should the case break open as the result of a fall or other accident, do not touch the exposed parts. Failure to observe this precaution could result in electric shock or in injury from touching the damaged parts. Remove the camera battery immediately, taking care to avoid injury or electric shock, and take the product to the point of purchase for consultation.

WARNING

-  **Do not place on unstable surfaces.** The product may fall, causing injury.
-  **Do not view the sun through the lens or camera viewfinders.** Failure to observe this precaution can cause permanent visual impairment.

CAUTION

-  **Do not use or store in locations that are exposed to steam, or smoke or are very humid or extremely dusty.** Failure to observe this precaution can cause fire or electric shock.
-  **Do not leave in direct sunlight or in locations subject to very high temperatures, such as in a closed vehicle on a sunny day.** Failure to observe this precaution can cause fire.
-  **Keep out of the reach of small children.** This product could cause injury in the hands of a child.
-  **Do not handle with wet hands.** Failure to observe this precaution can cause electric shock.
-  **Keep the sun out of the frame when shooting backlit subjects.** Sunlight focused into the camera when the sun is in or close to the frame can cause fire or burns.
-  **When the product is not in use, replace the lens caps and store out of direct sunlight.** Sunlight focused by the lens can cause fire or burns.
-  **Do not carry the camera or lens while they are attached to a tripod.** The product can fall or strike other objects, causing injury.

European Union regulatory notice

This product complies with the following EU Directives:

- Low Voltage Directive 2006/95/EC
- EMC Directive 2004/108/EC
- R & TTE Directive 1999/5/EC

Compliance with these directives implies conformity to applicable harmonized European standards (European Norms) which are listed on the EU Declaration of Conformity issued by FUJIFILM Corporation for this product or product family.

This compliance is indicated by the following conformity marking placed on the product:



This marking is valid for non-Telecom products and EU harmonized Telecom products (e.g. Bluetooth).

Regarding the Declaration of Conformity, visit http://www.fujifilm.com/products/digital_cameras/x/fujifilm_x_e2/pdf/index/fujifilm_x_e2_cod.pdf.

IMPORTANT: Read the following notices before using the camera's built-in wireless transmitter.

- ① This product, which contains encryption function developed in the United States, is controlled by the United States Export Administration Regulations and may not be exported or re-exported to any country to which the United States embargoes goods.
- **Use only as part of a wireless network.** FUJIFILM does not accept liability for damages resulting from unauthorized use. Do not use in applications requiring a high degree of reliability, for example in medical devices or other systems that may directly or indirectly impact human life. When using the device in computer and other systems that demand a greater degree of reliability than wireless networks, be sure to take all necessary precautions to ensure safety and prevent malfunction.
- **Use only in the country in which the device was purchased.** This device conforms to regulations governing wireless network devices in the country in which it was purchased. Observe all location regulations when using the device. FUJIFILM does not accept liability for problems arising from use in other jurisdictions.
- **Wireless data (images) may be intercepted by third parties.** The security of data transmitted over wireless networks is not guaranteed.
- **Do not use the device in locations subject to magnetic fields, static electricity, or radio interference.** Do not use the transmitter in the vicinity of microwave ovens or in other locations subject to magnetic fields, static electricity, or radio interference that may prevent reception of wireless signals. Mutual interference may occur when the transmitter is used in the vicinity of other wireless devices operating in the 2.4 GHz band.
- **The wireless transmitter operates in the 2.4 GHz band using DSSS and OFDM modulation.**

Wireless Network Devices: Cautions

- **This device operates on the same frequency as commercial, educational, and medical devices and wireless transmitters.** It also operates on the same frequency as licensed transmitters and special unlicensed low-voltage transmitters used in RFID tracking systems for assembly lines and in other similar applications.
- **To prevent interference with the above devices, observe the following precautions.** Confirm that the RFID transmitter is not in operation before using this device. Should you observe that the device causes interference in licensed transmitters used for RFID tracking, immediately choose a new operating frequency for this device to prevent additional interference. If you notice that this device causes interference in low-voltage RFID tracing systems, contact a FUJIFILM representative.



This sticker indicates that this device operates in the 2.4 GHz band using DSSS and OFDM modulation and may cause interference at distances of up to 40 m.

About This Manual

Before using the camera, read this manual and the warnings in “For Your Safety” (📖 ii). For information on specific topics, consult the sources below.

Table of Contents 📖 **xiii**

The “Table of Contents” gives an overview of the entire manual. The principal camera operations are listed here.

Troubleshooting 📖 **113**

Having a specific problem with the camera? Find the answer here.

Warning Messages and Displays 📖 **118**

Find out what’s behind that flashing icon or error message in the display.

Restrictions on Camera Settings..... 📖 **127**

See page 127 for restrictions on the options available in each shooting mode.

Memory Cards

Pictures are stored on optional SD, SDHC, and SDXC memory cards (📖 17), referred to in this manual as “memory cards.”

Product Care

Camera body: For continued enjoyment of your camera, use a soft, dry cloth to clean the camera body after each use. Do not use alcohol, thinner, or other volatile chemicals, which could discolor or deform the leather on the camera body. Any liquid on the camera should be removed immediately with a soft, dry cloth. Use a blower to remove dust from the monitor, taking care to avoid scratches, and then gently wipe with a soft, dry cloth. Any remaining stains can be removed by wiping gently with a piece of FUJIFILM lens-cleaning paper to which a small amount of lens-cleaning fluid has been applied. To prevent dust entering the camera, replace the body cap when no lens is in place.

Image sensor: Dust can be removed from the image sensor using the  **SENSOR CLEANING** option in the setup menu ( 91).

Interchangeable lenses: Use a blower to remove dust, then gently wipe with a soft, dry cloth. Any remaining stains can be removed by wiping gently with a piece of FUJIFILM lens-cleaning paper to which a small amount of lens-cleaning fluid has been applied. Replace the front and rear caps when the lens is not use.

Table of Contents

For Your Safety.....	ii
IMPORTANT SAFETY INSTRUCTIONS.....	ii
Safety Notes.....	iii
NOTICES.....	vi
Safety Notes.....	viii
About This Manual.....	x
Product Care.....	xi
Before You Begin	
Symbols and Conventions.....	1
Supplied Accessories.....	1
Parts of the Camera.....	2
The Selector.....	4
The Command Dial.....	4
Camera Displays.....	5
Shooting: Viewfinder/LCD Monitor.....	5
Shooting: LCD Monitor.....	6
Playback: Viewfinder/LCD Monitor.....	6
Lenses.....	7
Parts of the Lens.....	7
Removing the Caps.....	7
Attaching the Hood.....	7
Lenses with Aperture Rings.....	8
Lenses with No Aperture Rings.....	8
Lenses with O.I.S. Switches.....	9
Manual Focus Lenses.....	9

First Steps

Attaching the Strap.....	10
Attaching a Lens.....	12
Charging the Battery.....	13
Inserting the Battery and a Memory Card.....	14
Compatible Memory Cards.....	17
Turning the Camera on and Off.....	18
Basic Setup.....	19
Choosing a Display.....	20
Focusing the Viewfinder.....	21
Adjusting Display Brightness.....	21
The DISP/BACK Button.....	22
Viewfinder: Shooting.....	22
LCD Monitor: Shooting.....	22
Viewfinder/LCD Monitor: Playback.....	23

Basic Photography and Playback



































Taking Photographs.....	24
Viewing Pictures.....	26
Viewing Pictures Full Frame.....	26
Viewing Photo Information.....	27
Playback Zoom.....	27
Multi-Frame Playback.....	28
Deleting Pictures.....	29
Using the Flash.....	30
Macro Mode (Close-ups).....	32

Basic Movie Recording and Playback		
Recording High-Definition (HD) Movies	33	
Using an External Microphone	34	
Viewing Movies	35	
The Q (Quick Menu) Button		
More on Photography and Playback		
Choosing an Exposure Mode	37	
Program AE (P)	37	
Shutter-Priority AE (S)	38	
Aperture-Priority AE (A).....	39	
Manual Exposure (M).....	40	
Long Time-Exposures (T/B).....	41	
Time (T).....	41	
Bulb (B).....	41	
Using a Remote Release.....	42	
White Balance	43	
Sensitivity	45	
AUTO	46	
Focus Mode	47	
The Focus Indicator.....	48	
MF Assist.....	49	
Focus Frame Selection	50	
Focus/Exposure Lock	51	
Exposure Compensation.....	53	
Metering	54	
Using the Self-Timer.....	55	
Continuous Shooting (Burst Mode).....	57	
Bracketing.....	58	
Panoramas	59	
Viewing Panoramas	61	
Multiple Exposures	62	
Advanced Filter	63	
Film Simulation	64	
Recording Pictures in RAW Format	65	
Creating JPEG Copies of RAW Pictures	66	
Function Buttons	67	
Saving Settings.....	68	
Using a Mount Adapter	69	
Mount Adapter Settings.....	69	
Choosing a Focal Length	69	
Distortion Correction	69	
Color Shading Correction	70	
Peripheral Illumination Correction	70	
Image Search	71	
PhotoBook Assist.....	72	
Creating a PhotoBook.....	72	
Viewing Photobooks	73	
Editing and Deleting Photobooks.....	73	

Menus

Using the Menus: Shooting Mode	74
Shooting Menu Options (Photographs)	74
ISO	74
IMAGE SIZE	74
IMAGE QUALITY	74
DYNAMIC RANGE	75
FILM SIMULATION	75
FILM SIMULATION BKT	75
SELF-TIMER	75
WB WHITE BALANCE	75
COLOR	75
SHARPNESS	75
HIGHLIGHT TONE	75
SHADOW TONE	75
NR NOISE REDUCTION	76
LONG EXPOSURE NR	76
LMO LENS MODULATION OPTIMIZER	76
SELECT CUSTOM SETTING	76
EDIT/SAVE CUSTOM SETTING	76
DISP. CUSTOM SETTING	76
MOUNT ADAPTOR SETTING	77
SHOOT WITHOUT LENS	77
AF ILLUMINATOR	77

AF MODE	77
FACE DETECTION	77
FOCUS AREA	78
PRE-AF	78
PHOTOMETRY	78
AE/AF-LOCK MODE	78
AF-LOCK BUTTON	78
WIRELESS COMMUNICATION	78
FLASH MODE	78
FLASH COMPENSATION	78
RED EYE REMOVAL	79
IS MODE	79
APERTURE SETTING	79
MF ASSIST	79
Shooting Menu Options (Movie Mode)	80
MOVIE MODE	80
FACE DETECTION	80
FILM SIMULATION	80
WB WHITE BALANCE	80
MIC LEVEL ADJUSTMENT	80
MIC/REMOTE RELEASE	80
DISP. CUSTOM SETTING	80
IS MODE	80
APERTURE SETTING	80

Using the Menu: Playback Mode	81	The Setup Menu	87
Playback Menu Options	81	Using the Setup Menu	87
 WIRELESS COMMUNICATION.....	81	Setup Menu Options	88
 RAW CONVERSION.....	81	 DATE/TIME.....	88
 ERASE.....	81	 TIME DIFFERENCE.....	88
 CROP.....	82	 言語/LANG.....	88
 RESIZE.....	82	 RESET.....	88
 PROTECT.....	83	 SILENT MODE.....	88
 IMAGE ROTATE.....	83	 SOUND SET-UP.....	89
 RED EYE REMOVAL.....	84	 SCREEN SET-UP.....	89
 SLIDE SHOW.....	84	 FOCUS RING.....	90
 PHOTOBOK ASSIST.....	85	 FUNCTION (Fn) SETTING.....	90
 MARK FOR UPLOAD TO.....	85	 POWER MANAGEMENT.....	91
 IMAGE SEARCH.....	85	 SENSOR CLEANING.....	91
 PC AUTO SAVE.....	86	 FRAME NO.....	91
 PRINT ORDER (DPOF).....	86	 COLOR SPACE.....	92
 DISP ASPECT.....	86	 EVF/LCD SETTING.....	92
		 WIRELESS SETTINGS.....	92
		 PC AUTO SAVE SETTING.....	92
		 GEOTAGGING SET-UP.....	92
		 SAVE ORG IMAGE.....	92
		 FORMAT.....	92
		Factory Defaults	93

Connections		Technical Notes	
Wireless Transfer	95	Optional Accessories	107
Wireless Connections: Smartphones	95	Accessories from FUJIFILM	107
Wireless Connections: Computers	95	Connecting the Camera to Other Devices	110
Viewing Pictures on a Computer	96	Caring for the Camera	111
Windows: Installing MyFinePix Studio	96	Storage and Use	111
Macintosh: Installing RAW FILE CONVERTER	98	Traveling	111
Macintosh: Importing Pictures	98	Cleaning the Image Sensor	112
Connecting the Camera	99		
Printing Pictures via USB	101	Troubleshooting	
Connecting the Camera	101	Problems and Solutions	113
Printing Selected Pictures	101	Warning Messages and Displays	118
Printing the DPOF Print Order	102		
Creating a DPOF Print Order	103	Appendix	
WITH DATE  / WITHOUT DATE	104	Memory Card Capacity	121
RESET ALL	105	Specifications	122
Viewing Pictures on TV	106	Restrictions on Camera Settings	127

Before You Begin

Symbols and Conventions

The following symbols are used in this manual:

- ⓘ This information should be read before use to ensure correct operation.
- ◆ Additional information that may be helpful when using the camera.
- 📖 Other pages in this manual on which related information may be found.

Menus and other text in the displays are shown in **bold**. In the illustrations in this manual, displays may be simplified for explanatory purposes.

Supplied Accessories

The following items are included with the camera:



NP-W126 rechargeable battery

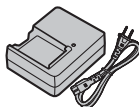

BC-W126 battery charger

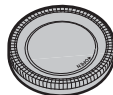

Body cap



CD-ROM



Clip attaching tool



Metal strap clips (x2)

- Owner's Manual (*this manual*)
- Shoulder strap
- Protective covers (x2)

- ◆ If you purchased a lens kit, check that a lens is included.

Parts of the Camera

For more information, refer to the page listed to the right of each item.

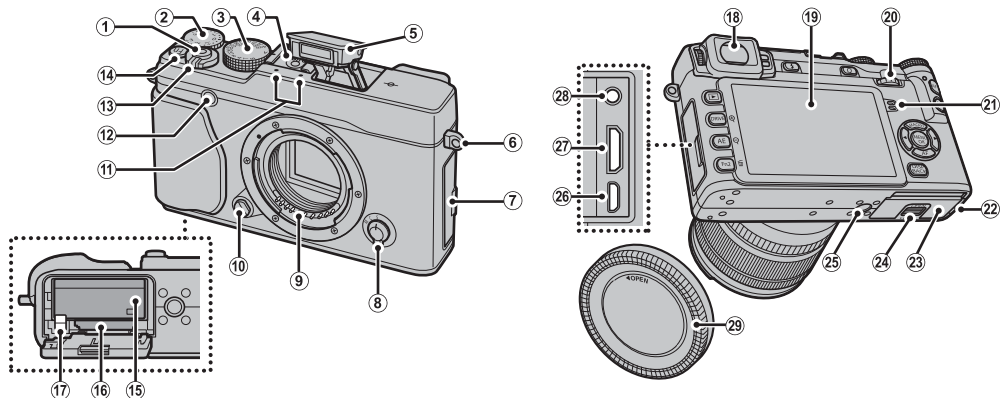

① Shutter button	25	⑫ AF-assist illuminator	77	⑳ Speaker	35
② Exposure compensation dial	53	⑬ Self-timer lamp	55	㉑ Cable channel cover for DC coupler	
③ Shutter speed dial	37, 38, 39, 40	⑭ ON/OFF switch	18	㉒ Battery-chamber cover	14
④ Hot shoe	31, 110	⑮ Fn (function) button	67	㉓ Battery-chamber cover latch	14
⑤ Flash	30	⑯ Wi-Fi button (playback mode)	95	㉔ Tripod mount	
⑥ Strap eyelet	10	⑰ Battery chamber	14	㉕ Micro USB connector	42, 99, 101
⑦ Connector cover	42, 99, 101, 106	⑱ Memory card slot	15	㉖ HDMI mini connector	106
⑧ Focus mode selector	24, 47	㉒ Battery latch	14	㉗ Microphone/remote release connector	34, 42
⑨ Lens signal contacts	7	㉓ Electronic viewfinder (EVF)	20	㉘ Body cap	12
⑩ Lens release button	12	㉔ LCD monitor	20		
⑪ Microphone	33	㉕ Command dial	4		

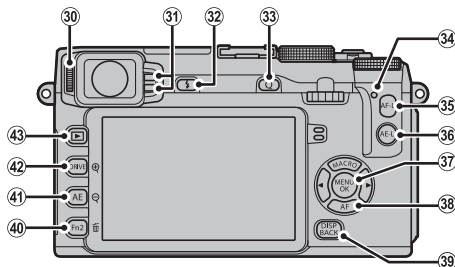

- 30 Diopter adjustment control 21 33 Q (quick menu) button 36
 31 Eye sensor 20 Custom settings button (press and hold)* 36
 32 ⚡ (flash pop-up) button 30 RAW conversion button (playback mode) 66
 * For quick access to custom settings banks (📖 68), press and hold while quick menu for still images (📖 36) is displayed.
- 34 Indicator lamp (see below)
 35 AF-L (focus lock) button 47, 51, 78
 36 AE-L (exposure lock) button 51, 78
 37 MENU/OK button 4
 ⏏ (control lock) button (press and hold) 4
 38 Selector 4
 39 DISP (display)/BACK button 22
 40 Fn2 (function 2) button 67
 🗑 (delete) button 29
 41 AE (autoexposure) button 54
 Function button 67
 🔍 (playback zoom out) button 27, 28
 42 DRIVE button 33, 57, 58, 59, 62, 63
 🔍 (playback zoom in) button 27, 28
 43 ▶ (playback) button 26

🔦 The Indicator Lamp

The indicator lamp shows camera status as follows:

Indicator lamp	Camera status
Glows green	Focus locked.
Blinks green	Blur, focus, or exposure warning. Picture can be taken.
Blinks green and orange	Recording pictures. Additional pictures can be taken.
Glows orange	Recording pictures. No additional pictures can be taken at this time.
Blinks orange	Flash charging; flash will not fire when picture is taken.
Blinks red	Lens or memory error.

- 🔦 Warnings may also appear in the display (📖 118).
- 🔦 The indicator lamp remains off while the viewfinder is in use (📖 20).

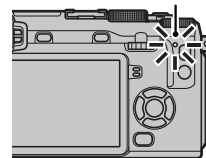

Indicator lamp

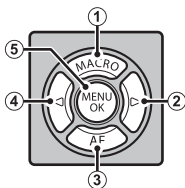

The Selector

Press the selector up (①), right (②), down (③), or left (④) to highlight items and press **MENU/OK** (⑤) to select. Press the selector up (**MACRO**) during shooting to display macro options (📖 32), down (**AF**) to display options for the setting currently assigned to the **AF** button (📖 67; defaults to focus-area selection, 📖 50).

**Control Lock**

To prevent accidental operation of the selector and **AE-L** and **AF-L** buttons during shooting, press **MENU/OK** until  is displayed. The controls can be unlocked by pressing **MENU/OK** until  is no longer displayed.

The Command Dial

The command dial can be used to navigate the menus, to view pictures (📖 26), and to select options in the quick menu display (📖 36).



Press the center of the command dial to zoom in on the active focus area during shooting (📖 48) or playback (📖 27).



Camera Displays

The following types of indicator may be displayed during shooting and playback. In the description that follows, all available indicators are shown for illustrative purposes; the indicators actually displayed vary with camera settings. Note that the LCD monitor and electronic viewfinder have different aspect ratios.

Shooting: Viewfinder/LCD Monitor

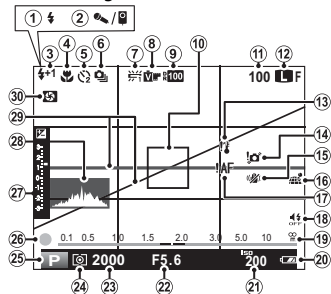

① Flash mode	30	⑰ Focus warning.....	3, 115, 118
② Microphone/remote release.....	34, 42, 80	⑱ Silent mode indicator.....	88
③ Flash compensation	78	⑲ Distance indicator	47
④ Macro (close-up) mode	32	⑳ Battery level.....	18
⑤ Self-timer indicator	55	㉑ Sensitivity	45
⑥ Continuous mode.....	57	㉒ Aperture.....	37, 39, 40
⑦ White balance	43	㉓ Shutter speed.....	37, 38, 40
⑧ Film simulation	64	㉔ Metering.....	54
⑨ Dynamic range.....	75	㉕ Shooting mode	37
⑩ Focus frame.....	51	㉖ Focus indicator	48
⑪ Number of available frames	121	㉗ Exposure compensation/ exposure indicator.....	40, 53
⑫ Image quality and size	74	㉘ Histogram	23
⑬ Temperature warning.....	120	㉙ Virtual horizon	76
⑭ Blur warning	3, 115, 118	㉚ Depth-of-field preview	39
⑮ IS Mode.....	79		
⑯ Location data download status			

■ Shooting: LCD Monitor

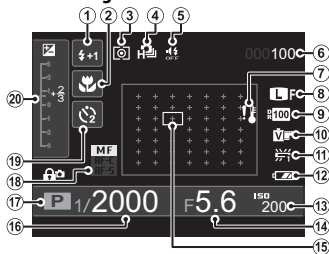

① Flash mode	30	⑪ White balance	43
Flash compensation	78	⑫ Battery level	18
② Macro (close-up) mode	32	⑬ Sensitivity	45
③ Metering	54	⑭ Aperture	37, 39, 40
④ Continuous mode	57	⑮ Focus frame/focus point	50
⑤ Silent mode indicator	88	⑯ Shutter speed	37, 38, 40
⑥ Number of available frames	121	⑰ Shooting mode	37
⑦ Temperature warning	120	⑱ Focus mode	47
⑧ Image quality and size	74	⑲ Self-timer indicator	55
⑨ Dynamic range	75	⑳ Exposure compensation/ exposure indicator	40, 53
⑩ Film simulation	64		

■ Playback: Viewfinder/LCD Monitor

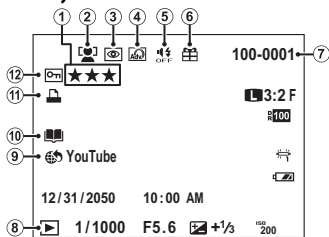

① Rating	26	⑦ Frame number	91
② Intelligent face detection indicator	77	⑧ Playback mode indicator	26
③ Red-eye removal indicator	84	⑨ Mark for upload	85
④ Advanced filter	63	⑩ Photobook assist indicator	72
⑤ Silent mode indicator	88	⑪ DPOF print indicator	103
⑥ Gift image	26	⑫ Protected image	83

Lenses

The camera can be used with lenses for the FUJIFILM X-mount.

Parts of the Lens

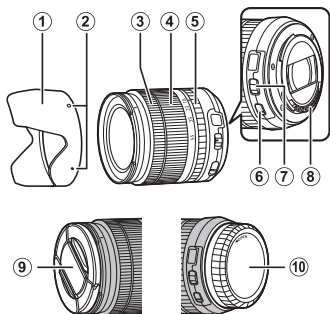

- ① Lens hood
- ② Mounting marks
- ③ Focus ring
- ④ Zoom ring
- ⑤ Aperture ring
- ⑥ O.I.S. switch
- ⑦ Aperture mode switch
- ⑧ Lens signal contacts
- ⑨ Front lens cap
- ⑩ Rear lens cap

Removing the Caps

Remove the caps as shown.

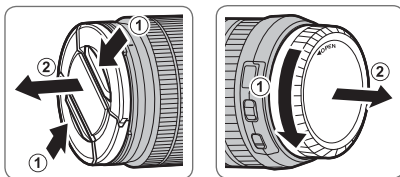

- ① Lens caps may differ from those shown.

Attaching the Hood

When attached, lens hoods reduce glare and protect the front lens element.

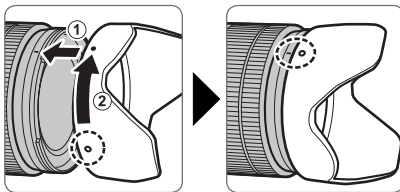



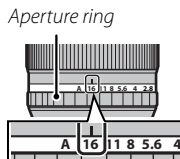

Lenses with Aperture Rings

At settings other than **A**, you can adjust aperture by rotating the lens aperture ring (exposure modes **A** and **M**).

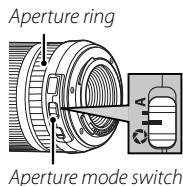
**The Aperture Mode Switch**

If the lens has an aperture mode switch, aperture can be adjusted manually by sliding the switch to  and rotating the aperture ring.

**Lenses with No Aperture Rings**

The method used to adjust aperture can be selected using the  **APERTURE SETTING** option ( 79) in the shooting menu. When an option other than **AUTO** is selected, aperture can be adjusted using the command dial. 

Lenses with O.I.S. Switches

If the lens supports optical image stabilization (O.I.S.), the image stabilization mode can be chosen in the camera menu. To activate image stabilization, slide the O.I.S. switch to **ON**.

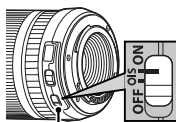

O.I.S. switch

Manual Focus Lenses

Slide the focus ring to the front for autofocus.

For manual focus, slide the focus ring to the back and rotate it while checking the results in the camera display. The focus distance and depth-of-field indicators can be used to assist manual focus. Note that manual focus may not be available in all shooting modes.

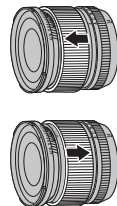

Before You Begin

● The Depth-of-Field Indicator

The depth-of-field indicator shows the approximate depth of field (the distance in front of and behind the focus point that appears to be in focus).

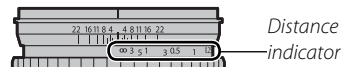

- ❗ The camera does not display the focus distance when the lens is in manual focus mode.

First Steps

Attaching the Strap

Attach the strap clips to the camera and then attach the strap.

1 Open a strap clip.

Use the clip attaching tool to open a strap clip, making sure that the tool and clip are in the orientations shown.



- ① Keep the tool in a safe place. You will need it to open the strap clips when removing the strap.

2 Place the strap clip on an eyelet.

Hook the strap eyelet in the clip opening. Remove the tool, using the other hand to keep the clip in place.

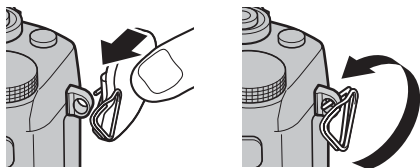

3 Pass the clip through the eyelet.

Rotate the clip fully through the eyelet until it clicks closed.

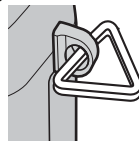

4 Attach a protective cover.

Place a protective cover over the eyelet as shown, with the black side of the cover toward the camera. Repeat Steps 1–4 for the second eyelet.

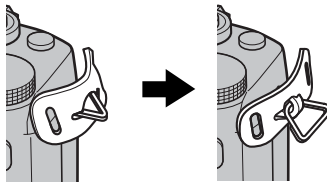

5 Insert the strap.

Insert the strap through a protective cover and strap clip.

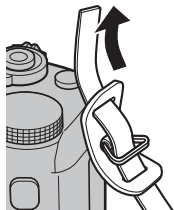
**6 Fasten the strap.**

Fasten the strap as shown. Repeat Steps 5–6 for the second eyelet.

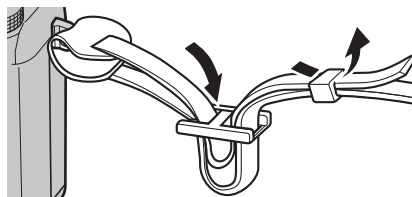

- ⓘ To avoid dropping the camera, be sure the strap is correctly secured.

Attaching a Lens

Lenses attach as described below.

① Care is required to prevent dust entering the camera while attaching and removing lenses.

1 Remove the body and rear caps.

Remove the body cap from the camera and the rear cap from the lens.

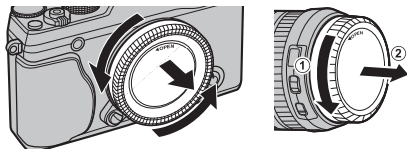

① Do not touch the camera's internal parts.

2 Attach the lens.

Place the lens on mount, keeping the marks on the lens and camera aligned, and then rotate the lens until it clicks into place.

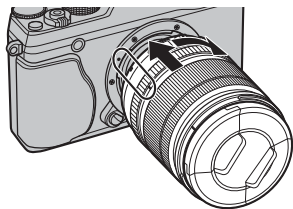

① Do not press the lens release button while attaching the lens.

Removing Lenses

To remove the lens, turn the camera off, then press the lens release button and rotate the lens as shown.

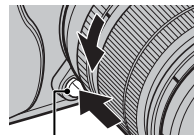

Lens release button

① To prevent dust accumulating on the lens or inside the camera, replace the lens caps and camera body cap when the lens is not attached.

Lenses and Other Optional Accessories

The camera can be used with lenses for the FUJIFILM X-mount and the other accessories listed from page 107.

Charging the Battery

The battery is not charged at shipment. Before use, charge the battery in the supplied battery charger.

1 Place the battery in the charger.

Place the battery in the supplied battery charger as shown.

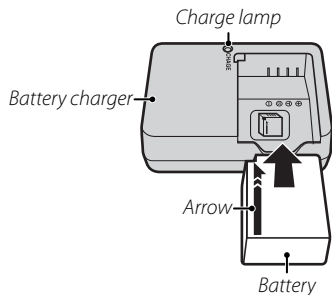

The camera uses an NP-W126 rechargeable battery.

- ❖ The supplied AC cord is for use exclusively with the supplied battery charger. Do not use the supplied charger with other cords or the supplied cord with other devices.

2 Plug the charger in.

Plug the charger into an indoor power outlet. The charging indicator will light.

The Charging Indicator

The charging indicator shows battery charge status as follows:

Charging indicator	Battery status	Action
Off	Battery not inserted.	Insert the battery.
	Battery fully charged.	Remove the battery.
On	Battery charging.	—
Blinks	Battery fault.	Unplug the charger and remove the battery.

3 Charge the battery.

Remove the battery when charging is complete. See the specifications (📖 125) for charging times (note that charging times increase at low temperatures).

- ① Unplug the charger when it is not in use.

Inserting the Battery and a Memory Card

The camera has no internal memory; instead, pictures are stored on optional SD, SDHC, and SDXC memory cards (sold separately). After charging the battery, insert the battery and memory card as described below.

1 Open the battery-chamber cover.

Slide the battery-chamber latch as shown and open the battery-chamber cover.

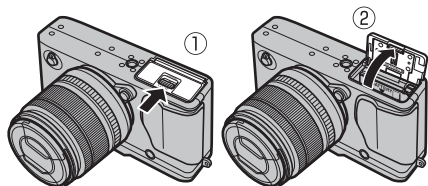

- Ⓛ Do not open the battery-chamber cover when the camera is on. Failure to observe this precaution could damage image files or memory cards.
- Ⓛ Do not use excessive force when handling the battery-chamber cover.

2 Insert the battery.

Using the battery to keep the battery latch pressed to one side, insert the battery contacts first in the direction shown by the arrow. Confirm that the battery is securely latched.

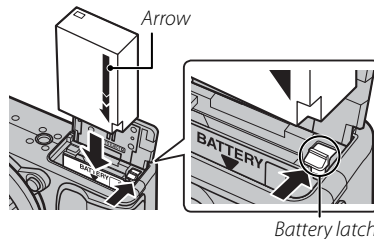

- Ⓛ Insert the battery in the correct orientation. **Do not use force or attempt to insert the battery upside down or backwards.** The battery will slide in easily in the correct orientation.

3 Insert the memory card.

Holding the memory card in the orientation shown at right, slide it in until it clicks into place at the back of the slot.

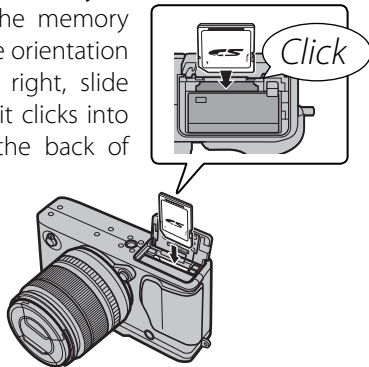

① Be sure card is in the correct orientation; do not insert at an angle or use force.

① SD/SDHC/SDXC memory cards can be locked, making it impossible to format the card or to record or delete images.

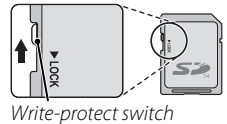

Before inserting a memory card, slide the write-protect switch to the unlocked position.

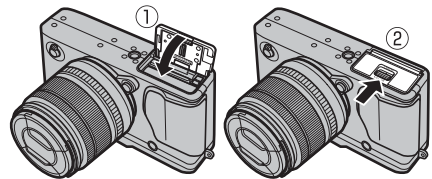
4 Close the battery-chamber cover.

● Removing the Battery and Memory Card

Before removing the battery or memory card, **turn the camera off** and open the battery-chamber cover.

To remove the battery, press the battery latch to the side, and slide the battery out of the camera as shown.

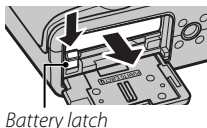

To remove the memory card, press it in and release it slowly. The card can then be removed by hand. When a memory card is removed, the card could be ejected too quickly. Use your finger to hold it and gently release the card.

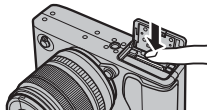

ⓘ Batteries

- Remove dirt from the battery terminals with a clean, dry cloth. Failure to observe this precaution could prevent the battery from charging.
- Do not affix stickers or other objects to the battery. Failure to observe this precaution could make it impossible to remove the battery from the camera.
- Do not short the battery terminals. The battery could overheat.
- Read the cautions in “The Battery and Power Supply” (iv).
- Use only battery chargers designated for use with the battery. Failure to observe this precaution could result in product malfunction.
- Do not remove the labels from the battery or attempt to split or peel the outer casing.
- The battery gradually loses its charge when not in use. Charge the battery one or two days before use.

■ Compatible Memory Cards

FUJIFILM and SanDisk SD, SDHC, and SDXC memory cards have been approved for use in the camera. A complete list of approved memory cards is available at http://www.fujifilm.com/support/digital_cameras/compatibility/. Operation is not guaranteed with other cards. The camera can not be used with **xD-Picture Cards** or **MultiMediaCard** (MMC) devices.



ⓘ Memory Cards

- ***Do not turn the camera off or remove the memory card while the memory card is being formatted or data are being recorded to or deleted from the card.*** Failure to observe this precaution could damage the card.
- Format memory cards before first use, and be sure to reformat all memory cards after using them in a computer or other device. For more information on formatting memory cards, see page 92.
- Memory cards are small and can be swallowed; keep out of reach of children. If a child swallows a memory card, seek medical assistance immediately.
- miniSD or microSD adapters that are larger or smaller than the standard dimensions of an SD/SDHC/SDXC card may not eject normally; if the card does not eject, take the camera to an authorized service representative. Do not forcibly remove the card.
- Do not affix labels to memory cards. Peeling labels can cause camera malfunction.
- Movie recording may be interrupted with some types of SD/SDHC/SDXC memory card. Use a **CLASS10** card or better for movies and burst photography.
- Formatting a memory card in the camera creates a folder in which pictures are stored. Do not rename or delete this folder or use a computer or other device to edit, delete, or rename image files. Always use the camera to delete pictures; before editing or renaming files, copy them to a computer and edit or rename the copies, not the originals. Renaming the files on the camera can cause problems during playback.

Turning the Camera on and Off

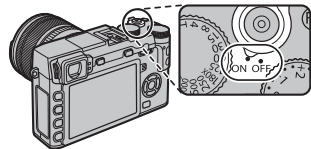



Rotate the **ON/OFF** switch to **ON** to turn the camera on. Select **OFF** to turn the camera off.



- ◆ Press the  button to start playback. Press the shutter button halfway to return to shooting mode.
- ◆ The camera will turn off automatically if no operations are performed for the length of time selected for  **POWER MANAGEMENT > AUTO POWER OFF** (📖 91). To reactivate the camera after it has turned off automatically, press the shutter button halfway or turn the **ON/OFF** switch to **OFF** and then back to **ON**.
- ◆ For information on startup options, see page 91.
- ⚠ Fingerprints and other marks on the lens or viewfinder can affect pictures or the view through the viewfinder. Keep the lens and viewfinder clean.



Battery Level

After turning the camera on, check the battery level in the display.

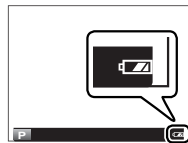
Indicator	Description
 (white)	Battery partially discharged.
 (white)	Battery more than half discharged
 (red)	Low battery. Charge as soon as possible.
 (blinks red)	Battery exhausted. Turn camera off and recharge battery.



Basic Setup

A language-selection dialog is displayed the first time the camera is turned on. Set up the camera as described below (you can reset the clock or change languages at any time using the  **DATE/TIME** or  **言語/LANG.** options in the setup menu; for information on displaying the setup menu, see page 88).

1 Choose a language.



Highlight a language and press **MENU/OK**.

◆ Press **DISP/BACK** to skip the current step. Any steps you skip will be displayed the next time the camera is turned on.



2 Set the date and time.



Press the selector left or right to highlight the year, month, day, hour, or minute and press up or down to change. To change the order in which the year, month, and day are displayed, highlight the date format and press the selector up or down. Press **MENU/OK** to exit to shooting mode when settings are complete.



◆ If the battery is removed for an extended period, the camera clock will be reset and the language-selection dialog will be displayed when the camera is turned on.

Choosing a Display

The camera is equipped with an electronic viewfinder (EVF) and an LCD monitor (LCD). Follow the steps below to choose a display.

1 Display the setup menu.

1.1 Press **MENU/OK** to display the menu for the current mode.



1.2 Press the selector left to highlight the tab for the current menu.



1.3 Press the selector down to highlight the setup menu tab containing **EVF EVF/LCD SETTING**.



1.4 Press the selector right to place the cursor in the setup menu.



2 Select **EVF EVF/LCD SETTING**.





Highlight **EVF EVF/LCD SETTING** and press **MENU/OK**.

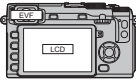

3 Choose a display.

Highlight one of the following options and press **MENU/OK**.

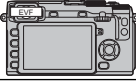

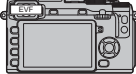
Option	Description
 EYE SENSOR	Automatic display selection using eye sensor 
LCD	LCD monitor only 
EVF	Viewfinder only 
EVF ONLY + 	Viewfinder only; eye sensor turns display on or off 

The Eye Sensor

The eye sensor turns the viewfinder on when you put your eye to the viewfinder and turns it off when you take your eye away (note that the eye sensor may respond to objects other than your eye or to light shining directly on the sensor). If automatic display selection is enabled, the LCD monitor will turn on when the viewfinder turns off.

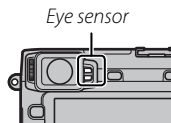

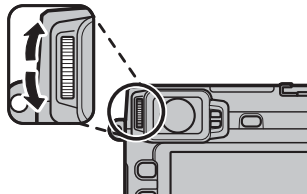

Focusing the Viewfinder

The camera is equipped with diopter adjustment in the range -4 to $+2\text{ m}^{-1}$ to accommodate individual differences in vision. Rotate the diopter adjustment control until the viewfinder display is in sharp focus.



Diopter adjustment control

Adjusting Display Brightness

The brightness of the viewfinder and LCD monitor can be adjusted using the  **SCREEN SET-UP** > **EVF/LCD BRIGHTNESS** option in the setup menu ( 89).

The DISP/BACK Button

The **DISP/BACK** button controls the display of indicators in the viewfinder and LCD monitor.

Viewfinder: Shooting

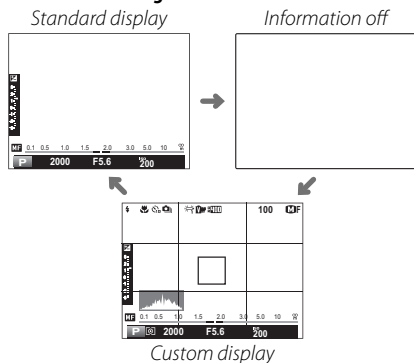

LCD Monitor: Shooting

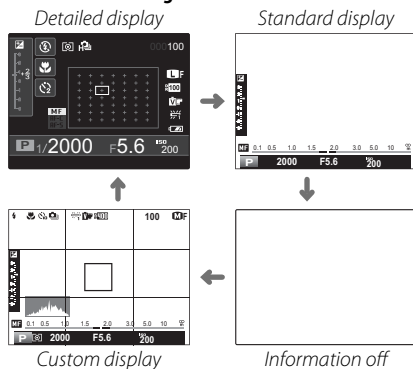

Custom Display

Choose items for display using **DISP. CUSTOM SETTING** in the shooting menu (76):

Framing grid	Exposure (aperture, shutter speed, and sensitivity)	Film simulation
Virtual horizon	Exposure compensation	Dynamic range
Focus distance (autofocus)	Metering	Number of exposures remaining/media
Focus distance (manual focus)	Flash mode	Image quality and size
Histogram	White balance	Battery level

◆ To view the selected items, press **DISP/BACK** to cycle through display modes until CUSTOM indicators are displayed.

◆ See pages 5–6 for the locations of these items in the displays.

Viewfinder/LCD Monitor: Playback

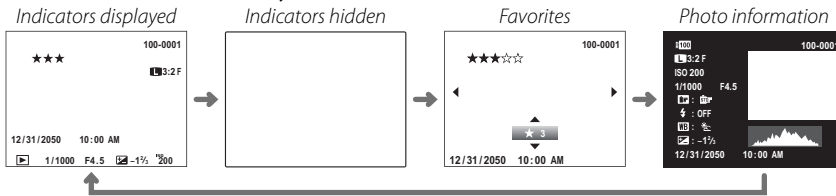

Histograms

Histograms show the distribution of tones in the image. Brightness is shown by the horizontal axis, the number of pixels by the vertical axis.

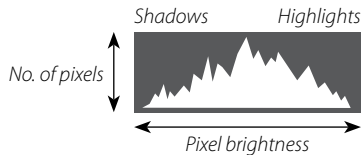

Optimal exposure: Pixels are distributed in an even curve throughout the tone range.



Overexposed: Pixels are clustered on the right side of the graph.



Underexposed: Pixels are clustered on the left side of the graph.



Detailed Information

- | | | |
|--------------------------|--|---------------|
| ① Dynamic range | ② Image size and quality | ③ Sensitivity |
| ④ Shutter speed/aperture | ⑤ Film simulation | ⑥ Flash mode |
| ⑦ White balance | ⑧ Exposure compensation | |
| ⑨ Frame number | ⑩ Picture (overexposed areas blink on and off) | |
| ⑪ Histogram | | |

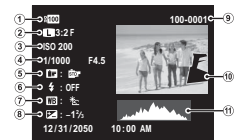

Basic Photography and Playback

Taking Photographs

This section describes how to take pictures using program AE (mode **P**). For information on **S**, **A**, and **M** modes, see page 37.

1 Select program AE.

Set shutter speed and aperture to **A**. **P** will appear in the display.

Image stabilization (📖 9) is recommended.

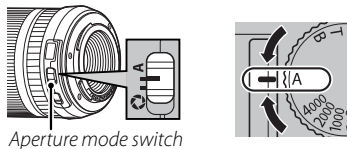

Aperture mode switch

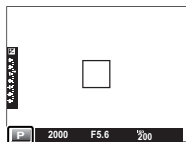

The Q Button

The **Q** button can be used to view and adjust camera settings (📖 36).

2 Select single AF.

Rotate the focus mode selector to **S** (📖 47).

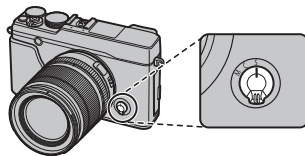

3 Ready the camera.

Hold the camera steady with both hands and brace your elbows against your sides. Shaking or unsteady hands can blur your shots.



To prevent pictures that are out of focus or too dark (underexposed), keep your fingers and other objects away from the lens, flash, and AF-assist illuminator.



4 Frame the picture.

Lenses with Zoom Rings

Use the zoom ring to frame the picture in the display.

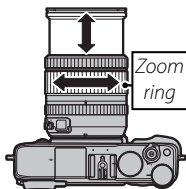

5 Focus.

Frame the picture with your subject in the center of the display and press the shutter button halfway to focus.



- ◆ If the subject is poorly lit, the AF-assist illuminator may light ( 77).

If the camera is able to focus, it will beep twice and focus area and focus indicator will glow green. Focus and exposure will lock while the shutter button is pressed halfway.

If the camera is unable to focus, the focus frame will turn red, **!AF** will be displayed, and the focus indicator will blink white. If the subject is close to the camera (the actual distance varies with the lens; for more information, see the lens manual), select macro mode and try again ( 32).

6 Shoot.

Smoothly press the shutter button the rest of the way down to take the picture.



Viewing Pictures

Viewing Pictures Full Frame

Pictures can be viewed in the viewfinder or LCD monitor. When taking important pictures, take a test shot and check the results.

To view pictures full frame, press .

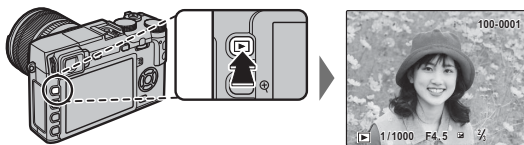

Additional pictures can be viewed by pressing the selector left or right or rotating the command dial. Press the selector or rotate the dial right to view pictures in the order recorded, left to view pictures in reverse order. Keep the selector pressed to scroll rapidly to the desired frame.



◆ Pictures taken using other cameras are indicated by a  ("gift image") icon during playback.

Favorites: Rating Pictures

To rate the current picture, press **DISP/BACK** and press the selector up and down to select from zero to five stars.

Viewing Photo Information

The photo information display changes each time the selector is pressed up.

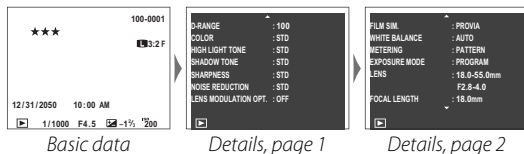

Basic data

Details, page 1

Details, page 2

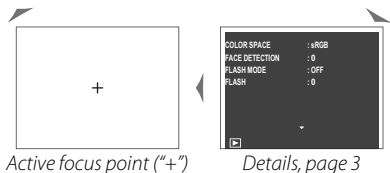

Active focus point (“+”)

Details, page 3

- Rotate the command dial to view other images.

Zooming in on the Focus Point

Press the center of the command dial to zoom in on the focus point. Press the center of the command dial again to return to full-frame playback.

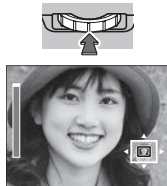

Playback Zoom

Press to zoom in on the current picture, to zoom out (to view multiple images, press when the picture is displayed full frame; [28](#)). When the picture is zoomed in, the selector can be used to view areas of the image not currently visible in the display. Press **DISP/BACK** or **MENU/OK** to exit zoom.

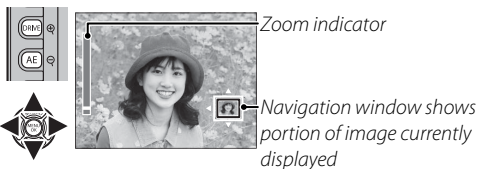

Zoom indicator



Navigation window shows portion of image currently displayed

- The maximum zoom ratio varies with image size ([74](#)). Playback zoom is not available with cropped or resized copies saved at a size of [640](#).

Multi-Frame Playback

To change the number of images displayed, press  when a picture is displayed full frame.





Use the selector to highlight images and press **MENU/OK** to view the highlighted image full frame (to zoom in on the selected image, press  when the picture is displayed full frame;  27). In the nine- and hundred-frame displays, press the selector up or down to view more pictures.

Deleting Pictures

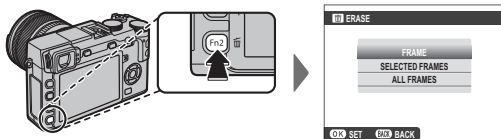
To delete individual pictures, multiple selected pictures, or all pictures, press the  button when a picture is displayed full frame and choose from the options below. **Note that deleted pictures can not be recovered.** *Copy important pictures to a computer or other storage device before proceeding.*



Option	Description
FRAME	Press the selector left or right to scroll through pictures and press MENU/OK to delete the current picture (a confirmation dialog is not displayed).
SELECTED FRAMES	Highlight pictures and press MENU/OK to select or deselect (pictures in photobooks or print orders are shown by ). When the operation is complete, press DISP/BACK to display a confirmation dialog, then highlight OK and press MENU/OK to delete the selected pictures.
ALL FRAMES	A confirmation dialog will be displayed; highlight OK and press MENU/OK to delete all unprotected pictures. Pressing DISP/BACK cancels deletion; note that any pictures deleted before the button was pressed can not be recovered.

- ❖ Protected pictures can not be deleted. Remove protection from any pictures you wish to delete ( 83).
- ❖ Pictures can also be deleted by  **ERASE** from playback menu.
- ❖ If a message appears stating that the selected images are part of a DPOF print order, press **MENU/OK** to delete the pictures.

Using the Flash







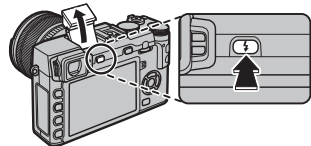

Use the built-in flash for additional lighting when shooting at night or indoors under low light.

1 Press the  button to raise the flash.





- ① The flash may contact accessories mounted on the hot shoe. If necessary, remove accessories before raising the flash.



2 Select  **FLASH MODE** in the shooting menu. The options shown below will be displayed; press the selector up or down to highlight an option and press **MENU/OK** to select.

Mode	Description
 AUTO (AUTO FLASH)/  (RED EYE REDUCTION)*	The flash fires when required. Recommended in most situations.
 (FORCED FLASH)/  (FORCED FLASH)*	The flash fires whenever a picture is taken. Use for backlit subjects or for natural coloration when shooting in bright light.
 (SLOW SYNCHRO)/  (RED EYE & SLOW)*	Capture both the main subject and the background under low light (note that brightly lit scenes may be overexposed).
 (2ND CURTAIN SYNC./  (2ND CURTAIN SYNC.)*	The flash fires immediately before the shutter closes.
 (COMMANDER)	The built-in flash can be used to control optional remote flash units.



* When Intelligent Face Detection is active (📖 77) and **ON** is selected for  **RED EYE REMOVAL** in the setup menu (📖 79), red-eye removal is available in , , , and . Red-eye removal minimizes “red-eye” caused when light from the flash is reflected from the subject’s retinas as shown in the illustration at right.



- ① Depending on the distance to the subject, some lenses may cast shadows in photos taken with the flash.
- 🔍 Lower the flash where flash photography is prohibited or to capture natural lighting under dim light. We also recommend that you lower the flash when the camera is off.
- 🔍 If  is displayed when the shutter button is pressed halfway, the flash will fire when the photo is taken.
- 🔍 Except in commander mode, the flash may fire several times with each shot. Do not move the camera until shooting is complete.

Flash Sync Speed

The flash will synchronize with the shutter at shutter speeds of $\frac{1}{180}$ s or slower.

Optional Flash Units

The camera can also be used with optional FUJIFILM shoe-mounted flash units. Do not use third-party flash units that apply over 300V to the camera hot shoe.

Macro Mode (Close-ups)

To focus at short distances, press the selector up (**MACRO**) and select . To exit macro mode, press the selector up and select **OFF**.

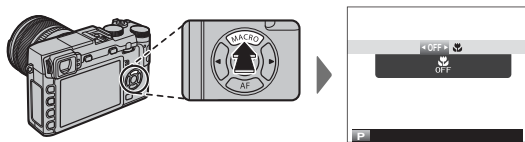

◆ The distances at which the camera will focus in macro mode vary with the lens. See the lens manual for details.

Basic Movie Recording and Playback

Recording High-Definition (HD) Movies

The camera can be used to record short high-definition movies. Sound is recorded in stereo via the built-in microphone; do not cover the microphone during recording.

1 Set aperture to **A**.

- ◆ Image stabilization (📖 9) is recommended.

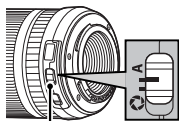

Aperture mode switch

2 Press the **DRIVE** button to display drive options. Press the selector up or down to highlight **MOVIE** and press **MENU/OK**.

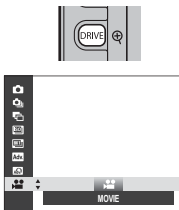

3 Press the shutter button all the way down to start recording.



4 Press the shutter button all the way down again to end recording. Recording ends automatically when the maximum length is reached or the memory card is full.



- ◆ Frame size and rate can be selected using the **MOVIE MODE** option (📖 80). Focus mode is selected using the focus mode selector (📖 47); for continuous focus adjustment, select **C**, or choose **S** and enable Intelligent Face Detection (📖 77, 80). Intelligent Face Detection is not available in focus mode **M**.

- ◆ During recording, exposure compensation can be adjusted by up to ± 2 EV.

- ◆ The indicator lamp lights while movies are being recorded.

- ⓘ The microphone may pick up lens noise and other sounds made by the camera during recording.

- ⓘ Vertical or horizontal streaks may appear in movies containing very bright subjects. This is normal and does not indicate a malfunction.

The Q Button

The **Q** button can be used to view and adjust camera settings (📖 36).

Depth of Field

Adjust aperture before recording begins. Choose low f-numbers to soften background details. The effect can be heightened by increasing the distance between your subject and the background.

- ① Movies recorded when the aperture is displayed in red will not be correctly exposed.

Using an External Microphone

Sound can be recorded with external microphones. See the microphone manual for details; if the microphone jack is 3.5 mm in diameter, use a 3.5-to-2.5 mm adapter.

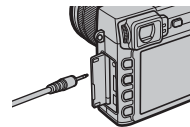

- ✎ The dialog shown at right will be displayed when a microphone is connected to the microphone/remote release connector. Press **MENU/OK** and select **MIC/REMOTE RELEASE > MIC** (80).

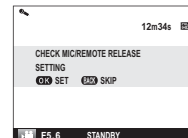

Viewing Movies

During playback, movies are displayed as shown at right. The following operations can be performed while a movie is displayed:

Operation	Description
Start/pause playback	Press the selector down to start playback. Press again to pause. While playback is paused, you can press the selector left or right to rewind or advance one frame at a time.
End playback	Press the selector up to end playback.
Adjust speed	Press the selector left or right to adjust playback speed during playback.
Adjust volume	Press MENU/OK to pause playback and display volume controls. Press the selector up or down to adjust the volume; press MENU/OK again to resume playback. Volume can also be adjusted using the SOUND SET-UP > PLAYBACK VOLUME option in the playback menu (89).

Movie icon

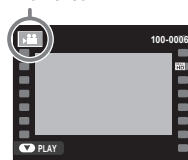

Progress is shown in the display during playback.

- ⓘ Do not cover the speaker during playback.
- ⓘ Sound is not played back in silent mode.

Progress bar

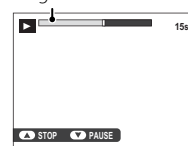

Playback Speed

Press the selector left or right to adjust playback speed during playback. Speed is shown by the number of arrows (▶ or ◀).

Arrow

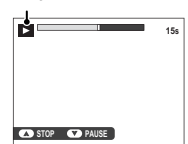

The Q (Quick Menu) Button

Press **Q** for quick access to the following items. For more information on the options available, see the pages listed below.

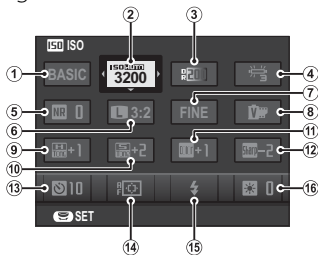

1	SELECT CUSTOM SETTING.....	68	9	HIGHLIGHT TONE	75
2	ISO	45	10	SHADOW TONE	75
3	DYNAMIC RANGE	75	11	COLOR	75
4	WB WHITE BALANCE	43	12	SHARPNESS	75
5	NR NOISE REDUCTION	76	13	SELF-TIMER	55
6	IMAGE SIZE.....	74	14	AF MODE	77
7	IMAGE QUALITY	74	15	FLASH MODE	30
8	FILM SIMULATION	64	16	EVF/LCD BRIGHTNESS.....	89

1 Press **Q** to display the quick menu during shooting.

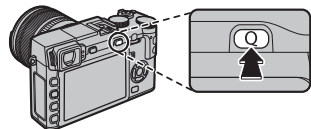

2 Use the selector to highlight items and rotate the command dial to change.



3 Press **Q** to exit when settings are complete.

Movie Mode

In movie mode, the quick menu contains the following items:

WB WHITE BALANCE	43	FILM SIMULATION.....	64
MOVIE MODE	80	EVF/LCD BRIGHTNESS.....	89

More on Photography and Playback

Choosing an Exposure Mode

The camera offers a choice of program AE (**P**), shutter-priority AE (**S**), aperture-priority AE (**A**), and manual exposure (**M**) modes.

Program AE (P)

To allow the camera to adjust both shutter speed and aperture for optimal exposure, set shutter speed and aperture to **A**. **P** will appear in the display.

- ① If the subject is outside the metering range of the camera, the shutter speed and aperture displays will show “---”.

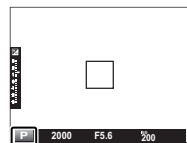
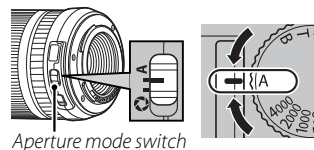

Program Shift

If desired, you can press the selector left or right to other combinations of shutter speed and aperture without altering exposure (program shift). The new values for shutter speed and aperture are shown in yellow. Program shift is not available if the attached flash supports TTL auto, **AUTO** is selected for **D-Ring DYNAMIC RANGE** in the shooting menu (75), or an auto option is selected for **ISO ISO** in the shooting menu (45). To cancel program shift, turn the camera off.

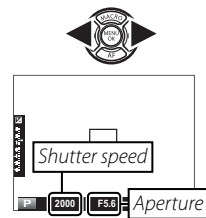

Shutter-Priority AE (S)

To adjust shutter speed manually while letting the camera select aperture for optimal exposure, set aperture to **A** and use the shutter speed dial. **S** will appear in the display.

- ◆ At settings other than **180X**, shutter speed can also be adjusted in increments of $\frac{1}{3}$ EV by rotating the command dial or (except in advanced filter mode; 63) by pressing the selector left or right. Shutter speed can be adjusted even while the shutter button is pressed halfway.
- ① If the correct exposure can not be achieved at the selected shutter speed, aperture will be displayed in red when the shutter button is pressed halfway. Adjust shutter speed until the correct exposure is achieved.
- ① If the subject is outside the metering range of the camera, the aperture display will show “---”.

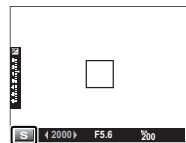
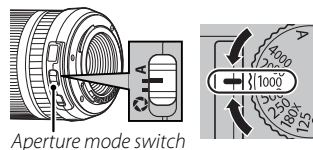

Lenses with No Aperture Ring

If the lens is not equipped with an aperture ring, shutter speed can only be adjusted by pressing the selector left or right. Shutter speed can not be adjusted in advanced filter mode (63).

Aperture-Priority AE (A)

To adjust aperture manually while letting the camera select shutter speed for optimal exposure, rotate the shutter speed dial to **A** and adjust aperture as desired. **A** will appear in the display.

- ◆ Aperture can be adjusted even while the shutter button is pressed halfway.
- ① If the correct exposure can not be achieved at the selected aperture, the shutter speed will be displayed in red when the shutter button is pressed halfway. Adjust aperture until the correct exposure is achieved.
- ① If the subject is outside the metering range of the camera, the shutter speed display will show "----".

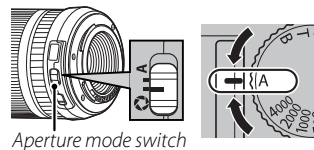

Aperture mode switch

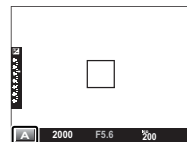
**Previewing Depth of Field**

When **PREVIEW DEPTH OF FIELD** is assigned to any of the **Fn**, **Fn2**, **AE**, and **AF** buttons using the **FUNCTION (Fn) SETTING** option (67) in the shooting menu, pressing the button stops aperture down to the selected setting, allowing depth of field to be previewed in the viewfinder or LCD monitor.

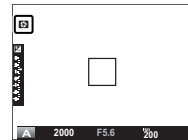

Manual Exposure (M)

Exposure can be altered from the value suggested by the camera by setting both shutter speed and aperture to values other than **A**. **M** will appear in the display.

- At settings other than **180X**, shutter speed can also be adjusted in increments of $\frac{1}{3}$ EV by rotating the command dial or (except in advanced filter mode; 63) by pressing the selector left or right.

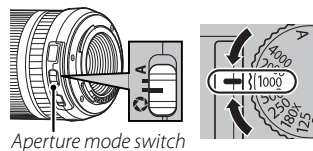

Aperture mode switch

- The manual exposure display includes an exposure indicator that shows the amount the picture would be under- or over-exposed at current settings.

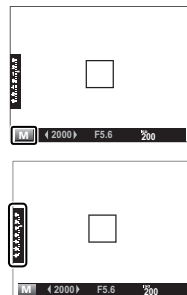

Exposure Preview

To preview exposure in the LCD monitor, select **ON** for **SCREEN SET-UP > PREVIEW EXP. IN MANUAL MODE**. Select **OFF** when using the flash or on other occasions on which exposure may change when the picture is taken.



Lenses with No Aperture Ring

If the lens is not equipped with an aperture ring, shutter speed can only be adjusted by pressing the selector left or right. Shutter speed can not be adjusted in advanced filter mode (63).

Long Time-Exposures (T/B)

Select a shutter speed of **T** (time) or **B** (bulb) for long time-exposures.

- Use of a tripod is recommended to prevent the camera from moving during the exposure.
- To reduce “noise” (mottling) in long time-exposures, select **ON** for **LONG EXPOSURE NR** in the shooting menu (📖 76). Note that this may increase the time needed to record images after shooting.

Time (T)

1 Rotate the shutter speed dial to **T**.



2 Press the selector left or right to choose a shutter speed between 30 s and 1/2 s in steps of 1/3 EV.

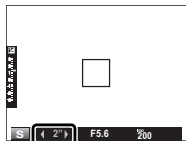

3 Press the shutter button all the way down to take a picture at the selected shutter speed. A count-down timer will be displayed while the exposure is in progress.



Bulb (B)

1 Rotate the shutter speed dial to **B**.



2 Press the shutter button all the way down. The shutter will remain open for up to 60 minutes while the shutter button is pressed; the display shows the time elapsed since the exposure started.



- Selecting an aperture of **A** fixes shutter speed at 30 s.

Using a Remote Release

An optional RR-90 remote release can be used for long time-exposures. See the manual provided with the RR-90 for more information.

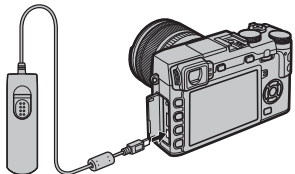

● Third-Party Remote Releases

Third-party remote releases (available from third-party suppliers) can be connected as shown below.

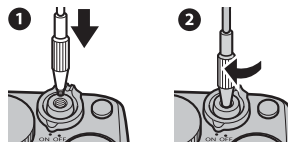



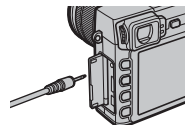





Alternatively, electronic remote releases can be connected via the microphone/remoterelease connector.





White Balance

For natural colors, select **WB WHITE BALANCE** in the shooting menu to display the following options, then use the selector to highlight an option that matches the light source and press **MENU/OK**. The dialog shown at bottom right will be displayed; use the selector to fine-tune white balance or press **DISP/BACK** to exit without fine-tuning.

Option	Description
AUTO	White balance adjusted automatically.
	Measure a value for white balance (🗨 44).
K	Selecting this option displays a list of color temperatures (🗨 44); highlight a temperature and press MENU/OK to select the highlighted option and display the fine-tuning dialog.
	For subjects in direct sunlight.

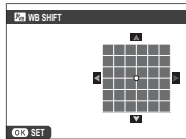
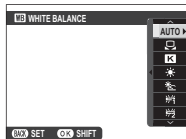

Option	Description
	For subjects in the shade.
	Use under “daylight” fluorescent lights.
	Use under “warm white” fluorescent lights.
	Use under “cool white” fluorescent lights.
	Use under incandescent lighting.
	Reduces the blue cast typically associated with underwater lighting.



- ❖ White balance is adjusted for flash lighting only in **AUTO** and  modes. Turn the flash off using other white balance options.
- ❖ Results vary with shooting conditions. Play pictures back after shooting to check colors.
- ❖ White balance can also be assigned to any of the **Fn**, **Fn2**, **AE**, and **AF** buttons using the **Fn FUNCTION (Fn) SETTING** option (🗨 67) in the shooting menu.

Custom White Balance

Choose  to adjust white balance for unusual lighting conditions. White balance measurement options will be displayed; frame a white object so that it fills the display and press the shutter button all the way down to measure white balance (to select the most recent custom value and exit without measuring white balance, press **DISP/BACK**, or press **MENU/OK** to select the most recent value and display the fine-tuning dialog).

- If **"COMPLETED!"** is displayed, press **MENU/OK** to set white balance to the measured value.
- If **"UNDER"** is displayed, raise exposure compensation ( 53) and try again.
- If **"OVER"** is displayed, lower exposure compensation ( 53) and try again.

Color Temperature

Color temperature is an objective measure of the color of a light source, expressed in Kelvin (K). Light sources with a color temperature close to that of direct sunlight appear white; light sources with a lower color temperature have a yellow or red cast, while those with a higher color temperature are tinged with blue. You can match color temperature to the light source as shown in the following table, or choose options that differ sharply from the color of the light source to make pictures "warmer" or "colder."

◀ Choose for redder light sources
or "colder" pictures

Choose for bluer light sources ▶
or "warmer" pictures

2,000 K

Candlelight

Sunset/sunrise

5,000 K

Direct sunlight

15,000 K

Blue sky

Shade

Sensitivity

“Sensitivity” refers to the camera’s sensitivity to light. Choose from values between 200 and 6400, or select **L (100)**, **H (12800)**, or **H (25600)** for special situations. Higher values can be used to reduce blur when lighting is poor, while lower values allow slower shutter speeds or wider apertures in bright light; note, however, that mottling may appear in pictures taken at high sensitivities, particularly at **H (25600)**, while choosing **L (100)** reduces dynamic range. Values of from ISO 200 to ISO 6400 are recommended in most situations. If **AUTO** is selected, the camera will adjust sensitivity automatically in response to shooting conditions.

1 Press **MENU/OK** in shooting mode to display the shooting menu. Press the selector up or down to highlight **ISO ISO** and press **MENU/OK**.

- ◆ Sensitivity can also be assigned to any of the **Fn**, **Fn2**, **AE**, and **AF** buttons using the **Fn FUNCTION (Fn) SETTING** option (📖 67) in the shooting menu.



2 Press the selector up or down to highlight the desired option and press **MENU/OK** to select.

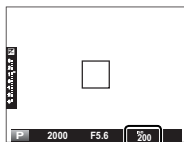

- ◆ Sensitivity is not reset when the camera is turned off.
- ◆ **L (100)** is reset to ISO 200 and **H (12800)** and **H (25600)** are reset to ISO 6400 when **RAW**, **FINE+RAW**, or **NORMAL+RAW** is selected for image quality (📖 74). For more information on the settings available with **L (100)**, **H (12800)**, and **H (25600)**, see page 127.

■ AUTO

The following options are available when **AUTO** is selected:

Option	Default
DEFAULT SENSITIVITY	200
MAX. SENSITIVITY	800
MIN. SHUTTER SPEED	1/60

The camera automatically chooses a sensitivity between the default and maximum values. Sensitivity is only raised above the default value if the shutter speed required for optimal exposure would be slower than the value selected for **MIN. SHUTTER SPEED**.

- ◆ If the value selected for **DEFAULT SENSITIVITY** is higher than that selected for **MAX. SENSITIVITY**, **DEFAULT SENSITIVITY** will be set to the value selected for **MAX. SENSITIVITY**.
- ◆ The camera may select shutter speeds slower than **MIN. SHUTTER SPEED** if pictures would still be underexposed at the value selected for **MAX. SENSITIVITY**.

Focus Mode

Use the focus mode selector to choose how the camera focuses (note that regardless of the option selected, manual focus will be used when the lens is in manual focus mode).

- **S** (single AF): Focus locks while the shutter button is pressed halfway. Choose for stationary subjects.
- **C** (continuous AF): Focus is continually adjusted to reflect changes in the distance to the subject while the shutter button is pressed halfway. Use for subjects that are in motion.
- **M** (manual): Focus manually using the lens focus ring. Rotate the ring left to reduce the focus distance, right to increase. The manual focus indicator indicates how closely the focus distance matches the distance to the subject in the focus brackets (the white line indicates the focus distance, the blue bar the depth of field, or in other words the distance in front of and behind the focus point that appears to be in focus); you can also check focus visually in the viewfinder or LCD monitor. Choose for manual control of focus or in situations in which the camera is unable to focus using autofocus (📖 52).

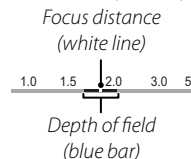
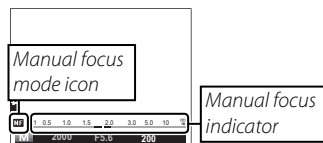
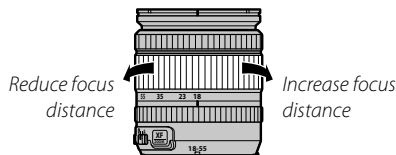
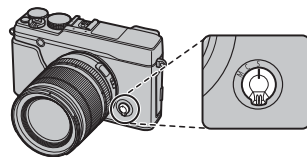

- ❖ Use the **FOCUS RING** option in the setup menu (📖 90) to reverse the direction of rotation of the focus ring.
- ❖ To use autofocus to focus on the subject in the selected focus area (📖 50), press the **AF-L** button. Use this feature to quickly focus on a chosen subject in manual focus mode.
- ❖ The camera can show focus distance in meters or feet. Use the **SCREEN SET-UP > FOCUS SCALE UNITS** option in the setup menu (📖 90) to choose the units used.
- ❖ If **ON** is selected for **P-AF PRE-AF** in the shooting menu (📖 78), focus will be adjusted continuously in modes **S** and **C** even when the shutter button is not pressed.

■ The Focus Indicator

The focus indicator turns green when the subject is in focus and blinks white when the camera is unable to focus. Brackets (“()”) indicate that the camera is focusing and are displayed continuously in mode **C** while the shutter button is pressed halfway. **MF** is displayed in manual focus mode.

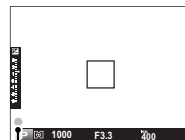

Focus indicator

● Checking Focus

To zoom in on the current focus area (📖 50) for precise focus, press the center of the command dial. Press the dial again to cancel zoom. In manual focus mode, zoom can be adjusted by rotating the command dial when **STANDARD** or **FOCUS PEAK HIGHLIGHT** is selected for **MF MF ASSIST**, while if **ON** is selected for **SCREEN SET-UP > MF FOCUS CHECK**, the camera will automatically zoom in on the selected focus area when the focus ring is rotated. Focus zoom is not available in focus mode **C** or when **P-AF PRE-AF** is on.

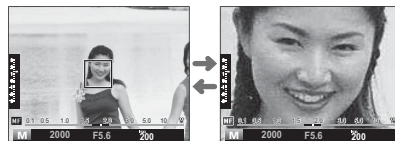

MF Assist

The **MF ASSIST** option in the setup menu can be used to check focus when pictures are framed in the LCD monitor or electronic viewfinder in manual focus mode.

The **MF ASSIST** menu can be displayed by pressing and holding the center of the command dial.

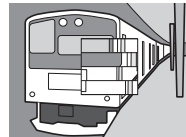

The following options are available:

- **FOCUS PEAK HIGHLIGHT:** Highlights high-contrast outlines. Rotate the focus ring until the subject is highlighted.
- **DIGITAL SPLIT IMAGE:** Displays a split, black-and-white image in the center of the frame. Frame the subject in the split-image area and rotate the focus ring until the three parts of the split image are correctly aligned.





Focus Frame Selection

The camera offers a choice of focus points, allowing photographs to be composed with the main subject positioned almost anywhere in the frame.

- ⓘ In focus modes **S** and **C**, focus-area selection is only available when  **AREA** is selected for  **AF MODE** in the shooting menu and Intelligent Face Detection ( 77) is off.

To position the focus frame, press the selector down (**AF**) and then press the selector up, down, left, or right (the focus frame can be returned to the center by pressing **DISP/BACK**). Press **MENU/OK** to put the setting into effect. In manual focus mode, you can also select the focus point using the **AF** button.

In focus modes **S** and **C**, you can choose the size of the focus frame by pressing the selector down (**AF**) and rotating the command dial. Rotate the dial left to reduce the frame by up to 50%, right to enlarge it by up to 150%, or press the center of the dial to restore the frame to its original size. Press **MENU/OK** to put the setting into effect.

- ◆ At default settings, focus-area selection is assigned to the **AF** button and can be accessed by pressing the selector down, but it can also be assigned to any of the **Fn**, **Fn2**, and **AE** buttons ( 67). Focus-area selection can also be accessed using the  **FOCUS AREA** option in the shooting menu.

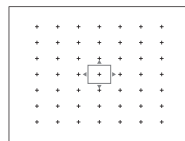
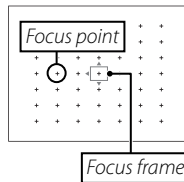
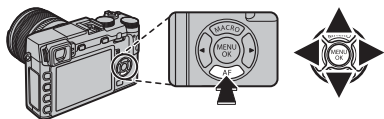

Focus/Exposure Lock

To compose photographs with off-center subjects:

1 Focus: Position the subject in the focus frame and press the shutter button halfway to lock focus and exposure. Focus and exposure will remain locked while the shutter button is pressed halfway (AF/AE lock).



- ◆ Focus and exposure can also be locked with the **AF-L** and **AE-L** buttons, respectively (if **AE/AF LOCK** is selected for **AF-L AF-LOCK BUTTON** in the shooting menu, pressing the **AF-L** button will lock both focus and exposure; [78](#)).

2 Recompose: Keep the shutter button pressed halfway or keep the **AF-L** or **AE-L** button pressed.

- ◆ Focus and/or exposure will remain locked while the **AF-L** or **AE-L** button is pressed, whether or not the shutter button is pressed halfway. If **AE&AF ON/OFF SWITCH** is selected for **AE/AF-LOCK MODE** ([78](#)), focus and/or exposure lock when the button is pressed and remain locked until the button is pressed again.



3 Shoot: Press the button all the way down.



Autofocus

Although the camera boasts a high-precision autofocus system, it may be unable to focus on the subjects listed below.

- Very shiny subjects such as mirrors or car bodies.



- Fast-moving subjects.

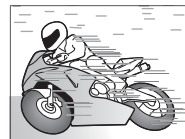

- Subjects photographed through a window or other reflective object.
- Dark subjects and subjects that absorb rather than reflect light, such as hair or fur.
- Insubstantial subjects, such as smoke or flame.
- Subjects that show little contrast with the background (for example, subjects in clothing that is the same color as the background).
- Subjects positioned in front of or behind a high-contrast object that is also in the focus frame (for example, a subject photographed against a backdrop of highly contrasting elements).

Exposure Compensation

Rotate the exposure compensation dial to adjust exposure when photographing very bright, very dark, or high-contrast subjects. The effect is visible in the display.



Exposure compensation indicator

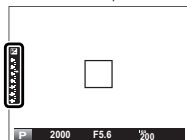

Standard display

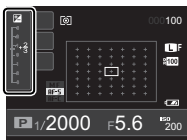

Detailed display (LCD monitor)

Choose positive values (+) to increase exposure



Choose negative values (-) to reduce exposure



① The amount of compensation available varies with the shooting mode.

Exposure Value (EV)

The exposure value is determined by the sensitivity of the image sensor and the amount of light to which the sensor is exposed. Doubling the amount increases EV by one, while halving it reduces EV by one. The amount of light entering the camera can be controlled by adjusting aperture and shutter speed.

Choosing an Exposure Compensation Value

- **Backlit subjects:** Choose values from $+2/3$ EV to $+1 2/3$ EV.



- **Highly reflective subjects or very bright scenes** (e.g., snowfields): $+1$ EV



- **Scenes that are mostly sky:** $+1$ EV



- **Spotlit subjects** (particularly if photographed against dark backgrounds): $-2/3$ EV

- **Subjects with low reflectivity** (pine trees or dark-colored foliage): $-2/3$ EV

Metering

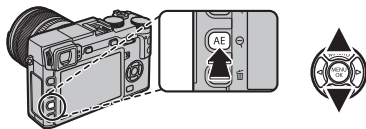
To choose how the camera meters exposure, press the **AE** button to display metering options. Use the selector to highlight an option and press **AE** to select.



Mode	Description
 (MULTI)	The camera instantly determines exposure based on an analysis of composition, color, and brightness distribution. Recommended in most situations.
 (SPOT)	The camera meters lighting conditions in an area at the center of the frame equivalent to 2% of the total. Recommended with backlit subjects and in other cases in which the background is much brighter or darker than the main subject.
 (AVERAGE)	Exposure is set to the average for the entire frame. Provides consistent exposure across multiple shots with the same lighting, and is particularly effective for landscapes and portraits of subjects dressed in black or white.

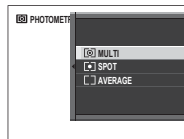

◆ At default settings, metering selection is assigned to the **AE** button, but it also can be assigned to any of the **Fn**, **Fn2**, and **AF** buttons (📖 67) or accessed using the  **PHOTOMETRY** option in the shooting menu.

ⓘ The selected option will only take effect when Intelligent Face Detection is off (📖 77).



Using the Self-Timer

Use the timer for self-portraits or to prevent blur caused by camera shake.

- 1 Press **MENU/OK** in shooting mode to display the shooting menu. Press the selector up or down to highlight  **SELF-TIMER** and press **MENU/OK**.



- 2 Press the selector up or down to highlight one of the following options and press **MENU/OK** to select.

Option	Description
 2 SEC	The shutter is released two seconds after the shutter button is pressed. Use to reduce blur caused by the camera moving when the shutter button is pressed.
 10 SEC	The shutter is released ten seconds after the shutter button is pressed. Use for photographs in which you wish to appear yourself.
OFF	Self-timer off.

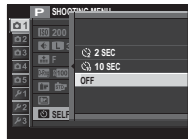

- 3 Press the shutter button halfway to focus.

- 1 Stand behind the camera when using the shutter button. Standing in front of the lens can interfere with focus and exposure.



- 4** Press the shutter button the rest of the way down to start the timer. The display in the monitor shows the number of seconds remaining until the shutter is released. To stop the timer before the picture is taken, press **DISP/BACK**.

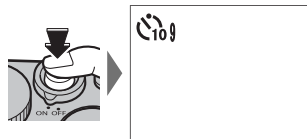

The self-timer lamp on the front of the camera will blink immediately before the picture is taken. If the two-second timer is selected, the self-timer lamp will blink as the timer counts down.

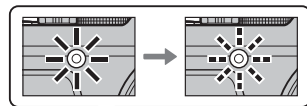

- ◆ The self-timer turns off automatically when the camera is turned off.

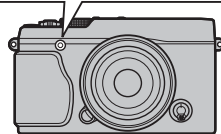



Continuous Shooting (Burst Mode)

Capture motion in a series of pictures.

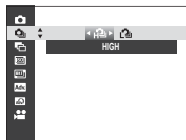
- 1 Press the **DRIVE** button to display drive options.



- 2 Press the selector up or down to highlight , then press the selector left or right to choose a frame rate of  (high) or  (low). Press **MENU/OK** to proceed when settings are complete.



- 3 Press the shutter button halfway to focus.



- 4 Press the shutter button the rest of the way down to start shooting. Shooting ends when the shutter button is released, the maximum number of pictures has been taken, or the memory card is full.



- ◆ Focus and exposure are determined by the first frame in each series. The flash turns off automatically; the previously-selected flash mode is restored when burst shooting is turned off. To allow focus and exposure to vary automatically from frame to frame, select  and rotate the focus-mode selector to **C**.
- ◆ Frame rate varies with the subject, shutter speed, and focus mode and may slow as more shots are taken.
- ◆ Additional time may be required to record pictures when shooting ends.
- ◆ If file numbering reaches 999 before shooting is complete, the remaining pictures will be recorded to a new folder (📁 91).
- ◆ In some drive modes, shooting may not begin if the space available on the memory card is insufficient.

Bracketing

Automatically vary settings over a series of pictures.

- 1 Press the **DRIVE** button to display drive options and press the selector up or down to highlight one of the following:



Option	Description
AE BKT	Press the selector left or right to highlight a bracketing amount. Each time the shutter button is pressed, the camera will take three shots at up to about 6fps: one using the metered value for exposure, the second overexposed by the selected amount, and the third underexposed by the same amount (regardless of the amount selected, exposure will not exceed the limits of the exposure metering system).
ISO BKT	Press the selector left or right to highlight a bracketing amount. Each time the shutter is released, the camera will take a picture at the current sensitivity (45) and process it to create two additional copies, one with sensitivity raised and the other with sensitivity lowered by the selected amount (regardless of the amount selected, sensitivity will not exceed ISO 6400 or fall below ISO 200).
FILM SIMULATION BKT	Each time the shutter is released, the camera takes one shot and processes it to create copies with the film simulation settings selected for FILM SIMULATION BKT in the shooting menu (75).
DYNAMIC RANGE BKT	Each time the shutter button is pressed, the camera takes three shots with different dynamic ranges (75): 100% for the first, 200% for the second, and 400% for the third. The shots are taken at rates of up to about 6fps. While dynamic range bracketing is in effect, sensitivity will be restricted to a minimum of ISO 800; the sensitivity previously in effect is restored when bracketing ends.



Press **MENU/OK** to select the highlighted option.

- 2 Take photographs.

Panoramas

Follow an on-screen guide to create a panorama.

- 1 Press the **DRIVE** button to display drive options. Press the selector up or down to highlight **Adv.**, then press the selector left or right to highlight **MOTION PANORAMA** and press **MENU/OK**.

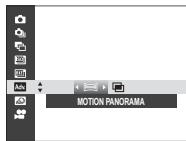

- 2 To select the size of the angle through which you will pan the camera while shooting, press the selector left. Highlight a size and press **MENU/OK**.



- 3 Press the selector right to view a choice of pan directions. Highlight a pan direction and press **MENU/OK**.



- 4 Press the shutter button all the way down to start recording. There is no need to keep the shutter button pressed during recording.

- 5 Pan the camera in the direction shown by the arrow. Shooting ends automatically when the camera is panned to the end of the guides and the panorama is complete.

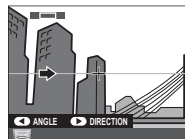



- ◆ Shooting ends if the shutter button is pressed all the way down during shooting. No panorama may be recorded if the shutter button is pressed before the panorama is complete.

- ① Panoramas are created from multiple frames; exposure for the entire panorama is determined by the first frame. The camera may in some cases record a greater or lesser angle than selected or be unable to stitch the frames together perfectly. The last part of the panorama may not be recorded if shooting ends before the panorama is complete.
- ① Shooting may be interrupted if the camera is panned too quickly or too slowly. Panning the camera in a direction other than that shown cancels shooting.
- ① The desired results may not be achieved with moving subjects, subjects close to the camera, unvarying subjects such as the sky or a field of grass, subjects that are in constant motion, such as waves and waterfalls, or subjects that undergo marked changes in brightness. Panoramas may be blurred if the subject is poorly lit.

For Best Results

For best results, use a lens with a focal length of 35 mm or less (50 mm or less in 35 mm format). Prop your elbows against your sides and move the camera slowly in a small circle at a steady speed, keeping the camera parallel or at right angles to the horizon and being careful only to pan in the direction shown by the guides. Use a tripod for best results. If the desired results are not achieved, try panning at a different speed.

Viewing Panoramas

To zoom in on a panorama in full-frame playback, press the  button and use the  and  buttons to zoom in and out. Alternatively, you can play the panorama back using the selector. Press the selector down to start playback and press again to pause. While playback is paused, you can scroll the panorama manually by pressing the selector left or right; vertical panoramas will scroll vertically, horizontal panoramas horizontally. To exit to full-frame playback, press the selector up.

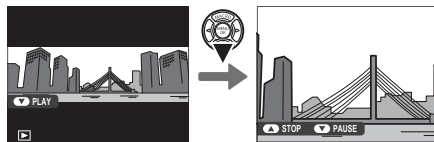

Multiple Exposures

Create a photograph that combines two exposures.



- 1 Press the **DRIVE** button to display drive options. Press the selector up or down to highlight **Adv**, then press the selector left or right to highlight **MULTIPLE EXPOSURE** and press **MENU/OK**.

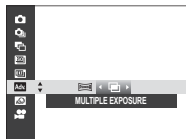

- 2 Take the first shot.

- 3 Press **MENU/OK**. The first shot will be shown superimposed on the view through the lens and you will be prompted to take the second shot.



- ◆ To return to Step 2 and retake the first shot, press the selector left. To save the first shot and exit without creating a multiple exposure, press **DISP/BACK**.

- 4 Take the second shot, using the first frame as a guide.

- 5 Press **MENU/OK** to create the multiple exposure, or press the selector left to return to Step 4 and retake the second shot.



Advanced Filter



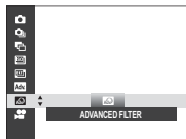

Take photos with filter effects.









- 1 Press the **DRIVE** button to display drive options. Press the selector up or down to highlight **ADV** and press **MENU/OK**.



- 2 Choose from the following filters and press **MENU/OK**.



Filter	Description
 TOY CAMERA	Choose for a retro toy camera effect.
 MINIATURE	The tops and bottoms of pictures are blurred for a diorama effect.
 POP COLOR	Create high-contrast images with saturated colors.
 HIGH-KEY	Create bright, low-contrast images.
 LOW-KEY	Create uniformly dark tones with few areas of emphasized highlights.

Filter	Description
 DYNAMIC TONE	Dynamic tone expression is used for a fantasy effect.
 SOFT FOCUS	Create a look that is evenly soft throughout the whole image.
 PARTIAL COLOR (RED)	Areas of the image that are the selected color are recorded in that color. All other areas of the image are recorded in black-and-white.
 PARTIAL COLOR (ORANGE)	
 PARTIAL COLOR (YELLOW)	
 PARTIAL COLOR (GREEN)	
 PARTIAL COLOR (BLUE)	
 PARTIAL COLOR (PURPLE)	

- ◆ Depending on the subject and camera settings, images may in some cases be grainy or vary in brightness and hue.
- ◆ Filter effects can also be selected by pressing the selector left when the camera is in shooting mode.











Film Simulation

Simulate the effects of different kinds of film, including black-and-white (with or without color filters).

- 1 Press **MENU/OK** in shooting mode to display the shooting menu. Press the selector up or down to highlight  **FILM SIMULATION** and press **MENU/OK**.



- 2 Press the selector up or down to highlight one of the following options and press **MENU/OK** to select.

Option	Description
 (PROVIA/STANDARD)	Standard color reproduction. Suited to a wide range of subjects, from portraits to landscapes.
 (Velvia/VIVID)	A high-contrast palette of saturated colors, suited to nature photos.
 (ASTIA/SOFT)	Enhances the range of hues available for skin tones in portraits while preserving the bright blues of daylight skies. Recommended for outdoor portrait photography.
 (PRO Neg. Hi)	Offers slightly more contrast than  (PRO Neg. Std). Recommended for outdoor portrait photography.
 (PRO Neg. Std)	A soft-toned palette. The range of hues available for skin tones is enhanced, making this a good choice for studio portrait photography.
 (MONOCHROME)	Take pictures in standard black and white.
 (MONOCHROME + Ye FILTER)	Take black-and-white pictures with slightly increased contrast. This setting also slightly tones down the brightness of the sky.
 (MONOCHROME + R FILTER)	Take black-and-white pictures with increased contrast. This setting also tones down the brightness of the sky.
 (MONOCHROME + G FILTER)	Soften skin tones in black-and-white portraits.
 (SEPIA)	Take pictures in sepia.

-  Film simulation options can be combined with tone and sharpness settings (📖 75).

Recording Pictures in RAW Format

To record raw, unprocessed data from the camera image sensor, select a **RAW** option for image quality in the shooting menu as described below. JPEG copies of RAW images can be created using the **RAW RAW CONVERSION** option in the playback menu, or RAW images can be viewed on a computer using the RAW FILE CONVERTER application that is installed with the software on the supplied CD (📖 97, 98).

- 1 Press **MENU/OK** in shooting mode to display the shooting menu. Press the selector up or down to highlight **IMAGE QUALITY** and press **MENU/OK**.
- 2 Highlight an option and press **MENU/OK**. Select **RAW** to record only RAW images, or **FINE+RAW** or **NORMAL+RAW** to record both JPEG copy together with the RAW images. **FINE+RAW** uses lower JPEG compression ratios for higher-quality JPEG images, while **NORMAL+RAW** uses higher JPEG compression ratios to increase the number of images that can be stored.

The Function Button

To toggle RAW image quality on or off for a single shot, assign **RAW** to any of the **Fn**, **Fn2**, **AE**, or **AF** buttons (📖 67). If a JPEG option is currently selected for image quality, pressing the button temporarily selects the equivalent JPEG+RAW option. If a JPEG+RAW option is currently selected, pressing the button temporarily selects the equivalent JPEG option, while if **RAW** is selected, pressing the button temporarily selects **FINE**. Taking a picture or pressing the button again restores the previous setting.

🔍 Sensitivities of **L (100)**, **H (12800)**, and **H (25600)** are not available when RAW image quality is on (📖 45).

Creating JPEG Copies of RAW Pictures

RAW pictures store information on camera settings separately from the data captured by the camera image sensor. Using the **RAW RAW CONVERSION** option in the playback menu, you can create JPEG copies of RAW pictures using different options for the settings listed below. The original image data are unaffected, allowing a single RAW image to be processed in a multitude of different ways.

- 1 Press **MENU/OK** during playback to display the playback menu, then press the selector up or down to highlight **RAW RAW CONVERSION** and press **MENU/OK** to display the settings listed in the table at right.

◆ These options can also be displayed by pressing **Q** button during playback.

- 2 Press the selector up or down to highlight a setting and press the selector right to select. Press the selector up or down to highlight the desired option and press **MENU/OK** to select and return to the settings list. Repeat this step to adjust additional settings.

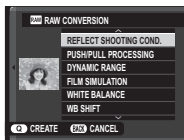

- 3 Press the **Q** button to preview the JPEG copy and press **MENU/OK** to save.

Setting	Description
REFLECT SHOOTING COND.	Create a JPEG copy using the settings in effect at the time the photo was taken.
PUSH/PULL PROCESSING	Adjust exposure by -1 EV to $+3$ EV in increments of $\frac{1}{2}$ EV (📖 53).
DYNAMIC RANGE	Enhance details in highlights for natural contrast (📖 75).
FILM SIMULATION	Simulate the effects of different types of film (📖 64).
WHITE BALANCE	Adjust white balance (📖 43).
WB SHIFT	Fine-tune white balance (📖 43).
COLOR	Adjust color density (📖 75).
SHARPNESS	Sharpen or soften outlines (📖 75).
HIGHLIGHT TONE	Adjust highlights (📖 75).
SHADOW TONE	Adjust shadows (📖 75).
NOISE REDUCTION	Process the copy to reduce mottling (📖 76).
LENS MODULATION OPTIMIZER	Improve definition by adjusting for diffraction and the slight loss of focus at the periphery of the lens (📖 76).
COLOR SPACE	Choose the color space used for color reproduction (📖 92).

Function Buttons

The roles played by the **Fn**, **Fn2**, **AE**, and **AF** buttons can be selected using the **Fn** **FUNCTION (Fn) SETTING** option in the shooting menu (📖 90).

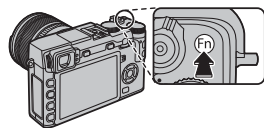

Fn button

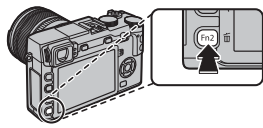

Fn2 button

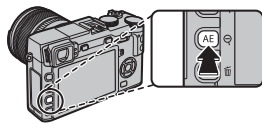

AE button

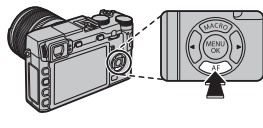

AF button

The options available include advanced filters (📖 63), multiple exposure (📖 62), depth-of-field preview (📖 39), sensitivity (📖 45), the self-timer (📖 55), image size (📖 74), image quality (📖 74), dynamic range (📖 75), film simulation (📖 64), white balance (📖 43), metering (📖 54), AF mode (📖 77), focus-area selection (📖 50), custom settings (📖 68), movie recording (📖 33), RAW/JPEG toggle (📖 65), and aperture setting (📖 79) and wireless (📖 95) options.

◆ You can also display options for any of the **Fn**, **Fn2**, **AE**, and **AF** buttons by pressing and holding the button.

Saving Settings

Save up to 7 sets of custom camera settings for commonly-encountered situations. Saved settings can be recalled using the **SELECT CUSTOM SETTING** option in the shooting menu.

- 1 Press **MENU/OK** in shooting mode to display the shooting menu. Press the selector up or down to highlight **EDIT/SAVE CUSTOM SETTING** and press **MENU/OK**.



- 2 Highlight a custom settings bank and press **MENU/OK** to select. Adjust the following as desired and press **DISP/BACK** when adjustments are complete: **ISO** ISO, **D-Rng** DYNAMIC RANGE, **Film** FILM SIMULATION, **WB** WHITE BALANCE, **Color** COLOR, **Sharp** SHARPNESS, **HIGHLIGHT TONE**, **SHADOW TONE**, and **NR** NOISE REDUCTION.

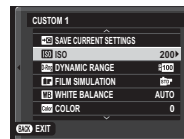

- ◆ To replace the settings in the selected bank with the settings currently selected with the camera, select **SAVE CURRENT SETTINGS** and press **MENU/OK**.

- 3 A confirmation dialog will be displayed; highlight **OK** and press **MENU/OK**.

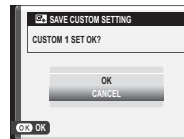

Using a Mount Adapter

When M-mount lenses are attached using an optional **FUJIFILM M MOUNT ADAPTER**, the camera processes pictures as they are taken to maintain image quality and correct for a variety of effects.

- Attaching a mount adapter enables **LENS SHOOT WITHOUT LENS** (📖 77) and hides the distance indicator in the standard display.
- Before checking focus, set the focus mode selector to **M** (📖 47).

Mount Adapter Settings

Pressing the function button on the mount adapter displays **LENS MOUNT ADAPTOR SETTING** options.

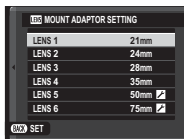

Choosing a Focal Length

If the lens has a focal length of 21, 24, 28, or 35 mm, choose a matching option in the **LENS MOUNT ADAPTOR SETTING** menu. For other lenses, select option 5 or 6 and use the selector to enter the focal length.

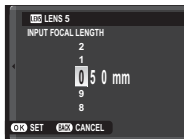

Distortion Correction

Choose from **STRONG, MEDIUM, or WEAK** options to correct **BARREL** or **PINCUSHION** distortion.

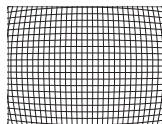
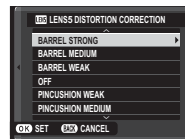

Barrel distortion

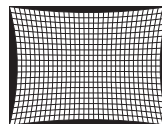

Pincushion distortion

- To determine the amount required, adjust distortion correction while taking photos of graph paper or other objects featuring repeating vertical and horizontal lines, such as the windows in a high-rise.

■ Color Shading Correction

Color (shading) variations between the center and edges of the frame can be adjusted separately for each corner.

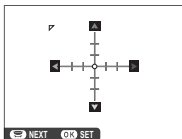

To use color shading correction, follow the steps below.

- 1 Rotate the command dial to choose a corner. The selected corner is indicated by a triangle.



- 2 Use the selector to adjust shading until there is no visible difference in color between the selected corner and the center of the image. Press the selector left or right to adjust colors on the cyan-red axis, up or down to adjust colors on the blue-yellow axis. There are a total of 19 positions available on each axis.



- ◆ To determine the amount required, adjust color shading correction while taking photos of blue sky or a sheet of gray paper.

■ Peripheral Illumination Correction

Choose from values between -5 and +5. Choosing positive values increases peripheral illumination, while choosing negative values reduces peripheral illumination. Positive values are recommended for vintage lenses, negative values to create the effect of images taken with an antique lens or a pinhole camera.

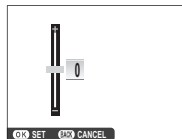

- ◆ To determine the amount required, adjust peripheral illumination correction while taking photos of blue sky or a sheet of gray paper.



Image Search

Follow the steps below to search for pictures.

- 1 Press **MENU/OK** during playback to display the playback menu. Press the selector up or down to highlight  **IMAGE SEARCH** and press **MENU/OK**.
- 2 Highlight an option and press **MENU/OK**.

Option	Description
BY DATE	Search by date.
BY FACE	Search for pictures that include faces.
BY ★ FAVORITES	Search by rating (📖 26).
BY TYPE OF DATA	Find all still pictures, all movies, or all RAW pictures.
BY UPLOAD MARK	Find all pictures selected for upload to a specified destination.



- 3 Select a search condition. Only pictures that match the search condition will be displayed. To delete or protect selected pictures or to view the selected pictures in a slide show, press **MENU/OK** and choose from the options at right.
- 4 To end the search, select **EXIT SEARCH**.



Option	See page
 ERASE	81
 PROTECT	83
 SLIDE SHOW	84

PhotoBook Assist

Create books from your favorite photos.

Creating a PhotoBook

1 Select **NEW BOOK** for  **PHOTOBOOK ASSIST** in the playback menu ( 85) and choose from the following options:

- **SELECT FROM ALL:** Choose from all available pictures.
- **SELECT BY IMAGE SEARCH:** Choose from pictures matching selected search conditions ( 71).
- ◆ Neither photographs  640 or smaller nor movies can be selected for photobooks.

2 Scroll through the images and press the selector up to select or deselect. To display the current image on the cover, press the selector down. Press **MENU/OK** to exit when the book is complete.

- ◆ The first picture selected becomes the cover image. Press the selector down to select a different image for the cover.

3 Highlight **COMPLETE PHOTOBOOK** and press **MENU/OK** (to select all photos or all photos matching the specified search conditions for the book, choose **SELECT ALL**). The new book will be added to the list in the photo-book assist menu.

- ⓘ Books can contain up to 300 pictures.
- ⓘ Books that contain no photos are automatically deleted.

Viewing Photobooks

Highlight a book in the photobook assist menu and press **MENU/OK** to display the book, then press the selector left or right to scroll through the pictures.

Editing and Deleting Photobooks

Display the photobook and press **MENU/OK**. The following options will be displayed; select the desired option and follow the on-screen instructions.

- **EDIT:** Edit the book as described in “Creating a PhotoBook” (📖 72).
- **ERASE:** Delete the book.

Photobooks

Photobooks can be copied to a computer using the supplied MyFinePix Studio software (📖 96).

Menus

Using the Menus: Shooting Mode

The shooting menu is used to adjust settings for a wide range of shooting conditions. To display the shooting menu, press **MENU/OK** in shooting mode. Highlight items and press the selector right to view options, then highlight an option and press **MENU/OK**. Press **DISP/BACK** to exit when settings are complete.

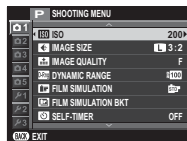

Shooting Menu Options (Photographs)

ISO ISO

Control the camera's sensitivity to light (📖 45).

IMAGE SIZE

Choose the size and aspect ratio at which still pictures are recorded.

Aspect Ratio

Pictures with an aspect ratio of 3:2 have the same proportions as a frame of 35 mm film, while an aspect ratio of 16:9 is suited to display on High Definition (HD) devices. Pictures with an aspect ratio of 1:1 are square.

IMAGE SIZE is not reset when the camera is turned off or another shooting mode is selected.

Option	Prints at sizes up to	Option	Prints at sizes up to
L 3:2	41 × 28 cm (16 × 11 in.)	S 3:2	21 × 14 cm (8 × 5 in.)
L 16:9	41 × 23 cm (16 × 9 in.)	S 16:9	21 × 12 cm (8 × 4 in.)
L 1:1	28 × 28 cm (11 × 11 in.)	S 1:1	14 × 14 cm (5 × 5 in.)
M 3:2	29 × 20 cm (11 × 7 in.)		
M 16:9	29 × 16 cm (11 × 6 in.)		
M 1:1	20 × 20 cm (7 × 7 in.)		

IMAGE QUALITY

Choose a file format and compression ratio. Select **FINE** or **NORMAL** to record JPEG images, **RAW** to record RAW images, or **FINE+RAW** or **NORMAL+RAW** to record both JPEG and RAW images. **FINE** and **FINE+RAW** use lower JPEG compression ratios for higher-quality JPEG images, while **NORMAL** and **NORMAL+RAW** use higher JPEG compression ratios to increase the number of images that can be stored.

D-Rng DYNAMIC RANGE

Control contrast. Choose lower values to increase contrast when shooting indoors or under overcast skies, higher values to reduce loss of detail in highlights and shadows when photographing high-contrast scenes. Higher values are recommended for scenes that include both sunlight and deep shade, for such high-contrast subjects as sunlight on water, brightly-lit autumn leaves, and portraits taken against a blue sky, and for white objects or people wearing white; note, however, that mottling may appear in pictures taken at higher values.

- ◆ If **AUTO** is selected, shutter speed and aperture will be displayed when the shutter button is pressed halfway.
- ◆ **#200 200%** is available at sensitivities of ISO 400 and above, **#400 400%** at sensitivities of ISO 800 and above.

F FILM SIMULATION

Simulate the effects of different types of film (📖 64).

F FILM SIMULATION BKT

Choose film types for film simulation bracketing (📖 58).

⏱ SELF-TIMER

Take pictures with the self-timer (📖 55).

WB WHITE BALANCE

Adjust colors to match the light source (📖 43).

Color COLOR

Adjust color density.

Sharp SHARPNESS

Sharpen or soften outlines.

HL HIGHLIGHT TONE

Adjust the appearance of highlights.

SH SHADOW TONE

Adjust the appearance of shadows.

NR NOISE REDUCTION

Reduce noise in pictures taken at high sensitivities.

LE LONG EXPOSURE NR

Select **ON** to reduce mottling in long time-exposures (📖 41).

LMO LENS MODULATION OPTIMIZER

Select **ON** to improve definition by adjusting for diffraction and the slight loss of focus at the periphery of the lens.

CS SELECT CUSTOM SETTING

Recall settings saved with **CS** EDIT/SAVE CUSTOM SETTING.

CS EDIT/SAVE CUSTOM SETTING

Save settings (📖 68).

DISP DISP. CUSTOM SETTING

Choose the items displayed in the viewfinder and LCD monitor (📖 22). The following items can be displayed: framing grid (you can also select the grid type as described on page 90), virtual horizon, focus distance (auto or manual), histogram, exposure (shutter speed, aperture, and sensitivity), exposure compensation/exposure indicator, metering, flash mode, white balance, film simulation, dynamic range, number of exposures remaining, image size and quality, and battery level. See pages 5–6 for the locations of these items in the displays. Press the selector up or down to highlight items and press **MENU/OK** to select or deselect. Press **DISP/BACK** to exit when settings are complete, then select the custom display as described on page 22.

Virtual Horizon

Selecting **ELECTRONIC LEVEL** displays a virtual horizon. The camera is level when the two lines overlap.

❖ The virtual horizon may not be displayed if the camera lens is pointed up or down.

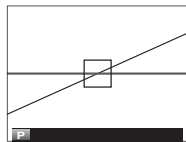

MOUNT ADAPTOR SETTING

Adjust settings for M-mount lenses connected using an optional **FUJIFILM M MOUNT ADAPTER** (📖 69).

SHOOT WITHOUT LENS

Choose whether shutter release is enabled when no lens is attached.

AF ILLUMINATOR

If **ON** is selected, the AF-assist illuminator will light to assist autofocus.

- ◆ The AF-assist illuminator turns off automatically in silent mode.
- ⓘ The camera may be unable to focus using the AF-assist illuminator in some cases. If the camera is unable to focus in macro mode, try increasing the distance to the subject.
- ⓘ Avoid shining the AF-assist illuminator directly into your subject's eyes.

AF MODE

Choose how the camera selects the focus area in focus modes **S** and **C**.

- **MULTI**: When the shutter button is pressed halfway, the camera detects high-contrast subjects and selects the focus area automatically.
- **AREA**: Choose the focus area manually (📖 50).

FACE DETECTION

Intelligent Face Detection sets focus and exposure for human faces anywhere in the frame, preventing the camera from focusing on the background in group portraits. Choose for shots that emphasize portrait subjects.

To use Intelligent Face Detection, press **MENU/OK** to display the shooting menu and select **ON** for **FACE DETECTION**. Faces can be detected with the camera in vertical or horizontal orientation; if a face is detected, it will be indicated by a green border. If there is more than one face in the frame, the camera will select the face closest to the center; other faces are indicated by white borders.

- ⓘ In some modes, the camera may set exposure for the frame as a whole rather than the portrait subject.
- ⓘ If the subject moves as the shutter button is pressed, their face may not be in the area indicated by the green border when the picture is taken.



FOCUS AREA

Choose the focus area ( 50).

PRE-AF

If **ON** is selected, the camera will continue to adjust focus even when the shutter-release button is not pressed halfway. Note that this increases the drain on the battery.

PHOTOMETRY

Choose how the camera meters exposure ( 54).

AE/AF-LOCK MODE

If **AE & AF ON WHEN PRESSING** is selected, exposure and/or focus will lock while the **AE-L** or **AF-L** button is pressed. If **AE & AF ON/OFF SWITCH** is selected, exposure and/or focus will lock when the **AE-L** or **AF-L** button is pressed and remain locked until the button is pressed again.

AF-LOCK BUTTON

Choose the role played by the **AF-L** button ( 51).

WIRELESS COMMUNICATION

Connect via a wireless network to upload pictures to smartphones or tablets, remotely browse the pictures on the camera and select images for download, or copy location data to the camera ( 95).

♦ For more information, visit <http://app.fujifilm-dsc.com>.

FLASH MODE

Choose a flash mode ( 30).

FLASH COMPENSATION

Adjust flash brightness. Choose from values between +2EV and -2EV. Note that the desired results may not be achieved depending on shooting conditions and the distance to the subject.



 **RED EYE REMOVAL**

Choose **ON** to remove red-eye effects caused by the flash.

- ◆ Red-eye reduction is performed only when a face is detected.
- ◆ Red-eye removal is not available with RAW images.

 **IS MODE**

Reduce blur. This option is available only with lenses that support image stabilization.

-  **CONTINUOUS:** Image stabilization on.
-  **SHOOTING ONLY:** Image stabilization enabled only when the shutter button is pressed halfway or the shutter is released.
- **OFF:** Image stabilization off;  appears in the display (p. 5). Recommended when using a tripod.

 **APERTURE SETTING**

Choose the method used to adjust aperture when using lenses with no aperture rings.

- **AUTO +**  **MANUAL:** Rotate the command dial to choose the aperture. Rotate past minimum aperture to choose **A** (auto).
 - **AUTO:** Aperture is selected automatically; camera functions in exposure mode **P** (program AE) or **S** (shutter-priority AE).
 - **MANUAL:** Rotate the command dial to choose the aperture; camera functions in exposure mode **A** (aperture-priority AE) or **M** (manual).
- ◆ Aperture can not be adjusted while the view through the camera lens is zoomed in.

 **MF ASSIST**

Choose how focus is displayed in manual focus mode (p. 49).

- **STANDARD:** Focus is displayed normally (focus peaking and digital split image are not available).
- **DIGITAL SPLIT IMAGE:** A black-and-white split-image display.
- **FOCUS PEAK HIGHLIGHT:** The camera heightens high-contrast outlines. Choose from **LOW** and **HIGH**.

Shooting Menu Options (Movie Mode)

The following options are available in movie mode (📖 33).

MOVIE MODE

Select a frame size for movie recording.

- **1920×1080 60 fps:** Full HD (60 fps)
- **1920×1080 30 fps:** Full HD (30 fps)
- **1280×720 60 fps:** HD (60 fps)
- **1280×720 30 fps:** HD (30 fps)

FACE DETECTION

Intelligent Face Detection sets focus and exposure for human faces anywhere in the frame, preventing the camera from focusing on the background in group portraits (📖 77).

FILM SIMULATION

Simulate the effects of different types of film (📖 64).

WHITE BALANCE

Adjust colors to match the light source (📖 43).

MIC LEVEL ADJUSTMENT

Adjust the microphone recording level.

MIC/REMOTE RELEASE

Specify whether the device connected to the microphone/remote release connector is a microphone or a remote release (📖 34, 42).

DISP. CUSTOM SETTING

Choose the items displayed in the viewfinder and LCD monitor (📖 76).

IS MODE

Reduce blur. This option is available only with lenses that support image stabilization.

APERTURE SETTING

Choose the method used to adjust aperture when using lenses with no aperture rings (📖 79).

Using the Menus: Playback Mode

To display the playback menu, press **MENU/OK** in playback mode. Highlight items and press the selector right to view options, then highlight an option and press **MENU/OK**. Press **DISP/BACK** to exit when settings are complete.

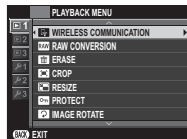

Playback Menu Options

WIRELESS COMMUNICATION

Connect via a wireless network to upload pictures to smartphones or tablets, remotely browse the pictures on the camera and select images for download, or copy location data to the camera (📖 95).

💡 For more information, visit <http://app.fujifilm-dsc.com>.

RAW CONVERSION

Create JPEG copies of RAW pictures (📖 66).



ERASE

Delete all or selected pictures.

- **FRAME:** Press the selector left or right to scroll through pictures and press **MENU/OK** to delete the current picture (a confirmation dialog is not displayed).
- **SELECTED FRAMES:** Highlight pictures and press **MENU/OK** to select or deselect. When the operation is complete, press **DISP/BACK** to display a confirmation dialog, then highlight **OK** and press **MENU/OK**.
- **ALL FRAMES:** A confirmation dialog will be displayed; highlight **OK** and press **MENU/OK** to delete all unprotected pictures.

CROP

Create a cropped copy of the current picture.

- 1 Display the desired picture.
 - 2 Select  **CROP** in the playback menu.
 - 3 Use the  and  buttons to zoom in and out and press the selector up, down, left, or right to scroll the picture until the desired portion is displayed.
 - 4 Press **MENU/OK** to display a confirmation dialog.
 - 5 Press **MENU/OK** again to save the cropped copy to a separate file.
- ◆ Larger crops produce larger copies; all copies have an aspect ratio of 3:2. If the size of the final copy will be **640**, **OK** will be displayed in yellow.

RESIZE

Create a cropped copy of the current picture.

- 1 Display the desired picture.
 - 2 Select  **RESIZE** in the playback menu.
 - 3 Highlight a size and press **MENU/OK** to display a confirmation dialog.
 - 4 Press **MENU/OK** again to save the resized copy to a separate file.
- ◆ The sizes available vary with the size of the original image.
-

PROTECT

Protect pictures from accidental deletion. Highlight one of the following options and press **MENU/OK**.

- **FRAME**: Protect selected pictures. Press the selector left or right to view pictures and press **MENU/OK** to select or deselect. Press **DISP/BACK** when the operation is complete.
 - **SET ALL**: Protect all pictures.
 - **RESET ALL**: Remove protection from all pictures.
- ① Protected pictures will be deleted when the memory card is formatted (🗨 92).

IMAGE ROTATE

Rotate pictures.

- 1 Display the desired picture.
 - 2 Select **IMAGE ROTATE** in the playback menu.
 - 3 Press the selector down to rotate the picture 90° clockwise, up to rotate it 90° counterclockwise.
 - 4 Press **MENU/OK**. The picture automatically be displayed in the selected orientation whenever it is played back on the camera.
- ❖ Protected pictures can not be rotated. Remove protection before rotating pictures.
 - ❖ The camera may not be able to rotate pictures created with other devices. Pictures rotated on the camera will not be rotated when viewed on a computer or on other cameras.
 - ❖ Pictures taken with **SCREEN SET-UP > AUTOROTATE PB** are automatically displayed in the correct orientation during playback (🗨 90).

👁️ RED EYE REMOVAL

Remove red-eye from portraits. The camera will analyze the image; if red-eye is detected, the image will be processed to create a copy with reduced red-eye.

1 Display the desired picture.

2 Select **👁️ RED EYE REMOVAL** in the playback menu.

3 Press **MENU/OK**.

- 🔍 Red eye may not be removed if the camera is unable to detect a face or the face is in profile. Results may differ depending on the scene. Red eye can not be removed from pictures that have already been processed using red-eye removal or pictures created with other devices.
- 🔍 The amount of time needed to process the image varies with the number of faces detected.
- 🔍 Copies created with **👁️ RED EYE REMOVAL** are indicated by a **👁️** icon during playback.
- 🔍 Red eye removal can not be performed on RAW images.

📄 SLIDE SHOW

View pictures in an automated slide show. Choose the type of show and press **MENU/OK** to start. Press **DISP/BACK** at any time during the show to view on-screen help. The show can be ended at any time by pressing **MENU/OK**.

Option	Description
NORMAL	Press the selector left or right to go back or skip ahead one frame. Select FADE-IN for fade transitions between frames.
FADE-IN	
NORMAL 👤	As above, except that camera automatically zooms in on faces.
FADE-IN 👤	
MULTIPLE	Display several pictures at once.

- 🔍 The camera will not turn off automatically while a slide show is in progress.

PHOTOBOOK ASSIST

Create books from your favorite photos (📖 72).

MARK FOR UPLOAD TO

Select pictures for upload to YouTube, Facebook or MyFinePix.com using MyFinePix Studio (Windows only).

- 1 Select **YouTube** to choose movies for upload to YouTube, **FACEBOOK** to choose photos and movies for upload to Facebook, or **MyFinePix.com** to choose photos for upload to MyFinePix.com.
 - 2 Press the selector left or right to display pictures and press **MENU/OK** to select or deselect. Press **DISP/BACK** to exit when all the desired pictures are selected.
- ❖ Only movies can be selected for upload to YouTube.
 - ❖ Only photos can be selected for upload to MyFinePix.com.
 - ❖ During playback, selected pictures are indicated by 📺 **YouTube**, 📘 **FACEBOOK** or 🌐 **MyFinepix.com** icons.
 - ❖ Choose **RESET ALL** to deselect all pictures. If the number of pictures affected is very large, some time may be required to complete the operation. Press **DISP/BACK** to exit before the operation is complete.

Uploading Pictures (Windows Only)

Selected pictures can be uploaded using the **YouTube/Facebook/MyFinePix.com Upload** option in MyFinePix Studio. For information on installing MyFinePix Studio and connecting the camera to a computer, see "Viewing Pictures on a Computer" (📖 96).

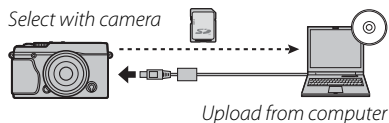
**IMAGE SEARCH**

Search for pictures (📖 71).

PC AUTO SAVE

Upload pictures to a computer over a wireless network (📖 95).

◆ For more information, visit <http://app.fujifilm-dsc.com>.

PRINT ORDER (DPOF)

Select pictures for printing on DPOF- and PictBridge-compatible devices (📖 103).

DISP ASPECT

Choose how **H**igh **D**efinition (HD) devices display pictures with an aspect ratio of 3:2 (this option is available only when an HDMI cable is connected). Select 16:9 to display the image so that it fills the screen with its top and bottom cropped out, 3:2 to display the entire image with black bands at either side.

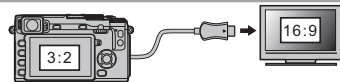

The Setup Menu

Using the Setup Menu

1 Display the setup menu.

1.1 Press **MENU/OK** to display the menu for the current mode.



1.2 Press the selector left to highlight the tab for the current menu.



1.3 Press the selector down to highlight the setup menu tab containing the desired option.

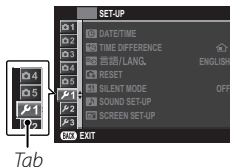

1.4 Press the selector right to place the cursor in the setup menu.



2 Adjust settings.

Highlight items and press the selector right to view options, then highlight an option and press **MENU/OK**. Press **DISP/BACK** to exit when settings are complete.

Setup Menu Options





DATE/TIME

Set the camera clock ( 19).

TIME DIFFERENCE

Switch the camera clock instantly from your home time zone to the local time at your destination when traveling. To specify the difference between local time and your home time zone:



- 1 Highlight  **LOCAL** and press **MENU/OK**.
- 2 Use the selector to choose the time difference between local time and your home time zone. Press **MENU/OK** when settings are complete.

To set the camera clock to local time, highlight  **LOCAL** and press **MENU/OK**. To set the clock to the time in your home time zone, select  **HOME**. If  **LOCAL** is selected,  will be displayed for three seconds when the camera is turned on.

言語/LANG.

Choose a language ( 19).

RESET

Reset shooting or setup menu options to default values. Custom white balance, custom settings banks created using  **EDIT/SAVE CUSTOM SETTING**, and  **DATE/TIME**,  **TIME DIFFERENCE** and  **SCREEN SET-UP > BACKGROUND COLOR** are not affected.

- 1 Highlight the desired option and press the selector right.
- 2 A confirmation dialog will be displayed; highlight **OK** and press **MENU/OK**.

SILENT MODE

Select **ON** to disable the speaker, flash, and illuminator in situations in which camera sounds or lights may be unwelcome (note that silent mode can not be enabled or disabled during movie playback).  appears in the display when silent mode is on.

SOUND SET-UP





















Adjust sound settings.

Option	Description
OPERATION VOL.	Adjust the volume of the sounds produced when camera controls are operated. Choose OFF (mute) to disable control sounds.
PLAYBACK VOLUME	Adjust the volume for movie playback.

SCREEN SET-UP

Adjust display settings.

Option	Description									
IMAGE DISP.	Choose how long images are displayed after shooting. Colors may differ slightly from those in the final image and "noise" mottling may be visible at high sensitivities.									
	<table border="1"> <thead> <tr> <th>Option</th> <th>Description</th> </tr> </thead> <tbody> <tr> <td>CONTINUOUS</td> <td>Pictures are displayed until the MENU/OK button is pressed or the shutter button is pressed halfway. To zoom in on the active focus point, press the center of the command dial; press again to cancel zoom.</td> </tr> <tr> <td>1.5 SEC</td> <td rowspan="2">Pictures are displayed for 1.5 seconds (1.5 SEC) or 0.5 seconds (0.5 SEC) or until the shutter button is pressed halfway.</td> </tr> <tr> <td>0.5 SEC</td> </tr> <tr> <td>OFF</td> <td>Pictures are not displayed after shooting.</td> </tr> </tbody> </table>	Option	Description	CONTINUOUS	Pictures are displayed until the MENU/OK button is pressed or the shutter button is pressed halfway. To zoom in on the active focus point, press the center of the command dial; press again to cancel zoom.	1.5 SEC	Pictures are displayed for 1.5 seconds (1.5 SEC) or 0.5 seconds (0.5 SEC) or until the shutter button is pressed halfway.	0.5 SEC	OFF	Pictures are not displayed after shooting.
	Option	Description								
	CONTINUOUS	Pictures are displayed until the MENU/OK button is pressed or the shutter button is pressed halfway. To zoom in on the active focus point, press the center of the command dial; press again to cancel zoom.								
	1.5 SEC	Pictures are displayed for 1.5 seconds (1.5 SEC) or 0.5 seconds (0.5 SEC) or until the shutter button is pressed halfway.								
0.5 SEC										
OFF	Pictures are not displayed after shooting.									
PREVIEW EXP. IN MANUAL MODE	Select ON to enable exposure preview in manual exposure mode. Select OFF when using the flash or on other occasions on which exposure may change when the picture is taken.									
EVF/LCD BRIGHTNESS	Control the brightness of the display.									

SCREEN SET-UP (Continued)										
Option	Description									
FRAMING GUIDELINE	Choose the type of framing grid available in shooting mode.									
	<table border="1"> <thead> <tr> <th> GRID 9</th> <th> GRID 24</th> <th> HD FRAMING</th> </tr> </thead> <tbody> <tr> <td></td> <td></td> <td></td> </tr> <tr> <td><i>For "rule of thirds" composition.</i></td> <td><i>A six-by-four grid.</i></td> <td><i>Frame HD pictures in the crop shown by the lines at the top and bottom of the display.</i></td> </tr> </tbody> </table>	 GRID 9	 GRID 24	 HD FRAMING				<i>For "rule of thirds" composition.</i>	<i>A six-by-four grid.</i>	<i>Frame HD pictures in the crop shown by the lines at the top and bottom of the display.</i>
	 GRID 9	 GRID 24	 HD FRAMING							
										
<i>For "rule of thirds" composition.</i>	<i>A six-by-four grid.</i>	<i>Frame HD pictures in the crop shown by the lines at the top and bottom of the display.</i>								
AUTOROTATE PB	Choose ON to automatically rotate "tall" (portrait-orientation) pictures during playback.									
BACKGROUND COLOR	Choose a color scheme.									
 FOCUS CHECK	If ON is selected, the camera will automatically zoom in on the view through the lens when the focus ring is rotated in manual focus mode (📖 48).									
FOCUS SCALE UNITS	Choose the units used for the focus distance indicator (📖 47).									
 FOCUS RING										
Choose the direction in which the focus ring is rotated to increase the focus distance.										
 FUNCTION (Fn) SETTING										
Choose the roles played by the Fn , Fn2 , AE , and AF buttons (📖 67).										

POWER MANAGEMENT

Adjust power management settings.

Option	Description
AUTO POWER OFF	Choose the length of time before the camera turns off automatically when no operations are performed. Shorter times increase battery life; if OFF is selected, the camera must be turned off manually. Note that in some situations the camera turns off automatically even when OFF is selected.
HIGH PERFORMANCE	Select ON for faster focus and to reduce the time needed to restart the camera after it has been turned off.

SENSOR CLEANING

Remove dust from the camera image sensor.

- **OK:** Clean sensor immediately (🗨 xi).
- **WHEN SWITCHED ON:** If this option is selected, sensor cleaning will be performed when the camera turns on.
- **WHEN SWITCHED OFF:** If this option is selected, sensor cleaning will be performed when the camera turns off (sensor cleaning is not however performed if the camera turns off in playback mode).
- 🔍 Dust that can not be removed using sensor cleaning can be removed manually (🗨 112).

FRAME NO.

New pictures are stored in image files named using a four-digit file number assigned by adding one to the last file number used. The file number is displayed during playback as shown at right. **FRAME NO.** controls whether file numbering is reset to 0001 when a new memory card is inserted or the current memory card is formatted.

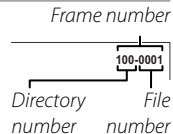

Option	Description
CONTINUOUS	Numbering continues from the last file number used or the first available file number, whichever is higher. Choose this option to reduce the number of pictures with duplicate file names.
RENEW	Numbering is reset to 0001 after formatting or when a new memory card is inserted.

- 🔍 If the frame number reaches 999-9999, the shutter release will be disabled (🗨 119).
- 🔍 Selecting **RESET** (🗨 88) sets **FRAME NO.** to **CONTINUOUS** but does not reset the file number.
- 🔍 Frame numbers for pictures taken with other cameras may differ.

COLOR SPACE

Choose the gamut of colors available for color reproduction.

Option	Description
sRGB	Recommended in most situations.
Adobe RGB	For commercial printing.

EVF/LCD SETTING

Choose a display ( 20).

WIRELESS SETTINGS

Adjust settings for connection to wireless networks.

❖ For more information, visit <http://app.fujifilm-dsc.com>.

PC AUTO SAVE SETTING

Choose an upload destination.

❖ For more information, visit <http://app.fujifilm-dsc.com>.

GEOTAGGING SET-UP

Adjust location data settings.

❖ For more information, visit <http://app.fujifilm-dsc.com>.

SAVE ORG IMAGE

Choose **ON** to save unprocessed copies of pictures taken using  **RED EYE REMOVAL**.

FORMAT



























Select **OK** to format the memory card.



















- ⓘ All data—including protected pictures—will be deleted from the memory card. Be sure important files have been copied to a computer or other storage device.
- ⓘ Do not open the battery-chamber cover during formatting.

Factory Defaults









The factory default settings for the options in the shooting and setup menus are listed below. These settings can be restored using the  **RESET** option in the setup menu (🗨 88).

Shooting Menu

Menu	Default
 ISO	200
 IMAGE SIZE	 3:2
 IMAGE QUALITY	FINE
 DYNAMIC RANGE	 100%
 FILM SIMULATION	 PROVIA/STANDARD
 FILM SIMULATION BKT	
FILM 1	 PROVIA/STANDARD
FILM 2	 Velvia/VIVID
FILM 3	 ASTIA/SOFT
 SELF-TIMER	OFF
 WHITE BALANCE	AUTO
 COLOR	(0) MID
 SHARPNESS	(0) STANDARD
 HIGHLIGHT TONE	(0) STANDARD
 SHADOW TONE	(0) STANDARD
 NOISE REDUCTION	(0) STANDARD
 LONG EXPOSURE NR	ON
 LENS MODULATION OPTIMIZER	ON
 SELECT CUSTOM SETTING	—
 EDIT/SAVE CUSTOM SETTING	—
 DISP. CUSTOM SETTING	All selected items
 MOUNT ADAPTOR SETTING	LENS 5 (50mm)
 SHOOT WITHOUT LENS	OFF

Menu	Default
 AF ILLUMINATOR	ON
 AF MODE	 AREA
 FACE DETECTION	OFF
 FOCUS AREA	—
 PRE-AF	OFF
 PHOTOMETRY	 MULTI
 AE/AF-LOCK MODE	AE&AF ON WHEN PRESSING
 AF-LOCK BUTTON	AF LOCK ONLY
 WIRELESS COMMUNICATION	—
 FLASH MODE	AUTO
 FLASH COMPENSATION	±0
 RED EYE REMOVAL	OFF
 IS MODE	 CONTINUOUS
 APERTURE SETTING	AUTO +  MANUAL
 MF ASSIST	STANDARD

Movie Menu

Menu	Default
 MOVIE MODE	 1920 × 1080 60 fps
 FACE DETECTION	ON
 FILM SIMULATION	 PROVIA/STANDARD
 WHITE BALANCE	AUTO
 MIC LEVEL ADJUSTMENT	3
 MIC/REMOTE RELEASE	 MIC

Menu	Default
DISP. CUSTOM SETTING	All selected items
IS MODE	CONTINUOUS
APERTURE SETTING	AUTO + MANUAL

■ Setup Menu

Menu	Default
DATE/TIME	—
TIME DIFFERENCE	—
言語/LANG.	—
RESET	—
SILENT MODE	OFF
SOUND SET-UP	
OPERATION VOL.	1
PLAYBACK VOLUME	7
SCREEN SET-UP	
IMAGE DISP.	OFF
PREVIEW EXP. IN MANUAL MODE	ON
EVF/LCD BRIGHTNESS	0
FRAMING GUIDELINE	GRID 9
AUTOROTATE PB	ON
BACKGROUND COLOR	—
FOCUS CHECK	OFF
FOCUS SCALE UNITS	METERS
FOCUS RING	CW

Menu	Default
FUNCTION (Fn) SETTING	
Fn BUTTON	ISO
Fn2 BUTTON	WHITE BALANCE
AF BUTTON	FOCUS AREA
AE BUTTON	PHOTOMETRY
POWER MANAGEMENT	
AUTO POWER OFF	2 MIN
HIGH PERFORMANCE	OFF
SENSOR CLEANING	
OK	—
WHEN SWITCHED ON	OFF
WHEN SWITCHED OFF	ON
FRAME NO.	CONTINUOUS
COLOR SPACE	sRGB
EVF/LCD SETTING	EYE SENSOR
WIRELESS SETTINGS	
GENERAL SETTINGS	—
RESIZE IMAGE FOR SMARTPHONE	ON
PC AUTO SAVE SETTINGS	—
PC AUTO SAVE SETTING	—
GEOTAGGING SET-UP	
GEOTAGGING	ON
LOCATION INFO	ON
SAVE ORG IMAGE	OFF
FORMAT	—

Connections

Wireless Transfer

Access wireless networks and connect to computers, smartphones, or tablets. For downloads and other information, visit <http://app.fujifilm-dsc.com/>.

Wireless Connections: Smartphones

Install the “FUJIFILM Camera Application” app on your smartphone to browse the images on the camera, download selected images, or copy location data to the camera. You can also upload pictures from the camera using the  **WIRELESS COMMUNICATION** options in the camera shooting and playback menus or by pressing the **Wi-Fi** button in playback mode.

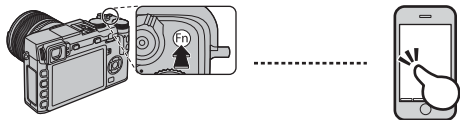

Wireless Connections: Computers

Once you have installed the “FUJIFILM PC AutoSave” application and configured your computer as a destination for the images copied from the camera, you can upload pictures from the camera using the  **PC AUTO SAVE** option in the camera playback menu or by pressing and holding the **Wi-Fi** button in playback mode.

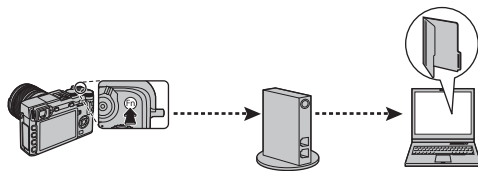

Viewing Pictures on a Computer

The supplied software can be used to copy pictures to a computer, where they can be stored, viewed, organized, and printed. Before proceeding, install the software as described below. **Do not connect the camera to the computer until installation is complete.**

Windows: Installing MyFinePix Studio

1 Confirm that the computer meets the following system requirements:

	Windows 8/Windows 7 (Service Pack 1)/ Windows Vista (Service Pack 2)¹	Windows XP (Service Pack 3)¹
CPU	3 GHz Pentium 4 or better (2.4 GHz Core 2 Duo or better ²)	2 GHz Pentium 4 or better (2.4 GHz Core 2 Duo or better ²)
RAM	1 GB or more	512 MB or more (1 GB or more ²)
Free disk space	2 GB or more	
GPU	Supports DirectX 9 or later (recommended)	Supports DirectX 7 or later (required; performance not guaranteed with other GPUs)
Video	1024 × 768 pixels or more with 24-bit color or better	
Other	<ul style="list-style-type: none">• Built-in USB port recommended. Operation is not guaranteed with other USB ports.• .NET Framework 3.5 Service Pack 1 required when uploading images or using Map Viewer.• Internet connection (broadband recommended) required to install .NET Framework (if necessary), to use auto update feature, and when performing such tasks as sharing pictures on-line or via e-mail.	

1 Other versions of Windows are not supported. Only pre-installed operating systems are supported; operation is not guaranteed on home-built computers or computers that have been upgraded from earlier versions of Windows.

2 Recommended when displaying HD movies.

2 Start the computer. Log in to an account with administrator privileges before proceeding.

3 Exit any applications that may be running and insert the installer CD in a CD-ROM drive.

Windows 8/Windows 7/Windows Vista

If an AutoPlay dialog is displayed, click **SETUP.EXE**. A “User Account Control” dialog will then be displayed; click **Yes** (Windows 8/Windows 7) or **Allow** (Windows Vista).

The installer will start automatically; click **Install MyFinePix Studio** and follow the on-screen instructions to install MyFinePix Studio and RAW FILE CONVERTER.

If the Installer Does Not Start Automatically

If the installer does not start automatically, follow the steps below.

- **Windows 8:** Select **Desktop** from the Start screen, then select **File Explorer** on the desktop taskbar and choose **Computer** in the navigation panel. Double-click the drive containing the installer CD and follow the on-screen instructions.
- **Other versions of Windows:** Select **Computer** or **My Computer** from the **Start** menu, then double-click the **FINEPIX** CD icon to open the FINEPIX CD window and double-click **setup** or **SETUP.EXE**.

4 If prompted to install Windows Media Player or DirectX, follow the on-screen instructions to complete installation.

5 Remove the installer CD from the CD-ROM drive when installation is complete. Store the installer CD in a dry location out of direct sunlight in case you need to re-install the software.

Installation is now complete. Proceed to “Connecting the Camera” (📖 99).

Macintosh: Installing RAW FILE CONVERTER

RAW FILE CONVERTER is used to view RAW images on your computer.

- 1 Confirm that the computer meets the following system requirements:

CPU	Intel (Core 2 Duo or better)
OS	Pre-installed copies of Mac OS X version 10.6–10.8 (visit http://www.fujifilm.com/support/digital_cameras/compatibility/ for more information).
RAM	1 GB or more
Free disk space	A minimum of 200 MB required for installation with 400 MB available when RAW FILE CONVERTER is running
Video	1,024 × 768 pixels or more with 24-bit color or better

- 2 After starting the computer and quitting any applications that may be running, insert the installer CD in a CD-ROM drive and double-click **SILKYRFXEXInstaller**.
- 3 Enter an administrator name and password when prompted and click **OK**, then follow the on-screen instructions to install. Click **Exit** to quit the installer when installation is complete.
- 4 Remove the installer CD from the CD-ROM drive. Note that you may be unable to remove the CD if Safari is running; if necessary, quit Safari before removing the CD. Store the installer CD in a dry location out of direct sunlight in case you need to re-install the software.

Installation is now complete. Proceed to “Connecting the Camera” (📖 99).

Macintosh: Importing Pictures

Still images and movies can be imported using Image Capture or other standard Mac OS applications.

Connecting the Camera

- 1 Find a memory card containing pictures you want to copy to the computer and insert the card into the camera (📖 14).
 - ◆ Windows users may require the Windows CD when starting the software for the first time.
 - ⌚ Loss of power during transfer could result in loss of data or damage to the memory card. Insert a fresh or fully-charged battery before connecting the camera.
- 2 Turn the camera off and connect a USB cable (available separately from third-party suppliers) as shown, making sure the connectors are fully inserted. Connect the camera directly to the computer; do not use a USB hub or keyboard.

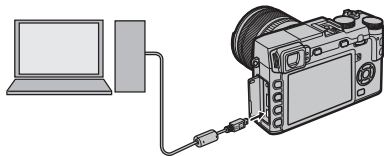

- ⌚ The USB cable must be no more than 1.5 m (4.9 ft.) long and be suitable for data transfer.
- 3 Turn the camera on.
 - 4 Upload pictures in MyFinePix Studio and follow the on-screen instructions to copy pictures to the computer. To exit without copying pictures, click **Cancel**.

For more information on using the supplied software, start the application and select the appropriate option from the **Help** menu.

- ❗ If a memory card containing a large number of images is inserted, there may be a delay before the software starts and you may be unable to import or save images. Use a memory card reader to transfer pictures.
- ❗ Make sure that the computer does not display a message stating that copying is in progress and that the indicator lamp is out before turning the camera off or disconnecting the USB cable (if the number of images copied is very large, the indicator lamp may remain lit after the message has cleared from the computer display). Failure to observe this precaution could result in loss of data or damage to the memory card.
- ❗ Disconnect the camera before inserting or removing memory cards.
- ❗ In some cases, it may not be possible to access pictures saved to a network server using the supplied software in the same way as on a standalone computer.
- ❗ The user bears all applicable fees charged by the phone company or Internet service provider when using services that require an Internet connection.

Disconnecting the Camera

After confirming that the indicator lamp is out, turn the camera off and disconnect the USB cable.

Uninstalling the Supplied Software

Only uninstall the supplied software when it is no longer required or before beginning reinstallation. After quitting the software and disconnecting the camera, drag “RAW FILE CONVERTER EX powered by SILKYPIX” from “Applications” into the Trash and select **Empty Trash** in the **Finder** menu (Macintosh), or open the control panel and use “Programs and Features” (Windows 8/Windows 7/Windows Vista) or “Add or Remove Programs” (Windows XP) to uninstall MyFinePix Studio. Under Windows, one or more confirmation dialogs may be displayed; read the contents carefully before clicking **OK**.

Printing Pictures via USB

If the printer supports PictBridge, the camera can be connected directly to the printer and pictures can be printed without first being copied to a computer. Note that depending on the printer, not all the functions described below may be supported.



Connecting the Camera

- 1 Connect a USB cable (available separately from third-party suppliers) as shown and turn the printer on.

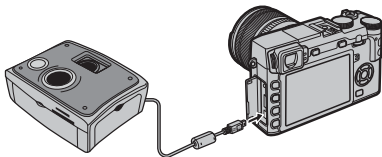

① The USB cable must be no more than 1.5 m (4.9 ft.) long and be suitable for data transfer.

- 2 Turn the camera on. **USB** will be displayed in the monitor, followed by the PictBridge display shown below at right.

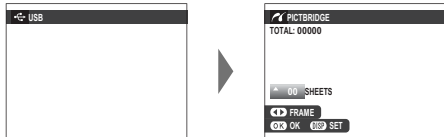

- ◆ Pictures can be printed from memory cards that has been formatted in the camera.
- ◆ Page size, print quality, and border selections are made using the printer.

Printing Selected Pictures

- 1 Press the selector left or right to display a picture you wish to print.



◆ To print one copy of the current picture, proceed directly to Step 3.

- 2 Press the selector up or down to choose the number of copies (up to 99). Repeat steps 1–2 to select additional pictures.



- 3 Press **MENU/OK** to display a confirmation dialog.

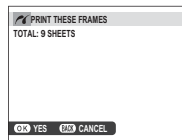



- 4 Press **MENU/OK** to start printing.



Printing the Date of Recording

To print the date of recording on pictures, press **DISP/BACK** in the PictBridge display and select **PRINT WITH DATE**  (to print pictures without the date of recording, select **PRINT WITHOUT DATE**). To ensure that the date is correct, set the camera clock before taking pictures. Some printers do not support date printing. See the printer manual for details.

Printing the DPOF Print Order

To print the print order created with  **PRINT ORDER (DPOF)** in the playback menu ( 86):

- 1 In the PictBridge display, press **DISP/BACK** to open the PictBridge menu. 
- 2 Press the selector up or down to highlight  **PRINT DPOF**. 

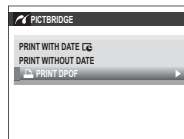

- 3 Press **MENU/OK** to display a confirmation dialog. 

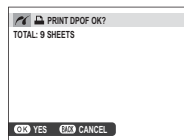

- 4 Press **MENU/OK** to start printing. 

During Printing

The message shown at right is displayed during printing. Press **DISP/BACK** to cancel before all pictures are printed (depending on the printer, printing may end before the current picture has printed).

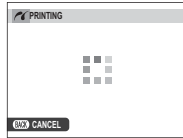

If printing is interrupted, turn the camera off and then on again.

Disconnecting the Camera

Confirm that the above message is not displayed and turn the camera off. Disconnect the USB cable.

Creating a DPOF Print Order



The  **PRINT ORDER (DPOF)** option in the playback menu can be used to create a digital “print order” for PictBridge-compatible printers or devices that support DPOF.

DPOF

DPOF (**D**igital **P**rint **O**rder **F**ormat) is standard that allows pictures to be printed from “print orders” stored on the memory card. The information in the order includes the pictures to be printed and the number of copies of each picture.



■ WITH DATE / WITHOUT DATE

To modify the DPOF print order, select  **PRINT ORDER (DPOF)** in the playback menu and press the selector up or down to highlight **WITH DATE ** or **WITHOUT DATE**.

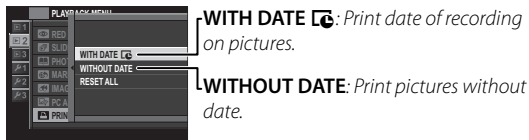

Press **MENU/OK** and follow the steps below.

1 Press the selector left or right to display a picture you wish to include in or remove from the print order.



2 Press the selector up or down to choose the number of copies (up to 99). To remove a picture from the order, press the selector down until the number of copies is 0.

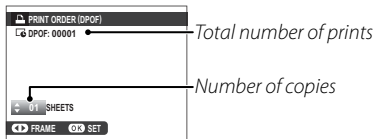

3 Repeat steps 1–2 to complete the print order. Press **MENU/OK** to save the print order when settings are complete, or **DISP/BACK** to exit without changing the print order.



4 The total number of prints is displayed in the monitor. Press **MENU/OK** to exit.



The pictures in the current print order are indicated by a  icon during playback.



■ RESET ALL

To cancel the current print order, select **RESET ALL** for **PRINT ORDER (DPOF)**. The confirmation shown at right will be displayed; press **MENU/OK** to remove all pictures from the order.

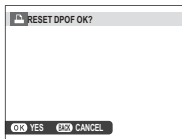

- ◆ Print orders can contain a maximum of 999 pictures.
- ◆ If a memory card is inserted containing a print order created by another camera, the message shown at right will be displayed. Pressing **MENU/OK** cancels the print order; a new print order must be created as described above.

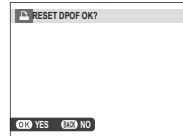

Viewing Pictures on TV

To show pictures to a group, connect the camera to a TV using an HDMI cable (available separately from third-party suppliers; note that the TV can only be used for playback, not shooting).

- 1 Turn the camera off.
- 2 Connect the cable as shown below.

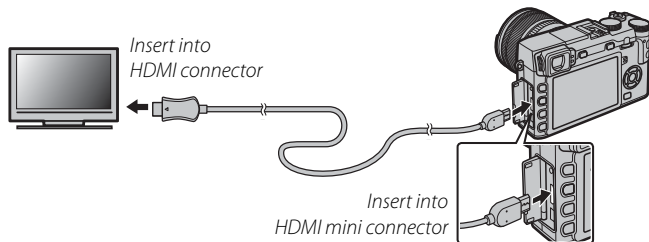

- 3 Use an HDMI cable no more than 1.5 m (4.9 ft.) long.
 - ◆ Be sure the connectors are fully inserted.
- 4 Tune the television to the HDMI input channel. See the documentation supplied with the television for details.
- 4 Turn the camera on and press  button. The camera monitor turns off and pictures and movies are played back on the TV. Note that the camera volume controls have no effect on sounds played on the TV; use the television volume controls to adjust the volume.
 - ◆ The USB cable can not be used while an HDMI cable is connected.
 - ◆ Some televisions may briefly display a black screen when movie playback begins.

Technical Notes

Optional Accessories

The camera supports a wide range of accessories from FUJIFILM and other manufacturers.

Accessories from FUJIFILM

The following optional accessories are available from FUJIFILM. For the latest information on the accessories available in your region, check with your local FUJIFILM representative or visit http://www.fujifilm.com/products/digital_cameras/index.html.

Rechargeable Li-ion batteries

NP-W126: Additional large-capacity NP-W126 rechargeable batteries can be purchased as required.



Battery chargers

BC-W126: Replacement battery chargers can be purchased as required. At +20°C/+68°F, the BC-W126 charges an NP-W126 in about 150 minutes.

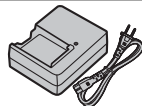

Remote releases

RR-90: Use to reduce camera shake or keep the shutter open during a time exposure.

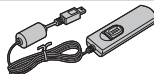

Stereo microphones

MIC-ST1: An external microphone for movie recording.



FUJINON Lenses

XF-series lenses: Interchangeable lenses for use exclusively with the FUJIFILM X-mount.



XC-series lenses: Interchangeable lenses for use exclusively with the FUJIFILM X-mount.

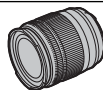

Shoe-mounted flash units

EF-20: This clip-on flash unit (powered by two AA batteries) has a Guide Number of 20/65 (ISO 100, m/ft.) and supports TTL flash control. The flash head can be rotated upwards 90° for bounce lighting.



EF-42: This clip-on flash unit (powered by four AA batteries) has a Guide Number of 42/137 (ISO 100, m/ft.) and supports TTL flash control and auto power zoom in the range 24–105 mm (35 mm format equivalent). The flash head can be rotated 90° up, 180° left, or 120° right for bounce lighting.



EF-X20: This clip-on flash unit has a Guide Number of 20/65 (ISO 100, m/ft.).



Mount Adapters

FUJIFILM M MOUNT ADAPTER: Allows the camera to be used with a wide selection of M-mount lenses.

Protector Filters

PRF-39/PRF-49S/PRF-52/PRF-58/PRF-62: Use to protect the lens.

Grips

HG-XE1: Features an improved grip.

Leather cases

BLC-XE1: This case combines practicality with the luxury of leather and comes with a shoulder strap made of the same material, as well as a cloth that can be used to wrap the camera before putting it in the case and on other occasions. Pictures can be taken and batteries and memory cards inserted or removed with the camera still in its case.

Front lens caps

FLCP-39/FLCP-52/FLCP-58/FLCP-62: Protect the front lens element when the lens is not in use.

Rear lens caps

RLCP-001: Protect the rear lens element when the lens is not attached to the camera.

Body caps

BCP-001: Cover the camera lens mount when no lens is attached.

Connecting the Camera to Other Devices

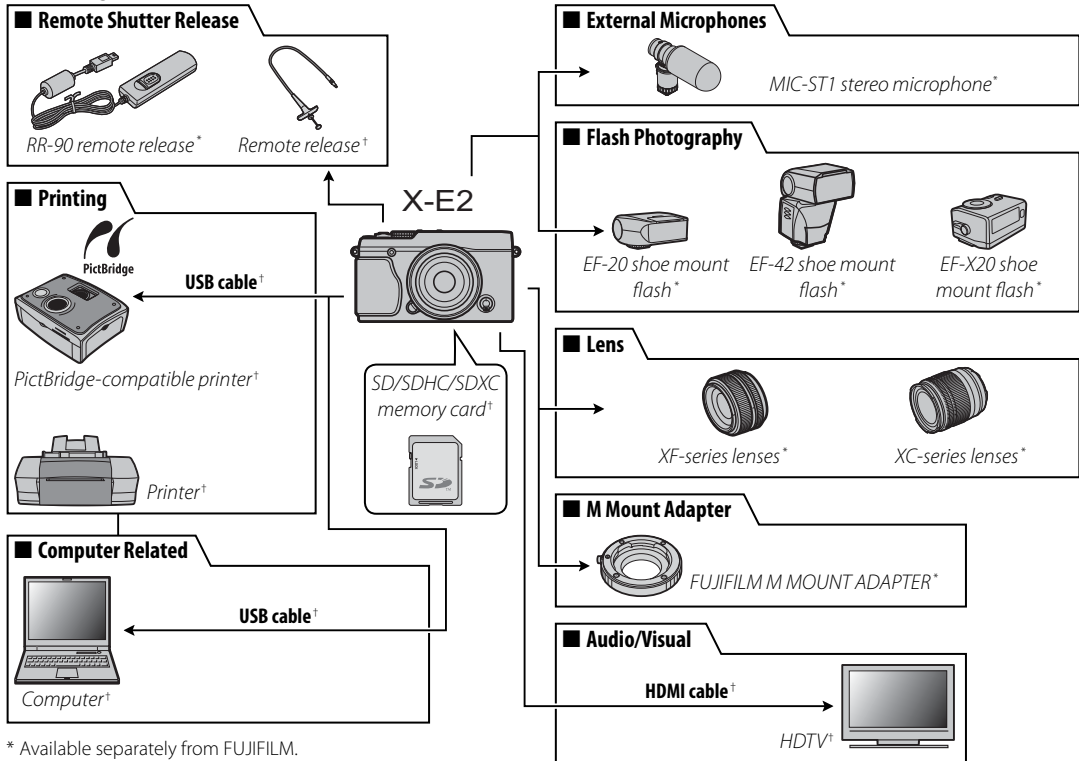

* Available separately from FUJIFILM.

† Available separately from third-party suppliers. USB and HDMI cables must be no more than 1.5 m (4.9 ft.) long.

Caring for the Camera

To ensure continued enjoyment of the product, observe the following precautions.

Storage and Use

If the camera will not be used for an extended period, remove the battery and memory card. Do not store or use the camera in locations that are:

- exposed to rain, steam, or smoke
- very humid or extremely dusty
- exposed to direct sunlight or very high temperatures, such as in a closed vehicle on a sunny day
- extremely cold
- subject to strong vibration
- exposed to strong magnetic fields, such as near a broadcasting antenna, power line, radar emitter, motor, transformer, or magnet
- in contact with volatile chemicals such as pesticides
- next to rubber or vinyl products

■ Water and Sand

Exposure to water and sand can also damage the camera and its internal circuitry and mechanisms. When using the camera at the beach or seaside, avoid exposing the camera to water or sand. Do not place the camera on a wet surface.

■ Condensation

Sudden increases in temperature, such as occur when entering a heated building on a cold day, can cause condensation inside the camera. If this occurs, turn the camera off and wait an hour before turning it on again. If condensation forms on the memory card, remove the card and wait for the condensation to dissipate.

Traveling

Keep the camera in your carry-on baggage. Checked baggage may suffer violent shocks that could damage the camera.

Cleaning the Image Sensor

Multiple photographs marred by spots or blotches in identical locations may indicate the presence of dust on the camera image sensor. Clean the sensor using the  **SENSOR CLEANING** option in the setup menu (📖 91); if the problem persists, you can clean the sensor manually as described below. Note that there will be a charge to repair or replace the image sensor if it is damaged during cleaning.

- 1 Use a blower (not a brush) to remove dust from the sensor.

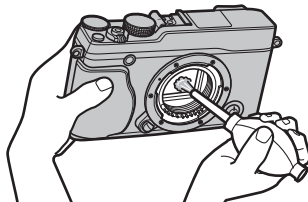

- ① Do not use a brush or blower brush. Failure to observe this precaution could damage the sensor.
- 2 Check whether the dust has been successfully removed.
 - ◆ Repeat Steps 1 and 2 as necessary.
- 3 Replace the body cap or lens.

Troubleshooting

Problems and Solutions

■ Power and Battery

Problem	Solution
The camera does not turn on.	<ul style="list-style-type: none">• The battery is exhausted: Charge the battery (📖 13) or insert a fully-charged spare battery (📖 14).• The battery is inserted incorrectly: Reinsert in the correct orientation (📖 14).• The battery-chamber cover is not latched: Latch the battery-chamber cover (📖 15).
The monitor does not turn on.	The monitor may not turn on if the camera is turned off and then on again very quickly. Press the shutter button halfway to activate the monitor.
The battery runs down quickly.	<ul style="list-style-type: none">• The battery is cold: Warm the battery by placing it in a pocket or other warm place and reinsert it in the camera immediately before taking a picture.• There is dirt on the battery terminals: Clean the terminals with a soft, dry cloth.• ON is selected for 液晶 PRE-AF: Turn PRE-AF off (📖 78).• The battery has been charged many times: The battery has reached the end of its charging life. Purchase a new battery.
The camera turns off suddenly.	The battery is exhausted: Charge the battery (📖 13) or insert a fully-charged spare battery (📖 14).
Charging does not start.	Reinsert the battery in the correct orientation and make sure that the charger is plugged in (📖 13).
Charging is slow.	Charge the battery at room temperature (📖 iv).
The charging lamp blinks, but the battery does not charge.	<ul style="list-style-type: none">• There is dirt on the battery terminals: Clean the terminals with a soft, dry cloth.• The battery has been charged many times: The battery has reached the end of its charging life. Purchase a new battery. If the battery still fails to charge, contact your FUJIFILM dealer.

■ Menus and Displays

Problem	Solution
Display is not in English.	Select ENGLISH for 言語/LANG. (📖 88).

■ Shooting

Problem	Solution
No picture is taken when the shutter button is pressed.	<ul style="list-style-type: none"> • The memory card is full: Insert a new memory card or delete pictures (📖 14, 29). • The memory card is not formatted: Format the memory card (📖 92). • There is dirt on the memory card contacts: Clean the contacts with a soft, dry cloth. • The memory card is damaged: Insert a new memory card (📖 14). • The battery is exhausted: Charge the battery (📖 13) or insert a fully-charged spare battery (📖 14). • The camera has turned off automatically: Turn the camera on (📖 18). • The indicator lamp was orange when you attempted to record a panorama: Wait until the indicator lamps turns off (📖 3).
Mottling (“noise”) appears in the monitor or viewfinder when the shutter button is pressed halfway.	Gain is increased to aid composition when the subject is poorly lit and aperture is stopped down, which may result in noticeable mottling when images are previewed in the displays. Images taken with the camera are unaffected.
The camera does not focus.	<ul style="list-style-type: none"> • The subject is close to the camera: Select macro mode (📖 32), if available. If macro mode is unavailable, choose a different shooting mode (📖 127). • The subject is far away from the camera: Cancel macro mode (📖 32). • The subject is not suited to autofocus: Use focus lock (📖 51) or manual focus (📖 47).
Intelligent Face Detection is not available.	Intelligent Face Detection is not available in the current shooting mode: Choose a different shooting mode (📖 127).
No face is detected.	<ul style="list-style-type: none"> • The subject’s face is obscured by sunglasses, a hat, long hair, or other objects: Remove the obstructions. • The subject’s face occupies only a small area of the frame: Change the composition so that the subject’s face occupies a larger area of the frame (📖 51). • The subject’s head is tilted or horizontal: Ask the subject to hold their head straight. • The camera is tilted: Keep the camera level. • The subject’s face is poorly lit: Shoot in bright light.
Wrong subject is selected.	The selected subject is closer to the center of the frame than the main subject. Recompose the picture or turn face detection off and frame the picture using focus lock (📖 51).

Problem	Solution
The flash does not fire.	<ul style="list-style-type: none"> • The flash can not be used at current settings: See the list of the settings that can be used with the flash (📖 128). • The flash is lowered: Raise the flash (📖 30). • The battery is exhausted: Charge the battery (📖 13) or insert a fully-charged spare battery (📖 14). • The camera is in bracketing or continuous mode: Select single frame mode (📖 57, 58). • The camera is in silent mode: Turn silent mode off (📖 88).
Some flash modes are not available.	The camera is in silent mode. Turn silent mode off (📖 88).
The flash does not fully light the subject.	<ul style="list-style-type: none"> • The subject is not in range of the flash: Position the subject in range of the flash (📖 123). • The flash window is obstructed: Hold the camera correctly (📖 24). • Shutter speed is faster than $\frac{1}{180}$ s: Choose a slower shutter speed (📖 31, 38, 40).
Pictures are blurred.	<ul style="list-style-type: none"> • The lens is dirty: Clean the lens (📖 xi). • The lens is blocked: Keep objects away from the lens. • !AF is displayed during shooting and the focus frame is displayed in red: Check focus before shooting (📖 25). • ! is displayed during shooting: Use the flash or mount the camera on a tripod (📖 30).
Pictures are mottled.	<ul style="list-style-type: none"> • Shutter speed is slow and the ambient temperature is high: This is normal and does not indicate a malfunction. • The camera has been used continuously at high temperatures or a temperature warning is displayed: Turn the camera off and wait for it to cool down.

■ Playback

Problem	Solution
Pictures are grainy.	The pictures were taken with a different make or model of camera.
Playback zoom is unavailable.	The pictures were created using RESIZE or with a different make or model of camera.
No sound in movie playback.	<ul style="list-style-type: none"> • Playback volume is too low: Adjust playback volume (89). • The microphone was obstructed: Hold the camera correctly during recording (2, 33). • The speaker is obstructed: Hold the camera correctly during playback (2, 35). • The camera is in silent mode: Turn silent mode off (88).
Selected pictures are not deleted.	Some of the pictures selected for deletion are protected. Remove protection using the device with which it was originally applied (83).
File numbering is unexpectedly reset.	The battery-chamber cover was opened while the camera was on. Turn the camera off before opening the battery-chamber cover (14, 18).





■ Connections/Miscellaneous



Problem	Solution
Problem connecting or uploading pictures to smartphone.	<ul style="list-style-type: none"> • The smartphone is too far away: Move the devices closer. • Nearby devices are causing radio interference: Move the camera and smartphone away from microwave ovens or cordless phones.
Can not upload images.	<ul style="list-style-type: none"> • The smartphone is connected to another device: The smartphone and camera can connect to only one device at a time. End the connection and try again. • There are several smartphones in the vicinity: Try connecting again. The presence of multiple smartphones can make connection difficult.
Selecting TRANSMIT or tapping has no effect.	The current image is a movie or was created on another device and can not be uploaded to a smartphone.
Smartphone will not display pictures.	Select ON for WIRELESS SETTING > RESIZE IMAGE FOR SMARTPHONE . Selecting OFF increases upload times for larger images; in addition, some phones may not display images over a certain size.





Problem	Solution
No picture or sound on TV.	<ul style="list-style-type: none"> • The camera is not properly connected: Connect the camera properly (📖 106). Note that once the camera is connected, pictures will be displayed on the TV instead of in the camera monitor. • Input on the television is set to “TV”: Set input to “HDMI”. • The volume on the TV is too low: Use the controls on the television to adjust the volume.
The computer does not recognize the camera.	Be sure the camera and computer are correctly connected (📖 99).
Can not transfer RAW or JPEG files to computer.	Use the bundled software to transfer pictures (📖 96).
Pictures can not be printed.	<ul style="list-style-type: none"> • The camera is not properly connected: Connect the camera correctly (📖 101). • The printer is off: Turn the printer on.
Only one copy is printed/ the date is not printed.	The printer is not PictBridge compatible.
The camera is unresponsive.	<ul style="list-style-type: none"> • Temporary camera malfunction: Remove and reinsert the battery (📖 14, 16). • The battery is exhausted: Charge the battery (📖 13) or insert a fully-charged spare battery (📖 14).
The camera does not function as expected.	Remove and reinsert the battery (📖 14, 16). If the problem persists, contact your FUJIFILM dealer.
No sound.	Turn silent mode off (📖 88).

Warning Messages and Displays

The following warnings appear in the display.

Warning	Description
 (red)	Low battery. Charge the battery (📖 13) or insert a fully-charged spare battery (📖 14).
 (blinks red)	Battery exhausted. Charge the battery (📖 13) or insert a fully-charged spare battery (📖 14).
	Slow shutter speed. Pictures may be blurred; use the flash or a tripod.
!AF (displayed in red with red focus frame)	The camera can not focus. Try one of the following solutions: <ul style="list-style-type: none">• Use focus lock to focus on another subject at the same distance, then recompose the picture (📖 51).• Use macro mode to focus when taking close-ups (📖 32).
Aperture or shutter speed displayed in red	The subject is too bright or too dark and the picture will be over- or under-exposed. Use the flash for additional lighting when taking photographs of poorly-lit subjects (📖 30).
FOCUS ERROR	
TURN OFF THE CAMERA AND TURN ON AGAIN	Camera malfunction. Turn the camera off and then on again. If the message persists, contact a FUJIFILM dealer.
LENS CONTROL ERROR	
LENS ERROR	Turn the camera off, remove the lens, and clean the mounting surfaces, then replace the lens and turn the camera on. If the problem persists, contact a FUJIFILM dealer.
BUSY	The memory card is incorrectly formatted. Use the camera to format the card (📖 92).
CARD NOT INITIALIZED	<ul style="list-style-type: none">• The memory card is not formatted or the memory card has been formatted in a computer or other device: Format the memory card using the  FORMAT option in the camera setup menu (📖 92).• The memory card contacts require cleaning: Clean the contacts with a soft, dry cloth. If the message is repeated, format the card (📖 92). If the message persists, replace the card.• Camera malfunction: Contact a FUJIFILM dealer.
PROTECTED CARD	The memory card is locked. Unlock the card (📖 15).

Warning	Description
CARD ERROR	<ul style="list-style-type: none"> • The memory card is not formatted for use in the camera: Format the card (📖 92). • The memory card contacts require cleaning or the memory card is damaged: Clean the contacts with a soft, dry cloth. If the message is repeated, format the card (📖 92). If the message persists, replace the card. • Incompatible memory card: Use a compatible card (📖 17). • Camera malfunction: Contact a FUJIFILM dealer.
SD MEMORY FULL	The memory card is full and pictures can not be recorded. Delete pictures (📖 29) or insert a memory card with more free space (📖 14).
NO CARD	The shutter can only be released when a memory card is inserted. Insert a memory card.
WRITE ERROR	<ul style="list-style-type: none"> • Memory card error or connection error: Reinsert the card or turn the camera off and then on again. If the message persists, contact a FUJIFILM dealer. • Not enough memory remaining to record additional pictures: Delete pictures (📖 29) or insert a memory card with more free space (📖 14). • The memory card is not formatted: Format the memory card (📖 92).
READ ERROR	<ul style="list-style-type: none"> • The file is corrupt or was not created with the camera: The file can not be viewed. • The memory card contacts require cleaning: Clean the contacts with a soft, dry cloth. If the message is repeated, format the card (📖 92). If the message persists, replace the card. • Camera malfunction: Contact a FUJIFILM dealer.
FRAME NO. FULL	The camera has run out of frame numbers (current frame number is 999-9999). Format the memory card and select RENEW for  FRAME NO. Take a picture to reset frame numbering to 100-0001, then select CONTINUOUS for  FRAME NO. (📖 91).
TOO MANY FRAMES	<ul style="list-style-type: none"> • A search has returned more than 30,000 results: Choose a search that returns fewer results. • More than 999 images are selected for deletion: Choose fewer images.

Warning	Description
PROTECTED FRAME	An attempt was made to delete or rotate a protected picture. Remove protection and try again (🗨 83).
CAN NOT CROP	The picture is damaged or was not created with the camera.
 CANNOT EXECUTE	Red-eye removal can not be applied to pictures created with other devices.
 CANNOT EXECUTE	Red-eye removal can not be applied to movies.
CAN NOT ROTATE	The selected picture can not be rotated.
 CAN NOT ROTATE	Movies can not be rotated.
DPOF FILE ERROR	The DPOF print order on the current memory card contains more than 999 images. Copy the pictures to a computer and create a new print order.
CAN NOT SET DPOF	The picture can not be printed using DPOF.
 CAN NOT SET DPOF	Movies can not be printed using DPOF.
COMMUNICATION ERROR	A connection error occurred while pictures were being printed or copied to a computer or other device. Confirm that the device is turned on and that the USB cable is connected.
PRINTER ERROR	Printer out of paper or ink, or other printer error. Check printer (see printer manual for details). To resume printing, turn the printer off and then turn it back on.
PRINTER ERROR RESUME?	Printer out of paper or ink, or other printer error. Check printer (see printer manual for details). If printing does not resume automatically, press MENU/OK to resume.
CANNOT BE PRINTED	An attempt was made to print a movie, a picture not created with the camera, or a picture in a format not supported by the printer. Movies, RAW images, and some pictures created with other devices can not be printed; if the picture is a still picture created with the camera, check the printer manual to confirm that the printer supports the JFIF-JPEG or Exif-JPEG format. If it does not, the pictures can not be printed.
	Turn the camera off and wait for it to cool. Mottling may increase in pictures taken when this warning is displayed.

Appendix

Memory Card Capacity

The following table shows the recording time or number of pictures available at different image sizes. All figures are approximate; file size varies with the scene recorded, producing wide variations in the number of files that can be stored. The number of exposures or length remaining may not diminish at an even rate.

Capacity		4 GB		8 GB	
		FINE	NORMAL	FINE	NORMAL
Photographs	3:2	600	960	1210	1910
	RAW	120		230	
Movies ¹	1920×1080 60 fps ²	13 min.		26 min.	
	1920×1080 30 fps ²				
	1280×720 60 fps ³	25 min.		51 min.	
1280×720 30 fps ³					







¹ Use a CLASSIC card or better.

² Individual movies can not exceed 14 minutes in length.

³ Individual movies can not exceed 27 minutes in length.

Specifications

System	
Model	FUJIFILM X-E2 digital camera
Effective pixels	16.3 million
Image sensor	23.6 mm × 15.6 mm (APS-C), X-Trans CMOS II sensor with square pixels and primary color filter
Storage media	FUJIFILM-recommended SD/SDHC/SDXC memory cards
File system	Compliant with Design Rule for Camera File System (DCF), Exif 2.3, and Digital Print Order Format (DPOF)
File format	<ul style="list-style-type: none">• Still pictures: Exif 2.3 JPEG (compressed); RAW (original RAF format, special-purpose software required); RAW+JPG available• Movies: H.264 standard with stereo sound (MOV)
Image size	<ul style="list-style-type: none">• L 3:2: 4,896 × 3,264• M 3:2: 3,456 × 2,304• S 3:2: 2,496 × 1,664• L 16:9: 4,896 × 2,760• M 16:9: 3,456 × 1,944• S 16:9: 2,496 × 1,408• L panorama: 2,160 × 9,600 (vertical) / 9,600 × 1,440 (horizontal)• M panorama: 2,160 × 6,400 (vertical) / 6,400 × 1,440 (horizontal)• L 1:1: 3,264 × 3,264• M 1:1: 2,304 × 2,304• S 1:1: 1,664 × 1,664
Lens mount	FUJIFILM X mount
Sensitivity	Standard output sensitivity equivalent to ISO 200–6400 in increments of 1/3 EV; AUTO; extended output sensitivity equivalent to ISO 100, 12800, or 25600
Metering	256-segment through-the-lens (TTL) metering; MULTI, SPOT, AVERAGE
Exposure control	Programmed AE (with program shift); shutter-priority AE; aperture-priority AE; manual exposure
Exposure compensation	–3 EV – +3 EV in increments of 1/3 EV
Shutter speed (mechanical shutter)	<ul style="list-style-type: none">• P mode: 1/4 sec. to 1/4,000 sec.• Bulb: Max. 60 min.• Time: 30 sec. to 1/2 sec.• All other modes: 30 sec. to 1/4,000 sec.

System			
Continuous	Mode		Frames per burst
			Up to approximately 28
			Until card is full
<ul style="list-style-type: none"> ◆ Use a CLASS[®] card or better. ◆ The frame rate varies with shooting conditions and the number of images recorded. 			
Focus	<ul style="list-style-type: none"> • Mode: Single or continuous AF; manual focus with focus ring • Focus-area selection: Multi, area with focus area size selection; 49 (7 × 7) areas available in viewfinder and LCD monitor • Autofocus system: Intelligent hybrid AF (TTL contrast-detect/phase-detection AF) with AF-assist illuminator 		
White balance	Custom, color temperature selection, auto, direct sunlight, shade, daylight fluorescent, warm white fluorescent, cool white fluorescent, incandescent, underwater		
Self-timer	Off, 2 sec., 10 sec.		
Flash	<ul style="list-style-type: none"> • Type: Manual pop-up flash unit • Guide number: Approx. 7/22 (ISO 200, m/ft.) 		
Mode	Auto, fill flash, off, slow sync, rear-curtain sync, commander (red-eye removal off); auto with red-eye removal, fill flash with red-eye removal, off, slow sync with red-eye removal, rear-curtain sync with red-eye removal, commander (red-eye removal on)		
Hot shoe	Accessory shoe with TTL contacts		
Viewfinder	0.5-in., 2,360k-dot color OLED viewfinder with diopter adjustment (−4 to +2m ⁻¹); eye point approx. 23 mm; frame coverage approx. 100%		
LCD monitor	3.0-in/7.6 cm., 1,040k-dot color LCD monitor; frame coverage approx. 100%		
Movies	<ul style="list-style-type: none"> •  1920 × 1080 60fps: Frame size 1,920 × 1,080 (1080p); 60 fps; stereo sound •  1920 × 1080 30fps: Frame size 1,920 × 1,080 (1080p); 30 fps; stereo sound •  1280 × 720 60fps: Frame size 1,280 × 720 (720p); 60 fps; stereo sound •  1280 × 720 30fps: Frame size 1,280 × 720 (720p); 30 fps; stereo sound 		

Input/output terminals**HDMI output** HDMI mini connector**Digital input/output** USB 2.0 High-Speed**Microphone/
remote release connector** ϕ 2.5 mm mini-stereo jack**Power supply/other****Power supply** NP-W126 rechargeable battery

Battery life (approximate number of frames that can be taken with a fully-charged battery and XF 35 mm f/1.4 R lens)	Battery type	Approximate number of frames
		NP-W126 (type supplied with camera)

CIPA standard, measured using battery supplied with camera and SD memory card.

Note: Number of shots that can be taken with battery varies with battery charge level and will decline at low temperatures.

Camera size (W × H × D) 129.0 mm × 74.9 mm × 37.2 mm (30.9 mm excluding projections, measured at thinnest part)/5.0 in. × 2.9 in. × 1.4 in. (1.2 in.)**Camera weight** Approx. 300 g/10.5 oz., excluding battery, accessories, and memory card**Shooting weight** Approx. 350 g/12.3 oz., including battery and memory card**Operating conditions** • **Temperature:** 0°C to +40°C/+32°F to +104°F • **Humidity:** 10% – 80% (no condensation)**Wireless transmitter****Standards** IEEE 802.11b/g/n (standard wireless protocol)**Operating frequency** • **U. S. A., Canada, Taiwan:** 2,412 MHz–2,462 MHz (11 channels)
• **Other countries:** 2,412 MHz–2,472 MHz (13 channels)**Access protocols** Infrastructure

NP-W126 rechargeable battery

Nominal voltage	7.2V DC
Nominal capacity	1,260 mAh
Operating temperature	0°C to +40°C/+32°F to +104°F
Dimensions (W×H×D)	36.4 mm × 47.1 mm × 15.7 mm/1.4 in. × 1.8 in. × 0.6 in.
Weight	Approx. 47 g/1.7 oz.

BC-W126 battery charger

Rated input	100V – 240V AC, 50/60Hz
Input capacity	13 – 21 VA
Rated output	8.4V DC, 0.6 A
Supported batteries	NP-W126 rechargeable batteries
Charging time	Approx. 150 minutes (+20°C/+68°F)
Operating temperature	5°C to +40°C/+41°F to +104°F
Dimensions (W×H×D)	65 mm × 91.5 mm × 28 mm/2.5 in. × 3.6 in. × 1.1 in., excluding projections
Weight	Approx. 77 g/2.7 oz., excluding battery

Weight and dimensions vary with the country or region of sale. Labels, menus, and other displays may differ from those on the actual camera.

■ **Notices**

- Specifications subject to change without notice; for the latest information, visit http://www.fujifilm.com/products/digital_cameras/index.html. FUJIFILM shall not be held liable for damages resulting from errors in this manual.
- Although the viewfinder and LCD monitor are manufactured using advanced high-precision technology, small bright points and anomalous colors may appear, particularly in the vicinity of text. This is normal for this type of LCD display and does not indicate a malfunction; images recorded with the camera are unaffected.
- Digital cameras may malfunction when exposed to strong radio interference (e.g., electric fields, static electricity, or line noise).
- Due to the type of lens used, some distortion may occur at the periphery of images. This is normal.

Restrictions on Camera Settings

The options available in each shooting mode are listed below.















Option		P	S	A	M				
MACRO	OFF	✓	✓	✓	✓	✓	✓	✓	✓
		✓	✓	✓	✓	✓	✓	✓	
Focus mode	C	✓	✓	✓	✓	✓	✓	✓	✓
	S	✓	✓	✓	✓	✓	✓	✓	✓
	M	✓	✓	✓	✓	✓	✓	✓	✓
Exposure compensation		✓	✓	✓		✓	✓	✓	✓
ISO	H (25600)	✓	✓	✓	✓				
	H (12800)	✓	✓	✓	✓				
	6400	✓	✓	✓	✓	✓			
	5000	✓	✓	✓	✓	✓			
	4000	✓	✓	✓	✓	✓			
	3200	✓	✓	✓	✓	✓			
	2500	✓	✓	✓	✓	✓			
	2000	✓	✓	✓	✓	✓			
	1600	✓	✓	✓	✓	✓			
	1250	✓	✓	✓	✓	✓			
	1000	✓	✓	✓	✓	✓			
	800	✓	✓	✓	✓	✓	✓		
	640	✓	✓	✓	✓	✓	✓		
	500	✓	✓	✓	✓	✓	✓		
	400	✓	✓	✓	✓	✓	✓		
	320	✓	✓	✓	✓	✓	✓		
	250	✓	✓	✓	✓	✓	✓		
	200	✓	✓	✓	✓	✓	✓		
	L (100)	✓	✓	✓	✓	✓			
	AUTO	✓	✓	✓	✓	✓	✓		

Option		P	S	A	M				
IMAGE SIZE		✓	✓	✓	✓	✓	✓	✓	
		✓	✓	✓	✓	✓	✓	✓	
		✓	✓	✓	✓	✓		✓	
IMAGE QUALITY	FINE	✓	✓	✓	✓	✓	✓	✓	
	NORMAL	✓	✓	✓	✓	✓	✓	✓	
	FINE+RAW	✓	✓	✓	✓				
	NORMAL+RAW	✓	✓	✓	✓				
DYNAMIC RANGE	RAW	✓	✓	✓	✓			✓	✓
	AUTO	✓	✓	✓	✓		✓	✓	
		✓	✓	✓	✓	✓	✓	✓	
FILM SIMULATION		✓	✓	✓	✓	✓	✓		✓
		✓	✓	✓	✓	✓	✓		✓
		✓	✓	✓	✓	✓	✓		✓
FILM SIMULATION		✓	✓	✓	✓	✓	✓		✓
		✓	✓	✓	✓	✓	✓		✓
		✓	✓	✓	✓	✓	✓		✓
		✓	✓	✓	✓	✓	✓		✓
		✓	✓	✓	✓	✓	✓		✓
		✓	✓	✓	✓	✓	✓		✓
		✓	✓	✓	✓	✓	✓		✓
SELF-TIMER	✓	✓	✓	✓	✓		✓		
WHITE BALANCE	✓	✓	✓	✓	✓	✓		✓	
COLOR	✓	✓	✓	✓	✓				
SHARPNESS	✓	✓	✓	✓	✓				

Restrictions on Camera Settings

Option	P	S	A	M				
HIGHLIGHT TONE	✓	✓	✓	✓	✓			
SHADOW TONE	✓	✓	✓	✓	✓			
NOISE REDUCTION	✓	✓	✓	✓	✓			
LONG EXPOSURE NR	✓	✓	✓	✓	✓		✓	
LENS MODULATION OPTIMIZER	✓	✓	✓	✓	✓	✓	✓	
SELECT CUSTOM SETTING	✓	✓	✓	✓	✓			
EDIT/SAVE CUSTOM SETTING	✓	✓	✓	✓	✓			
DISP. CUSTOM SETTING	FRAMING GUIDELINE	✓	✓	✓	✓	✓		✓
	ELECTRONIC LEVEL	✓	✓	✓	✓	✓		✓
	AF DISTANCE INDICATOR	✓	✓	✓	✓	✓		✓
	MF DISTANCE INDICATOR	✓	✓	✓	✓	✓		
	HISTOGRAM	✓	✓	✓	✓	✓		✓
	APERTURE/S-SPEED/ISO	✓	✓	✓	✓	✓		✓
	EXP. COMPENSATION	✓	✓	✓	✓	✓		✓
	PHOTOMETRY	✓	✓	✓	✓	✓		
	FLASH	✓	✓	✓	✓	✓		✓
	WHITE BALANCE	✓	✓	✓	✓	✓		✓
	FILM SIMULATION	✓	✓	✓	✓	✓		✓
	DYNAMIC RANGE	✓	✓	✓	✓	✓		
	FRAMES REMAINING	✓	✓	✓	✓	✓		✓
	BATTERY LEVEL	✓	✓	✓	✓	✓		✓
	IMAGE SIZE/QUALITY	✓	✓	✓	✓	✓		✓

Option	P	S	A	M				
AF ILLUMINATOR	✓	✓	✓	✓	✓			✓
AF MODE		✓	✓	✓	✓	✓	✓	✓
		✓	✓	✓	✓	✓	✓	✓
FACE DETECTION	✓	✓	✓	✓	✓		✓	✓
FOCUS AREA	✓	✓	✓	✓	✓		✓	
PRE-AF	✓	✓	✓	✓	✓	✓	✓	
PHOTOMETRY		✓	✓	✓	✓	✓		✓
		✓	✓	✓	✓	✓		✓
		✓	✓	✓	✓	✓		✓
FLASH MODE	AUTO	✓				✓		✓
		✓	✓	✓	✓	✓		✓
	OFF	✓		✓		✓		✓
		✓	✓	✓	✓	✓		✓
		✓	✓	✓	✓	✓		✓
		✓	✓	✓	✓	✓		✓
		✓	✓	✓	✓	✓		✓
		✓	✓	✓	✓	✓		✓
		✓	✓	✓	✓	✓		✓
		✓	✓	✓	✓	✓		✓
FLASH COMPENSATION	✓	✓	✓	✓	✓		✓	
RED EYE REMOVAL	✓	✓	✓	✓	✓			
IS MODE	✓	✓	✓	✓	✓		✓	
APERTURE SETTING	✓		✓	✓	✓	✓	✓	
MF ASSIST	STANDARD	✓	✓	✓	✓	✓		✓
	DIGITAL SPLIT IMAGE	✓	✓	✓	✓			
	FOCUS PEAK HIGHLIGHT	✓	✓	✓	✓			✓

Option		P	S	A	M						
	MOVIE MODE										✓
	MIC LEVEL ADJUSTMENT										✓
	MIC/REMOTE RELEASE										✓
	SCREEN SET-UP										
	PREVIEW EXP. IN MANUAL MODE				✓	✓ ¹	✓ ¹	✓ ¹			
	 FOCUS CHECK	✓	✓	✓	✓	✓					✓
	FOCUS RING	✓	✓	✓	✓	✓	✓				✓
	POWER MANAGEMENT										
	AUTO POWER OFF	✓	✓	✓	✓	✓	✓	✓	✓	✓	✓
	HIGH PERFORMANCE	✓	✓	✓	✓	✓	✓	✓	✓	✓	✓
	COLOR SPACE	✓	✓	✓	✓	✓	✓	✓	✓	✓	✓ ⁵

- 1 Continuous AF is used when **S** is selected for focus mode.
- 2 Center focus area selected automatically.
- 3 Options available vary with shooting mode.
- 4 Manual exposure mode only.
- 5 sRGB selected automatically.

FUJIFILM

FUJIFILM Corporation

7-3, AKASAKA 9-CHOME, MINATO-KU, TOKYO 107-0052, JAPAN

http://www.fujifilm.com/products/digital_cameras/index.html