



▶▶ NEUMANN.BERLIN

▶ KH 310 ACTIVE STUDIO MONITOR

OPERATING MANUAL





Contents

Important safety instructions	2
The KH 310 studio monitor	4
Package contents	4
Product overview	5
Installing and connecting the KH 310	6
Preparing the loudspeakers	6
Preparing the room	7
Positioning the loudspeakers	7
Connecting the audio cables	9
Connecting/disconnecting the KH 310 to/from the mains power supply	10
Configuring and using the KH 310	11
Switching the KH 310 on/off	11
Adjusting the frequency response	11
Adjusting the acoustical level	12
Activating ground lift	13
Adjusting the brightness of the Neumann logo	13
Cleaning and maintaining the KH 310	14
Troubleshooting	14
Specifications	14
Manufacturer Declarations	17
Appendix	
System Block Diagram	I
Pin assignment of the XLR socket	I
Acoustical Measurements	I
Installation angles	III



Important safety instructions

1. Read these instructions.
2. Keep these instructions. Always include these instructions when passing the product on to third parties.
3. Heed all warnings.
4. Follow all instructions.
5. Do not use this apparatus near water.
6. Only clean the product when it is not connected to the mains power supply. Clean only with a dry cloth.
7. Always ensure a free air flow around the cooling fins on the rear of the product. Do not block any ventilation openings. Install in accordance with the manufacturer's instructions.
8. Do not install near any heat sources such as radiators, heat registers, stoves, or other apparatus (including amplifiers) that produce heat.
9. Do not defeat the safety purpose of the polarized or grounding-type plug. A polarized plug has two blades with one wider than the other. A grounding type plug has two blades and a third grounding prong. The wide blade or the third prong are provided for your safety. If the provided plug does not fit into your outlet, consult an electrician for replacement of the obsolete outlet.
10. Protect the power cord from being walked on or pinched, particularly at plugs, convenience receptacles, and the point where it exits from the apparatus.
11. Only use attachments/accessories specified by the manufacturer.
12. Use only with the cart, stand, tripod, bracket, or table specified by the manufacturer, or sold with the apparatus. When a cart is used, use caution when moving the cart/apparatus combination to avoid injury from tip-over. 
13. Unplug this apparatus during lightning storms or when unused for long periods of time.
14. Refer all servicing to qualified service personnel. Servicing is required when the apparatus has been damaged in any way, such as power supply cord or plug is damaged, liquid has been spilled or objects have fallen into the apparatus, when the apparatus has been exposed to rain or moisture, does not operate normally, or has been dropped.
15. To completely disconnect this apparatus from the AC mains, disconnect the power supply cord plug from the AC receptacle.
16. **WARNING:** To reduce the risk of fire or electric shock, do not expose this apparatus to rain or moisture.
17. Do not expose this equipment to dripping or splashing and ensure that no objects filled with liquids, such as vases, are placed on the equipment.
18. The mains plug of the power supply cord shall remain readily accessible.

- Installation**
- Ensure that the room in which you use this product is wired in accordance with the local electrical code and checked by a qualified inspector.
 - Only use the product indoors.
 - Do not install the product in hot, humid, or excessively dusty locations, in direct sunlight or in locations where it is exposed to externally generated vibrations.
 - Do not place burning objects (e.g. candles) on top of or near the product.
 - If condensation has formed on the product, e.g. because it was moved from a cold environment to a warm one, allow the product to acclimatize to room temperature before using it.
 - Do not overload wall outlets and extension cables as this may result in fire and electric shock.



Danger due to high sound pressure levels



WARNING

Danger of hearing damage due to sudden high sound pressure levels!

Audio signals that are present at switch-on of the product or that can be present during operation, can create sudden, very high sound pressure levels which can damage your hearing.

- ▶ Always lower the output level of the audio source **before** connecting it to the loudspeaker or starting it (pressing “play”).

This loudspeaker can be used for commercial purposes. Commercial use is subject to the rules and regulations of the trade association responsible. Neumann, as the manufacturer, is therefore obliged to expressly point out possible health risks arising from use. This loudspeaker is capable of producing sound pressure levels exceeding 85 dB(A) SPL. This is the sound pressure corresponding to the maximum permissible level which is by law (in some countries) allowed to affect your hearing for the duration of a working day (8 hours). It is used as a basis according to the specifications of industrial medicine. Higher sound pressure levels and/or longer durations can damage your hearing. At higher sound pressure levels, the duration must be shortened in order to prevent hearing damage. The following are signs that you have been subjected to excessive sound pressure levels for too long a time:

- You can hear ringing or whistling sounds in your ears.
- You have the impression (even for a short time only) that you can no longer hear high frequencies (temporary threshold shift).

Magnetic fields



WARNING

Interference due to magnetic fields!

This product generates a permanent magnetic field (> 1.5 mT) that can interfere with cardiac pacemakers and implanted defibrillators (ICDs).

- ▶ Always maintain a distance of at least 10 cm (4") between the loudspeaker and the cardiac pacemaker or implanted defibrillator.

Hazard warnings on the rear of the product

The label shown on the right is attached to the rear of the product.



The symbols on this label have the following meaning:

Presence of uninsulated dangerous voltage within the product’s enclosure that may be of sufficient magnitude to constitute a risk of fire or electric shock.

Never open the product or remove the grilles fitted to the product as there is a risk of electric shock. There are no user serviceable parts inside. Refer servicing to your Neumann service partner.

Read and follow the safety and operating instructions contained in the operating manual.



Intended use

Intended use of the product includes:

- having read this operating manual, especially the chapter “Important safety instructions”,
- using the product within the operating conditions and limitations described in this operating manual.

“Improper use” means using the product other than as described in this operating manual, or under operating conditions which differ from those described herein.



The KH 310 studio monitor

Thank you for purchasing a Neumann studio monitor. The KH 310 features a Mathematically Modeled Dispersion™ Waveguide (MMD™), flexible acoustical controls, various input options and an extensive range of mounting hardware. This allows the loudspeaker to be used in diverse acoustical conditions, with any source equipment and in a wide variety of physical locations. The KH 310 represents the latest in acoustic and electronic simulation and measurement technologies to ensure the most accurate sound reproduction possible.

Depending on the size, Neumann's three-way loudspeaker systems are designed for use as near-field monitors, as front loudspeakers in mid-sized multi-channel systems, or as rear loudspeakers in larger multi-channel systems. They can be used in project, music, broadcast centers, OB vans, and post production studios for tracking, mixing, and mastering.

Package contents

- 1 KH 310 A "left" or KH 310 A "right"
- 3 Mains cables (European, UK and US versions)
- 4 Self-adhesive feet
- 1 Operating manual
- 1 "Getting Started Quickly" supplement



Note that imperial dimensions are approximate.



The current operating manual, the supplement "Getting Started Quickly" and further information can be downloaded from the "Downloads" area on the product page at www.neumann.com.



Product overview

i The KH 310 comes in two variants named “left” and “right” (see figure). It is also possible to use a “left” in the “right” position, and vice versa. Both variants can also be used as a center loudspeaker. Information about positioning your KH 310 can be found on page 7.

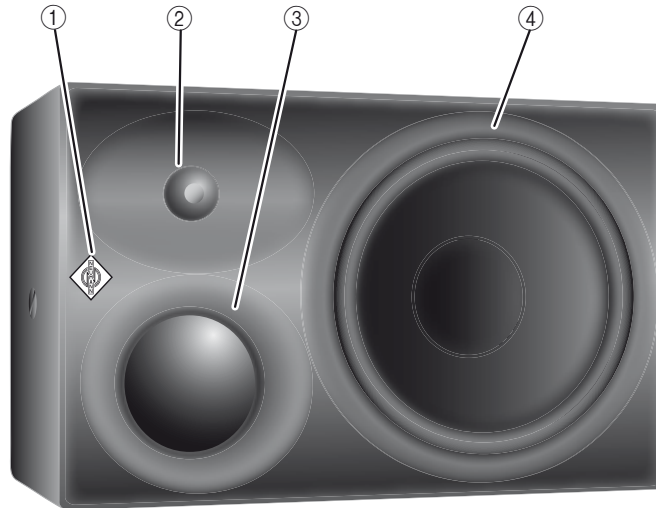

- ① Neumann logo
 - lights up white: loudspeaker is switched on and ready for operation
 - flashes red: loudspeaker’s protection system is active
 - lights up red: electronic’s temperature is too high
 - output level is reduced
- ② Treble driver
- ③ Midrange driver
- ④ Bass driver

i You can adjust the brightness of the Neumann logo. For more information, refer to page 13.

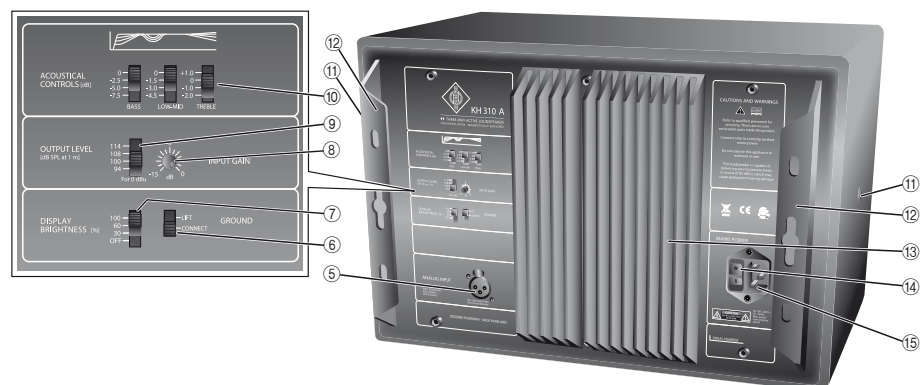

- ⑤ ANALOG INPUT socket (XLR)
- ⑥ GROUND switch (Connects/disconnects ground)
- ⑦ DISPLAY BRIGHTNESS switch (Dims the Neumann logo)
- ⑧ INPUT GAIN control
- ⑨ OUTPUT LEVEL switch
- ⑩ ACOUSTICAL CONTROL switches
- ⑪ Holes for Neumann mounting hardware
- ⑫ Handles with mounting holes
- ⑬ Cooling fins
- ⑭ On/off switch I/O
- ⑮ IEC mains socket



Installing and connecting the KH 310



CAUTION

Danger of injury and material damage due to tipping/dropping of the product!

If improperly mounted, the product and/or the mounting hardware (e.g. rack) can tip over or drop down.

- ▶ Always have the product mounted by a qualified specialist according to local, national and international regulations and standards.
- ▶ Use the mounting systems recommended by Neumann and always provide sufficient additional protection against tipping or dropping!

CAUTION

Damage to the product due to overheating!

If air cannot circulate properly around the cooling fins on the rear of the product, the amplifier(s) may overheat leading to premature activation of the thermal protection system which limits the maximum output level of the loudspeaker. In rare cases, damage to the product may also occur.

- ▶ Never cover the cooling fins.
- ▶ When installing the product into tight spaces such as wall recesses, maintain an air gap of at least 5 cm (2") around the rear of the product and provide sufficient air circulation. If necessary, use forced-air cooling (e.g. in OB vans).



It is not possible to remove the electronics panel and locate it remotely.



For information on installation, please refer to the supplied "Getting Started Quickly" supplement. This will help you set up the loudspeakers in a way that will give you the best acoustic performance from the system.

For further information on setting up loudspeakers, please refer to the "Questions & Answers" section on the product page at www.neumann.com.

For more information on building systems using Neumann loudspeaker products, please refer to the "Product Selection Guide" at www.neumann.com

Preparing the loudspeakers

CAUTION

Risk of staining surfaces!

Some surfaces treated with varnish, polish or synthetics may suffer from stains when they come into contact with other synthetics. Despite a thorough testing of the synthetics used, we cannot rule out the possibility of staining.

- ▶ Do not place the KH 310 on delicate surfaces.



CAUTION

Danger of damaging the midrange and bass drivers!

If the KH 310 is placed face down on a soft surface or if the front panel of the KH 310 is pressed against your body when you carry it, the drivers can be damaged.

- ▶ Never place the KH 310 on a soft surface with the front panel facing downwards.
- ▶ Always carry the KH 310 so that the front panel is facing upwards.



You can use the handles ⑫ on the rear panel to lift the loudspeaker.

To place the loudspeaker on a flat surface:

- ▶ Attach the supplied self-adhesive feet to the bottom of the cabinet.
This reduces the risk of scratching the surface and acoustically isolates the loudspeaker from the surface.



Preparing the room

- ▶ Arrange all acoustically relevant surfaces and objects symmetrically on either side of the listening axis of the room (left/right).
- ▶ Minimize the sound that is reflected back to the listening position by using angled surfaces and/or acoustical treatment.

i This product has been optimized for use in recording studios. In order to not affect the quality of reproduction, make sure that the product is used in an EMC environment.

Positioning the loudspeakers

- ▶ Carry out the following steps very accurately, since the more accurate the physical arrangement of the loudspeakers in the room, the more accurate the reproduction will be at the listening position.

- Distances**
- ▶ Observe the recommended distances between the loudspeakers and your listening position (imperial dimensions are approximate):
 - Minimum: 0.75 m (2' 6")
 - Recommended: 1.0–2.5 m (3'–8')
 - Maximum: 6.0 m (18')

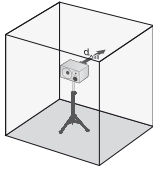

- ▶ Avoid positioning the loudspeaker at a distance " d_{wall} " of 0.8 to 2 m (2' 6" to 6') from the wall behind the loudspeaker.

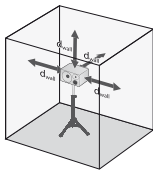

When positioning bass managed loudspeakers:

- ▶ Avoid a distance " d_{wall} " of 0.8 to 1 m (2' 6" to 3') from a solid wall behind the loudspeaker. Similarly, avoid these distances from solid side walls or a solid ceiling. Respecting these positioning limitations reduces the chances of dips and peaks in the low frequency response (comb filtering) caused by strong reflections.

Positioning the KH 310

The KH 310 comes in two variants named "left" and "right".

- ▶ Position the two variants at the same height and so that the bass drivers are on the inside.

If you are building a multichannel system:

- ▶ Use either a "left" or "right" variant for the center loudspeaker. Line up the acoustical axis along the center line of the loudspeaker array (see below).

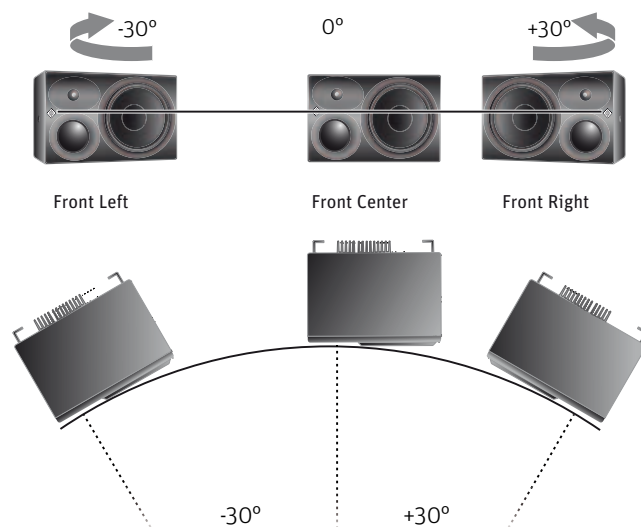

Arranging the loudspeakers

- ▶ Copy the diagram “Installation angles” that can be found at the end of this operating manual.
- ▶ Place the diagram at the listening position or center of the listening area.
- ▶ Using a tape measure or a cable, place the loudspeakers at the same distance from the center of the diagram “Installation angles”. To ensure good imaging, do this at an accuracy of at least 1 cm ($\frac{1}{2}$ ").
- ▶ Make sure that the distances are equal:

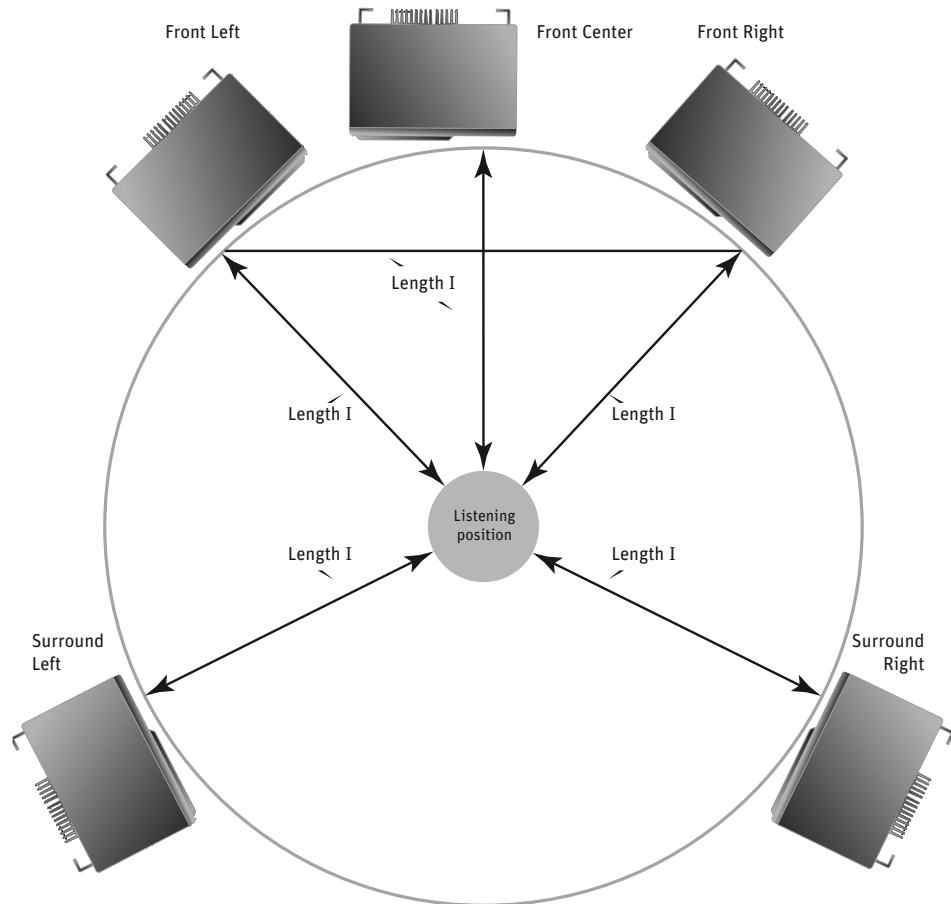

If the loudspeakers cannot be placed at the same distance from the listening position:

- ▶ Compensate for distance differences > 1 cm ($\frac{1}{2}$ ") by delaying closer loudspeakers by 30 μ s/cm (76 μ s/inch).
- ▶ At the same time, check the location of the loudspeaker cabinet. This depends on the application:
 - 2.0 systems (stereo): $\pm 30^\circ$, plus optional subwoofer(s)
 - 5.1 systems:
 - ITU-R BS.775-1: $0^\circ, \pm 30^\circ, \pm 110^\circ (\pm 10^\circ)$, plus optional subwoofer(s)
(center, front left/right, surround left/right)
 - ANSI/SMPTE 202M: $0^\circ, \pm 22.5^\circ$, arrays to the surround left and to the surround right, plus optional subwoofer(s)
 - 7.1 systems: $0^\circ, \pm 30^\circ, \pm 90^\circ, \pm 150^\circ$, plus optional subwoofer(s)
(center, front left/right, side left/right, back left/right)

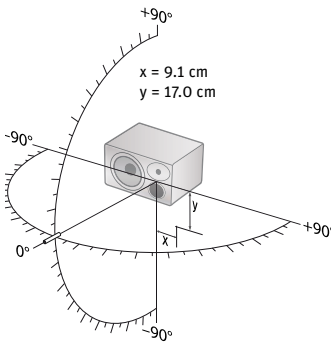

The acoustical axis of the KH 310 starts from the midpoint of the midrange and tweeter drivers.

- ▶ Always point the acoustical axis, in the horizontal and vertical planes, towards the listening position.

i The acoustical axis is a line perpendicular to the loudspeaker's front panel along which the microphone was placed when tuning the loudspeaker's crossover during design. Pointing the acoustical axis, in the horizontal and vertical planes, towards the listening position or center of the monitoring area will give the best measured and perceived sound quality.



- ▶ Position the loudspeaker so that there is a direct line of sight from the listening position to the bass, midrange and tweeter drivers.

Connecting the audio cables

Connecting analog cables

Connecting XLR cables

- ▶ Connect the output sockets of your audio source to the XLR input sockets of the loudspeakers.

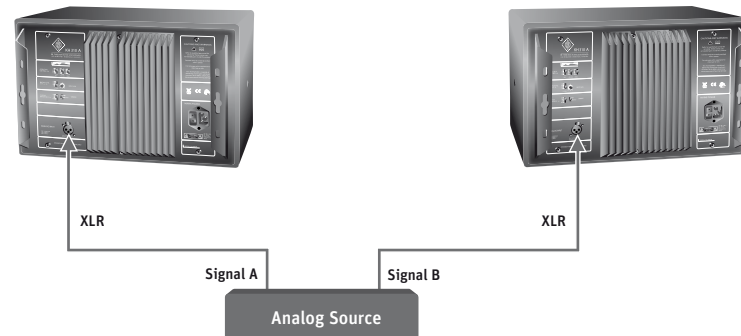

Connecting unbalanced cables

- ▶ Use an RCA-XLR adapter (not supplied) to connect unbalanced cables (e.g. RCA cables).
- ▶ Use the following wiring if you want to make your own RCA-XLR adapter:

Wiring	Pin	Signal
	1	Audio ground
	2	Signal +
	3	Signal -



Connecting/disconnecting the KH 310 to/from the mains power supply

To connect the KH 310 to the mains power supply:

- ▶ Make sure that the on/off switch ⑭ is set to “0”.
- ▶ Connect the IEC connector of the supplied mains cable to the mains socket ⑮.

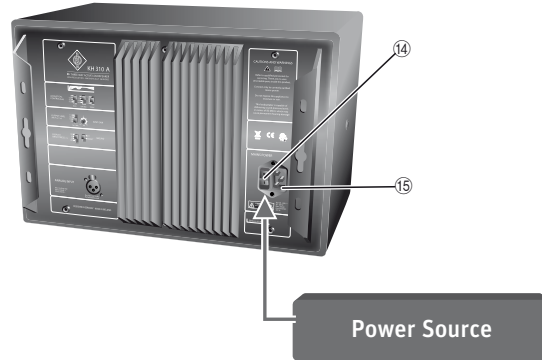

- ▶ Connect the mains plug of the mains cable to a suitable wall socket.

To disconnect the KH 310 from the mains power supply:

- ▶ Set the on/off switch ⑭ to “0”.
- ▶ Pull the mains plug out of the wall socket.



Configuring and using the KH 310

Switching the KH 310 on/off



▶ Set the on/off switch to:

- “I” to switch on the loudspeaker. The Neumann logo lights up, provided that it has not been switched off by means of the DISPLAY BRIGHTNESS switch ⑦ (see page 13).
- “O” to switch off the loudspeaker. The Neumann logo goes off.

i There is an approximate five second delay before sound can be heard from the loudspeaker in order to avoid noises (pops) from preceding equipment switched on at the same time. Conversely, switching off the loudspeaker immediately mutes the audio.

Adjusting the frequency response

When all its acoustical controls are set to 0 dB, the KH 310 loudspeaker is designed to have a flat frequency response in anechoic conditions. When the loudspeaker is installed in your monitoring environment, the response changes.

In addition, the frequency response of a loudspeaker depends on its position in the room. The same loudspeaker installed in different positions in the same room may require different acoustical control settings. In a symmetrical installation, left/right pairs (front or back) will probably have the same acoustical control settings.

- ▶ Before using your loudspeaker system for the first time, calibrate the frequency response of the loudspeakers in the room in order to obtain the desired response.
- ▶ Repeat the above step if you change the physical conditions in your studio.
- ▶ At your listening position, determine the frequency response of each loudspeaker.

▶ Use the acoustical controls to adjust the frequency response. Recommended frequency responses measured at the listening position:

- Studio applications: flat
- Film applications: X-curve shape (see ANSI/SMPTE 202M)
- Home applications: subjective evaluation

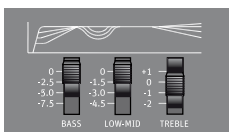



Acoustical control	Function	Possible settings
Bass	Compensates for acoustical loading in the low frequency range due to nearby large solid boundaries (e.g. walls).	0, -2.5, -5, -7.5 dB
Low-Mid	Compensates for acoustical loading in the low-mid frequency range due to nearby large solid objects (e.g. mixing consoles or desks).	0, -1.5, -3, -4.5 dB
Treble	Compensates for insufficient or excessive high-frequency damping in the room.	+1, 0, -1, -2 dB

The following settings can be used as a starting point for further adjustment:

Loudspeaker position	Acoustical controls		
	Bass	Low-Mid	Treble
In a corner	-7.5 dB	-1.5 dB	-
Next to an acoustically solid wall (e.g. brick, concrete)	-5 dB	-	-
Next to an acoustically soft wall (e.g. gypsum)	-2.5 dB	-	-
Free standing in an untreated room	-2.5 dB	-	-1 dB
Free standing in a well-treated room	-	-	-
In a small room with strong side wall reflections	-5 dB	0 dB	-
Near a small desktop or small reflecting surface*	-	-1.5 dB	-
Near a large desktop or large reflecting surface*	-	-3 dB	-

* Use these settings in addition to one of the top settings

Adjusting the acoustical level



- On your KH 310 loudspeakers, set the OUTPUT LEVEL switch to the lowest possible value of 94 dB SPL and the INPUT GAIN control to -15 dB.
- Play a broadband pink noise test signal that is set to -18 dBFS (Europe) or -20 dBFS (USA) on the mixing console's output level meters.
- Measure the sound pressure level at the listening position using a sound level meter with the following settings:
 - "C"-weighted
 - slow integration time
- Set the output level switch and the input gain control of your loudspeakers so that the desired acoustic level is obtained.

Recommended sound pressure levels:

Application	Sound pressure level
Film	85 dB(C)
Broadcast	79 to 83 dB(C)
Music	No defined reference levels

If the Neumann logo flashes red, the KH 310's protection system has been activated. To avoid this and achieve the desired output level, use larger loudspeakers or add a bass managed subwoofer to the system.



Examples of sound pressure levels as a function of the input and output level of the KH 310:

Input signal dBu	0 (0.775 V)	0 (0.775 V)	+4 (1.23 V)	-20 (77.5 mV)
Input gain KH 310 dB	0	-15	-4	-15
Output level KH 310 dB SPL	100	100	94	114
Sound pressure level dB SPL at 1 m	100	85	94	79

Activating ground lift



To avoid unwanted hum or buzz associated with the input signal cables or source equipment, you can internally disconnect pin 1 of the XLR socket from the loudspeaker electronics' chassis ground (see table on page 9):

- ▶ Set the GROUND switch ⑥ to "LIFT".

i For safety reasons, the electronics chassis ground is always connected to the mains power earth pin.

Adjusting the brightness of the Neumann logo

WARNING
Danger of hearing damage due to unexpected high sound pressure levels!

If the Neumann logo is switched off, it is not obvious whether the product is switched on or off. In this case, unexpected high sound pressure levels can cause hearing damage.

- ▶ Always set the audio sources connected to the loudspeaker to a low output level before they deliver an audio signal.
- ▶ If you switch off or dim the Neumann logo, mention this to everyone who works with this loudspeaker or the connected audio sources.



To dim or switch off the Neumann logo in low light level environments or when the loudspeaker is placed behind an acoustically transparent screen:

- ▶ Set the DISPLAY BRIGHTNESS switch ⑦ to:
 - "30 %", "60 %" or "100 %" to adjust the Neumann logo to different brightness levels.
 - "OFF" to switch off the Neumann logo.

i When the loudspeaker's protection system is active, the color of the Neumann logo changes from white to red. The brightness of this red limiter indication corresponds to the setting of the DISPLAY BRIGHTNESS switch ⑦ ("30 %", "60 %" or "100 %"). However, you cannot completely switch off the limiter indication, as it appears with a brightness of 30 % even if the DISPLAY BRIGHTNESS switch ⑦ is set to "OFF".



Cleaning and maintaining the KH 310

CAUTION

Damage to the product caused by liquids!

Liquids entering the product can cause a short-circuit in the electronics and damage or even destroy the product.

▶ Keep all liquids away from the product!

- ▶ Before cleaning, disconnect the product from the mains power supply.
- ▶ Use a soft, dry, and lint-free cloth to clean the product. Do not use any solvents or cleaning agents.
- ▶ Clean the cooling fins regularly. They should always be kept free from dust.
- ▶ Never touch the driver diaphragms.

Troubleshooting

Problem	Cause	Solution
The Neumann logo is off, no sound is heard from the KH 310	The KH 310's internal main fuse has blown.	Have the product checked by an authorized Neumann service partner.
The Neumann logo is off or not clearly visible, but sound is heard from the KH 310	The Neumann logo is switched off or dimmed.	Switch on the Neumann logo and switch off the dimming (see page 13) .
There is hum or buzz coming from the KH 310 when the audio cable is connected.	Bad cabling or ground loop in the installation.	Check all cabling to eliminate the cause of the problem, change from unbalanced to balanced cabling, or use the ground lift switch (see page 13).



For further information, please refer to the "Questions & Answers" section on the product page at www.neumann.com

Specifications

Acoustics	
Free field frequency response	34 Hz to 21 kHz ±3 dB
Pass band free field frequency response	36 Hz to 20 kHz ±2 dB
Self-generated noise (INPUT GAIN set to 0 dB, OUTPUT LEVEL set to 100 dB SPL)	< 20 dB(A) at 10 cm
Total harmonic distortion < 0.5 % at 95 dB SPL at 1 m	> 85 Hz
Max. SPL in full space / calc. in half space at 3 % THD at 1 m, averaged between 100 Hz and 6 kHz	114.2 dB SPL / 120.2 dB SPL
Bass capability: Max. SPL in half space at 3 % THD at 1 m, averaged between 50 Hz and 100 Hz	111.3 dB SPL



Max. short term SPL with IEC-weighted noise (IEC 60268-5) at 1 m, in typical listening conditions	113 dB(C) SPL
Max. short term SPL with music material at 2.3 m, in typical listening conditions (pair)	100 dB(C) SPL (full range) 107 dB(C) SPL (with subwoofer)
Max. long term SPL with pink noise at 2.3 m, in typical listening conditions (single/pair)	93/99 dB(C) SPL (full range) 94/100 dB(C) SPL (with subwoofer)
Electronics	
Woofer Class AB amplifier, continuous (peak) output power	150 W (210 W), THD and noise <0.1% with deactivated limiter
Midrange Class AB amplifier, continuous (peak) output power	70 W (90 W), THD and noise <0.1% with deactivated limiter
Tweeter Class AB amplifier, continuous (peak) output power	70 W (90 W), THD and noise <0.1% with deactivated limiter
Controller design	analog, active
Crossover frequencies; crossover slope	650 Hz, 2.0 kHz; 24 dB/oct., 4 th order
Acoustical controls	Bass: 0, -2.5, -5, -7.5 dB Low-mid: 0, -1.5, -3, -4.5 dB Treble: +1, 0, -1, -2 dB
Protection circuitry	Excursion limiter: Low Peak limiter: Low Thermo limiter: Low, Mid, High Overheat protection: Amplifiers
Infrasonic filter frequency; slope	15 Hz; 6 dB/oct.
Analog input	
Input type	XLR, electronically balanced
Impedance	depending on the position of the OUTPUT LEVEL switch: 114 dB SPL 20 kΩ 108 dB SPL 10 kΩ 100 dB SPL 20 kΩ 94 dB SPL 10 kΩ
Input gain control (sensitivity)	0 dB to -15 dB
Output level control	94, 100, 108, 114 dB SPL
CMRR	> 56 dB, 100 Hz to 15 kHz
Maximum input level	24 dBu
Product properties	
Power consumption (idle)	24 W
Power consumption (full output AC)	300 W
Dimensions (H x W x D)	253 x 383 x 292 mm (10" x 15 ¹ / ₈ " x 11 ¹ / ₂ "
Internal net volume/external volume	16.2 l/28.3 l
Weight	13.0 kg (28 lbs 11 oz)
Drivers bass, midrange, treble	magnetically shielded 210 mm (8 ¹ / ₄ "), 75 mm (3"), 25 mm (1")



Mounting points	2 x M8 thread on side panel, depth 25 mm (1"), Rear panel screws for attaching the LH 41 base plate Mounting holes in the handles
Cabinet surface finish, Color	Painted wood and polyurethane, Anthracite (RAL 7021). Rear panel: Aluminium, black anodized.
Operating conditions	
Ambient temperature	+10°C to +40°C (+50°F to +104°F)
Relative humidity	max. 90% (non-condensing)
Power supply	100 to 240 V~, 50/60 Hz
Transport/storage conditions	
Ambient temperature	-25°C to +70°C (-13°F to +158°F)
Relative humidity	max. 90%
In compliance with	
Europe CE	EMC: EN 55103-1/-2 Safety: EN 60065
USA	47 CFR 15 subpart B
Canada	ICES-003

Acoustical measurements, block diagram and pin assignment

Additional technical data such as acoustical measurements, a block diagram of the KH 310 and the pin assignment of the XLR socket can be found at the end of this operating manual.

Accessories

Product	Description
BKH 310	Soft carry bag for one KH 310
FKH 310	Flight case for one KH 310
GKH 310	Metal grille
LH 25	Mounting bracket
LH 28	Tripod stand adapter
LH 29	TV spigot (lighting stand adapter)
LH 36	Tilting adapter
LH 37	Subwoofer adapter
LH 41	Base plate
LH 43	Surface mounting plate
LH 45	Wall bracket
LH 46	Adjustable ceiling drop adapter
LH 47	Mounting adapter plate
LH 48	Tripod adapter plate



Manufacturer Declarations

Guarantee

For the current terms and conditions of the product guarantee, please visit www.neumann.com.

In compliance with the following requirements



- WEEE (2002/96/EC)

Please dispose of the product at the end of its operational lifetime by taking it to your local collection point or recycling center for such equipment.

CE Declaration of Conformity



- RoHS (2011/65/EU)
- Low Voltage Directive (2006/95/EC)
- EMC Directive (2004/108/EC)

The declarations are available on the product page at www.neumann.com.

Certified by



Audio, Video and Similar Electronic Apparatus - Safety Requirements CAN/CSA-C22.2 No. 60065:03 and UL 60065-2007

Trademarks

Neumann® is a registered trademark of Georg Neumann GmbH. The following are trademarks of Georg Neumann GmbH:

- “Mathematically Modeled Dispersion” and “MMD”

Other company, product, or service names mentioned in this operating manual may be the trademarks, service marks, or registered trademarks of their respective owners.

FCC

This device complies with Part 15 of the FCC Rules. Operation is subject to the following two conditions: (1) this device may not cause harmful interference, and (2) this device must accept any interference received, including interference that may cause undesired operation.

This class B digital apparatus complies with the Canadian ICES-003.

Changes or modifications made to this equipment not expressly approved by Neumann may void the FCC authorization to operate this equipment.



System Block Diagram/System-Blockdiagramm/ Synoptique Système/Diagrama de Bloques del Sistema

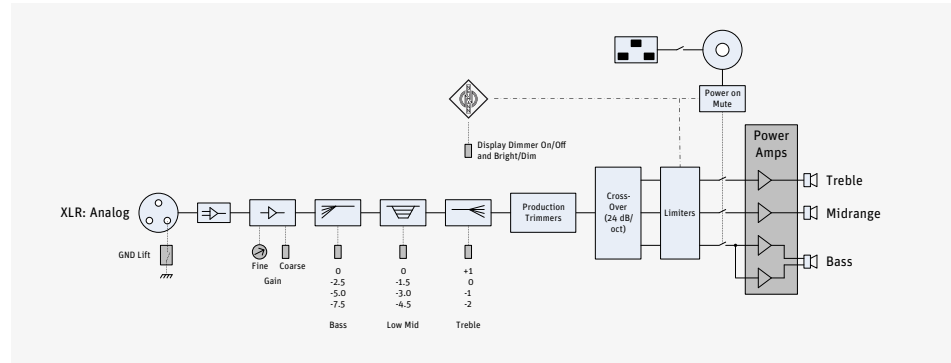

Pin assignment of the XLR socket/Buchsenbelegung XLR/ Brochage de la prise XLR/Asignación de la hembra XLR

1	Audio ground/Audio-Erdung/Masse audio/Toma de tierra de audio	
2	Signal +/Signal +/Signal +/Señal +	
3	Signal -/Signal -/Signal -/Señal -	

Acoustical Measurements/Akustische Messungen/ Mesures acoustiques/Mediciones Acústicas

EN	Below are acoustical measurements conducted in anechoic conditions at 1 m. Color versions of these graphs can be found on the appropriate product page of the web site.
DE	Die folgenden akustischen Messungen wurden unter reflexionsarmen Bedingungen bei 1 m Abstand durchgeführt. Farbversionen dieser Diagramme finden Sie auf den entsprechenden Produktseiten der Neumann-Website.
FR	Vous trouverez ci après les courbes correspondant aux mesures acoustiques effectuées en chambre sourde, à une distance de 1 mètre du moniteur. Vous retrouverez ces courbes, en couleur, dans la section appropriée de notre site Web.
ES	Las siguientes mediciones acústicas se han realizado bajo condiciones de baja reflexión a una distancia de 1 m. Encontrará versiones a color de estos diagramas en las páginas correspondientes de los productos en la página web de Neumann.

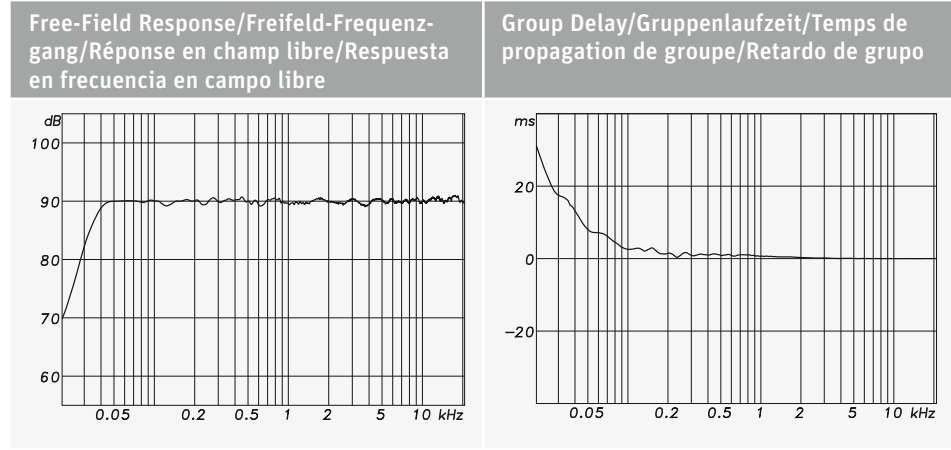

- EN
- DE
- FR
- ES



Harmonic Distortion at 90 dB SPL/
Klirrfaktor bei 90 dB SPL/
Distorsion harmonique à 90 dB SPL/
Distorsión armónica total a 90 dB SPL

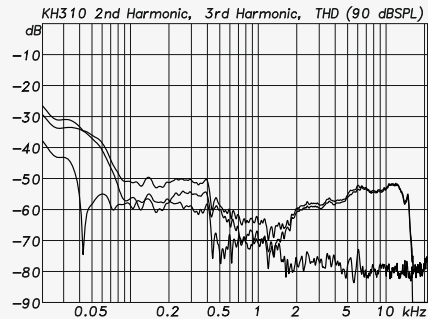

Harmonic Distortion at 95 dB SPL/
Klirrfaktor bei 95 dB SPL/
Distorsion harmonique à 95 dB SPL/
Distorsión armónica total a 95 dB SPL

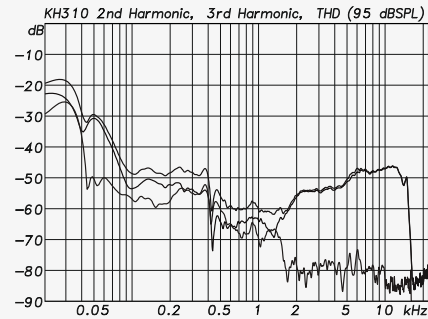

Maximum SPL at 1 m (1 % and 3 %)/
Maximaler SPL bei 1 m (1 % und 3 %)/
Niveau SPL maximal, à 1 m (1 % et 3 %)/
SPL máximo a 1 m (1 % y 3 %)

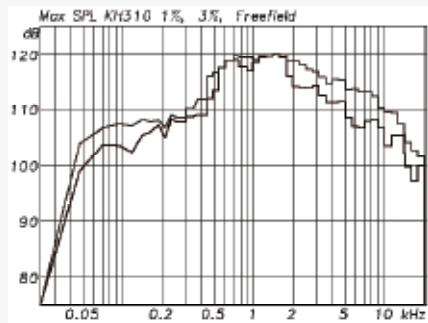

Acoustical Controls/Akustikregler/
Effet des correcteurs de compensation
acoustiques/Regulador acústico

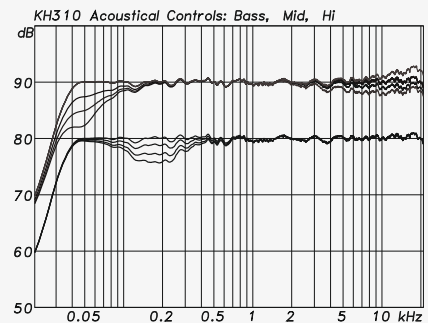

Cumulative Spectral Decay/Zerfalls-
spektrum/Waterfall (Decay spectral)/
Caída espectral acumulada

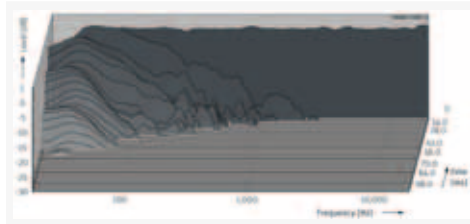

Horizontal Directivity Plot/Horizontales
Abstrahlverhalten/Directivité horizontale/
Directividad horizontal

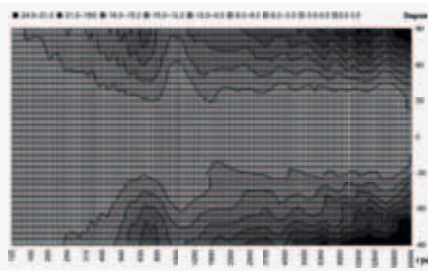

Vertical Directivity Plot/Vertikales
Abstrahlverhalten/Directivité verticale/
Directividad vertical

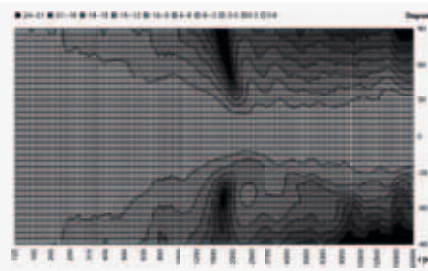

EN

DE

FR

ES



Installation angles/Aufstellwinkel/Angles d'installation/ Ángulos de colocación

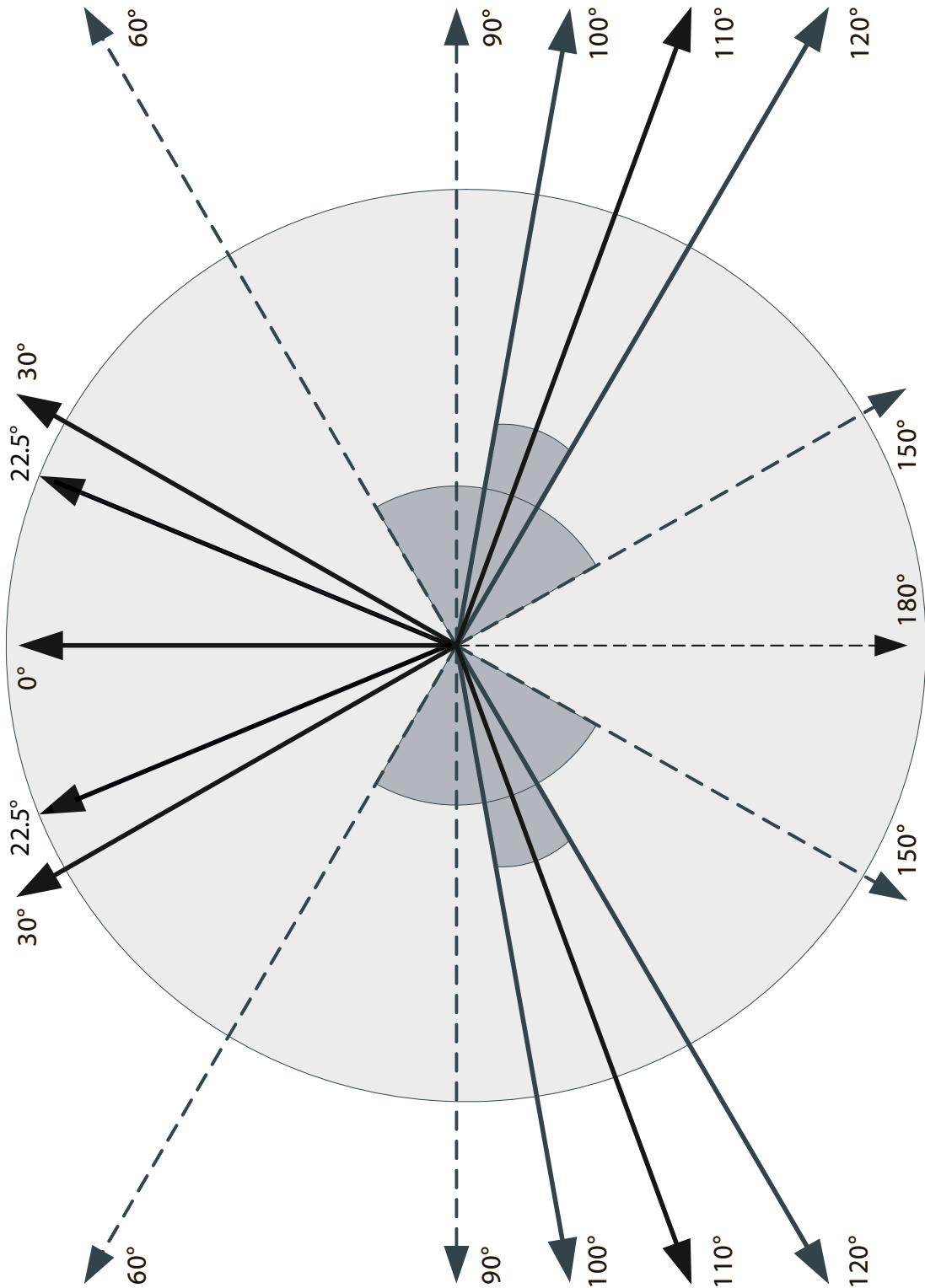

EN

DE

FR

ES

