

Operating Instructions Functional Manual

DLP™ Projector Commercial Use

Model No. **PT-DZ13KE**
PT-DS12KE
PT-DW11KE
PT-DZ10KE

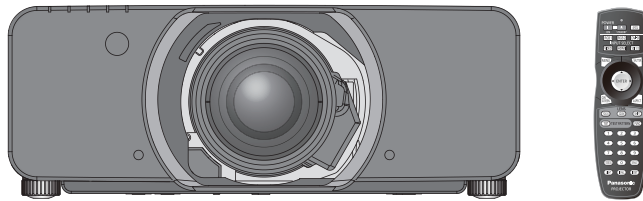

The projection lens is sold separately.

Thank you for purchasing this Panasonic product.

- The Operating Instructions correspond to the firmware's main version 4.00 and higher.
- Before operating this product, please read the instructions carefully and save this manual for future use.
- Before using your projector, be sure to read "Read this first!" (➔ pages 2 to 9).

real D 3D

Read this first!

WARNING: THIS APPARATUS MUST BE EARTHED.

WARNING: To prevent damage which may result in fire or shock hazard, do not expose this appliance to rain or moisture.
This device is not intended for use in the direct field of view at visual display workplaces. To avoid incommoding reflexions at visual display workplaces this device must not be placed in the direct field of view.
The equipment is not intended for used at a video workstation in compliance BildscharbV.

The sound pressure level at the operator position is equal or less than 70 dB (A) according to ISO 7779.

WARNING:

1. Remove the plug from the mains socket when this unit is not in use for a prolonged period of time.
2. To prevent electric shock, do not remove cover. No user serviceable parts inside. Refer servicing to qualified service personnel.
3. Do not remove the earthing pin on the mains plug. This apparatus is equipped with a three prong earthingtype mains plug. This plug will only fit an earthing-type mains socket. This is a safety feature. If you are unable to insert the plug into the mains socket, contact an electrician. Do not defeat the purpose of the earthing plug.

WARNING:

This is a class A product. In a domestic environment this product may cause radio interference in which case the user may be required to take adequate measures.

CAUTION: To assure continued compliance, follow the attached installation instructions, which include using the provided power cord and shielded interface cables when connecting to computer or peripheral device. If you use serial port to connect PC for external control of projector, you must use a commercial RS-232C serial interface cable with ferrite core. Any unauthorized changes or modifications to this equipment will void the user's authority to operate.

This is a device to project images onto a screen, etc., and is not intended for use as indoor lighting in a domestic environment.

Directive 2009/125/EC

Importer's name and address within the European Union

Panasonic Marketing Europe GmbH

Panasonic Testing Center

Winsbergring 15, 22525 Hamburg, Germany

Product information (for Turkey only)

EEE Yönetmeliğine Uygundur.

EEE Complies with Directive of Turkey.

IMPORTANT: THE MOULDED PLUG (U.K. only)

FOR YOUR SAFETY, PLEASE READ THE FOLLOWING TEXT CAREFULLY.

This appliance is supplied with a moulded three pin mains plug for your safety and convenience. A 13 amp fuse is fitted in this plug. Should the fuse need to be replaced, please ensure that the replacement fuse has a rating of 13 amps and that it is approved by ASTA or BSI to BS1362.

Check for the ASTA mark  or the BSI mark  on the body of the fuse.

If the plug contains a removable fuse cover, you must ensure that it is refitted when the fuse is replaced. If you lose the fuse cover, the plug must not be used until a replacement cover is obtained. A replacement fuse cover can be purchased from an Authorised Service Center.

If the fitted moulded plug is unsuitable for the mains socket in your home, then the fuse should be removed and the plug cut off and disposed of safely. There is a danger of severe electrical shock if the cut off plug is inserted into any 13 amp socket.

If a new plug is to be fitted, please observe the wiring code as shown below.
If in any doubt, please consult a qualified electrician.

WARNING: THIS APPLIANCE MUST BE EARTHED.

IMPORTANT: The wires in this mains lead are coloured in accordance with the following code:

Green - and - Yellow: Earth
Blue: Neutral
Brown: Live

As the colours of the wire in the mains lead of this appliance may not correspond with the coloured markings identifying the terminals in your plug, proceed as follows.

The wire which is coloured GREEN - AND - YELLOW must be connected to the terminal in the plug which is marked with the letter E or by the Earth symbol  or coloured GREEN or GREEN - AND - YELLOW.

The wire which is coloured BLUE must be connected to the terminal in the plug which is marked with the letter N or coloured BLACK.

The wire which is coloured BROWN must be connected to the terminal in the plug which is marked with the letter L or coloured RED.

How to replace the fuse: Open the fuse compartment with a screwdriver and replace the fuse.

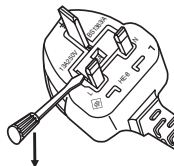

WARNING:

■ **POWER**

The wall outlet or the circuit breaker shall be installed near the equipment and shall be easily accessible when problems occur. If the following problems occur, cut off the power supply immediately.

Continued use of the projector in these conditions will result in fire or electric shock.

- If foreign objects or water get inside the projector, cut off the power supply.
- If the projector is dropped or the cabinet is broken, cut off the power supply.
- If you notice smoke, strange smells or noise coming from the projector, cut off the power supply.

Please contact an Authorized Service Center for repairs, and do not attempt to repair the projector yourself.

During a thunderstorm, do not touch the projector or the cable.

Electric shocks can result.

Do not do anything that might damage the power cord or the power plug.

If the power cord is used while damaged, electric shocks, short-circuits or fire will result.

- Do not damage the power cord, make any modifications to it, place it near any hot objects, bend it excessively, twist it, pull it, place heavy objects on top of it or wrap it into a bundle.

Ask an Authorized Service Center to carry out any repairs to the power cord that might be necessary.

Completely insert the power plug into the wall outlet and the power connector into the projector terminal.

If the plug is not inserted correctly, electric shocks or overheating will result.

- Do not use plugs which are damaged or wall outlets which are coming loose from the wall.

Do not use anything other than the provided power cord.

Failure to observe this will result in fire or electric shocks. Please note that if you do not use the provided power cord to ground the device on the side of the outlet, this may result in electric shocks.

Clean the power plug regularly to prevent it from becoming covered in dust.

Failure to observe this will cause a fire.

- If dust builds up on the power plug, the resulting humidity can damage the insulation.
- If not using the projector for an extended period of time, pull the power plug out from the wall outlet.

Pull the power plug out from the wall outlet and wipe it with a dry cloth regularly.

Do not handle the power plug and power connector with wet hands.

Failure to observe this will result in electric shocks.

Do not overload the wall outlet.

If the power supply is overloaded (ex., by using too many adapters), overheating may occur and fire will result.

■ **ON USE/INSTALLATION**

Do not place the projector on soft materials such as carpets or sponge mats.

Doing so will cause the projector to overheat, which can cause burns, fire or damage to the projector.

Do not set up the projector in humid or dusty places or in places where the projector may come into contact with oily smoke or steam, ex. a bathroom.

Using the projector under such conditions will result in fire, electric shocks or deterioration of components.

Deterioration of components (such as ceiling mount brackets) may cause the projector which is mounted on the ceiling to fall down.

Do not install this projector in a place which is not strong enough to take the full weight of the projector or on top of a surface which is sloped or unstable.

Failure to observe this will cause projector to fall down or tip over the projector, and severe injury or damage could result.

WARNING:

Do not cover the air intake/exhaust ports or place anything within 500 mm (20") of them.

Doing so will cause the projector to overheat, which can cause fire or damage to the projector.

- Do not place the projector in narrow, badly ventilated places.
- Do not place the projector on cloth or papers, as these materials could be drawn into the air intake port.

Do not place your hands or other objects close to the air exhaust port.

Doing so will cause burns or damage your hands or other objects.

- Heated air comes out of the air exhaust port. Do not place your hands or face, or objects which cannot withstand heat close to this port.

Do not look at the light emitted from the lens while the projector is being used.

Doing so can cause loss of sight.

- Strong light is emitted from the projector's lens. Do not directly look at this light.
- Be especially careful not to let young children look into the lens. In addition, turn off the power and disconnect the power plug when you are away from the projector.

Never attempt to remodel or disassemble the projector.

High voltages can cause fire or electric shocks.

- For any inspection, adjustment and repair work, please contact an Authorized Service Center.

Do not project an image with the lens cover of the projection lens (optional) attached.

Doing so can cause fire.

Do not allow metal objects, flammable objects, or liquids to enter inside of the projector. Do not allow the projector to get wet.

Doing so may cause short circuits or overheating, and result in fire, electric shock, or malfunction of the projector.

- Do not place containers of liquid or metal objects near the projector.
- If liquid enters inside of the projector, consult your dealer.
- Particular attention must be paid to children.

Use the ceiling mount bracket specified by Panasonic.

Using the ceiling mount bracket other than the specified one will result in falling accidents.

- Attach the supplied safety cable to the ceiling mount bracket to prevent the projector from falling down.

Installation work (such as ceiling mount bracket) should only be carried out by a qualified technician.

If installation is not carried out and secured correctly it can cause injury or accidents, such as electric shocks.

- Do not use anything other than an authorized ceiling mount bracket.
- Be sure to use the provided accessory wire with an eye bolt as an extra safety measure to prevent the projector from falling down. (Install in a different location to the ceiling mount bracket.)

WARNING:

■ **ACCESSORIES**

Do not use or handle the batteries improperly, and refer to the following.

Failure to observe this will cause burns, batteries to leak, overheat, explode or catch fire.

- Use AA/R6 batteries.
- Do not use unspecified batteries.
- Do not use chargeable batteries.
- Do not disassemble dry cell batteries.
- Do not heat the batteries or place them into water or fire.
- Do not allow the + and – terminals of the batteries to come into contact with metallic objects such as necklaces or hairpins.
- Do not store or carry batteries together with metallic objects.
- Store the batteries in a plastic bag and keep them away from metallic objects.
- Make sure the polarities (+ and –) are correct when inserting the batteries.
- Do not use a new battery together with an old battery or mix different types of batteries.
- Do not use batteries with the outer cover peeling away or removed.

If the battery fluid leaks, do not touch it with bare hands, and take the following measures if necessary.

- Battery fluid on your skin or clothing could result in skin inflammation or injury.
Rinse with clean water and seek medical advice immediately.
- Battery fluid coming in contact with your eyes could result in loss of sight.
In this case, do not rub your eyes. Rinse with clean water and seek medical advice immediately.

Do not remove unspecified screws during the lamp unit replacement.

Doing so can cause electric shocks, burns, or injury.

Do not disassemble the lamp unit.

If the lamp breaks, it could cause injury.

Lamp replacement

The lamp has high internal pressure. If improperly handled, an explosion and severe injury or accidents will result.

- The lamp can easily explode if struck against hard objects or dropped.
- Before replacing the lamp unit, be sure to turn the power off and to disconnect the power plug from the wall outlet.
Electric shocks or explosions can result if this is not done.
- When replacing the lamp unit, turn the power off and allow the lamp to cool for at least one hour before handling it otherwise it can cause burns.

Do not use the supplied power cord with devices other than this projector.

- Using the supplied power cord with devices other than this projector may cause short circuits or overheating, and result in electric shock or fire.

Keep accessories (screws) out of the reach of small children.

Accidentally swallowing them can cause physical harm.

- If you believe that parts have been swallowed, seek medical advice immediately.

Remove the depleted batteries from the remote control promptly.

- Leaving them in the unit may result in fluid leakage, overheating, or explosion of the batteries.

CAUTION:

■ POWER

When disconnecting the power cord, be sure to hold the power plug and power connector.

If the power cord itself is pulled, the lead will become damaged, and fire, short-circuits or serious electric shocks will result.

When not using the projector for an extended period of time, disconnect the power plug from the wall outlet.

Failure to do so may result in fire or electric shock.

Disconnect the power plug from the wall outlet before carrying out any cleaning and replacing the unit.

Failure to do so may result in electric shock.

■ ON USE/INSTALLATION

Do not place heavy objects on top of the projector.

Failure to observe this will cause the projector to become unbalanced and fall, which could result in damage or injury. The projector will be damaged or deformed.

Do not put your weight on this projector.

You could fall or the projector could break, and injury will result.

- Be especially careful not to let young children stand or sit on the projector.

Do not place the projector in extremely hot locations.

Doing so will cause the outer casing or internal components to deteriorate, or result in fire.

- Take particular care in locations exposed to direct sunlight or near stoves.

Do not place your hands in the openings beside the optical lens, while shifting the lens.

Failure to observe this could cause injury.

Do not stand in front of the lens while the projector is being used.

Doing so can cause damage and burns to clothing.

- Extremely strong light is emitted from the projector's lens.

Do not place objects in front of the lens while the projector is being used.

Doing so can cause damage to the object and can cause the set to malfunction.

- Extremely strong light is emitted from the projector's lens.

Always disconnect all cables before moving the projector.

Moving the projector with cables still attached can damage the cables, which will cause fire or electric shocks to occur.

When mounting the projector on the ceiling, keep mounting screws and power cord from contact with metal parts inside the ceiling.

Contact with metal parts inside the ceiling can cause electric shocks.

■ ACCESSORIES

Do not use the old lamp unit.

If used it could cause lamp explosion.

If the lamp has broken, ventilate the room immediately. Do not touch or bring your face close to the broken pieces.

Failure to observe this will cause the user to absorb the gas which was released when the lamp broke and which contains nearly the same amount of mercury as fluorescent lamps, and the broken pieces will cause injury.

- If you believe that you have absorbed the gas or that the gas has got into your eyes or mouth, seek medical advice immediately.
- Ask your dealer about replacing the lamp unit and check the inside of the projector.

When not using the projector for an extended period of time, remove the batteries from the remote control.

Failure to observe this will cause the batteries to leak, overheat, catch fire or explode, which may result in fire or contamination of surrounding area.

CAUTION:

■ **MAINTENANCE**

Do not attach the air filter unit while it is wet.

Doing so may result in electric shock or malfunctions.

- After you clean the air filter units, dry them thoroughly before reattaching them.

Do not touch the fan with your fingers or any other parts of your body when replacing the lamp unit.

Doing so can cause injury.

Ask your dealer about cleaning inside the projector once a year.

Continuous use while dust is accumulated inside the projector may result in fire.

- For cleaning fee, ask your dealer.

■ **VIEWING 3D VIDEO (PT-DZ13KE, PT-DS12KE, and PT-DW11KE only)**

Those with a medical history of oversensitivity to light, heart problems, or poor physical health should not view 3D images.

This may lead to a worsening of medical conditions.

If you feel tiredness or discomfort, or other abnormality while viewing with 3D Eyewear, discontinue viewing.

Continuing use may cause health problems. Take a break as necessary.

When viewing 3D movies, aim to view one movie at a time and take a break as necessary.

When viewing 3D images, for example when playing 3D games or using a PC where two way interaction is possible, take an appropriate break every 30 to 60 minutes.

Watching for long periods of time may cause eye fatigue.

When preparing contents, use contents properly created to be used for 3D.

This may cause eye fatigue or health problems.

When viewing 3D images, pay attention to people and objects in the vicinity.

3D video may be mistaken for actual objects, and the related bodily movements can cause damage to objects and lead to injury.

Use 3D Eyewear when viewing 3D videos.

Do not tilt your head when viewing with 3D Eyewear.

Those who are near or far sighted, those with weaker eyesight in one eye, or those with astigmatism should use corrective glasses etc. when using 3D Eyewear.

If the image appears distinctly double when viewing 3D video, discontinue viewing.

Watching for long periods of time may cause eye fatigue.

View at a distance of at least three times the effective height of the screen.

Viewing at distance closer than the recommended distance may cause eye fatigue. As with movies, if there are black bands at the top and bottom of the video, view at a distance of 3 times or more of the height of the video section.

Children younger than 5 or 6 years old should not use 3D Eyewear.

As it is difficult to gauge the reactions of children to fatigue and discomfort their condition may worsen suddenly. If a child uses the 3D Eyewear, guardians should beware of the child's eyes becoming tired.



To remove the battery

Remote Control Battery

1. Press the guide and lift the cover.

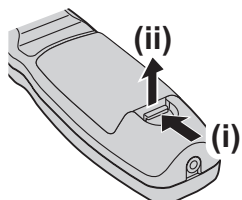

2. Remove the batteries.

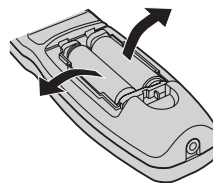

■ Trademarks

- Windows®, Windows Vista®, and Internet Explorer® are registered trademarks or trademarks of Microsoft Corporation in the United States and other countries.
- Mac, Mac OS, OS X, and Safari are trademarks of Apple Inc., registered in the United States and other countries.
- PJLink™ is a registered trademark or pending trademark in Japan, the United States, and other countries and regions.
- HDMI, the HDMI Logo, and High-Definition Multimedia Interface are trademarks or registered trademarks of HDMI Licensing LLC in the United States and other countries.
- VGA and XGA are trademarks of International Business Machines Corporation in the United States.
- SVGA is a trademark or registered trademark of Video Electronics Standards Association.
- RoomView and Crestron RoomView are registered trademarks of Crestron Electronics, Inc. Crestron Connected and Fusion RV are trademarks of Crestron Electronics, Inc.
- Art-Net™ Designed by and Copyright Artistic Licence Holdings Ltd
- Adobe Flash Player is a trademark or registered trademark of Adobe Systems Inc. in the United States and/or other countries.
- RealD 3D is a trademark of RealD Inc.
- Some of the fonts used in the on-screen menu are Ricoh bitmap fonts, which are manufactured and sold by Ricoh Company, Ltd.
- All other names, company names, and product names mentioned in this manual are trademarks or registered trademarks of their respective owners.
Please note that the ® and ™ symbols are not specified in this manual.

■ Illustrations in this manual

- Illustrations of the projector, screen, and other parts may vary from the actual product.

■ Reference pages

- Reference pages in this manual are indicated as (➡ page 00).

■ Term

- In this manual, the “Wireless/wired remote control unit” accessory is referred to as “Remote control”.

Features of the Projector

High luminance and high color reproduction

- ▶ High luminance and high color reproduction are achieved with a small size by means of a unique optical system and lamp drive system.

Easy setup and improved serviceability

- ▶ In addition to the extensive lineup of optional lenses that allows more flexible setup of the projector, “portrait mode” is supported.

Improved cost performance in maintenance fee

- ▶ The extended-life filter reduces maintenance costs.

Quick Steps

For details, refer to the corresponding pages.

1. **Set up the projector.**
(⇒ page 31)



2. **Attach the projection lens (optional).**
(⇒ page 46)



3. **Connect with external devices.**
(⇒ page 48)



4. **Connect the power cord.**
(⇒ page 52)



5. **Switch on the projector.**
(⇒ page 53)



6. **Make initial settings.**
(⇒ page 22)
 - Take this step when you switch on the power for the first time after purchasing the projector.



7. **Select the input signal.**
(⇒ page 56)



8. **Adjust the image.**
(⇒ page 56)

Contents

Be sure to read “Read this first!” from page 2.

Read this first! 2

Chapter 1 Preparation

Precautions for use	16
Cautions when transporting	16
Cautions when installing	16
Security	18
Art-Net	18
Disposal	18
Cautions on use	18
Software information regarding this product	19
Accessories	20
Optional accessories	21
Start-up display	22
Focus adjustment	22
Initial setting (display language)	22
Initial setting (installation setting)	23
Initial setting (screen setting)	23
About your projector	24
Remote control	24
Projector body	25
Using the remote control	28
Inserting and removing the batteries	28
Setting the remote control ID numbers	28
Connecting to the projector with a cable	29

Chapter 2 Getting Started

Setting up	31
Installation mode	31
Parts for ceiling mount (optional)	32
Screen size and throw distance	32
Adjusting adjustable feet	45
Attaching/removing the projection lens (optional)	46
Attaching the projection lens	46
Removing the projection lens	46
Connecting	48
Before connecting	48
Connecting example: AV equipment	49
Connecting example: Computers	50

Chapter 3 Basic Operations

Switching on/off the projector	52
Connecting the power cord	52
Power indicator	52
Switching on the projector	53
Making adjustments and selections	54
Switching off the projector	55
Direct power off function	55
Projecting	56
Selecting the input signal	56
Adjusting the focus, zoom, and shift	56
Moving the lens to the home position	57
Adjustment range by the lens position shift (optical shift)	57
Adjusting the lens mounter when the focus is unbalanced	58
Operating with the remote control	61
Using the shutter function	61
Using the on-screen display function	61
Switching the input signal	62
Using the Status function	62
Using the Automatic setup function	62
Using the Function button	63
Displaying the internal test pattern	63
Changing the picture aspect ratio	63

Chapter 4 Settings

Menu navigation	65
Navigating through the menu	65
Main menu	66
Sub-menu	67
[PICTURE] menu	71
[PICTURE MODE]	71
[CONTRAST]	71
[BRIGHTNESS]	72
[COLOR]	72
[TINT]	72
[COLOR TEMPERATURE]	72
[GAMMA]	74
[SYSTEM DAYLIGHT VIEW]	75
[SHARPNESS]	75
[NOISE REDUCTION]	76
[DYNAMIC IRIS]	76
[SYSTEM SELECTOR]	77
sRGB-compliant video	78

Contents

[POSITION] menu	79	[PROJECTOR SETUP] menu	108
[SHIFT].....	79	[PROJECTOR ID].....	108
[ASPECT].....	79	[PROJECTION METHOD].....	108
[ZOOM].....	80	[COOLING CONDITION].....	109
[CLOCK PHASE].....	81	[HIGH ALTITUDE MODE].....	109
[GEOMETRY].....	81	[LAMP SELECT].....	109
[KEystone].....	84	[LAMP RELAY].....	110
[ADVANCED MENU] menu	85	[LAMP POWER].....	111
[DIGITAL CINEMA REALITY].....	85	[BRIGHTNESS CONTROL].....	111
[BLANKING].....	85	[STANDBY MODE].....	115
[INPUT RESOLUTION].....	86	[SCHEDULE].....	116
[CLAMP POSITION].....	86	[STARTUP INPUT SELECT].....	117
[EDGE BLENDING].....	87	[RS-232C].....	118
[FRAME RESPONSE].....	88	[STATUS].....	119
[FRAME LOCK].....	89	[NO SIGNAL SHUT-OFF].....	120
[RASTER POSITION].....	89	[REMOTE2 MODE].....	120
[DISPLAY LANGUAGE] menu	90	[FUNCTION BUTTON].....	121
Changing the display language.....	90	[DATE AND TIME].....	121
[3D SETTINGS] menu	91	[LENS CALIBRATION].....	122
[3D SYSTEM SETTING].....	91	[LENS MEMORY].....	122
[3D SYNC SETTING].....	91	[SAVE ALL USER DATA].....	124
[3D SIMUL INPUT SETTING].....	92	[LOAD ALL USER DATA].....	124
[3D INPUT FORMAT].....	92	[INITIALIZE].....	124
[LEFT/RIGHT SWAP].....	93	[SERVICE PASSWORD].....	124
[3D COLOR MATCHING].....	93	[P IN P] menu	125
[3D PICTURE BALANCE].....	93	Using P IN P function.....	125
[DARK TIME SETTING].....	94	[TEST PATTERN] menu	127
[3D FRAME DELAY].....	94	[TEST PATTERN].....	127
[3D TEST MODE].....	94	[SIGNAL LIST] menu	128
[3D TEST PATTERN].....	95	Registering new signals.....	128
[SAFETY PRECAUTIONS MESSAGE].....	95	Renaming the registered signal.....	128
[3D SAFETY PRECAUTIONS].....	95	Deleting the registered signal.....	128
[DISPLAY OPTION] menu	96	Protecting the registered signal.....	129
[COLOR MATCHING].....	96	Expanding signal lock-in range.....	129
[LARGE SCREEN CORRECTION].....	97	Sub memory.....	130
[SCREEN SETTING].....	97	[SECURITY] menu	131
[AUTO SIGNAL].....	98	[SECURITY PASSWORD].....	131
[AUTO SETUP].....	98	[SECURITY PASSWORD CHANGE].....	131
[RGB IN].....	99	[DISPLAY SETTING].....	132
[DVI-D IN].....	100	[TEXT CHANGE].....	132
[HDMI IN].....	100	[CONTROL DEVICE SETUP].....	132
[SDI IN].....	100	[CONTROL DEVICE PASSWORD CHANGE]	133
[ON-SCREEN DISPLAY].....	102	[NETWORK] menu	135
[BACK COLOR].....	103	[NETWORK SETUP].....	135
[STARTUP LOGO].....	104	[NETWORK CONTROL].....	135
[UNIFORMITY].....	104	[NETWORK STATUS].....	136
[SHUTTER SETTING].....	105	[Art-Net SETUP].....	136
[FREEZE].....	105	Network connections.....	136
[WAVEFORM MONITOR].....	105	Accessing from the web browser.....	138
[CUT OFF].....	107		

Chapter 5 Maintenance

Lamp/temperature/filter indicators 156
 When an indicator lights up 156
Maintenance/replacement 158
 Before performing maintenance/replacement 158
 Maintenance 158
 Replacing the unit 160
Troubleshooting 164

Chapter 6 Appendix

Technical information 167
 PJLink protocol 167
 Using Art-Net function 168
 Control commands via LAN 169
 <SERIAL IN>/<SERIAL OUT> terminal 171
 <REMOTE 2 IN> terminal 175
 Two-window display combination list 176
 Control device password 176
 Upgrade Kit 177
 List of compatible signals 177
Specifications 182
Dimensions 185
Precautions for Ceiling Mount Bracket for Projectors 186
Index 187

Chapter 1 Preparation

This chapter describes things you need to know or check before using the projector.

Precautions for use

Cautions when transporting

- The projection lens (optional) is susceptible to effects due to vibration or impact. Make sure to remove the lens when transporting.
- When transporting the projector, hold it securely by its bottom and avoid excessive vibration and impacts. They may damage the internal components and result in malfunctions.
- Do not transport the projector with the adjustable feet extended. Doing so may damage the adjustable feet.

Cautions when installing

■ After removing the projection lens (optional), attach the dust sponge included with the projector.

Otherwise dust will accumulate inside and may cause malfunctions.

■ Do not set up the projector outdoors.

The projector is designed for indoor use only.

■ Do not set up the projector in the following locations.

- Places where vibration and impacts occur such as in a car or vehicle: Doing so may cause damage to internal components or malfunction.
- Near the exhaust of an air conditioner: Depending on the conditions of use, the screen may fluctuate in rare cases due to the heated air from the air exhaust port or the hot or cooled air. Make sure that the exhaust from the projector or other equipment, or the air from the air conditioner does not blow toward the front of the projector.
- Places with sharp temperature fluctuations such as near lights (studio lamps): Doing so may shorten the life of the lamp, or result in deformation of the outer case due to heat, which may cause malfunctions.

The operating environment temperature of the projector should be between 0 °C (32 °F) and 45 °C (113 °F) when using it at elevations lower than 1 400 m (4 593') above sea level, and between 0 °C (32 °F) and 40 °C (104 °F) when using it at high altitudes (1 400 m (4 593') or higher – lower than 2 700 m (8 858') above sea level).

If you use the Smoke cut filter, the operating environment temperature should be between 0 °C (32 °F) and 35 °C (95 °F). However, it cannot be used at high altitudes.

If you use the Replacement lamp unit (for portrait mode), the operating environment temperature should be between 0 °C (32 °F) and 40 °C (104 °F) when using the projector at elevations lower than 1 400 m (4 593') above sea level, and between 0 °C (32 °F) and 35 °C (95 °F) when using the projector at high altitudes. If you use the Smoke cut filter together, the operating environment temperature should be between 0 °C (32 °F) and 30 °C (86 °F).

- Near high-voltage power lines or near motors: Doing so may interfere with the operation of the projector.
- Places where there is high-power laser equipment: Directing a laser beam onto the lens surface causes damage to the DLP chips.

■ Be sure to ask a specialized technician or your dealer when installing the projector on a ceiling.

The optional Ceiling Mount Bracket for Projectors is required.

Model No.: ET-PKD310H (for High Ceilings), ET-PKD310S (for Low Ceilings)

■ Lens focus

The high clarity projection lens is thermally affected by the light from the light source, making the focus unstable in the period just after switching on the power. Wait at least 30 minutes with the image projected before adjusting the lens focus.

■ Make sure to set [HIGH ALTITUDE MODE] to [ON] when using the projector at elevations between 1 400 m (4 593') or higher and lower than 2 700 m (8 858') above sea level.

Failure to do so may shorten the life of the components and result in malfunctions.

■ Make sure to set [HIGH ALTITUDE MODE] to [OFF] when using the projector at elevations lower than 1 400 m (4 593') above sea level.

Failure to do so may shorten the life of the components and result in malfunctions.

■ Do not install the projector at elevations of 2 700 m (8 858') or higher above sea level.

Doing so may shorten the life of the components and result in malfunctions.

■ **Do not use the projector tilted to the right or left.**

Using the projector at a vertical angle that exceeds 15° may reduce product life or result in malfunction.

■ **When installing and using the projector at an angle that exceeds 30° vertically, set [COOLING CONDITION] (➔ page 109).**

Failure to observe this may shorten the life of the components or result in malfunctions.

■ **When using the Replacement lamp unit (for portrait mode), install the projector with the terminals surface facing down.**

Do not use the projector tilted to the right and left, front and back. Using the projector at an angle that exceeds 15° in either direction may reduce the life of the components or result in malfunctions.

■ **Cautions when setting up the projector**

- When installing and using the projector with a method other than the floor standing installation using the adjustable feet, fix the projector using the five screw holes for ceiling mount (as shown in the figure).
(Screw diameter: M6, tapping depth inside the set: 16 mm (5/8"), torque: $4 \pm 0.5 \text{ N}\cdot\text{m}$)
- Make a clearance of at least 5 mm (3/16") between the projector bottom and the setting surface by inserting spacers (metallic) between them.

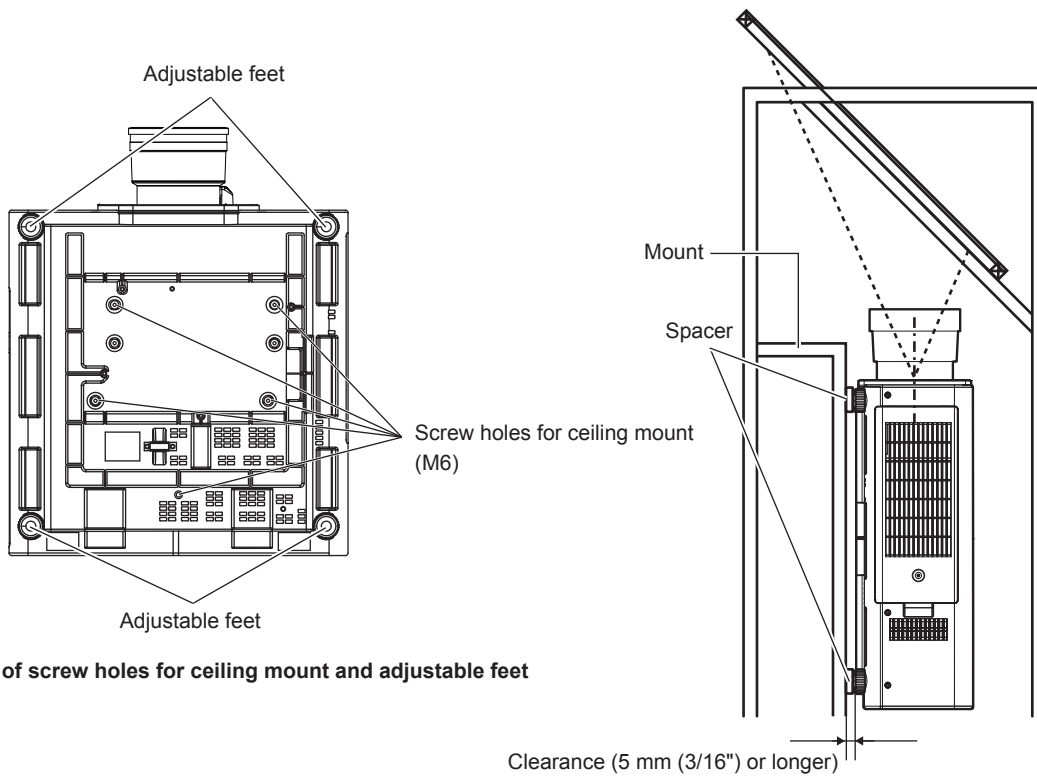

The positions of screw holes for ceiling mount and adjustable feet

Ensure the inflow of air into the air intake port. Otherwise the projector may not work properly.

- The adjustable feet can be removed if not needed in the installation. However, do not use the screw holes where the adjustable feet were removed to fix the projector in place.
Also, do not install other screws in the screw holes of adjustable feet. Doing so may damage the projector.
Note that the length of the front feet differ from that of the rear feet when attaching the removed adjustable feet. The ones with a longer screw are for the front. (Length of the screw for front feet: 65 mm (2-9/16"), length of the screw for rear feet: 23 mm (29/32"))
- Use the adjustable feet only for the floor standing installation and for adjusting the angle. Using them for other purposes may damage the projector.
- Do not stack projectors on top of each other.
- Do not use the projector supporting it by the top.
- Do not use the projector tilted at an angle that exceeds $\pm 15^\circ$ from the horizontal plane.
- Do not block the ventilation ports (intake and exhaust) of the projector.

- Prevent hot and cool air from the air conditioning system to blow directly to the ventilation ports (intake and exhaust) of the projector.

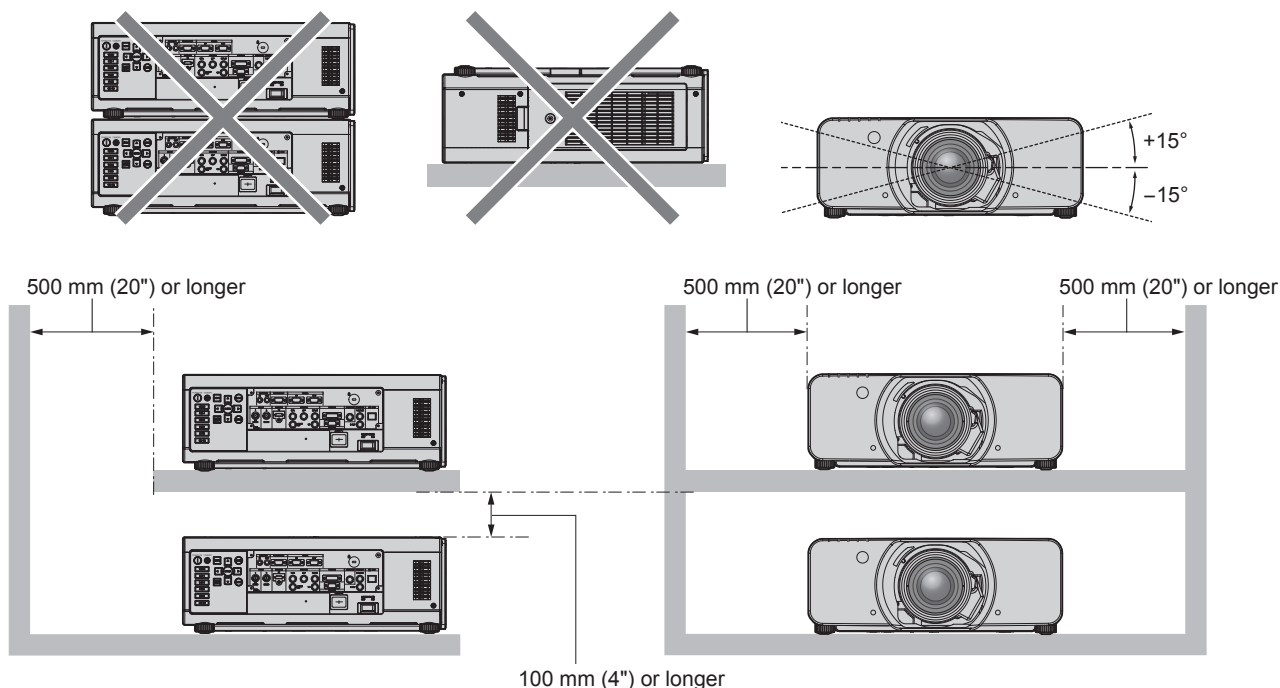

- Do not install the projector in a confined space.
When it is necessary to install the projector in a confined space, install the air conditioning or ventilation separately. Exhaust heat may accumulate when the ventilation is not enough, triggering the protection circuit of the projector.

Security

When using this product, take safety measures against the following incidents.

- Personal information being leaked via this product
 - Unauthorized operation of this product by a malicious third party
 - Interfering or stopping of this product by a malicious third party
- Take sufficient security measures. (➔ pages 131, 151)
- Make your password difficult to guess as much as possible.
 - Change your password periodically.
 - Panasonic Corporation or its affiliate companies will never ask for your password directly. Do not divulge your password in case you receive such inquiries.
 - The connecting network must be secured by a firewall, etc.
 - Set a password for the web control and restrict the users who can log in.

Art-Net

“Art-Net” is an Ethernet communication protocol based on the TCP/IP protocol.

By using the DMX controller or application software, illumination and stage system can be controlled. Art-Net is made based on DMX512 communication protocol.

Disposal

To dispose of the product, ask your local authorities or dealer for correct methods of disposal.

The lamp contains mercury. When disposing of used lamp units, contact your local authorities or dealer for correct methods of disposal.

Cautions on use

■ To get a good picture quality

In order to view a beautiful image in higher contrast, prepare an appropriate environment. Draw curtains or blinds over windows and turn off any lights near the screen to prevent outside light or light from indoor lamps from shining onto the screen.

■ Do not touch the surface of the projection lens with your bare hands.

If the surface of the projection lens becomes dirty from fingerprints or anything else, this will be magnified and projected onto the screen.

Attach the supplied lens cover to the projection lens when you do not use the projector.

■ DLP chips

- The DLP chips are precision-made. Note that in rare cases, pixels of high precision could be missing or always lit. Note that such phenomena does not indicate malfunction.
- Directing a high-power laser beam onto the lens surface can damage the DLP chips.

■ Do not move the projector or subject it to vibration or impact while it is operating.

Doing so may shorten the life of the built-in motor.

■ Lamp

The light source of the projector is a high-pressure mercury lamp.

A high-pressure mercury lamp has the following characteristics.

- The luminance of the lamp will decrease by duration of usage.
- The lamp may burst with a loud sound or have its service life shortened because of shock, chipping, or degradation due to cumulative runtime.
- The lamp life varies greatly depending on individual differences and usage conditions. In particular, frequent on/off switching of the power greatly deteriorate the lamp and affects the lamp life.
- Continuous use for over one week will deteriorate the lamp. The degradation of the lamp due to continuous use can be reduced by using the [PROJECTOR SETUP] menu → [LAMP RELAY].
- In rare cases, the lamps burst shortly after projection starts.
- The risk of bursting increases when the lamp is used beyond its replacement cycle. Make sure to replace the lamp unit regularly.
("When to replace the lamp unit" (➡ page 161), "How to replace the lamp unit" (➡ page 162))
- If the lamp bursts, gas contained inside of the lamp is released in the form of smoke.
- It is recommended that you store the Replacement lamp unit as a contingency.

■ Computer and external device connections

- When connecting a computer or an external device, read this manual carefully regarding the use of power cords and shielded cables as well.
- Use a commercial cable with a ferrite core for connecting with the <DVI-D IN> terminal.

■ Viewing 3D images

(Only for PT-DZ13KE, PT-DS12KE, PT-DW11KE)

The projector can display 3D video signals that are input through various systems such as "frame packing" and "side by side". You are required to prepare external devices for viewing 3D images (such as 3D eyewear, video signal output devices) which are suitable for your 3D system. For connections of the projector and external devices, they are different depends on the 3D system to be used, see the operating instructions of external devices you use.

Refer to "List of 3D compatible signals" (➡ page 179) for the types of 3D video signals that can be used with the projector.

Software information regarding this product

© Panasonic Corporation 2013

This product is equipped with the following software:

- (1) Software which is developed independently by or for Panasonic Corporation
- (2) Software which is licensed under GNU GENERAL PUBLIC LICENSE
- (3) Software which is licensed under GNU LESSER GENERAL PUBLIC LICENSE

For license conditions related to software in (2) and (3), refer to the provisions of the software licenses (GNU GENERAL PUBLIC LICENSE and GNU LESSER GENERAL PUBLIC LICENSE) in the supplied CD-ROM. (Those provisions are written in English because they have been stipulated by third parties.)

If you have any questions regarding the software, please contact us via email (sav.pj.gpl.pavc@ml.jp.panasonic.com).

Accessories

Make sure that the following accessories are provided with your projector. Numbers enclosed in < > show the number of accessories.

Wireless/wired remote control unit <1>
(N2QAYB000769)



CD-ROM <1>
(TXFQB02VLF9)

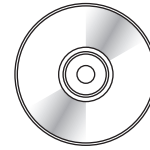

Power cord <1>
(TXFSX01RGRZ)

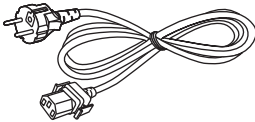

AA/R6 battery <2>

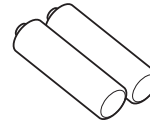

(For remote control unit)

Power cord <1>
(TXFSX02RGRZ)

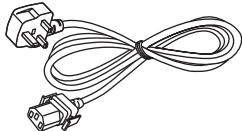

Lens fixing screw <1>
(XYN4+J18FJ)



Attention

- After unpacking the projector, discard the power cord cap and packaging material properly.
- Do not use the supplied power cord for devices other than this projector.
- For missing accessories, consult your dealer.
- Store small parts in an appropriate manner, and keep them away from small children.

Note

- The model numbers of accessories are subject to change without prior notice.

Contents of the supplied CD-ROM

The contents of the supplied CD-ROM are as follows.

Instruction/list (PDF)	Operating Instructions – Functional Manual	
	Multi Projector Monitoring & Control Software Operating Instructions	
	Logo Transfer Software Operating Instructions	
	List of Compatible Projector Models	This is a list of projectors that are compatible with the software contained in the CD-ROM and their restrictions.
	Software license	GNU GENERAL PUBLIC LICENSE, GNU LESSER GENERAL PUBLIC LICENSE
Software	Multi Projector Monitoring & Control Software (Windows)	This software allows you to monitor and control multiple projectors connected to the LAN.
	Logo Transfer Software (Windows)	This software allows you to transfer original images, such as company logos to be displayed when projection starts, to the projector.

Optional accessories

Optional accessories (product name)	Model No.	
Projection lens	Zoom lens	ET-D75LE6, ET-D75LE8, ET-D75LE10, ET-D75LE20, ET-D75LE30, ET-D75LE40
	Fixed-focus lens	ET-D75LE50
Ceiling Mount Bracket for Projectors	ET-PKD310H (for High Ceilings), ET-PKD310S (for Low Ceilings)	
Projector ceiling mount bracket	ET-PAD310	
Projector Frame for projectors	ET-PFD310	
Replacement lamp unit	ET-LAD310A (1 pc), ET-LAD310AW (2 pcs)	
Replacement lamp unit (for portrait mode)	ET-LAD320P (1 pc), ET-LAD320PW (2 pcs)	
Replacement Filter Unit	ET-EMF320	
Smoke cut filter	ET-SFD320	
Smoke cut filter (Replacement)	ET-SFR320	
Upgrade Kit	ET-UK20 (only for PT-DZ13KE, PT-DS12KE)	

Note

- The model numbers of optional accessories are subject to change without prior notice.

Start-up display

When the projector is switched on for the first time after purchase as well as when [ALL USER DATA] in the [PROJECTOR SETUP] menu → [INITIALIZE] is executed, the focus adjustment screen is displayed after projection starts, then the initial setting screen is displayed. Set them in accordance with circumstances.

In other occasions, you can change the settings by menu operations.

Focus adjustment

Adjust the focus to display the menu screen clearly.

You may also need to adjust the zoom and shift.

Refer to “Adjusting the focus, zoom, and shift” (➔ page 56) for details.

- 1) Press ▲▼◀▶ to adjust the focus.

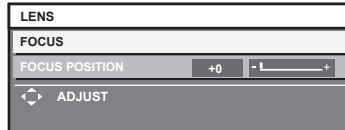

- 2) Press the <MENU> button to proceed to the initial setting.

Initial setting (display language)

Select the language to show on the screen.

After completed the initial setting, you can change the display language from the [DISPLAY LANGUAGE] menu.

- 1) Press ▲▼ to select the display language.

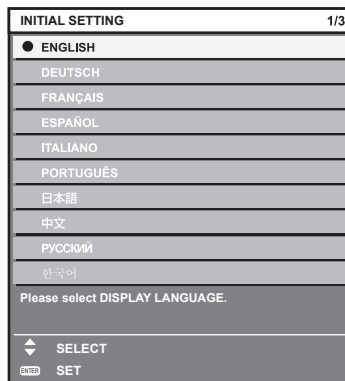

- 2) Press the <ENTER> button to proceed to the initial setting.

Initial setting (installation setting)

Set [PROJECTION METHOD] and [COOLING CONDITION] depending on the installation mode. Refer to “Installation mode” (➔ page 31) for details.

Set [HIGH ALTITUDE MODE] to [ON] when using the projector at high altitudes between 1 400 m (4 593') or higher and lower than 2 700 m (8 858') above sea level.

After completed the initial setting, you can change the settings of each item from the [PROJECTOR SETUP] menu.

- 1) Press ▲▼ to select an item.
- 2) Press ◀▶ to switch the setting.

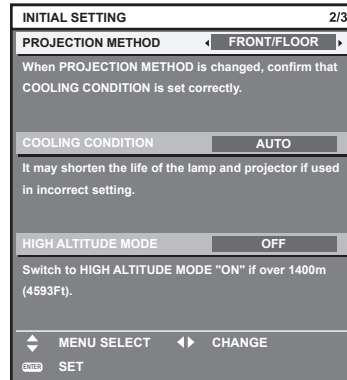

- 3) Press the <ENTER> button to proceed to the initial setting.

Initial setting (screen setting)

(Only for PT-DZ13KE, PT-DS12KE, PT-DZ10KE)

Set the screen format (aspect ratio) and display position of the image. After completed the initial setting, you can change the settings of each item from the [DISPLAY OPTION] menu → [SCREEN SETTING].

- 1) Press ▲▼ to select an item.
- 2) Press ◀▶ to switch the setting.

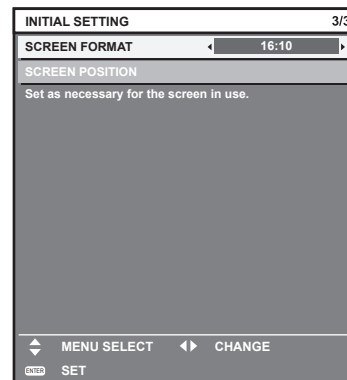

- [SCREEN FORMAT] (➔ page 97)
- [SCREEN POSITION] (➔ page 97)

- 3) Press the <ENTER> button.
 - Confirm the setting value and complete the initial setting.

Note

- If you press the <MENU> button on the initial setting screen, you can go back to the previous screen.
- To continue operations after completed the initial settings, refer to “Selecting the input signal” (➔ page 56).
- By default, the time zone of the projector is set to +09:00 (Japan and Korean Standard Time). Change the setting in the [PROJECTOR SETUP] menu → [DATE AND TIME] → [TIME ZONE] to the time zone of the region where you use the projector.

About your projector

Remote control

■ Front

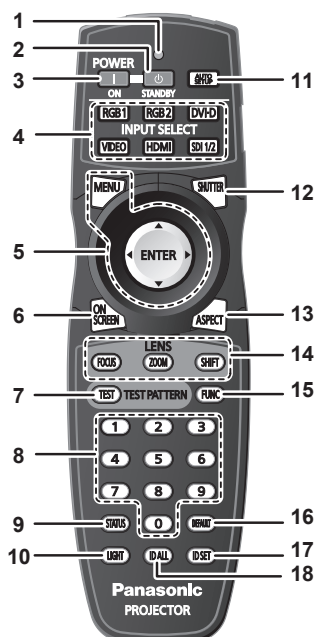

■ Side

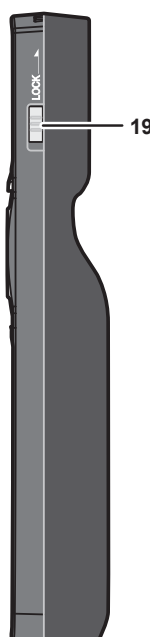

■ Top

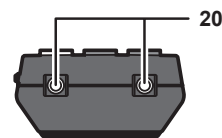

■ Bottom

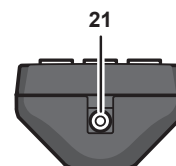

- 1 **Remote control indicator**
Flashes if any button in the remote control is pressed.
- 2 **Power standby <⏻> button**
Sets the projector to the state where the projector is switched off (standby mode) when the <MAIN POWER> switch on the projector is set to <ON> and in projection mode.
- 3 **Power on <|> button**
Starts projection when the <MAIN POWER> switch on the projector is set to <ON> when the power is switched off (standby mode).
- 4 **Input selection (<RGB1>, <RGB2>, <DVI-D>, <VIDEO>, <HDMI>, <SDI 1/2>) buttons**
Switches the input signal to project. (➔ page 62)
- 5 **<MENU> button/<ENTER> button/▲▼◀▶ buttons**
Used to navigate through the menu screen. (➔ page 65)
- 6 **<ON SCREEN> button**
Switches on (display)/off (hide) the on-screen display function. (➔ page 61)
- 7 **<TEST> button**
Displays the test pattern. (➔ page 63)
- 8 **Number (<0> - <9>) buttons**
Used when the system uses multiple projectors.
Used to input ID numbers or passwords.
- 9 **<STATUS> button**
Displays the projector information.
- 10 **<LIGHT> button**
Pressing this button lights up the remote control buttons. The lights will go off when the remote control operation goes idle for 10 seconds.
- 11 **<AUTO SETUP> button**
Automatically adjusts the image display position while projecting the image.
[PROGRESS] is displayed on the screen while adjusting automatically. (➔ page 62)
- 12 **<SHUTTER> button**
Used to temporarily turn off the image. (➔ page 61)
- 13 **<ASPECT> button**
Switches the aspect ratio of the image. (➔ page 63)
- 14 **Lens (<FOCUS>, <ZOOM>, <SHIFT>) buttons**
Adjusts the projection lens. (➔ page 56)
- 15 **<FUNC> button**
Assigns a frequently used operation as a shortcut button. (➔ page 63)
- 16 **<DEFAULT> button**
Resets the content of the sub-menu to the factory default. (➔ page 66)
- 17 **<ID SET> button**
Sets the ID number of the remote control to use for a system using multiple projectors. (➔ page 28)
- 18 **<ID ALL> button**
Used to simultaneously control all the projectors with one remote control for a system using multiple projectors. (➔ page 28)
- 19 **<LOCK> button**
Used to prevent unintended operation by careless pressing of the buttons and prevent draining the remote control batteries.
- 20 **Remote control signal transmitter**
- 21 **Remote control wired terminal**
Connects to the projector with a cable. (➔ page 29)

Attention

- Do not drop the remote control.
- Avoid contact with liquids or moisture.
- Do not attempt to modify or disassemble the remote control.

Note

- The remote control can be used within a distance of about 30 m (98'5") if pointed directly at the remote control signal receiver. The remote control can control at angles of up to $\pm 15^\circ$ vertically and $\pm 30^\circ$ horizontally, but the effective control range may be reduced.
- If there are any obstacles between the remote control and the remote control signal receiver, the remote control may not operate properly.
- The signal will be reflected off the screen. However, the operating range may be limited from light reflection loss due to the screen material.
- If the remote control signal receiver directly receives strong light, such as fluorescent light, the remote control may not operate properly. Use it in a place distant from the light source.
- The power indicator <ON (G)/STANDBY (R)> will flash if the projector receives a remote control signal.

Projector body

■ **Front**

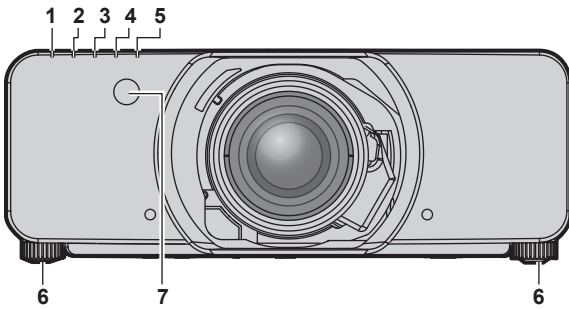

■ **Side**

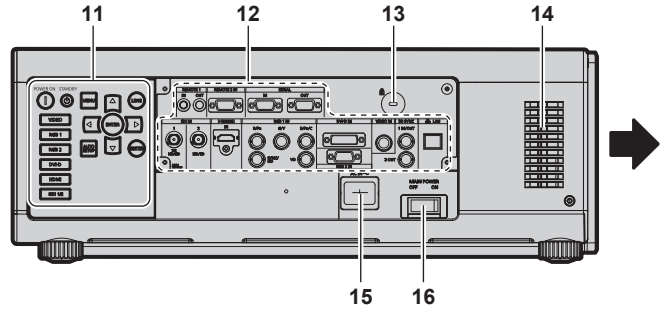

■ **Rear**

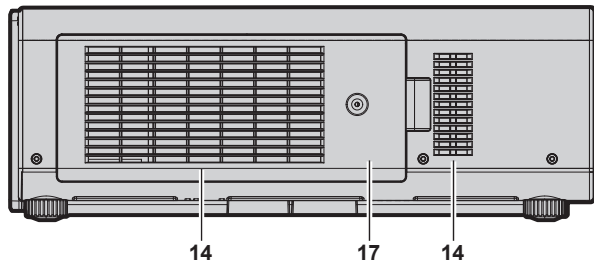
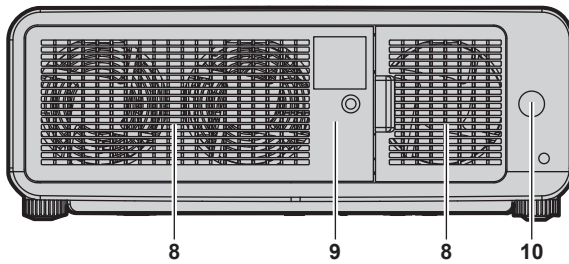

■ **Bottom**

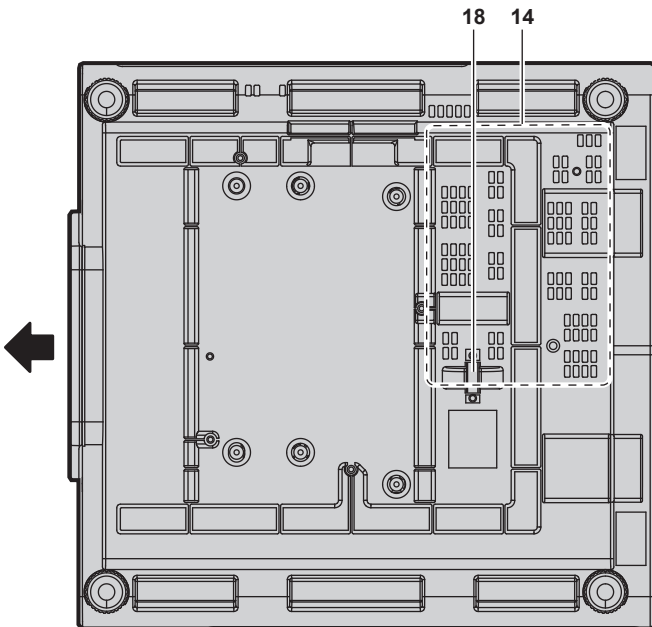

← : Projection direction

WARNING

Keep your hands and other objects away from the air exhaust port.

- Keep your hands and face away.
- Do not insert your fingers.
- Keep heat-sensitive objects away.

Heated air from the air exhaust port can cause burns, injury, or deformations.

- 1 Power indicator <ON (G)/STANDBY (R)>**
Displays the status of the power.
- 2 Lamp indicator <LAMP1>**
Displays the status of lamp 1.
- 3 Lamp indicator <LAMP2>**
Displays the status of lamp 2.
- 4 Temperature indicator <TEMP>**
Displays the internal temperature status.
- 5 Filter indicator <FILTER>**
Displays the status of the air filter unit.
- 6 Adjustable feet**
Adjusts the projection angle.
- 7 Remote control signal receiver (front)**
- 8 Air exhaust port**
- 9 Lamp unit cover**
- 10 Remote control signal receiver (rear)**
- 11 Control panel (⇒ page 26)**
- 12 Connecting terminals (⇒ page 27)**

13 Security slot

This security slot is compatible with the Kensington security cables.

14 Air intake port

15 <AC IN> terminal

Connect the supplied power cord.

16 <MAIN POWER> switch

Turns on/off the main power.

17 Air filter cover

The air filter unit is inside.

18 Burglar hook port

Attaches a burglar prevention cable, etc.

Attention

- Do not block the ventilation ports (intake and exhaust) of the projector.

■ Control panel

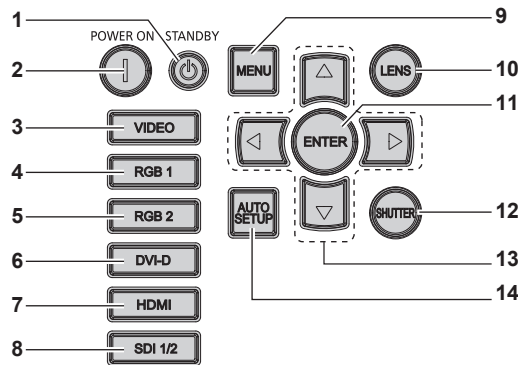

1 Power standby <⏻> button

Sets the projector to the state where the projector is switched off (standby mode) when the <MAIN POWER> switch on the projector is set to <ON> and in projection mode.

2 Power on <|> button

Starts projection when the <MAIN POWER> switch on the projector is set to <ON> when the power is switched off (standby mode).

3 <VIDEO> button

Switches the input to VIDEO.

4 <RGB1> button

Switches the input to RGB1.

5 <RGB2> button

Switches the input to RGB2.

6 <DVI-D> button

Switches the input to DVI-D.

7 <HDMI> button

Switches the input to HDMI.

8 <SDI 1/2> button

Switches the input to SDI.
(Only for PT-DZ13KE, PT-DS12KE, PT-DZ10KE)

9 <MENU> button

Displays or hides the main menu. (➔ page 65)
Returns to the previous menu when a sub-menu is displayed.
If you press the <MENU> button on the control panel for at least three seconds while the on-screen display is off, the on-screen display is turned on.

10 <LENS> button

Adjusts the focus, zoom, and shift (position) of the lens.

11 <ENTER> button

Determines and executes an item in the menu screen.

12 <SHUTTER> button

Used to temporarily turn off the image. (➔ page 61)

13 ▲▼◀▶ buttons

Use to select items in the menu screen, change settings, and adjust levels.
Also used to enter a password in [SECURITY] or enter characters.

14 <AUTO SETUP> button

Automatically adjusts the image display position while projecting the image. [PROGRESS] is displayed on the screen while adjusting automatically. (➔ page 62)

■ Connecting terminals

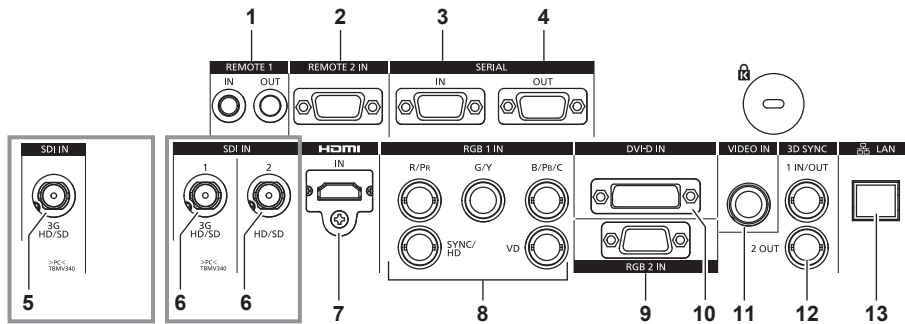

- | | |
|---|---|
| <p>1 <REMOTE 1 IN> terminal/<REMOTE 1 OUT> terminal
These are the terminals to connect the remote control for serial control when the system uses multiple projectors.</p> <p>2 <REMOTE 2 IN> terminal
This is a terminal to remotely control the projector using the external control circuit.</p> <p>3 <SERIAL IN> terminal
This is the RS-232C compatible terminal to externally control the projector by connecting a computer.</p> <p>4 <SERIAL OUT> terminal
This is a terminal to output the signal connected to the <SERIAL IN> terminal.</p> <p>5 <SDI IN> terminal
This is the terminal to input SDI signals. (Only for PT-DZ10KE)</p> <p>6 <SDI IN 1> terminal / <SDI IN 2> terminal
This is the terminal to input SDI signals. (Only for PT-DZ13KE, PT-DS12KE)</p> <p>7 <HDMI IN> terminal
This is the terminal to input HDMI signals.</p> | <p>8 <RGB 1 IN> (<R/P_R>, <G/Y>, <B/P_B/C>, <SYNC/HD>, <VD>) terminal
This is a terminal to input RGB signals or the YC_BC_R/YP_BP_R and Y/C signals.</p> <p>9 <RGB 2 IN> terminal
This is a terminal to input RGB signals or YC_BC_R/YP_BP_R signals.</p> <p>10 <DVI-D IN> terminal
This is the terminal to input DVI-D signals.</p> <p>11 <VIDEO IN> terminal
This is the terminal to input video signals.</p> <p>12 <3D SYNC 1 IN/OUT> terminal / <3D SYNC 2 OUT> terminal
This is a terminal to input or output control signals when using the projector in 3D systems. (Only for PT-DZ13KE, PT-DS12KE, PT-DW11KE)</p> <p>13 <LAN> terminal
This is a terminal to connect to the network. Used for control and monitoring. Image input through network connections is not possible.</p> |
|---|---|

Attention

- When a LAN cable is directly connected to the projector, the network connection must be made indoors.

Using the remote control

Inserting and removing the batteries

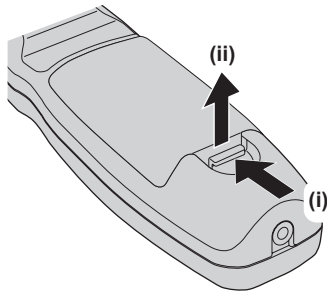

Fig. 1

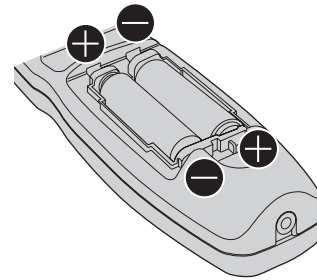

Fig. 2

- 1) **Open the cover. (Fig. 1)**
- 2) **Insert the batteries and close the cover (insert the \ominus side first). (Fig. 2)**
 - When removing the batteries, perform the steps in reverse order.

Setting the remote control ID numbers

When you use the system with multiple projectors, you can operate all the projectors simultaneously or each projector individually using single remote control, if a unique ID number is assigned to each projector.

After setting the ID number of the projector, set same ID number on the remote control.

The factory default ID number of the projector is set to [ALL]. When using a single projector, press the <ID ALL> button on the remote control. Also, you can control a projector by pressing the <ID ALL> button on the remote control even if you do not know the projector ID.

How to set

- 1) **Press the <ID SET> button on the remote control.**
- 2) **Within five seconds, press the two-digit ID number set on the projector using the number (<0> - <9>) buttons.**
 - If you press the <ID ALL> button, you can control the projectors regardless of the ID number setting of the projector.

Attention

- Since the ID number of the remote control can be set without the projector, do not press the <ID SET> button carelessly. If the <ID SET> button is pressed and no number (<0> - <9>) buttons are pressed within five seconds, the ID number returns to its original value before the <ID SET> button was pressed.
- The ID number set on the remote control will be stored unless it is set again. However, it will be erased if the remote control is left with dead batteries. Set the same ID number again when the batteries are replaced.

Note

- Set the ID number of the projector from the [PROJECTOR SETUP] menu → [PROJECTOR ID].

Connecting to the projector with a cable

When you use the system with multiple projectors, use commercial M3 stereo mini jack cables and connect the other devices to the <REMOTE 1 IN>/<REMOTE 1 OUT> terminals of the projector body.

The remote control is effective even in places where an obstacle stands in the light path or where devices are susceptible to outside light.

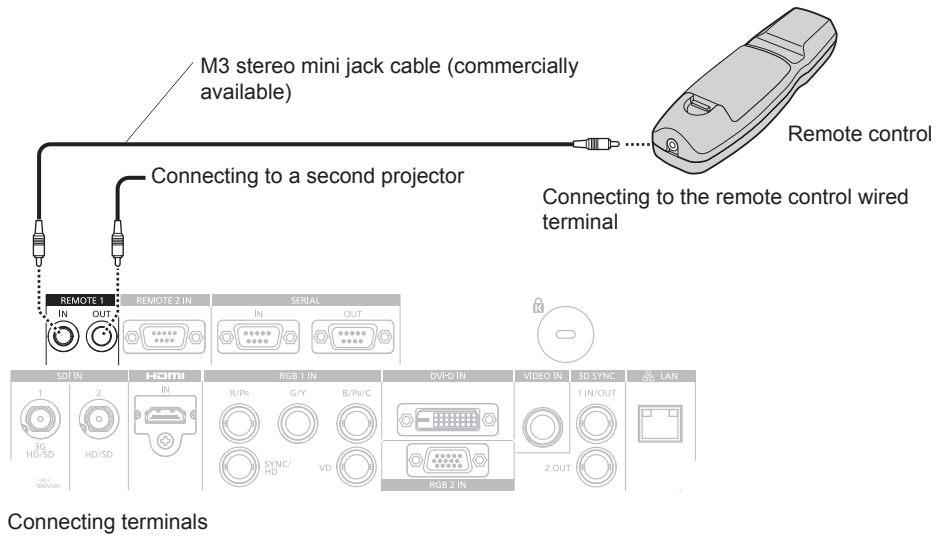

Attention

- Use a cable that is 15 m (49'2") or shorter, with 2 core shield. The remote control may not operate when the length of the cable exceeds 15 m (49'2") or when the shielding of the cable is inadequate.

Chapter 2 **Getting Started**

This chapter describes things you need to do before using the projector such as the setup and connections.

Setting up

Installation mode

There are six ways to set up the projector. Set the [PROJECTOR SETUP] menu → [PROJECTION METHOD] (➔ page 108) depending on the installation location. Set [COOLING CONDITION] (➔ page 109) to [AUTO]. Using the projector with [COOLING CONDITION] set incorrectly may shorten the life of the lamp.

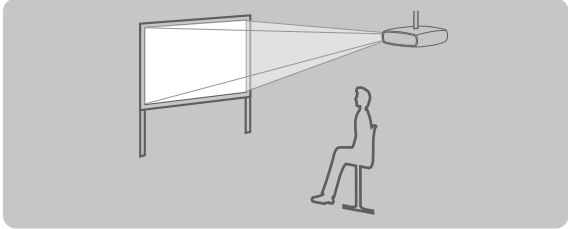
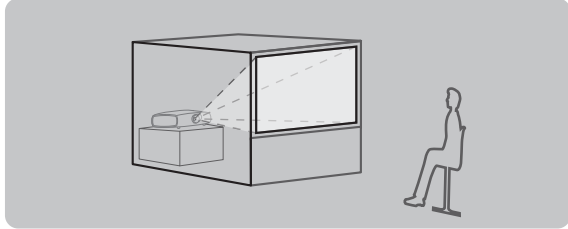
Mounting on the ceiling and projecting forward 		Setting on a desk/floor and projecting from rear (Using the translucent screen) 	
Menu item	Method	Menu item	Method
[PROJECTION METHOD]	[FRONT/CEILING]	[PROJECTION METHOD]	[REAR/FLOOR]
[COOLING CONDITION]	[CEILING SETTING]	[COOLING CONDITION]	[FLOOR SETTING]

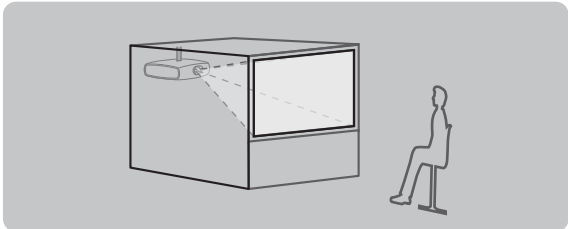
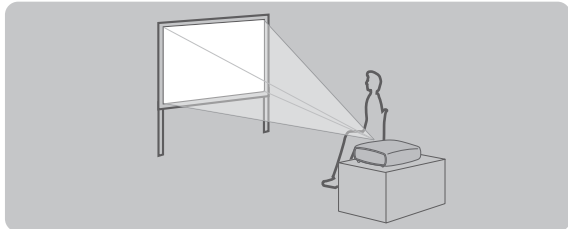
Mounting on the ceiling and projecting from rear (Using the translucent screen) 		Setting on a desk/floor and projecting forward 	
Menu item	Method	Menu item	Method
[PROJECTION METHOD]	[REAR/CEILING]	[PROJECTION METHOD]	[FRONT/FLOOR]
[COOLING CONDITION]	[CEILING SETTING]	[COOLING CONDITION]	[FLOOR SETTING]

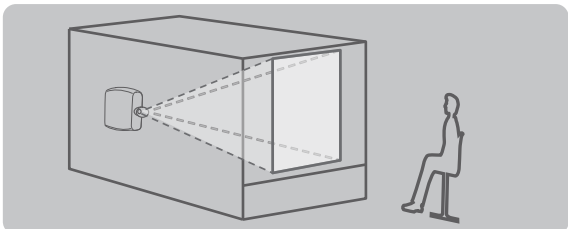
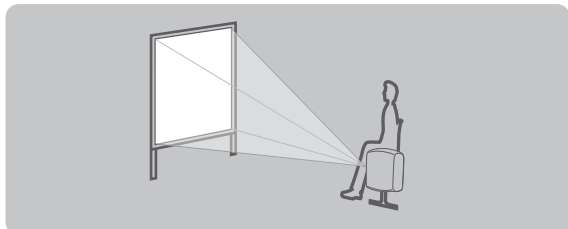
Portrait setting and projecting from the rear*1 (Using the translucent screen) 		Portrait setting and projecting forward*1 	
Menu item	Method	Menu item	Method
[PROJECTION METHOD]	[REAR/FLOOR]	[PROJECTION METHOD]	[FRONT/FLOOR]
[COOLING CONDITION]	[PORTRAIT SETTING]*2	[COOLING CONDITION]	[PORTRAIT SETTING]*2

*1 For the portrait setting, use the optional Replacement lamp unit (for portrait mode) (Model No.: ET-LAD320P (1 pc), ET-LAD320PW (2 pcs)).

*2 Using the optional Replacement lamp unit (for portrait mode) (Model No.: ET-LAD320P (1 pc), ET-LAD320PW (2 pcs)) will set the cooling condition to [PORTRAIT SETTING].

Note

- In the portrait setting, the on-screen menu is displayed sideways.

Parts for ceiling mount (optional)

You can install the projector on the ceiling using the optional Ceiling Mount Bracket for Projectors (Model No.: ET-PKD310H (for High Ceilings), ET-PKD310S (for Low Ceilings)).

- Be sure to use the Ceiling Mount Bracket for Projectors specified for this projector.
- Refer to the Installation Instructions supplied with the Ceiling Mount Bracket for Projectors when installing the projector with the bracket.

Attention

- To ensure projector performance and security, installation of the Ceiling Mount Bracket for Projectors must be carried out by your dealer or a qualified technician.

Screen size and throw distance

Refer to the screen size and projection distances to install the projector. Image size and image position can be adjusted in accordance with the screen size and screen position.

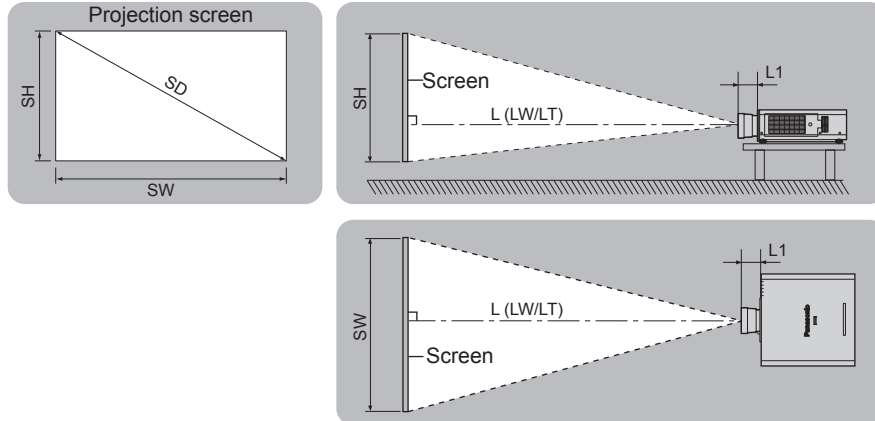

(Unit: m)

L (LW/LT)*1	Projection distance
L1	Lens protrusion dimension
SH	Image height
SW	Image width
SD	Image diagonal size

- *1 LW: Minimum projection distance when the Zoom Lens is used
 LT: Maximum projection distance when the Zoom Lens is used

(Unit: m)

Projection lens Model No.	L1 dimension (approximate value)
ET-D75LE1	0.1144
ET-D75LE2	0.0989
ET-D75LE3	0.1024
ET-D75LE4	0.1263
ET-D75LE5	0.2024
ET-D75LE6	0.2119
ET-D75LE8	0.2544
ET-D75LE10	0.125
ET-D75LE20	0.121
ET-D75LE30	0.121
ET-D75LE40	0.124
ET-D75LE50	0.203

Attention

- Before setting up, read "Precautions for use" (➔ page 16).
- Do not use the projector and the high-powered laser equipment in the same room. The DLP chips can be damaged if a laser beam hits the lens surface.

[GEOMETRY] projection range

(Only for PT-DZ13KE, PT-DS12KE, PT-DZ10KE)

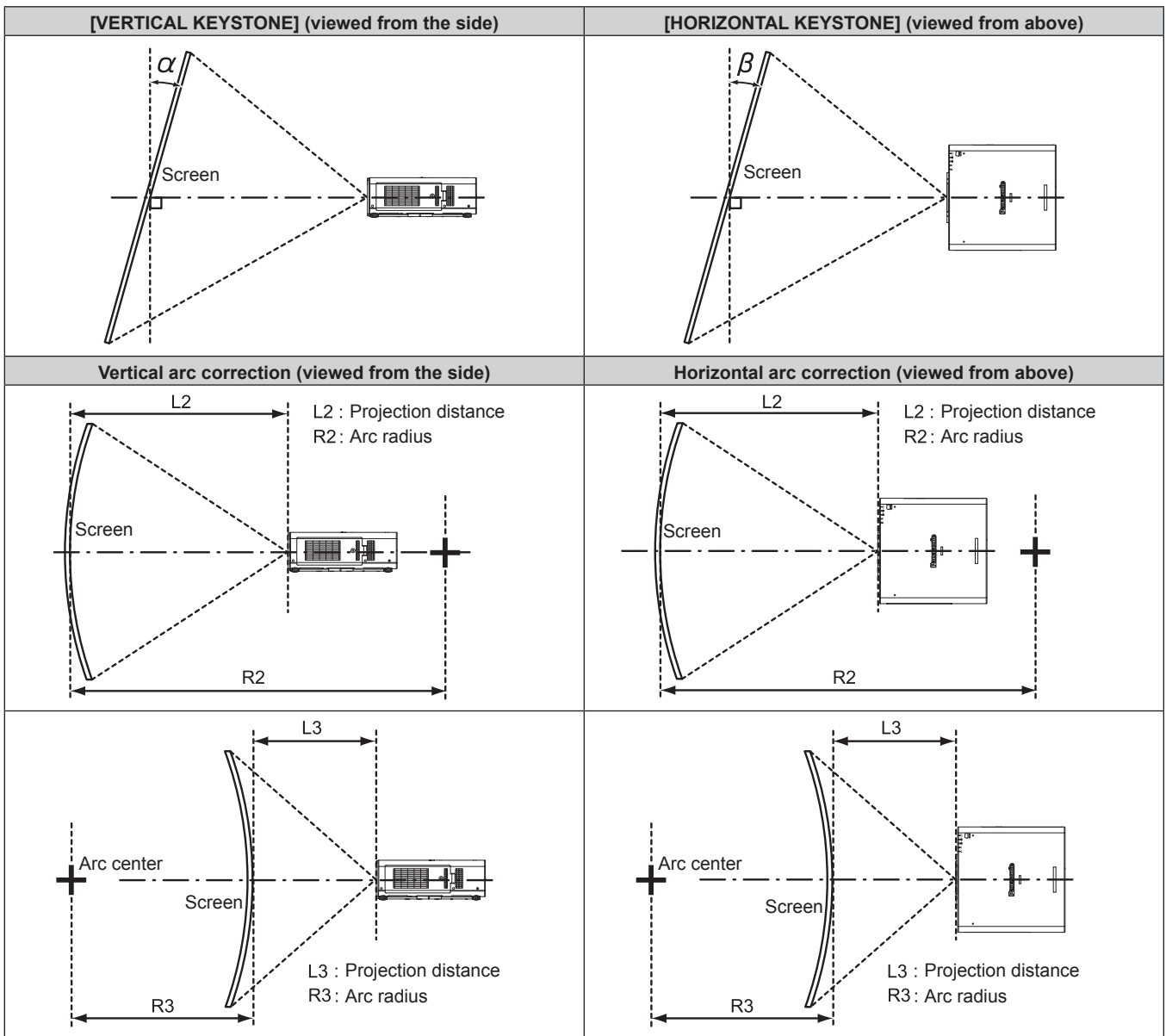

Standard status

Projection lens Model No.	Only for [KEYSTONE]		[KEYSTONE] and [CURVED] used together				Only for [CURVED]	
	Vertical keystone correction angle α (°)	Horizontal keystone correction angle β (°)	Vertical keystone correction angle α (°)	Horizontal keystone correction angle β (°)	Min. value of R2/L2	Min. value of R3/L3	Min. value of R2/L2	Min. value of R3/L3
ET-D75LE1	±40	±15	±20	±15	1.0	2.3	0.6	1.3
ET-D75LE2	±40	±15	±20	±15	0.8	1.6	0.5	0.9
ET-D75LE3	±40	±15	±20	±15	0.6	1.1	0.3	0.6
ET-D75LE4	±40	±15	±20	±15	0.4	0.7	0.2	0.4
ET-D75LE5	±22	±15	±8	±8	2.0	4.9	1.2	2.9
ET-D75LE6	±28	±15	±10	±10	1.6	3.9	0.9	2.3
ET-D75LE8	±40	±15	±20	±15	0.2	0.4	0.2	0.3
ET-D75LE10	±40	±15	±20	±15	1.1	2.6	0.6	1.5
ET-D75LE20	±40	±15	±20	±15	0.9	1.7	0.5	1.0
ET-D75LE30	±40	±15	±20	±15	0.6	1.2	0.4	0.7
ET-D75LE40	±40	±15	±20	±15	0.4	0.7	0.2	0.4
ET-D75LE50	±22	±15	±8	±8	2.0	4.9	1.2	2.9

When using the optional Upgrade Kit (Model No.: ET-UK20)

(Only for PT-DZ13KE, PT-DS12KE)

Projection lens Model No.	Only for [KEystone]		[KEystone] and [CURVED] used together				Only for [CURVED]	
	Vertical keystone correction angle α (°)	Horizontal keystone correction angle β (°)	Vertical keystone correction angle α (°)	Horizontal keystone correction angle β (°)	Min. value of R2/L2	Min. value of R3/L3	Min. value of R2/L2	Min. value of R3/L3
ET-D75LE1	±40	±40	±20	±15	0.8	1.8	0.5	1.0
ET-D75LE2	±40	±40	±20	±15	0.6	1.2	0.4	0.7
ET-D75LE3	±45	±40	±20	±15	0.4	0.8	0.3	0.5
ET-D75LE4	±45	±40	±20	±15	0.3	0.5	0.2	0.3
ET-D75LE5	±22	±15	±8	±8	1.5	3.7	0.9	2.2
ET-D75LE6	±28	±15	±10	±10	1.2	3.0	0.7	1.7
ET-D75LE8	±45	±40	±20	±15	0.2	0.3	0.1	0.2
ET-D75LE10	±40	±40	±20	±15	0.9	2.0	0.5	1.1
ET-D75LE20	±40	±40	±20	±15	0.7	1.3	0.4	0.7
ET-D75LE30	±45	±40	±20	±15	0.5	0.9	0.3	0.5
ET-D75LE40	±45	±40	±20	±15	0.3	0.5	0.2	0.3
ET-D75LE50	±22	±15	±8	±8	1.5	3.7	0.9	2.2

*1 Cannot correct [VERTICAL KEYSTONE] and [HORIZONTAL KEYSTONE] if the total exceeds 55° when used at the same time.

Note

- When [GEOMETRY] is used, the focus of the entire screen may be lost as correction increases.
- Make the curved screen a circular arc shape with one part of a perfect circle removed.
- Adjustment range of the [GEOMETRY] items may not match the listed projection range depending on the projection lens. Use this projector within the projection range, otherwise the correction may not work.

Projection distance of each projection lens

A ±5 % error in listed projection distances may occur.

In addition, when [GEOMETRY] and [KEYSTONE] are used, distance is corrected to become smaller than the specified screen size.

For PT-DZ13KE, PT-DZ10KE

■ **When the screen aspect is 16:10**

(Unit: m)

Lens type			Zoom lens											
Projection lens Model No.			ET-D75LE1		ET-D75LE2		ET-D75LE3		ET-D75LE4		ET-D75LE8		ET-D75LE6	
Throw ratio*1			1.4-1.8:1		1.8-2.8:1		2.8-4.6:1		4.6-7.4:1		7.3-13.8:1		0.9-1.1:1	
Projection screen size			Projection distance (L)											
Diagonal (SD)	Height (SH)	Width (SW)	Min. (LW)	Max. (LT)	Min. (LW)	Max. (LT)	Min. (LW)	Max. (LT)	Min. (LW)	Max. (LT)	Min. (LW)	Max. (LT)	Min. (LW)	Max. (LT)
1.78 (70")	0.942	1.508	2.01	2.69	2.72	4.10	4.11	6.90	6.91	11.06	10.78	20.56	1.35	1.62
2.03 (80")	1.077	1.723	2.31	3.09	3.12	4.70	4.71	7.90	7.91	12.66	12.37	23.55	1.55	1.86
2.29 (90")	1.212	1.939	2.61	3.49	3.52	5.30	5.31	8.91	8.91	14.25	13.97	26.54	1.76	2.10
2.54 (100")	1.346	2.154	2.91	3.89	3.92	5.90	5.91	9.91	9.91	15.85	15.57	29.53	1.96	2.34
3.05 (120")	1.615	2.585	3.51	4.68	4.73	7.10	7.11	11.91	11.92	19.04	18.76	35.50	2.36	2.82
3.81 (150")	2.019	3.231	4.40	5.88	5.93	8.90	8.91	14.92	14.93	23.82	23.54	44.47	2.96	3.55
5.08 (200")	2.692	4.308	5.89	7.87	7.93	11.91	11.92	19.94	19.95	31.80	31.52	59.41	3.97	4.75
6.35 (250")	3.365	5.385	7.39	9.87	9.93	14.91	14.92	24.95	24.96	39.77	39.49	74.36	4.98	5.96
7.62 (300")	4.039	6.462	8.88	11.86	11.93	17.91	17.92	29.97	29.98	47.75	47.47	89.30	5.99	7.17
8.89 (350")	4.712	7.539	10.37	13.86	13.93	20.91	20.92	34.98	34.99	55.72	55.44	104.24	6.99	8.37
10.16 (400")	5.385	8.616	11.86	15.85	15.94	23.92	23.93	40.00	40.01	63.70	63.42	119.19	8.00	9.58
12.70 (500")	6.731	10.770	14.85	19.84	19.94	29.92	29.93	50.03	50.04	79.65	79.37	149.08	10.01	11.99
15.24 (600")	8.077	12.923	17.83	23.82	23.94	35.93	35.94	60.06	60.07	95.60	95.32	178.96	12.03	14.40
25.40 (1000")	13.462	21.539	29.77	39.77	39.96	59.95	59.96	100.18	100.19	159.40	159.13	—	20.08	24.06

Lens type			Zoom lens								Fixed-focus lens	
Projection lens Model No.			ET-D75LE10		ET-D75LE20		ET-D75LE30		ET-D75LE40		ET-D75LE5	ET-D75LE50
Throw ratio*1			1.3-1.7:1		1.7-2.4:1		2.4-4.7:1		4.6-7.4:1		0.7:1	0.7:1
Projection screen size			Projection distance (L)									
Diagonal (SD)	Height (SH)	Width (SW)	Min. (LW)	Max. (LT)	Min. (LW)	Max. (LT)	Min. (LW)	Max. (LT)	Min. (LW)	Max. (LT)	Fixed	Fixed
1.78 (70")	0.942	1.508	1.90	2.46	2.46	3.58	3.56	6.94	6.87	11.04	0.99	1.01
2.03 (80")	1.077	1.723	2.19	2.83	2.82	4.11	4.08	7.96	7.88	12.65	1.15	1.16
2.29 (90")	1.212	1.939	2.47	3.20	3.19	4.64	4.61	8.98	8.88	14.25	1.30	1.32
2.54 (100")	1.346	2.154	2.76	3.56	3.55	5.17	5.13	9.99	9.88	15.85	1.45	1.47
3.05 (120")	1.615	2.585	3.32	4.30	4.28	6.22	6.18	12.03	11.89	19.05	1.76	1.78
3.81 (150")	2.019	3.231	4.18	5.40	5.37	7.81	7.75	15.08	14.90	23.85	2.22	2.24
5.08 (200")	2.692	4.308	5.60	7.24	7.19	10.45	10.38	20.16	19.92	31.86	2.99	3.01
6.35 (250")	3.365	5.385	7.02	9.07	9.00	13.09	13.0	25.25	24.95	39.86	3.76	3.78
7.62 (300")	4.039	6.462	8.44	10.91	10.82	15.73	15.62	30.34	29.97	47.87	4.53	4.56
8.89 (350")	4.712	7.539	9.86	12.74	12.64	18.37	18.24	35.42	34.99	55.87	—	5.33
10.16 (400")	5.385	8.616	11.28	14.58	14.46	21.01	20.86	40.51	40.01	63.87	—	6.10
12.70 (500")	6.731	10.770	14.12	18.25	18.09	26.29	26.11	50.68	50.05	79.88	—	7.64
15.24 (600")	8.077	12.923	16.96	21.92	21.73	31.58	31.35	60.85	60.09	95.89	—	9.18
25.40 (1000")	13.462	21.539	28.33	36.61	36.27	52.70	52.33	101.53	100.25	159.93	—	15.35

*1 The throw ratio is based on the value during projection onto a 3.81 m (150") screen size.

■ When the screen aspect is 16:9

(Unit: m)

Lens type			Zoom lens											
Projection lens Model No.			ET-D75LE1		ET-D75LE2		ET-D75LE3		ET-D75LE4		ET-D75LE8		ET-D75LE6	
Throw ratio*1			1.4-1.8:1		1.8-2.8:1		2.8-4.6:1		4.6-7.4:1		7.3-13.8:1		0.9-1.1:1	
Projection screen size			Projection distance (L)											
Diagonal (SD)	Height (SH)	Width (SW)	Min. (LW)	Max. (LT)	Min. (LW)	Max. (LT)	Min. (LW)	Max. (LT)	Min. (LW)	Max. (LT)	Min. (LW)	Max. (LT)	Min. (LW)	Max. (LT)
1.78 (70")	0.872	1.550	2.07	2.77	2.80	4.21	4.23	7.09	7.10	11.37	11.09	21.14	1.39	1.66
2.03 (80")	0.996	1.771	2.38	3.18	3.21	4.83	4.84	8.13	8.13	13.01	12.73	24.21	1.60	1.91
2.29 (90")	1.121	1.992	2.68	3.59	3.62	5.45	5.46	9.16	9.16	14.65	14.37	27.29	1.81	2.16
2.54 (100")	1.245	2.214	2.99	4.00	4.04	6.07	6.08	10.19	10.19	16.29	16.01	30.36	2.01	2.41
3.05 (120")	1.494	2.657	3.60	4.82	4.86	7.30	7.31	12.25	12.26	19.57	19.29	36.50	2.43	2.90
3.81 (150")	1.868	3.321	4.53	6.05	6.09	9.15	9.16	15.34	15.35	24.49	24.21	45.72	3.05	3.65
5.08 (200")	2.491	4.428	6.06	8.10	8.15	12.24	12.25	20.50	20.50	32.69	32.40	61.08	4.08	4.89
6.35 (250")	3.113	5.535	7.59	10.15	10.21	15.33	15.34	25.65	25.66	40.88	40.60	76.44	5.12	6.13
7.62 (300")	3.736	6.641	9.13	12.19	12.27	18.41	18.42	30.81	30.81	49.08	48.80	91.79	6.15	7.37
8.89 (350")	4.358	7.748	10.66	14.24	14.32	21.50	21.51	35.96	35.97	57.28	57.00	107.15	7.19	8.61
10.16 (400")	4.981	8.855	12.19	16.29	16.38	24.58	24.60	41.12	41.12	65.47	65.19	122.51	8.22	9.85
12.70 (500")	6.226	11.069	15.26	20.39	20.50	30.76	30.77	51.42	51.43	81.87	81.59	153.23	10.29	12.33
15.24 (600")	7.472	13.283	18.33	24.49	24.61	36.93	36.94	61.73	61.74	98.26	97.98	183.95	12.36	14.81
25.40 (1000")	12.453	22.138	30.60	40.88	41.07	61.62	61.63	102.97	102.98	163.83	163.56	—	20.64	24.73

Lens type			Zoom lens								Fixed-focus lens	
Projection lens Model No.			ET-D75LE10		ET-D75LE20		ET-D75LE30		ET-D75LE40		ET-D75LE5	ET-D75LE50
Throw ratio*1			1.3-1.7:1		1.7-2.4:1		2.4-4.7:1		4.6-7.4:1		0.7:1	0.7:1
Projection screen size			Projection distance (L)									
Diagonal (SD)	Height (SH)	Width (SW)	Min. (LW)	Max. (LT)	Min. (LW)	Max. (LT)	Min. (LW)	Max. (LT)	Min. (LW)	Max. (LT)	Fixed	Fixed
1.78 (70")	0.872	1.550	1.96	2.53	2.53	3.68	3.66	7.14	7.07	11.36	1.02	1.04
2.03 (80")	0.996	1.771	2.25	2.91	2.91	4.23	4.20	8.19	8.10	13.00	1.18	1.20
2.29 (90")	1.121	1.992	2.54	3.29	3.28	4.77	4.74	9.23	9.13	14.65	1.34	1.36
2.54 (100")	1.245	2.214	2.83	3.67	3.65	5.31	5.28	10.28	10.16	16.29	1.50	1.51
3.05 (120")	1.494	2.657	3.42	4.42	4.40	6.40	6.35	12.37	12.23	19.58	1.81	1.83
3.81 (150")	1.868	3.321	4.29	5.55	5.52	8.03	7.97	15.50	15.32	24.52	2.29	2.31
5.08 (200")	2.491	4.428	5.75	7.44	7.39	10.74	10.67	20.73	20.48	32.75	3.08	3.10
6.35 (250")	3.113	5.535	7.21	9.33	9.26	13.46	13.36	25.96	25.64	40.97	3.87	3.89
7.62 (300")	3.736	6.641	8.67	11.21	11.13	16.17	16.06	31.18	30.80	49.20	4.66	4.68
8.89 (350")	4.358	7.748	10.13	13.10	12.99	18.88	18.75	36.41	35.96	57.43	—	5.48
10.16 (400")	4.981	8.855	11.59	14.99	14.86	21.60	21.45	41.64	41.12	65.65	—	6.27
12.70 (500")	6.226	11.069	14.51	18.76	18.60	27.03	26.84	52.09	51.44	82.11	—	7.85
15.24 (600")	7.472	13.283	17.44	22.54	22.33	32.46	32.23	62.54	61.76	98.56	—	9.44
25.40 (1000")	12.453	22.138	29.12	37.63	37.28	54.17	53.79	104.36	103.05	164.38	—	15.78

*1 The throw ratio is based on the value during projection onto a 3.81 m (150") screen size.

■ When the screen aspect is 4:3

(Unit: m)

Lens type			Zoom lens											
Projection lens Model No.			ET-D75LE1		ET-D75LE2		ET-D75LE3		ET-D75LE4		ET-D75LE8		ET-D75LE6	
Throw ratio*1			1.6-2.2:1		2.2-3.3:1		3.3-5.5:1		5.6-8.9:1		8.8-16.5:1		1.1-1.3:1	
Projection screen size			Projection distance (L)											
Diagonal (SD)	Height (SH)	Width (SW)	Min. (LW)	Max. (LT)	Min. (LW)	Max. (LT)	Min. (LW)	Max. (LT)	Min. (LW)	Max. (LT)	Min. (LW)	Max. (LT)	Min. (LW)	Max. (LT)
1.78 (70")	1.067	1.422	2.29	3.06	3.09	4.65	4.66	7.83	7.83	12.54	12.25	23.32	1.54	1.84
2.03 (80")	1.219	1.626	2.63	3.51	3.55	5.33	5.34	8.96	8.97	14.34	14.06	26.71	1.77	2.11
2.29 (90")	1.372	1.829	2.96	3.96	4.00	6.01	6.02	10.10	10.10	16.15	15.87	30.09	2.00	2.38
2.54 (100")	1.524	2.032	3.30	4.41	4.45	6.69	6.70	11.23	11.24	17.96	17.67	33.47	2.22	2.66
3.05 (120")	1.829	2.438	3.98	5.32	5.36	8.05	8.06	13.50	13.51	21.57	21.28	40.24	2.68	3.20
3.81 (150")	2.286	3.048	4.99	6.67	6.72	10.09	10.10	16.91	16.92	26.98	26.70	50.39	3.36	4.02
5.08 (200")	3.048	4.064	6.68	8.93	8.99	13.49	13.50	22.59	22.59	36.01	35.73	67.31	4.50	5.39
6.35 (250")	3.810	5.080	8.37	11.18	11.25	16.89	16.90	28.27	28.27	45.04	44.76	84.23	5.64	6.76
7.62 (300")	4.572	6.096	10.06	13.44	13.52	20.29	20.30	33.94	33.95	54.07	53.79	101.14	6.78	8.12
8.89 (350")	5.334	7.112	11.75	15.70	15.79	23.69	23.70	39.62	39.63	63.10	62.82	118.06	7.92	9.49
10.16 (400")	6.096	8.128	13.44	17.96	18.05	27.09	27.10	45.30	45.31	72.13	71.85	134.98	9.06	10.85
12.70 (500")	7.620	10.160	16.82	22.47	22.58	33.89	33.90	56.65	56.66	90.18	89.91	168.81	11.34	13.58
15.24 (600")	9.144	12.192	20.20	26.98	27.12	40.69	40.70	68.01	68.02	108.24	107.96	202.65	13.62	16.32
25.40 (1000")	15.240	20.320	33.71	45.04	45.25	67.88	67.90	113.43	113.44	180.46	180.20	—	22.74	27.24

Lens type			Zoom lens								Fixed-focus lens	
Projection lens Model No.			ET-D75LE10		ET-D75LE20		ET-D75LE30		ET-D75LE40		ET-D75LE5	ET-D75LE50
Throw ratio*1			1.6-2.0:1		2.0-2.9:1		2.9-5.6:1		5.5-8.9:1		0.8:1	0.8:1
Projection screen size			Projection distance (L)									
Diagonal (SD)	Height (SH)	Width (SW)	Min. (LW)	Max. (LT)	Min. (LW)	Max. (LT)	Min. (LW)	Max. (LT)	Min. (LW)	Max. (LT)	Fixed	Fixed
1.78 (70")	1.067	1.422	2.17	2.80	2.80	4.07	4.04	7.88	7.80	12.52	1.13	1.15
2.03 (80")	1.219	1.626	2.49	3.22	3.21	4.67	4.64	9.03	8.94	14.34	1.31	1.33
2.29 (90")	1.372	1.829	2.81	3.63	3.62	5.27	5.23	10.19	10.07	16.15	1.48	1.50
2.54 (100")	1.524	2.032	3.13	4.05	4.03	5.86	5.82	11.34	11.21	17.96	1.66	1.67
3.05 (120")	1.829	2.438	3.77	4.88	4.86	7.06	7.01	13.64	13.48	21.59	2.00	2.02
3.81 (150")	2.286	3.048	4.74	6.13	6.09	8.85	8.79	17.09	16.89	27.02	2.53	2.55
5.08 (200")	3.048	4.064	6.35	8.21	8.15	11.84	11.76	22.85	22.58	36.09	3.40	3.42
6.35 (250")	3.810	5.080	7.96	10.28	10.20	14.83	14.73	28.61	28.26	45.15	4.27	4.29
7.62 (300")	4.572	6.096	9.56	12.36	12.26	17.82	17.70	34.36	33.94	54.21	5.14	5.17
8.89 (350")	5.334	7.112	11.17	14.44	14.32	20.81	20.67	40.12	39.63	63.27	—	6.04
10.16 (400")	6.096	8.128	12.78	16.52	16.38	23.80	23.63	45.88	45.31	72.33	—	6.91
12.70 (500")	7.620	10.16	16.00	20.68	20.49	29.78	29.57	57.39	56.68	90.45	—	8.66
15.24 (600")	9.144	12.192	19.21	24.83	24.61	35.76	35.51	68.91	68.05	108.58	—	10.40
25.40 (1000")	15.240	20.320	32.08	41.46	41.07	59.68	59.26	114.96	113.52	181.07	—	17.39

*1 The throw ratio is based on the value during projection onto a 3.81 m (150") screen size.

For PT-DS12KE

■ When the screen aspect is 4:3

(Unit: m)

Lens type			Zoom lens											
Projection lens Model No.			ET-D75LE1		ET-D75LE2		ET-D75LE3		ET-D75LE4		ET-D75LE8		ET-D75LE6	
Throw ratio*1			1.5-2.0:1		2.0-30:1		3.0-5.0:1		5.0-8.0:1		7.9-15.0:1		1.0-1.2:1	
Projection screen size			Projection distance (L)											
Diagonal (SD)	Height (SH)	Width (SW)	Min. (LW)	Max. (LT)	Min. (LW)	Max. (LT)	Min. (LW)	Max. (LT)	Min. (LW)	Max. (LT)	Min. (LW)	Max. (LT)	Min. (LW)	Max. (LT)
1.78 (70")	1.067	1.422	2.07	2.77	2.80	4.21	4.23	7.09	7.10	11.37	11.09	21.14	1.39	1.66
2.03 (80")	1.219	1.626	2.38	3.18	3.21	4.83	4.84	8.13	8.13	13.01	12.73	24.21	1.60	1.91
2.29 (90")	1.372	1.829	2.68	3.59	3.62	5.45	5.46	9.16	9.16	14.65	14.37	27.29	1.81	2.16
2.54 (100")	1.524	2.032	2.99	4.00	4.04	6.07	6.08	10.19	10.19	16.29	16.01	30.36	2.01	2.41
3.05 (120")	1.829	2.438	3.60	4.82	4.86	7.30	7.31	12.25	12.26	19.57	19.29	36.50	2.43	2.90
3.81 (150")	2.286	3.048	4.53	6.05	6.09	9.15	9.16	15.34	15.35	24.49	24.21	45.72	3.05	3.65
5.08 (200")	3.048	4.064	6.06	8.10	8.15	12.24	12.25	20.50	20.50	32.69	32.40	61.08	4.08	4.89
6.35 (250")	3.810	5.080	7.59	10.15	10.21	15.33	15.34	25.65	25.66	40.88	40.60	76.44	5.12	6.13
7.62 (300")	4.572	6.096	9.13	12.19	12.27	18.41	18.42	30.81	30.81	49.08	48.80	91.79	6.15	7.37
8.89 (350")	5.334	7.112	10.66	14.24	14.32	21.50	21.51	35.96	35.97	57.28	57.00	107.15	7.19	8.61
10.16 (400")	6.096	8.128	12.19	16.29	16.38	24.58	24.60	41.12	41.12	65.47	65.19	122.51	8.22	9.85
12.70 (500")	7.620	10.160	15.26	20.39	20.50	30.76	30.77	51.42	51.43	81.87	81.59	153.23	10.29	12.33
15.24 (600")	9.144	12.192	18.33	24.49	24.61	36.93	36.94	61.73	61.74	98.26	97.98	183.95	12.36	14.81
25.40 (1000")	15.240	20.320	30.60	40.88	41.07	61.62	61.63	102.97	102.98	163.83	163.56	—	20.64	24.73

Lens type			Zoom lens								Fixed-focus lens	
Projection lens Model No.			ET-D75LE10		ET-D75LE20		ET-D75LE30		ET-D75LE40		ET-D75LE5	ET-D75LE50
Throw ratio*1			1.4-1.8:1		1.8-2.6:1		2.6-5.1:1		5.0-8.0:1		0.8:1	0.8:1
Projection screen size			Projection distance (L)									
Diagonal (SD)	Height (SH)	Width (SW)	Min. (LW)	Max. (LT)	Min. (LW)	Max. (LT)	Min. (LW)	Max. (LT)	Min. (LW)	Max. (LT)	Fixed	Fixed
1.78 (70")	1.067	1.422	1.95	2.52	2.52	3.66	3.64	7.10	7.02	11.28	1.02	1.03
2.03 (80")	1.219	1.626	2.24	2.89	2.89	4.20	4.17	8.13	8.05	12.92	1.18	1.19
2.29 (90")	1.372	1.829	2.53	3.27	3.26	4.74	4.71	9.17	9.07	14.56	1.34	1.35
2.54 (100")	1.524	2.032	2.82	3.64	3.63	5.28	5.24	10.21	10.10	16.19	1.50	1.50
3.05 (120")	1.829	2.438	3.40	4.39	4.37	6.36	6.31	12.29	12.15	19.46	1.81	1.82
3.81 (150")	2.286	3.048	4.27	5.52	5.49	7.98	7.92	15.41	15.23	24.37	2.29	2.29
5.08 (200")	3.048	4.064	5.72	7.39	7.34	10.67	10.60	20.60	20.35	32.54	3.08	3.08
6.35 (250")	3.810	5.080	7.17	9.27	9.20	13.37	13.28	25.79	25.48	40.72	3.87	3.87
7.62 (300")	4.572	6.096	8.62	11.14	11.06	16.07	15.96	30.99	30.61	48.89	4.66	4.65
8.89 (350")	5.334	7.112	10.07	13.02	12.91	18.77	18.63	36.18	35.74	57.07	—	5.44
10.16 (400")	6.096	8.128	11.52	14.90	14.77	21.46	21.31	41.38	40.87	65.25	—	6.23
12.70 (500")	7.620	10.160	14.42	18.65	18.48	26.86	26.67	51.77	51.12	81.60	—	7.80
15.24 (600")	9.144	12.192	17.33	22.40	22.19	32.25	32.03	62.15	61.38	97.95	—	9.38
25.40 (1000")	15.240	20.320	28.93	37.40	37.05	53.83	53.45	103.71	102.41	163.36	—	15.68

*1 The throw ratio is based on the value during projection onto a 3.81 m (150") screen size.

■ When the screen aspect is 16:9

(Unit: m)

Lens type			Zoom lens											
Projection lens Model No.			ET-D75LE1		ET-D75LE2		ET-D75LE3		ET-D75LE4		ET-D75LE8		ET-D75LE6	
Throw ratio*1			1.5-2.0:1		2.0-30:1		3.0-5.0:1		5.0-8.0:1		8.0-15.0:1		1.0-1.2:1	
Projection screen size			Projection distance (L)											
Diagonal (SD)	Height (SH)	Width (SW)	Min. (LW)	Max. (LT)	Min. (LW)	Max. (LT)	Min. (LW)	Max. (LT)	Min. (LW)	Max. (LT)	Min. (LW)	Max. (LT)	Min. (LW)	Max. (LT)
1.78 (70")	0.872	1.550	2.26	3.02	3.06	4.60	4.61	7.74	7.75	12.40	12.12	23.06	1.52	1.82
2.03 (80")	0.996	1.771	2.60	3.47	3.51	5.27	5.28	8.86	8.87	14.18	13.90	26.41	1.75	2.09
2.29 (90")	1.121	1.992	2.93	3.92	3.95	5.95	5.96	9.99	9.99	15.97	15.69	29.76	1.97	2.36
2.54 (100")	1.245	2.214	3.27	4.36	4.40	6.62	6.63	11.11	11.11	17.76	17.47	33.10	2.20	2.63
3.05 (120")	1.494	2.657	3.93	5.26	5.30	7.96	7.97	13.35	13.36	21.33	21.04	39.79	2.65	3.17
3.81 (150")	1.868	3.321	4.94	6.60	6.64	9.98	9.99	16.72	16.73	26.68	26.40	49.83	3.33	3.98
5.08 (200")	2.491	4.428	6.61	8.83	8.89	13.34	13.35	22.34	22.34	35.61	35.33	66.56	4.45	5.33
6.35 (250")	3.113	5.535	8.28	11.06	11.13	16.70	16.71	27.95	27.96	44.54	44.26	83.29	5.58	6.68
7.62 (300")	3.736	6.641	9.95	13.29	13.37	20.07	20.08	33.57	33.57	53.47	53.19	100.02	6.71	8.03
8.89 (350")	4.358	7.748	11.62	15.52	15.61	23.43	23.44	39.18	39.19	62.40	62.12	116.75	7.84	9.38
10.16 (400")	4.981	8.855	13.29	17.76	17.85	26.79	26.80	44.80	44.80	71.33	71.05	133.48	8.96	10.73
12.70 (500")	6.226	11.069	16.63	22.22	22.33	33.51	33.52	56.03	56.03	89.19	88.91	166.95	11.22	13.43
15.24 (600")	7.472	13.283	19.97	26.69	26.82	40.24	40.25	67.26	67.26	107.04	106.77	200.41	13.47	16.14
25.40 (1000")	12.453	22.138	33.34	44.54	44.75	67.13	67.15	112.18	112.18	178.47	178.20	—	22.49	26.94

Lens type			Zoom lens								Fixed-focus lens	
Projection lens Model No.			ET-D75LE10		ET-D75LE20		ET-D75LE30		ET-D75LE40		ET-D75LE5	ET-D75LE50
Throw ratio*1			1.4-1.8:1		1.8-2.6:1		2.6-5.1:1		5.0-8.0:1		0.8:1	0.7:1
Projection screen size			Projection distance (L)									
Diagonal (SD)	Height (SH)	Width (SW)	Min. (LW)	Max. (LT)	Min. (LW)	Max. (LT)	Min. (LW)	Max. (LT)	Min. (LW)	Max. (LT)	Fixed	Fixed
1.78 (70")	0.872	1.550	2.13	2.75	2.75	4.00	3.97	7.74	7.66	12.31	1.12	1.13
2.03 (80")	0.996	1.771	2.44	3.16	3.15	4.59	4.55	8.88	8.78	14.09	1.29	1.30
2.29 (90")	1.121	1.992	2.76	3.57	3.56	5.17	5.14	10.01	9.90	15.87	1.47	1.47
2.54 (100")	1.245	2.214	3.08	3.98	3.96	5.76	5.72	11.14	11.01	17.65	1.64	1.64
3.05 (120")	1.494	2.657	3.71	4.79	4.77	6.94	6.89	13.40	13.25	21.21	1.98	1.99
3.81 (150")	1.868	3.321	4.66	6.02	5.98	8.70	8.64	16.80	16.60	26.56	2.5	2.50
5.08 (200")	2.491	4.428	6.24	8.06	8.01	11.64	11.56	22.46	22.19	35.46	3.36	3.36
6.35 (250")	3.113	5.535	7.82	10.11	10.03	14.58	14.47	28.11	27.77	44.37	4.22	4.22
7.62 (300")	3.736	6.641	9.40	12.15	12.05	17.51	17.39	33.77	33.36	53.27	5.08	5.08
8.89 (350")	4.358	7.748	10.98	14.19	14.07	20.45	20.31	39.43	38.95	62.18	—	5.93
10.16 (400")	4.981	8.855	12.56	16.23	16.10	23.39	23.23	45.09	44.53	71.09	—	6.79
12.70 (500")	6.226	11.069	15.72	20.32	20.14	29.27	29.06	56.40	55.70	88.90	—	8.51
15.24 (600")	7.472	13.283	18.88	24.41	24.18	35.15	34.90	67.72	66.88	106.71	—	10.22
25.40 (1000")	12.453	22.138	31.53	40.75	40.36	58.65	58.24	112.98	111.56	177.96	—	17.09

*1 The throw ratio is based on the value during projection onto a 3.81 m (150") screen size.

For PT-DW11KE

■ When the screen aspect is 16:9

(Unit: m)

Lens type			Zoom lens											
Projection lens Model No.			ET-D75LE1		ET-D75LE2		ET-D75LE3		ET-D75LE4		ET-D75LE8		ET-D75LE6	
Throw ratio*1			1.5-2.0:1		2.1-3.1:1		3.1-5.2:1		5.2-8.2:1		8.2-15.4:1		1.0-1.2:1	
Projection screen size			Projection distance (L)											
Diagonal (SD)	Height (SH)	Width (SW)	Min. (LW)	Max. (LT)	Min. (LW)	Max. (LT)	Min. (LW)	Max. (LT)	Min. (LW)	Max. (LT)	Min. (LW)	Max. (LT)	Min. (LW)	Max. (LT)
1.78 (70")	0.872	1.550	2.32	3.10	3.14	4.72	4.73	7.94	7.94	12.71	12.43	23.65	1.56	1.87
2.03 (80")	0.996	1.771	2.66	3.56	3.60	5.41	5.42	9.09	9.09	14.54	14.26	27.08	1.79	2.14
2.29 (90")	1.121	1.992	3.01	4.02	4.06	6.10	6.11	10.24	10.25	16.37	16.09	30.51	2.02	2.42
2.54 (100")	1.245	2.214	3.35	4.48	4.52	6.79	6.80	11.39	11.40	18.21	17.92	33.94	2.25	2.70
3.05 (120")	1.494	2.657	4.03	5.39	5.44	8.17	8.18	13.69	13.70	21.87	21.58	40.80	2.72	3.25
3.81 (150")	1.868	3.321	5.06	6.76	6.81	10.23	10.24	17.15	17.15	27.36	27.08	51.09	3.41	4.08
5.08 (200")	2.491	4.428	6.77	9.05	9.11	13.68	13.69	22.90	22.91	36.51	36.23	68.25	4.56	5.47
6.35 (250")	3.113	5.535	8.49	11.34	11.41	17.13	17.14	28.66	28.67	45.67	45.39	85.40	5.72	6.85
7.62 (300")	3.736	6.641	10.20	13.63	13.71	20.57	20.58	34.42	34.42	54.82	54.54	102.55	6.87	8.24
8.89 (350")	4.358	7.748	11.91	15.92	16.00	24.02	24.03	40.17	40.18	63.97	63.70	119.70	8.03	9.62
10.16 (400")	4.981	8.855	13.63	18.21	18.30	27.47	27.48	45.93	45.93	73.13	72.85	136.85	9.18	11.01
12.70 (500")	6.226	11.069	17.05	22.78	22.90	34.36	34.37	57.44	57.45	91.43	91.16	171.16	11.49	13.78
15.24 (600")	7.472	13.283	20.48	27.36	27.49	41.25	41.26	68.95	68.96	109.74	109.47	205.46	13.80	16.55
25.40 (1000")	12.453	22.138	34.18	45.67	45.88	68.83	68.84	115.00	115.01	182.97	182.70	—	23.04	27.63

Lens type			Zoom lens								Fixed-focus lens	
Projection lens Model No.			ET-D75LE10		ET-D75LE20		ET-D75LE30		ET-D75LE40		ET-D75LE5	ET-D75LE50
Throw ratio*1			1.4-1.9:1		1.8-2.7:1		2.7-5.2:1		5.1-8.2:1		0.8:1	0.8:1
Projection screen size			Projection distance (L)									
Diagonal (SD)	Height (SH)	Width (SW)	Min. (LW)	Max. (LT)	Min. (LW)	Max. (LT)	Min. (LW)	Max. (LT)	Min. (LW)	Max. (LT)	Fixed	Fixed
1.78 (70")	0.872	1.550	2.18	2.82	2.82	4.10	4.07	7.94	7.86	12.62	1.15	1.16
2.03 (80")	0.996	1.771	2.51	3.24	3.23	4.70	4.67	9.10	9.01	14.45	1.33	1.34
2.29 (90")	1.121	1.992	2.83	3.66	3.65	5.31	5.27	10.26	10.15	16.27	1.50	1.51
2.54 (100")	1.245	2.214	3.15	4.08	4.06	5.91	5.87	11.42	11.30	18.10	1.68	1.69
3.05 (120")	1.494	2.657	3.80	4.92	4.89	7.11	7.07	13.74	13.59	21.75	2.03	2.04
3.81 (150")	1.868	3.321	4.78	6.17	6.14	8.92	8.86	17.22	17.02	27.23	2.56	2.57
5.08 (200")	2.491	4.428	6.40	8.27	8.21	11.93	11.85	23.03	22.75	36.36	3.44	3.45
6.35 (250")	3.113	5.535	8.02	10.36	10.28	14.95	14.84	28.83	28.48	45.49	4.33	4.33
7.62 (300")	3.736	6.641	9.64	12.46	12.36	17.96	17.83	34.63	34.20	54.62	5.21	5.21
8.89 (350")	4.358	7.748	11.26	14.55	14.43	20.97	20.82	40.43	39.93	63.75	—	6.09
10.16 (400")	4.981	8.855	12.88	16.65	16.50	23.98	23.81	46.23	45.66	72.88	—	6.96
12.70 (500")	6.226	11.069	16.12	20.83	20.65	30.01	29.80	57.83	57.11	91.14	—	8.72
15.24 (600")	7.472	13.283	19.36	25.02	24.80	36.03	35.78	69.43	68.56	109.40	—	10.48
25.40 (1000")	12.453	22.138	32.32	41.78	41.38	60.13	59.70	115.83	114.38	182.44	—	17.52

*1 The throw ratio is based on the value during projection onto a 3.81 m (150") screen size.

■ When the screen aspect is 4:3

(Unit: m)

Lens type			Zoom lens											
Projection lens Model No.			ET-D75LE1		ET-D75LE2		ET-D75LE3		ET-D75LE4		ET-D75LE8		ET-D75LE6	
Throw ratio*1			2.0-2.7:1		2.7-4.1:1		4.1-6.9:1		6.9-11.0:1		10.9-20.5:1		1.4-1.6:1	
Projection screen size			Projection distance (L)											
Diagonal (SD)	Height (SH)	Width (SW)	Min. (LW)	Max. (LT)	Min. (LW)	Max. (LT)	Min. (LW)	Max. (LT)	Min. (LW)	Max. (LT)	Min. (LW)	Max. (LT)	Min. (LW)	Max. (LT)
1.78 (70")	1.067	1.422	2.86	3.82	3.86	5.80	5.81	9.74	9.75	15.59	15.30	29.04	1.92	2.30
2.03 (80")	1.219	1.626	3.28	4.38	4.42	6.65	6.66	11.15	11.16	17.83	17.55	33.24	2.21	2.64
2.29 (90")	1.372	1.829	3.70	4.94	4.98	7.49	7.50	12.56	12.57	20.07	19.79	37.44	2.49	2.98
2.54 (100")	1.524	2.032	4.12	5.50	5.55	8.33	8.34	13.97	13.98	22.31	22.03	41.64	2.77	3.32
3.05 (120")	1.829	2.438	4.96	6.62	6.67	10.02	10.03	16.79	16.80	26.79	26.51	50.04	3.34	4.00
3.81 (150")	2.286	3.048	6.21	8.30	8.36	12.55	12.56	21.02	21.03	33.52	33.24	62.64	4.19	5.01
5.08 (200")	3.048	4.064	8.31	11.11	11.17	16.77	16.78	28.07	28.07	44.72	44.44	83.63	5.60	6.71
6.35 (250")	3.810	5.080	10.41	13.91	13.99	20.99	21.00	35.12	35.12	55.93	55.65	104.63	7.01	8.40
7.62 (300")	4.572	6.096	12.51	16.71	16.80	25.21	25.22	42.16	42.17	67.14	66.86	125.63	8.43	10.10
8.89 (350")	5.334	7.112	14.60	19.51	19.61	29.43	29.44	49.21	49.22	78.34	78.07	146.63	9.84	11.80
10.16 (400")	6.096	8.128	16.70	22.31	22.43	33.65	33.66	56.26	56.26	89.55	89.28	167.63	11.26	13.49
12.70 (500")	7.620	10.160	20.89	27.92	28.05	42.09	42.10	70.35	70.36	111.96	111.69	209.62	14.08	16.88
15.24 (600")	9.144	12.192	25.09	33.52	33.68	50.53	50.54	84.45	84.45	134.38	134.11	251.62	16.91	20.27
25.40 (1000")	15.240	20.320	41.86	55.93	56.18	84.29	84.30	140.83	140.83	224.03	223.77	—	28.22	33.84

Lens type			Zoom lens								Fixed-focus lens	
Projection lens Model No.			ET-D75LE10		ET-D75LE20		ET-D75LE30		ET-D75LE40		ET-D75LE5	ET-D75LE50
Throw ratio*1			1.9-2.5:1		2.5-3.6:1		3.6-6.9:1		6.8-10.9:1		1.0:1	1.0:1
Projection screen size			Projection distance (L)									
Diagonal (SD)	Height (SH)	Width (SW)	Min. (LW)	Max. (LT)	Min. (LW)	Max. (LT)	Min. (LW)	Max. (LT)	Min. (LW)	Max. (LT)	Fixed	Fixed
1.78 (70")	1.067	1.422	2.69	3.48	3.47	5.05	5.01	9.77	9.66	15.49	1.43	1.44
2.03 (80")	1.219	1.626	3.09	3.99	3.98	5.78	5.75	11.19	11.06	17.72	1.64	1.65
2.29 (90")	1.372	1.829	3.49	4.51	4.49	6.52	6.48	12.61	12.46	19.96	1.86	1.87
2.54 (100")	1.524	2.032	3.88	5.02	4.99	7.26	7.21	14.03	13.86	22.19	2.08	2.08
3.05 (120")	1.829	2.438	4.68	6.05	6.01	8.74	8.68	16.87	16.67	26.67	2.51	2.51
3.81 (150")	2.286	3.048	5.87	7.58	7.53	10.95	10.87	21.13	20.88	33.37	3.16	3.16
5.08 (200")	3.048	4.064	7.85	10.15	10.07	14.64	14.53	28.23	27.89	44.55	4.24	4.24
6.35 (250")	3.810	5.080	9.83	12.71	12.61	18.32	18.20	35.33	34.90	55.73	5.32	5.31
7.62 (300")	4.572	6.096	11.82	15.28	15.15	22.01	21.86	42.43	41.91	66.91	6.40	6.39
8.89 (350")	5.334	7.112	13.80	17.84	17.68	25.70	25.52	49.53	48.92	78.08	—	7.47
10.16 (400")	6.096	8.128	15.78	20.40	20.22	29.39	29.18	56.64	55.93	89.26	—	8.54
12.70 (500")	7.620	10.160	19.75	25.53	25.30	36.76	36.50	70.84	69.95	111.62	—	10.70
15.24 (600")	9.144	12.192	23.72	30.66	30.38	44.14	43.83	85.04	83.98	133.97	—	12.85
25.40 (1000")	15.240	20.320	39.59	51.17	50.68	73.64	73.12	141.85	140.07	223.40	—	21.46

*1 The throw ratio is based on the value during projection onto a 3.81 m (150") screen size.

Formula to calculate projection distance per projection lens

To use a screen size not listed in this manual, check the screen size SD (m) and use the respective formula to calculate projection distance. The unit of all the formulae is m. (Values obtained by the following calculation formulae contain a slight error.)

For PT-DZ13KE, PT-DZ10KE

■ **Zoom lens**

Projection lens Model No.	Throw ratio	Aspect ratio	Projection distance (L) formula	
ET-D75LE1	1.4 to 1.8:1	16:10	Min. (LW)	$L = 1.1732 \times SD - 0.0760$
			Max. (LT)	$L = 1.5709 \times SD - 0.1004$
	1.4 to 1.8:1	16:9	Min. (LW)	$L = 1.2087 \times SD - 0.0760$
			Max. (LT)	$L = 1.6142 \times SD - 0.1004$
	1.6 to 2.2:1	4:3	Min. (LW)	$L = 1.3307 \times SD - 0.0760$
			Max. (LT)	$L = 1.7756 \times SD - 0.1004$
ET-D75LE2	1.8 to 2.8:1	16:10	Min. (LW)	$L = 1.5748 \times SD - 0.0795$
			Max. (LT)	$L = 2.3661 \times SD - 0.1064$
	1.8 to 2.8:1	16:9	Min. (LW)	$L = 1.6220 \times SD - 0.0795$
			Max. (LT)	$L = 2.4291 \times SD - 0.1064$
	2.2 to 3.3:1	4:3	Min. (LW)	$L = 1.7835 \times SD - 0.0795$
			Max. (LT)	$L = 2.6772 \times SD - 0.1064$
ET-D75LE3	2.8 to 4.6:1	16:10	Min. (LW)	$L = 2.3661 \times SD - 0.0958$
			Max. (LT)	$L = 3.9488 \times SD - 0.1216$
	2.8 to 4.6:1	16:9	Min. (LW)	$L = 2.4291 \times SD - 0.0958$
			Max. (LT)	$L = 4.0591 \times SD - 0.1216$
	3.3 to 5.5:1	4:3	Min. (LW)	$L = 2.6772 \times SD - 0.0958$
			Max. (LT)	$L = 4.4724 \times SD - 0.1216$
ET-D75LE4	4.6 to 7.4:1	16:10	Min. (LW)	$L = 3.9488 \times SD - 0.1158$
			Max. (LT)	$L = 6.2795 \times SD - 0.1013$
	4.6 to 7.4:1	16:9	Min. (LW)	$L = 4.0591 \times SD - 0.1158$
			Max. (LT)	$L = 6.4528 \times SD - 0.1013$
	5.6 to 8.9:1	4:3	Min. (LW)	$L = 4.4724 \times SD - 0.1158$
			Max. (LT)	$L = 7.1102 \times SD - 0.1013$
ET-D75LE8	7.3 to 13.8:1	16:10	Min. (LW)	$L = 6.2795 \times SD - 0.3862$
			Max. (LT)	$L = 11.7677 \times SD - 0.3598$
	7.3 to 13.8:1	16:9	Min. (LW)	$L = 6.4567 \times SD - 0.3862$
			Max. (LT)	$L = 12.0945 \times SD - 0.3598$
	8.8 to 16.5:1	4:3	Min. (LW)	$L = 7.1102 \times SD - 0.3862$
			Max. (LT)	$L = 13.3189 \times SD - 0.3598$
ET-D75LE6	0.9 to 1.1:1	16:10	Min. (LW)	$L = 0.7913 \times SD - 0.0566$
			Max. (LT)	$L = 0.9488 \times SD - 0.0736$
	0.9 to 1.1:1	16:9	Min. (LW)	$L = 0.8150 \times SD - 0.0566$
			Max. (LT)	$L = 0.9764 \times SD - 0.0736$
	1.1 to 1.3:1	4:3	Min. (LW)	$L = 0.8976 \times SD - 0.0566$
			Max. (LT)	$L = 1.0748 \times SD - 0.0736$
ET-D75LE10	1.3 to 1.7:1	16:10	Min. (LW)	$L = 1.1186 \times SD - 0.0857$
			Max. (LT)	$L = 1.4458 \times SD - 0.1085$
	1.3 to 1.7:1	16:9	Min. (LW)	$L = 1.1497 \times SD - 0.0857$
			Max. (LT)	$L = 1.4860 \times SD - 0.1085$
	1.6 to 2.0:1	4:3	Min. (LW)	$L = 1.2663 \times SD - 0.0857$
			Max. (LT)	$L = 1.6367 \times SD - 0.1085$
ET-D75LE20	1.7 to 2.4:1	16:10	Min. (LW)	$L = 1.4312 \times SD - 0.0832$
			Max. (LT)	$L = 2.0795 \times SD - 0.1162$
	1.7 to 2.4:1	16:9	Min. (LW)	$L = 1.4709 \times SD - 0.0832$
			Max. (LT)	$L = 2.1373 \times SD - 0.1162$
	2.0 to 2.9:1	4:3	Min. (LW)	$L = 1.6202 \times SD - 0.0832$
			Max. (LT)	$L = 2.3542 \times SD - 0.1162$

Chapter 2 Getting Started — Setting up

Projection lens Model No.	Throw ratio	Aspect ratio	Projection distance (L) formula	
ET-D75LE30	2.4 to 4.7:1	16:10	Min. (LW)	$L = 2.0647 \times SD - 0.1131$
			Max. (LT)	$L = 4.0041 \times SD - 0.1765$
	2.4 to 4.7:1	16:9	Min. (LW)	$L = 2.1221 \times SD - 0.1131$
			Max. (LT)	$L = 4.1155 \times SD - 0.1765$
	2.9 to 5.6:1	4:3	Min. (LW)	$L = 2.3374 \times SD - 0.1131$
			Max. (LT)	$L = 4.5330 \times SD - 0.1765$
ET-D75LE40	4.6 to 7.4:1	16:10	Min. (LW)	$L = 3.9532 \times SD - 0.1577$
			Max. (LT)	$L = 6.3027 \times SD - 0.1615$
	4.6 to 7.4:1	16:9	Min. (LW)	$L = 4.0631 \times SD - 0.1577$
			Max. (LT)	$L = 6.4779 \times SD - 0.1615$
	5.5 to 8.9:1	4:3	Min. (LW)	$L = 4.4754 \times SD - 0.1577$
			Max. (LT)	$L = 7.1351 \times SD - 0.1615$

■ Fixed-focus lens

Projection lens Model No.	Throw ratio	Aspect ratio	Projection distance (L) formula	
ET-D75LE5	0.7:1	16:10	$L = 0.6063 \times SD - 0.0835$	
	0.7:1	16:9	$L = 0.6220 \times SD - 0.0835$	
	0.8:1	4:3	$L = 0.6850 \times SD - 0.0835$	
ET-D75LE50	0.7:1	16:10	$L = 0.6072 \times SD - 0.0713$	
	0.7:1	16:9	$L = 0.6240 \times SD - 0.0713$	
	0.8:1	4:3	$L = 0.6873 \times SD - 0.0713$	

For PT-DS12KE

■ Zoom lens

Projection lens Model No.	Throw ratio	Aspect ratio	Projection distance (L) formula	
ET-D75LE1	1.5 to 2.0:1	4:3	Min. (LW)	$L = 1.2087 \times SD - 0.0760$
			Max. (LT)	$L = 1.6142 \times SD - 0.1004$
		16:9	Min. (LW)	$L = 1.3150 \times SD - 0.0760$
			Max. (LT)	$L = 1.7559 \times SD - 0.1004$
ET-D75LE2	2.0 to 3.0:1	4:3	Min. (LW)	$L = 1.6220 \times SD - 0.0795$
			Max. (LT)	$L = 2.4291 \times SD - 0.1064$
		16:9	Min. (LW)	$L = 1.7638 \times SD - 0.0795$
			Max. (LT)	$L = 2.6457 \times SD - 0.1064$
ET-D75LE3	3.0 to 5.0:1	4:3	Min. (LW)	$L = 2.4291 \times SD - 0.0958$
			Max. (LT)	$L = 4.0591 \times SD - 0.1216$
		16:9	Min. (LW)	$L = 2.6457 \times SD - 0.0958$
			Max. (LT)	$L = 4.4213 \times SD - 0.1216$
ET-D75LE4	5.0 to 8.0:1	4:3	Min. (LW)	$L = 4.0591 \times SD - 0.1158$
			Max. (LT)	$L = 6.4528 \times SD - 0.1013$
		16:9	Min. (LW)	$L = 4.4213 \times SD - 0.1158$
			Max. (LT)	$L = 7.0315 \times SD - 0.1013$
ET-D75LE8	7.9 to 15.0:1	4:3	Min. (LW)	$L = 6.4567 \times SD - 0.3862$
			Max. (LT)	$L = 12.0945 \times SD - 0.3598$
	8.0 to 15.0:1	16:9	Min. (LW)	$L = 7.0315 \times SD - 0.3862$
			Max. (LT)	$L = 13.1732 \times SD - 0.3598$
ET-D75LE6	1.0 to 1.2:1	4:3	Min. (LW)	$L = 0.8150 \times SD - 0.0566$
			Max. (LT)	$L = 0.9764 \times SD - 0.0736$
		16:9	Min. (LW)	$L = 0.8858 \times SD - 0.0566$
			Max. (LT)	$L = 1.0630 \times SD - 0.0736$
ET-D75LE10	1.4 to 1.8:1	4:3	Min. (LW)	$L = 1.1425 \times SD - 0.0857$
			Max. (LT)	$L = 1.4767 \times SD - 0.1085$
		16:9	Min. (LW)	$L = 1.2446 \times SD - 0.0857$
			Max. (LT)	$L = 1.6086 \times SD - 0.1085$

Chapter 2 Getting Started — Setting up

Projection lens Model No.	Throw ratio	Aspect ratio	Projection distance (L) formula	
ET-D75LE20	1.8 to 2.6:1	4:3	Min. (LW)	$L = 1.4618 \times SD - 0.0832$
			Max. (LT)	$L = 2.1241 \times SD - 0.1162$
		16:9	Min. (LW)	$L = 1.5924 \times SD - 0.0832$
			Max. (LT)	$L = 2.3137 \times SD - 0.1162$
ET-D75LE30	2.6 to 5.1:1	4:3	Min. (LW)	$L = 2.1089 \times SD - 0.1131$
			Max. (LT)	$L = 4.0899 \times SD - 0.1765$
		16:9	Min. (LW)	$L = 2.2972 \times SD - 0.1131$
			Max. (LT)	$L = 4.4552 \times SD - 0.1765$
ET-D75LE40	5.0 to 8.0:1	4:3	Min. (LW)	$L = 4.0379 \times SD - 0.1577$
			Max. (LT)	$L = 6.4377 \times SD - 0.1615$
		16:9	Min. (LW)	$L = 4.3985 \times SD - 0.1577$
			Max. (LT)	$L = 7.0126 \times SD - 0.1615$

■ Fixed-focus lens

Projection lens Model No.	Throw ratio	Aspect ratio	Projection distance (L) formula	
ET-D75LE5	0.8:1	4:3	$L = 0.6220 \times SD - 0.0835$	
		16:9	$L = 0.6772 \times SD - 0.0835$	
ET-D75LE50	0.8:1	4:3	$L = 0.6202 \times SD - 0.0713$	
		16:9	$L = 0.6755 \times SD - 0.0713$	

For PT-DW11KE

■ Zoom lens

Projection lens Model No.	Throw ratio	Aspect ratio	Projection distance (L) formula	
ET-D75LE1	1.5 to 2.0:1	16:9	Min. (LW)	$L = 1.3504 \times SD - 0.0760$
			Max. (LT)	$L = 1.8031 \times SD - 0.1004$
	2.0 to 2.7:1	4:3	Min. (LW)	$L = 1.6496 \times SD - 0.0760$
			Max. (LT)	$L = 2.2047 \times SD - 0.1004$
ET-D75LE2	2.1 to 3.1:1	16:9	Min. (LW)	$L = 1.8110 \times SD - 0.0795$
			Max. (LT)	$L = 2.7126 \times SD - 0.1064$
	2.7 to 4.1:1	4:3	Min. (LW)	$L = 2.2165 \times SD - 0.0795$
			Max. (LT)	$L = 3.3228 \times SD - 0.1064$
ET-D75LE3	3.1 to 5.2:1	16:9	Min. (LW)	$L = 2.7126 \times SD - 0.0958$
			Max. (LT)	$L = 4.5315 \times SD - 0.1216$
	4.1 to 6.9:1	4:3	Min. (LW)	$L = 3.3228 \times SD - 0.0958$
			Max. (LT)	$L = 5.5472 \times SD - 0.1216$
ET-D75LE4	5.2 to 8.2:1	16:9	Min. (LW)	$L = 4.5315 \times SD - 0.1158$
			Max. (LT)	$L = 7.2087 \times SD - 0.1013$
	6.9 to 11.0:1	4:3	Min. (LW)	$L = 5.5472 \times SD - 0.1158$
			Max. (LT)	$L = 8.8228 \times SD - 0.1013$
ET-D75LE8	8.2 to 15.4:1	16:9	Min. (LW)	$L = 7.2087 \times SD - 0.3862$
			Max. (LT)	$L = 13.5039 \times SD - 0.3598$
	10.9 to 20.5:1	4:3	Min. (LW)	$L = 8.8228 \times SD - 0.3862$
			Max. (LT)	$L = 16.5354 \times SD - 0.3598$
ET-D75LE6	1.0 to 1.2:1	16:9	Min. (LW)	$L = 0.9094 \times SD - 0.0566$
			Max. (LT)	$L = 1.0906 \times SD - 0.0736$
	1.4 to 1.6:1	4:3	Min. (LW)	$L = 1.1142 \times SD - 0.0566$
			Max. (LT)	$L = 1.3346 \times SD - 0.0736$
ET-D75LE10	1.4 to 1.9:1	16:9	Min. (LW)	$L = 1.2759 \times SD - 0.0857$
			Max. (LT)	$L = 1.6491 \times SD - 0.1085$
	1.9 to 2.5:1	4:3	Min. (LW)	$L = 1.5620 \times SD - 0.0857$
			Max. (LT)	$L = 2.0190 \times SD - 0.1085$

Projection lens Model No.	Throw ratio	Aspect ratio	Projection distance (L) formula	
ET-D75LE20	1.8 to 2.7:1	16:9	Min. (LW)	$L = 1.6324 \times SD - 0.0832$
			Max. (LT)	$L = 2.3720 \times SD - 0.1162$
	2.5 to 3.6:1	4:3	Min. (LW)	$L = 1.9986 \times SD - 0.0832$
			Max. (LT)	$L = 2.9040 \times SD - 0.1162$
ET-D75LE30	2.7 to 5.2:1	16:9	Min. (LW)	$L = 2.3550 \times SD - 0.1131$
			Max. (LT)	$L = 4.5673 \times SD - 0.1765$
	3.6 to 6.9:1	4:3	Min. (LW)	$L = 2.8833 \times SD - 0.1131$
			Max. (LT)	$L = 5.5917 \times SD - 0.1765$
ET-D75LE40	5.1 to 8.2:1	16:9	Min. (LW)	$L = 4.5092 \times SD - 0.1577$
			Max. (LT)	$L = 7.1891 \times SD - 0.1615$
	6.8 to 10.9:1	4:3	Min. (LW)	$L = 5.5206 \times SD - 0.1577$
			Max. (LT)	$L = 8.8016 \times SD - 0.1615$

■ Fixed-focus lens

Projection lens Model No.	Throw ratio	Aspect ratio	Projection distance (L) formula
ET-D75LE5	0.8:1	16:9	$L = 0.6929 \times SD - 0.0835$
	1.0:1	4:3	$L = 0.8504 \times SD - 0.0835$
ET-D75LE50	0.8:1	16:9	$L = 0.6925 \times SD - 0.0713$
	1.0:1	4:3	$L = 0.8479 \times SD - 0.0713$

Adjusting adjustable feet

Install the projector on a flat surface so that the front of the projector is parallel to the screen surface and the projection screen is rectangular. If the screen is tilted downward, the projection screen can be adjusted to be rectangular by adjusting the front adjustable feet. The adjustable feet can also be used to adjust the projector to be level when it is tilted in the horizontal direction.

Extend the adjustable feet by rotating in the direction shown in the figure and retract by rotating in the opposite direction.

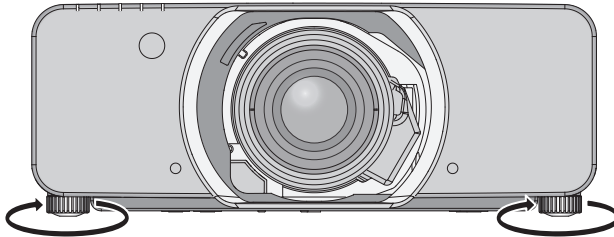

Adjustable amount

Front adjustable feet: Approx. 50 mm (1-31/32")
 Rear adjustable feet: Approx. 10 mm (13/32")

Attention

- Heated air is expelled from the air exhaust port while the lamp is lit. Do not touch the air exhaust port directly when adjusting the adjustable feet. (➔ page 25)

Attaching/removing the projection lens (optional)

Move the projection lens to the home position before replacing or removing the projection lens. (→ page 57)

Attention

- Replace the projection lens after turning off the power of the projector.
- Do not touch the lens signal receiver. Dust or dirt may cause defective contact.
- Do not touch the surface of the projection lens with your bare hands.
- Before attaching the projection lens, remove the lens cover attached to the projection lens.

Attaching the projection lens

Attach the projection lens using the following procedure.

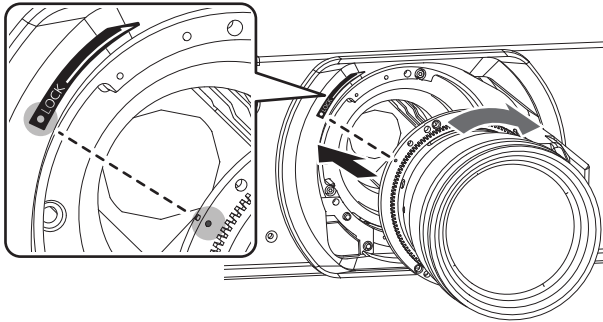

Fig. 1

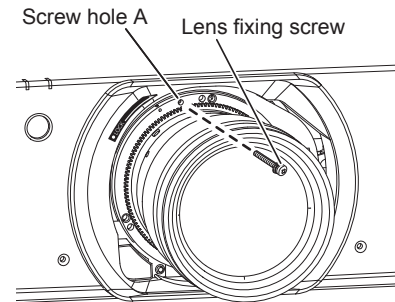

Fig. 2

- 1) **Insert by aligning the projection lens mark (orange) with the mark on the projector body (○ to the left of LOCK) and turn clockwise until it clicks. (Fig. 1)**
- 2) **Secure the projection lens with the lens fixing screw supplied. (Fig. 2)**
 - Use a Phillips screwdriver to secure it in the screw hole A to the right of the projection lens mark (orange).

Note

- Some lenses may not have a screw hole for securing the projection lens.

Attention

- Turn the projection lens counterclockwise to confirm that it does not come out.
- Store the removed dust sponge in a safe place to transport or store.

Removing the projection lens

Remove the projection lens using the following procedure.

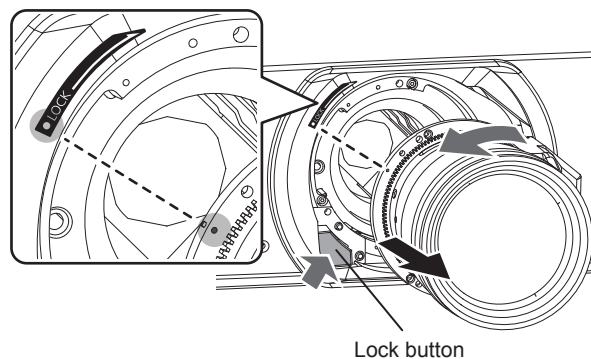

- 1) **Remove the lens fixing screw.**
 - Use a Phillips screwdriver to remove the first screw to the right of the projection lens mark (orange).
- 2) **While pressing the lock button, turn the projection lens counterclockwise to remove.**
 - Turn counterclockwise until the projection lens mark (orange) is at the mark on the projector body (○ to the left of LOCK).

Note

- Some lenses may not have a screw hole to use to secure the projection lens.

Attention

- Store the removed projection lens where it will be free from vibration and impact.
- Store the removed lens fixing screw in a safe place.

Connecting

Before connecting

- Before connecting, carefully read the operating instructions for the external device to be connected.
- Turn off the power of all devices before connecting cables.
- Take note of the following points before connecting the cables. Failure to do so may result in malfunctions.
 - When connecting a cable to a device connected to the projector or the projector itself, touch any nearby metallic objects to eliminate static electricity from your body before performing work.
 - Do not use unnecessarily long cables to connect to a device connected to the projector or to the projector body. The longer the cable, the more it is susceptible to noise. Since using a cable while it is wound makes it act like an antenna, it is more susceptible to noise.
 - When connecting cables, connect GND first, then insert the connecting terminal of the connecting device in a straight manner.
- Acquire any connection cable necessary to connect the external device to the system that is neither supplied with the device nor available as an option.
- Video signals containing too much jitter may cause the images on the screen to randomly wobble or wafture. In this case, a time base corrector (TBC) must be connected.
- The projector accepts video signals (including Y/C signals), analog RGB signals (synchronous signals are TTL level), and digital signals.
- Some computer models are not compatible with the projector.
- Use a cable compensator when you connect devices to the projector using long cables. Otherwise the image may not display properly.
- Refer to “List of compatible signals” (➔ page 177) for the types of video signals that can be used with the projector.

<RGB 2 IN> terminal pin assignments and signal names

Outside view	Pin No.	Signal name	Pin No.	Signal name
	(1)	R/P _R	(9)	—
	(2)	G/Y	(10)	GND
	(3)	B/P _B	(11)	GND
	(4)	—	(12)	DDC data
	(5)	GND	(13)	SYNC/HD
	(6)	GND	(14)	VD
	(7)	GND	(15)	DDC clock
	(8)	GND		

<HDMI IN> terminal pin assignments and signal names

Outside view	Pin No.	Signal name	Pin No.	Signal name
	(1)	T.M.D.S data 2+	(11)	T.M.D.S clock shield
	(2)	T.M.D.S data 2 shield	(12)	T.M.D.S clock-
	(3)	T.M.D.S data 2-	(13)	CEC
	(4)	T.M.D.S data 1+	(14)	—
	(5)	T.M.D.S data 1 shield	(15)	SCL
	(6)	T.M.D.S data 1-	(16)	SDA
	(7)	T.M.D.S data 0+	(17)	DDC/CEC GND
	(8)	T.M.D.S data 0 shield	(18)	+5 V
	(9)	T.M.D.S data 0-	(19)	Hot plug detection
	(10)	T.M.D.S clock+		

<DVI-D IN> terminal pin assignments and signal names

Outside view	Pin No.	Signal name	Pin No.	Signal name
	(1)	T.M.D.S data 2-	(13)	—
	(2)	T.M.D.S data 2+	(14)	+5 V
	(3)	T.M.D.S data 2/4 shield	(15)	GND
	(4)	—	(16)	Hot plug detection
	(5)	—	(17)	T.M.D.S data 0-
	(6)	DDC clock	(18)	T.M.D.S data 0+
	(7)	DDC data	(19)	T.M.D.S data 0/5 shield
	(8)	—	(20)	—
	(9)	T.M.D.S data 1-	(21)	—
	(10)	T.M.D.S clock1+	(22)	T.M.D.S clock shield
	(11)	T.M.D.S data 1/3 shield	(23)	T.M.D.S clock+
	(12)	—	(24)	T.M.D.S clock-

Connecting example: AV equipment

For <HDMI IN>/<DVI-D IN>/<VIDEO IN> terminals

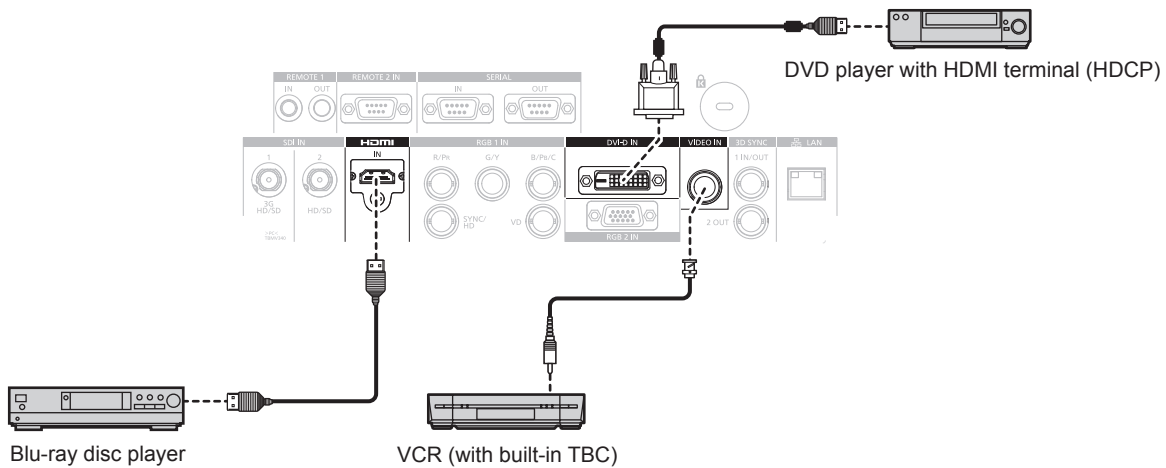

Attention

- Always use one of the following when connecting a VCR.
 - A VCR with built-in time base corrector (TBC)
 - A time base corrector (TBC) between the projector and the VCR
- If nonstandard burst signals are connected, the image may be distorted. In such case, connect the time base corrector (TBC) between the projector and the external devices.

Note

- When entering DVI-D, some external devices to be connected may require switching the setting using the [DISPLAY OPTION] menu → [DVI-D IN] → [EDID].
- The <DVI-D IN> terminal can be connected to HDMI- or DVI-D-compliant devices. However, images may not appear or may not be displayed properly on some devices.
- For an HDMI cable, use an HDMI High Speed cable that conforms to HDMI standards. If a cable that does not conform to HDMI standards is used, images may be interrupted or may not be displayed.
- The <HDMI IN> terminal of the projector can be connected to an external device with a DVI-D terminal by using an HDMI/DVI conversion cable, but some devices may not project the image properly or function properly.
- The projector does not support VIERA Link (HDMI).

For <SDI IN 1>/<SDI IN 2> terminals (PT-DZ13KE, PT-DS12KE), <SDI IN> terminal (PT-DZ10KE)

The connection example is for PT-DZ13KE, PT-DS12KE.

Digital VCR for commercial use

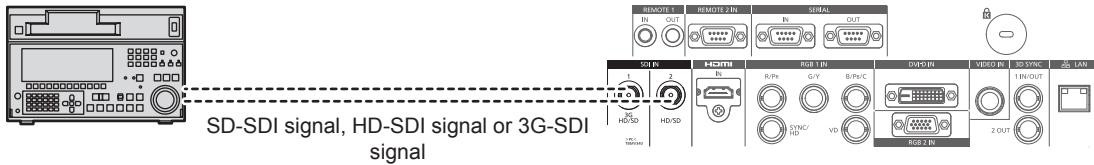

Note

- Use the [PICTURE] menu → [SYSTEM SELECTOR] to switch the input format.
- Some external devices to be connected require the [DISPLAY OPTION] menu → [SDI IN] to be set.
- Use a 5CFB or higher (such as 5CFB, or 7CFB) or a Belden 1694A or higher connection cable to properly transmit images. Use a connection cable of 100 m (328'1") length or less.
- To enter dual link signals, the [SDI LINK] in [SDI IN] must be set. (Only for PT-DZ13KE, PT-DS12KE)
- Use the same length and same type of cables to connect <SDI IN 1>/<SDI IN 2> terminals when entering dual link signals. If there is a difference of 4 m (13'1") or greater in cable length, images may not be projected properly. (Only for PT-DZ13KE, PT-DS12KE)
- To input dual link signals, connect directly without going through a distributor or other such device to the external device which outputs signals. A phase difference may occur between the LINK-A signal and the LINK-B signal and images may not be projected properly. (Only for PT-DZ13KE, PT-DS12KE)
- When an unsteady signal is connected, an error in signal detection may occur. In such a case, use the [PICTURE] menu → [SYSTEM SELECTOR] to switch to a system that matches the signal format.

Connecting example: Computers

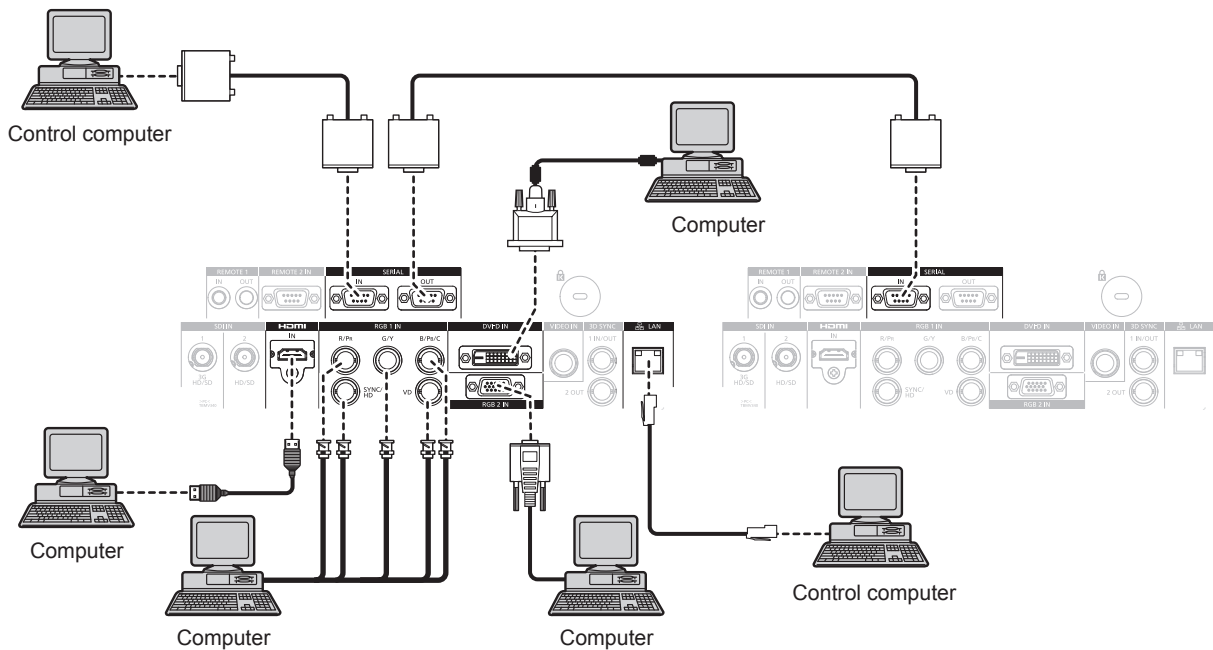

Attention

- When connecting the projector to a computer or an external device, use the power cord supplied with each device and commercially available shielded cables.
- Use a commercial cable with a ferrite core for connecting with the <DVI-D IN> terminal.

Note

- When entering DVI-D, some external devices to be connected may require switching the setting using the [DISPLAY OPTION] menu → [DVI-D IN] → [EDID].
- For an HDMI cable, use an HDMI High Speed cable that conforms to HDMI standards. If a cable that does not conform to HDMI standards is used, images may be interrupted or may not be displayed.
- The <HDMI IN> terminal of the projector can be connected to an external device with a DVI-D terminal by using an HDMI/DVI conversion cable, but some devices may not project the image properly or function properly.
- The <DVI-D IN> terminal supports single links only.
- When entering the SYNC ON GREEN signal, do not enter sync signals to the <SYNC/HD> terminal or the <VD> terminal.
- If you operate the projector using the computer with the resume feature (last memory), you may have to reset the resume feature to operate the projector.

Chapter 3 Basic Operations

This chapter describes basic operations to start with.

Switching on/off the projector

Connecting the power cord

Make sure that the supplied power cord is securely fixed to the projector body to prevent it from being removed easily.

Confirm that the <MAIN POWER> switch is on the <OFF> side before connecting the power cord.

For details of power cord handling, refer to “Read this first!” (➔ page 2).

Attaching the power cord

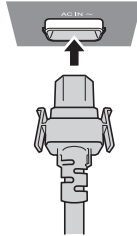

- 1) Check the shapes of the <AC IN> terminal on the side of the projector body and the power cord connector and insert the plug completely in the correct direction (until you hear the side tabs click in place).

Removing the power cord

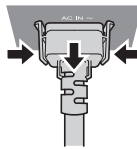

- 1) Confirm that the <MAIN POWER> switch on the side of the projector body is on the <OFF> side, and remove the power plug from the outlet.
- 2) Remove the power cord connector from the <AC IN> terminal of the projector body while pressing the side tabs.

Power indicator

Displays the status of the power. Check the <ON (G)/STANDBY (R)> status of the power indicator before operating the projector.

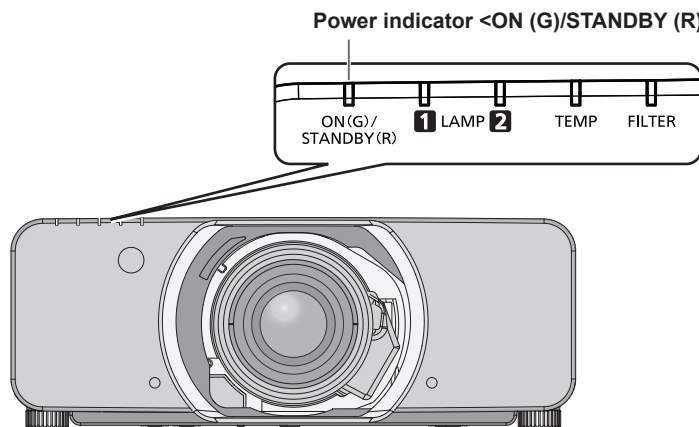

Indicator status		Projector status
Off		The main power is switched off.
Red	Lit	The power is switched off (in standby mode). Projection will start when the power on < > button is pressed. • The projector may not operate when the lamp indicators <LAMP1>/<LAMP2> or temperature indicator <TEMP> are flashing. (➔ page 156)
Green	Lit	Projecting.
Orange	Lit	The projector is preparing to switch off the projector. The power is switched off after a while. (Changes to the standby mode.)

Note

- While the power indicator <ON (G)/STANDBY (R)> is lit in orange, the fan is running to cool the projector.
- For about 75 seconds after the projector is switched off and the luminous lamp cooling is started, the lamp indicators will not light up even if the power is switched on. After the power indicator <ON (G)/STANDBY (R)> lights in red, turn on the power again.
- The projector consumes power even in standby mode (power indicator <ON (G)/STANDBY (R)> lit in red). Refer to “Power consumption” (➔ page 182) for the power consumption.
- The power indicator <ON (G)/STANDBY (R)> flashes if a remote control signal is received.
- The power indicator <ON (G)/STANDBY (R)> flashes slowly in green while the shutter is closed.
- If the power indicator <ON (G)/STANDBY (R)> is flashing in red, consult your dealer.

Switching on the projector

Install the projection lens before switching on the projector.

Remove the lens cover first.

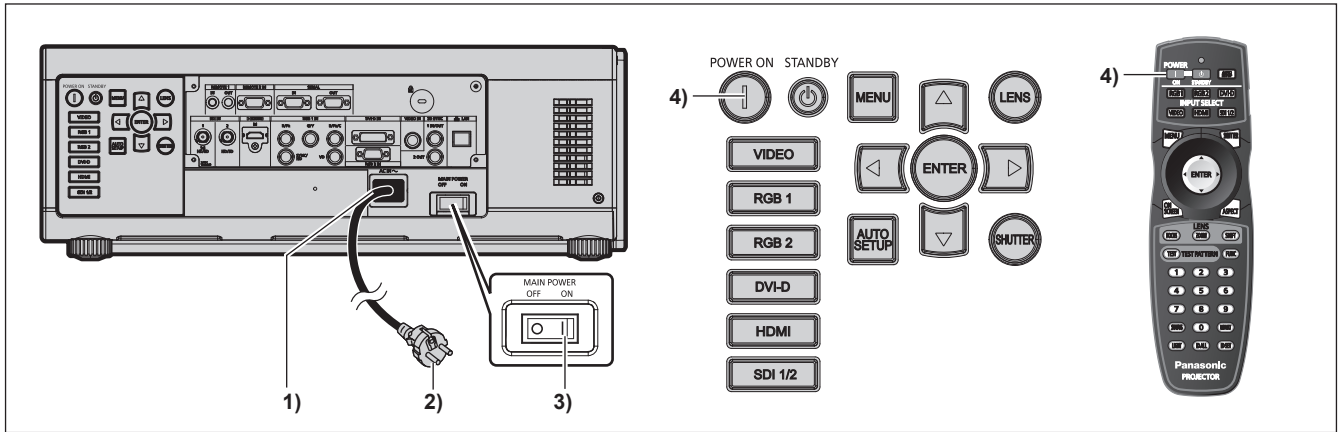

- 1) Connect the power cord to the projector body.**
- 2) Connect the power plug to an outlet.**
 - (AC 220 V - 240 V, 50 Hz/60 Hz)
- 3) Press the <ON> side of the <MAIN POWER> switch to turn on the power.**
 - The power indicator <ON (G)/STANDBY (R)> will light in red, and the projector will enter the standby mode.
- 4) Press the power on <|> button.**
 - The power indicator <ON (G)/STANDBY (R)> lights in green and the image is soon projected on the screen.

Attention

- Using the projector while the lens cover is attached may cause the device to heat up and result in a fire.

Note

- If the projector is switched on at around 0 °C (32 °F), a warm-up period of approximately five minutes may be necessary until an image is displayed. The temperature indicator <TEMP> lights during the warm-up period. When the warm-up is completed, the temperature indicator <TEMP> turns off and the projection starts. Refer to “When an indicator lights up” (➔ page 156) for the indicator status.
- If the operating environment temperature is low and warm-up takes more than five minutes, the projector will judge that a problem has occurred and the power will automatically be set to standby mode. If this happens, increase the operating environment temperature to 0 °C (32 °F) or higher, turn off the main power, and then switch on the projector again.
- If the [PROJECTOR SETUP] menu → [STANDBY MODE] is set to [ECO], it may take approx. 10 seconds longer before the projector starts projecting after the power is turned on, compared with when [NORMAL] is set.
- If the <MAIN POWER> switch was set to <OFF> during projection to end the projection using the direct power off function last time, and the <MAIN POWER> switch is set to <ON> with the power plug connected to the outlet, the power indicator <ON (G)/STANDBY (R)> will light in green and the image will soon be projected on the screen.

Making adjustments and selections

It is recommended that images are projected continuously for at least 30 minutes before the focus is adjusted.

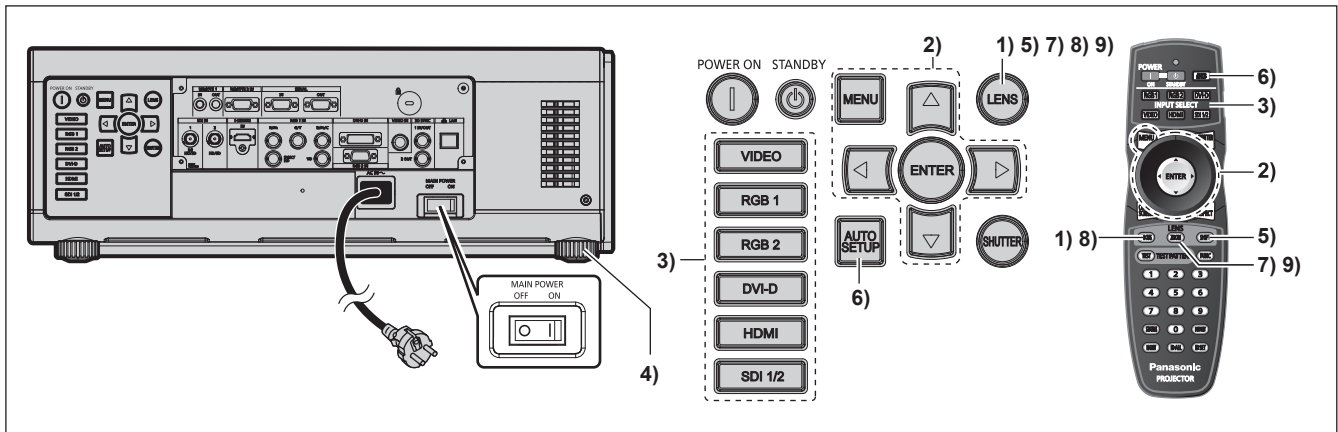

- 1) Press the <FOCUS> button to roughly adjust the focus of the image. (➔ page 56)
- 2) Change the settings of the [PROJECTOR SETUP] menu → [PROJECTION METHOD] and [COOLING CONDITION] depending on the installation mode. (➔ page 31)
 - Refer to “Navigating through the menu” (➔ page 65) for the operation of the menu screen.
- 3) Press the input selection (<RGB1>, <RGB2>, <DVI-D>, <VIDEO>, <HDMI>, <SDI 1/2>) buttons to select the input signal.
(SDI input is only for PT-DZ13KE, PT-DS12KE, PT-DZ10KE)
- 4) Adjust the front, back and sideways tilt of the projector with the adjustable feet. (➔ page 45)
- 5) Press the <SHIFT> button to adjust the position of the image.
- 6) If the input signal is an RGB signal, press the <AUTO SETUP> button.
- 7) Press the <ZOOM> button to adjust the size of the image to match the screen.
- 8) Press the <FOCUS> button again to adjust the focus.
- 9) Press the <ZOOM> button again to adjust the zoom and the size of the image to match the screen.

Note

- When the projector is switched on for the first time after purchase as well as when [ALL USER DATA] in the [PROJECTOR SETUP] menu → [INITIALIZE] is executed, the focus adjustment screen is displayed after projection starts, then the initial setting screen is displayed. Refer to “Start-up display” (➔ page 22) for details.

Switching off the projector

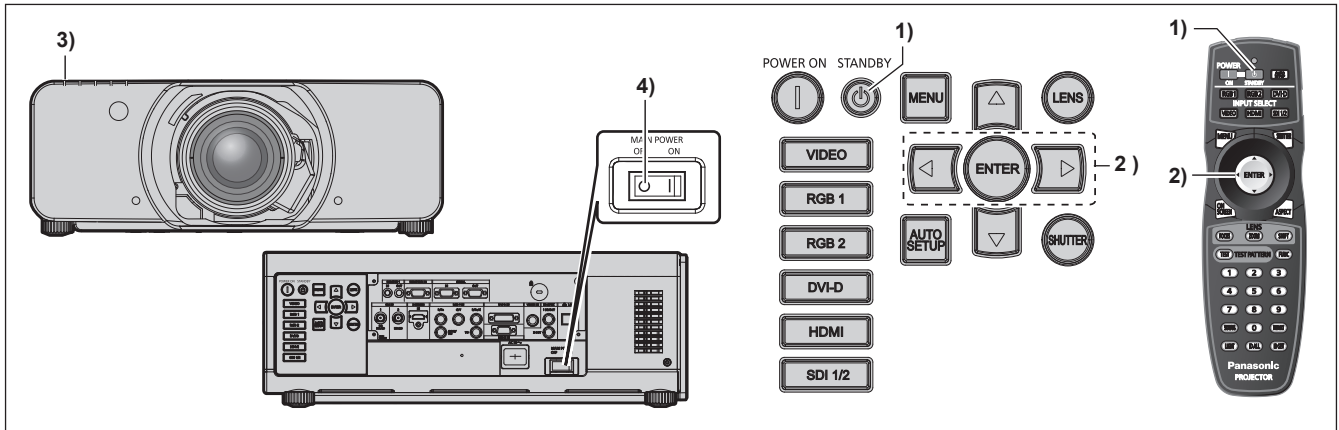

- 1) **Press the power standby <⏻> button.**
 - The [POWER OFF(STANDBY)] confirmation screen is displayed.
- 2) **Press ◀▶ to select [OK], and press the <ENTER> button.**
(Or press the power standby <⏻> button again.)
 - Projection of the image will stop, and the power indicator <ON (G)/STANDBY (R)> on the projector body lights in orange. (The fan keeps running.)
- 3) **Wait until the power indicator <ON (G)/STANDBY (R)> on the projector body lights in red (and the fan stops) for 170 seconds.**
- 4) **Press the <OFF> side of the <MAIN POWER> switch to turn off the power.**

Note

- Do not switch on the projector and project images immediately after switching off the projector. Turning on the power while the lamp is still hot may shorten the lamp life.
- For about 75 seconds after the projector is switched off and the luminous lamp cooling is started, the lamp indicators will not light up even if the power is switched on. Even after 75 seconds, the lamp may not light up if the projector is switched on. In such a case, after the power indicator <ON (G)/STANDBY (R)> lights in red, switch on the projector again.
- **The projector consumes power even when the power standby <⏻> button is pressed and the projector is switched off if the main power of the projector is on.**
 When the [PROJECTOR SETUP] menu → [STANDBY MODE] is set to [ECO], use of some functions is restricted, but the power consumption during standby can be conserved.

Direct power off function

Even if the main power <MAIN POWER> switch is turned <OFF> during projection or immediately after turning off the luminous lamp, the fan runs using internally stored power to cool the luminous lamp. When the projector is mounted on the ceiling or installed in an environment where the main power <MAIN POWER> switch of the projector cannot be easily turned <OFF>, the power can be turned off directly using the circuit breaker. It is also safe in case a power outage occurs or the power cord is pulled out immediately after the projector is switched off.

Note

- If the projector was turned off by turning off the circuit breaker directly during projection last time, then the power indicator <ON (G)/STANDBY (R)> will light in green a while after the circuit breaker is turned on, and then projection of the image will start.
- If cooled with the direct power off function, projection may take a longer time than usual to start when the projector is switched on the next time.
- Make sure that the fan is not running when packing the projector for transportation or storage.

Projecting

Check the projection lens attachment (➔ page 46), external device connection (➔ page 48), power cord connection (➔ page 52), switch on the power (➔ page 53) to start projecting. Select the video for projection, and adjust appearance of the projected image.

Selecting the input signal

Select an input signal.

1) Press the input selection (<RGB1>, <RGB2>, <DVI-D>, <VIDEO>, <HDMI>, <SDI 1/2>) buttons on the control panel or the remote control.

- The image of the signal being input in the selected terminal is projected.

Attention

- Images may not be projected properly depending on the external device, or the blu-ray disc or DVD disc, to be played back. Set the [PICTURE] menu → [SYSTEM SELECTOR].
- Confirm the aspect ratio of the projection screen and the image, and switch to an optimum aspect ratio from the [POSITION] menu → [ASPECT].

Adjusting the focus, zoom, and shift

If the projected image or the position is not correct when the positioning of the projector and the screen is correctly installed, adjust the focus, zoom, and shift.

Using the control panel

1) Press the <LENS> button on the control panel.

- Pressing the button changes the adjustment menu in the order of [FOCUS], [ZOOM], and [SHIFT].

2) Select each item and press ▲▼◀▶ to adjust it.

Using the remote control

1) Press the lens (<FOCUS>, <ZOOM>, <SHIFT>) buttons on the remote control.

- <FOCUS> button: Adjusts focus.
- <ZOOM> button: Adjusts zoom.
- <SHIFT> button: Adjusts shift.

2) Select each item and press ▲▼◀▶ to adjust it.

Caution

During the lens shift operation, do not insert your hand in any opening around the lens.
Your hand may be caught and result in injuries.

Note

- The zoom adjust menu will not be displayed when the projection lens without the zoom function is attached.
- Use the projection lens (Model No.: ET-D75LE5, ET-D75LE50) with the lens position set to the home position. (➔ page 57)
- The adjustment can be performed faster by pressing and holding ▲▼◀▶ while adjusting the focus and shift.
- It is recommended that images be projected continuously for at least 30 minutes before the focus is adjusted.
- Only [FOCUS] is shown in yellow so that the displayed menu item can be recognized by color, even when the projector is not focused and displayed characters are unreadable. (Factory default)
The display color of [FOCUS] depends on the setting of the [DISPLAY OPTION] menu → [ON-SCREEN DISPLAY] → [OSD DESIGN].
- When the power is switched off during focus and shift adjustment, lens calibration needs to be performed the next time the power is switched on. (➔ page 122)
- When the main power is switched off during focus adjustment, lens calibration is performed automatically during the next focus adjustment.
- When the main power is switched off during shift adjustment, a lens calibration error screen will be displayed during the next shift adjustment. Execute the [PROJECTOR SETUP] menu → [LENS CALIBRATION].
- When the lens calibration error is displayed even though [LENS CALIBRATION] was executed, ask your dealer to repair the unit.

Moving the lens to the home position

To move the lens to the home position, perform the following procedure.

1) While the [SHIFT] adjustment screen is displayed, press the <DEFAULT> button.

- The [HOME POSITION] screen is displayed.

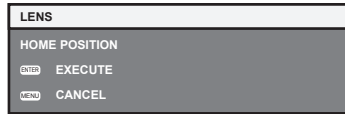

2) While the [HOME POSITION] screen is displayed (for approximately five seconds), press the <ENTER> button.

- [PROGRESS] is displayed in the [HOME POSITION] screen, and the lens returns to the home position.

Note

- The home position of the lens is the lens position when the lens is being replaced or when the projector is being stored, and it is not the optical center of the screen.
- You can also display the [HOME POSITION] screen by pressing the <LENS> button on the control panel or the <SHIFT> button on the remote control for at least three seconds.

Adjustment range by the lens position shift (optical shift)

Perform the lens position shift within the adjustment range.

The focus may change when the lens position is shifted out of the adjustment range. This is because the movement of the lens is restricted to protect the optical parts. Projection position can be adjusted with the optical axis shift based on the standard projection position in the respective range.

Projection lens Model No.	ET-D75LE1, ET-D75LE2, ET-D75LE3, ET-D75LE4, ET-D75LE8, ET-D75LE10, ET-D75LE20, ET-D75LE30, ET-D75LE40	ET-D75LE6
PT-DZ13KE, PT-DZ10KE	<p>Projection screen width H</p> <p>0.2 H</p> <p>0.12 V</p> <p>0.55 V</p> <p>Projection screen height V</p> <p>Standard projection position</p>	<p>Projection screen width H</p> <p>0.15 H</p> <p>0.12 V</p> <p>0.44 V</p> <p>Projection screen height V</p> <p>Standard projection position</p>
PT-DS12KE	<p>Projection screen width H</p> <p>0.3 H</p> <p>0.1 V</p> <p>0.5 V</p> <p>Projection screen height V</p> <p>Standard projection position</p>	<p>Projection screen width H</p> <p>0.2 H</p> <p>0.12 V</p> <p>0.4 V</p> <p>Projection screen height V</p> <p>Standard projection position</p>

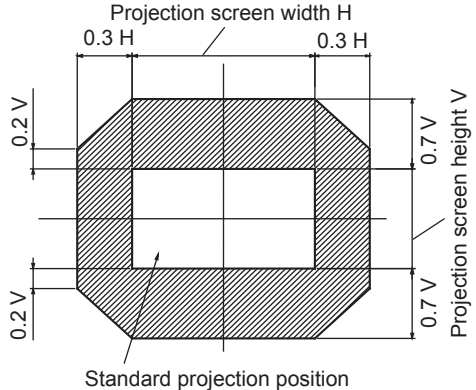
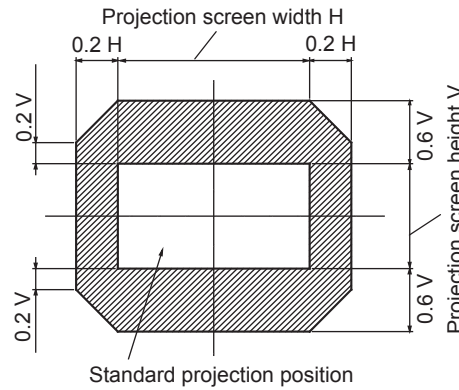
Projection lens Model No.	ET-D75LE1, ET-D75LE2, ET-D75LE3, ET-D75LE4, ET-D75LE8, ET-D75LE10, ET-D75LE20, ET-D75LE30, ET-D75LE40	ET-D75LE6
PT-DW11KE		

Note

- When the optional fixed-focus lens (Model No.: ET-D75LE5, ET-D75LE50) is attached, the shift cannot be adjusted.

Adjusting the lens mounter when the focus is unbalanced

Focus balance

Relationship between the tilt of the lens and the screen focus surface

When the projection lens is tilted in contrast with the image forming surface, tilting the front side (screen side) of the projection lens downwards (in the direction of the dotted arrow line), the upper side of the screen focus surface will tilt inwards and the lower side will tilt outwards as shown in the example.

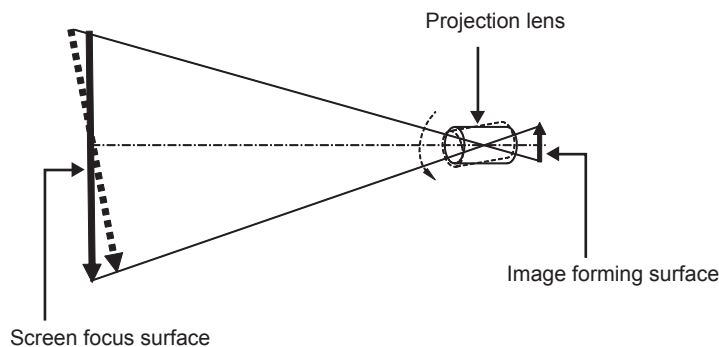

How to adjust the focus balance (adjustment by tilting the lens mounter)

When the entire screen surface is not uniform even if the focus has been adjusted, the lens mounter has focus adjustment screws in three locations.

- Tool used: Hex driver or Allen wrench (diagonal 2.5 mm (3/32"))
- The Allen wrench is included with the projection lens ET-D75LE6, ET-D75LE8.

Lens mounter structure

Focus adjustment screws (a), (b), and (c) can be turned to move the lens mount bracket back and forth.

Also, tightening the fixed screws locks the lens mount bracket in place so it does not move.

When a projection lens with a large weight is installed, or when the projector is installed on an inclination, the lens may tilt and the focus may become unbalanced. In these cases, perform adjustment by referring to the relationship between the adjustment location and adjustment screws.

■ Front view diagram of the lens mounter (viewed from the screen side)

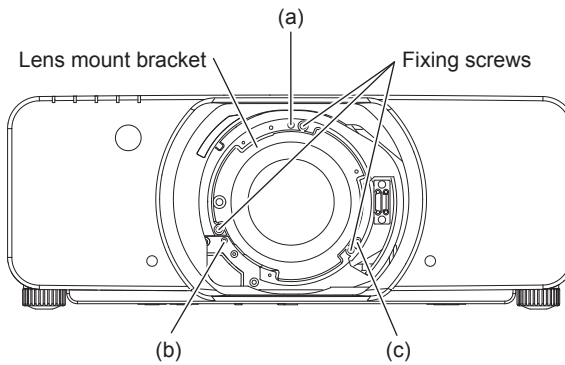

Note

- Focus adjustment screws (a), (b), and (c) are adjusted with the lens attached.

Adjustment procedure

■ Relationship between the adjustment location and adjustment screws

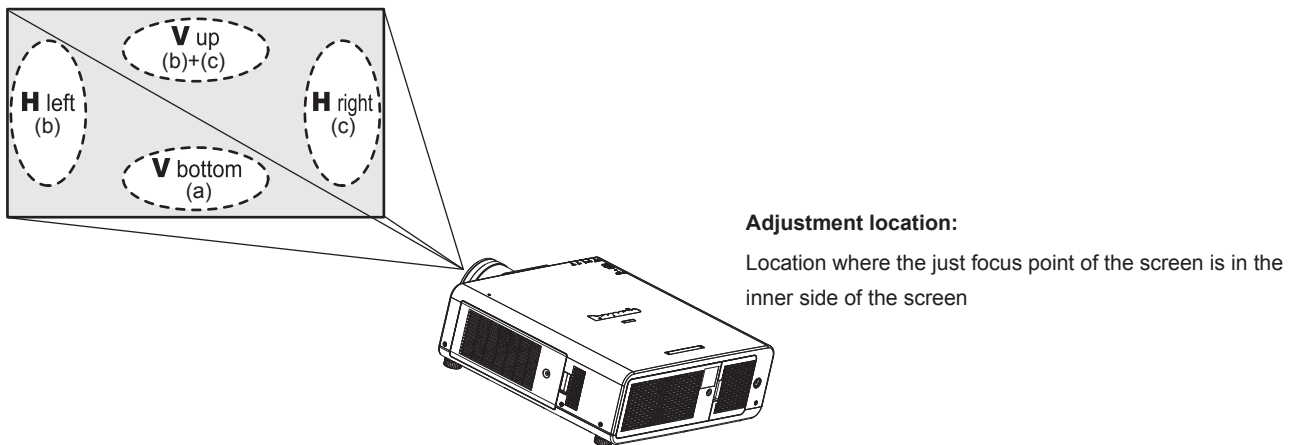

	When the just focus point of the screen in V up (top in the vertical direction) is in the inner side of the screen	When the just focus point of the screen in V bottom (bottom in the vertical direction) is in the inner side of the screen	When the just focus point of the screen in H left (left in the horizontal direction) is in the inner side of the screen	When the just focus point of the screen in H right (right in the horizontal direction) is in the inner side of the screen
(a)	Rotate counterclockwise	—	—	—
(b)	—	Rotate counterclockwise	Rotate counterclockwise	—
(c)	—	Rotate counterclockwise	—	Rotate counterclockwise

- 1) Press the <FOCUS> button on the remote control or the <LENS> button on the control panel to display the [FOCUS] adjustment menu.
- 2) Press ▼ to shift the focus of the entire screen once.
- 3) Press ▲ to stop on any part of the screen to be the first just focus point.
 - For the location where focus is shifted in this state, the just focus point is on the inner side of the screen.
- 4) Loosen the fixed screws in the position relative to the location where the focus is shifted the most (the location where the just focus point is shifted the most towards the inner side in Step 2)) up to two rotations.
 - Turn screws clockwise in two locations, or at least in one location to be adjusted.
- 5) Little by little, turn the focus adjustment screws corresponding to the locations counterclockwise and stop where the image is in focus. (⇒ page 58)
 - If the screws are turned counterclockwise, the tilt of the lens will change by moving the lens mount bracket of the lens mounter forward (screen side), and in the projected image on the screen, the focus point in the opposite direction of the adjustment screws will move from the inner side of the screen to the outside.

- 6) Press the <SHIFT> button on the remote control or the <LENS> button on the control panel to display the [SHIFT] adjustment menu, and reset the screen position of the projected image on the screen surface back to an optimal state.
- 7) Perform focus adjustment again near the center of the screen and if it is still not enough, fine tune the amount of rotation of the adjustment screws.
- 8) When adjustments have been made, securely tighten the loosened fixing screws.
- 9) Adjust the focus again using the remote control.

Operating with the remote control



Using the shutter function

If the projector is not used for a certain period of time during the meeting intermission, for example, it is possible to turn off the image temporarily.



button

- 1) **Press the <SHUTTER> button.**
 - The image disappears.
 - This operation can be also performed using the <SHUTTER> button on the control panel.
- 2) **Press the <SHUTTER> button again.**
 - The image is displayed.

Note

- The power indicator <ON (G)/STANDBY (R)> will flash slowly in green while the shutter is closed .
- You can set the speed of shutter opening/closing via the [DISPLAY OPTION] menu → [SHUTTER SETTING].

Using the on-screen display function

Turn off the on-screen display function (no display) when you do not wish the viewers to see the on-screen display, such as the menu or the input terminal name.



button

- 1) **Press the <ON SCREEN> button.**
 - The on-screen display disappears.
- 2) **Press the <ON SCREEN> button again.**
 - The on-screen display appears.

Note

- If you press the <MENU> button on the control panel for at least three seconds while the on-screen display is off (hidden), the on-screen display is turned on.

Switching the input signal

The input for projection can be switched.



1) Press the input selection (<RGB1>, <RGB2>, <DVI-D>, <VIDEO>, <HDMI>, <SDI 1/2>) buttons.

- This operation can be also performed using the buttons on the control panel.

<RGB1>	Switches the input to RGB1.
<RGB2>	Switches the input to RGB2.
<DVI-D>	Switches the input to DVI-D.
<VIDEO>	Switch the input to VIDEO.
<HDMI>	Switch the input to HDMI.
<SDI 1/2>*1	(PT-DZ13KE, PT-DS12KE) Switches the input to SDI1 or SDI2. Switches to another input when one input has already been chosen. You can also fix the input selection to either SDI1 or SDI2 from the [SECURITY] menu → [CONTROL DEVICE SETUP]. (PT-DZ10KE) Switches the input to SDI.

*1 Only for PT-DZ13KE, PT-DS12KE, PT-DZ10KE

Using the Status function

You can display the status of the projector.



1) Press the <STATUS> button.

- The [STATUS] screen is displayed.

The screenshot shows a screen titled "STATUS" with a page indicator "1/5" in the top right corner. The screen displays the following information:

INPUT	RGB2
SIGNAL NAME	XGA60-A8
SIGNAL FREQUENCY	48.36kHz/ 60.03Hz
PROJECTOR RUNTIME	140h
LAMP1	68h/ ON/
LAMP2	69h/ ON/
INTAKE AIR TEMP.	27°C/ 80°F
OPTICS MODULE TEMP.	33°C/ 92°F
AROUND LAMP TEMP.	33°C/ 92°F

At the bottom of the screen, there are three options: "SEND STATUS VIA E-MAIL", "CHANGE", and "EXIT".

Note

- This can be displayed from the [PROJECTOR SETUP] menu → [STATUS] (➔ page 119).

Using the Automatic setup function

The automatic setup function can be used to automatically adjust the resolution, clock phase, and image position when analog RGB signals consisting of bitmap images such as computer signals are being input, or to automatically adjust the image position when DVI-D/HDMI signals are input. Supplying images with bright white borders at the edges and high-contrast black and white characters is recommended when the system is in automatic adjustment mode.

Avoid supplying images that include halftones or gradation, such as photographs and computer graphics.



1) Press the <AUTO SETUP> button.

- [COMPLETE] is displayed when it has completed without any problem.

- This operation can be also performed using the <AUTO SETUP> button on the control panel.

Note

- The clock phase may shift even if it has completed without any incident. In such cases, adjust the [POSITION] menu → [CLOCK PHASE] (➔ page 81).
- If an image with blurred edges or a dark image is input, [INCOMPLETE] may appear or adjustment may not be performed properly even when [COMPLETE] appears. In this case, adjust the settings in the [ADVANCED MENU] menu → [INPUT RESOLUTION] (➔ page 86), [POSITION] → [CLOCK PHASE] (➔ page 81), and [SHIFT] (➔ page 79).
- Adjust special signals according to the [DISPLAY OPTION] menu → [AUTO SETUP] (➔ page 98).
- Automatic adjustment may not work depending on the model of the computer.
- Automatic adjustment may not work for a synchronization signal of C-SY or SYNC ON GREEN.
- Images may be disrupted for a few seconds during automatic adjustment, but it is not a malfunction.
- Adjustment is required for each input signal.
- Automatic adjustment can be canceled by pressing the <MENU> button during the automatic adjustment operation.
- If the automatic setup function is used while moving images are being input, the adjustment may not be performed properly even for an RGB signal that can use automatic setup. [INCOMPLETE] may appear, or adjustment may not be finished properly even if [COMPLETE] appears.

Using the Function button

[P IN P], [SUB MEMORY], [SYSTEM SELECTOR], [SYSTEM DAYLIGHT VIEW], [FREEZE], [WAVEFORM MONITOR], [LENS MEMORY LOAD], or [LEFT/RIGHT SWAP] operations can be assigned to the <FUNC> button on the remote control so that it can be used as an easy shortcut button.

button

- 1) Press the <FUNC> button.

Note

- [LEFT/RIGHT SWAP] can only be assigned in PT-DZ13KE, PT-DS12KE, PT-DW11KE.
- Assignment of the function is performed from the [PROJECTOR SETUP] menu → [FUNCTION BUTTON] (➔ page 121).

Displaying the internal test pattern

The projector has eight types of internal test patterns to check the condition of the set. To display test patterns, perform the following steps.

TEST PATTERN button

- 1) Press the <TEST> button.
- 2) Press ◀▶ to select the test pattern.

Note

- Setting is also available from the [TEST PATTERN] (➔ page 127) menu.
- Settings of position, size, and other factors will not be reflected in test patterns. Make sure to display the input signal before performing various adjustments.

Changing the picture aspect ratio

You can toggle through aspect ratios to select the one that is appropriate for the input signal.

button

- 1) Press the <ASPECT> button.
 - The setting will change each time you press the button.
 - Refer to [ASPECT] (➔ page 79) for details.

Chapter 4 Settings

This chapter describes the settings and adjustments you can make using the on-screen menu.

Menu navigation

The on-screen menu (Menu) is used to perform various settings and adjustments of the projector.

Navigating through the menu

Operating procedure



button

1) Press the <MENU> button on the remote control or control panel.

- The [MAIN MENU] screen is displayed.

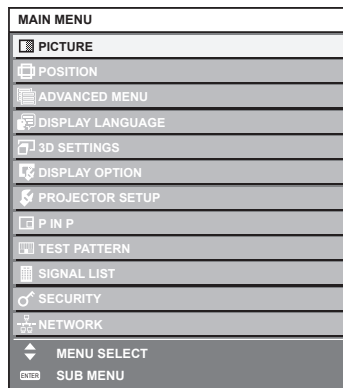

2) Press ▲▼ to select an item from the main menu.

- The selected item is highlighted in yellow.

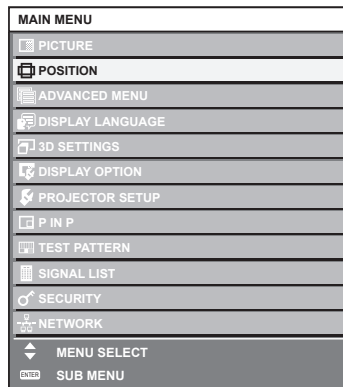

3) Press the <ENTER> button.

- The sub-menu items of the selected main menu are displayed.

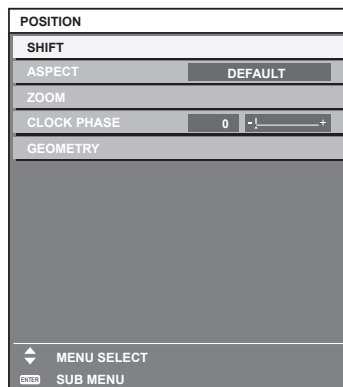

4) Press ▲▼ to select a sub-menu, and press ◀▶ or the <ENTER> button to change or adjust settings.

- Some items will switch in order as follows each time you press ◀▶.

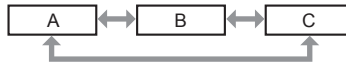

- For some items, press ◀▶ to display an individual adjustment screen with a bar scale as shown below.



Note

- Pressing the <MENU> button while the menu screen is displayed returns to the previous menu.
- Some items may not be adjusted or used for certain signal formats to be input to the projector. The menu items that cannot be adjusted or used are shown in gray characters, and they cannot be selected. [DIGITAL CINEMA REALITY] and [FRAME LOCK] may not be displayed depending on the input signal.
- Some items can be adjusted even if signals are not input.
- Individual adjustment screen is cleared automatically if no operation is performed for approximately five seconds.
- For menu items, refer to “Main menu” (➔ page 66) and “Sub-menu” (➔ page 67).
- The cursor color depends on the settings of the [DISPLAY OPTION] menu → [ON-SCREEN DISPLAY] → [OSD DESIGN]. The selected item is displayed with the yellow cursor by the factory default.
- In the portrait setting, the menu is displayed sideways.

Resetting adjustment values to the factory default

If the <DEFAULT> button on the remote control is pressed, the values adjusted in the menu items are restored to the factory default settings.



1) Press the <DEFAULT> button on the remote control.



Note

- You cannot reset all the settings to the factory default at a time.
- To reset all the settings adjusted in the sub-menu item to the factory default one at a time, execute [PROJECTOR SETUP] menu → [INITIALIZE] (➔ page 124).
- Some items cannot be reset by pressing the <DEFAULT> button. Adjust each item manually.
- The triangular mark under the bar scale in the individual adjustment screen indicates the factory default setting. The position of the triangular mark varies according to the selected input signals.

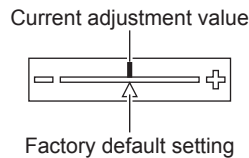







Main menu

The following items are in the main menu.

When a main menu item is selected, the screen changes to a sub-menu selection screen.

Main menu item		Page
	[PICTURE]	71
	[POSITION]	79
	[ADVANCED MENU]	85
	[DISPLAY LANGUAGE]	90
	[3D SETTINGS]*1	91
	[DISPLAY OPTION]	96

Main menu item		Page
	[PROJECTOR SETUP]	108
	[P IN P]	125
	[TEST PATTERN]	127
	[SIGNAL LIST]	128
	[SECURITY]	131
	[NETWORK]	135

*1 Only for PT-DZ13KE, PT-DS12KE, PT-DW11KE

Sub-menu

The sub-menu of the selected main menu item is displayed, and you can set and adjust items in the sub-menu.

[PICTURE]

Sub-menu item	Factory default	Page
[PICTURE MODE]	[STANDARD]*1	71
[CONTRAST]	[0]	71
[BRIGHTNESS]	[0]	72
[COLOR]	[0]	72
[TINT]	[0]	72
[COLOR TEMPERATURE]	[DEFAULT]	72
[GAMMA]	[DEFAULT]	74
[SYSTEM DAYLIGHT VIEW]	[OFF]	75
[SHARPNESS]	[+6]	75
[NOISE REDUCTION]	[OFF]	76
[DYNAMIC IRIS]	[2]	76
[SYSTEM SELECTOR]	[YP _B PR]*1	77

*1 Depends on the signal input.

Note

- The factory default settings may vary depending on the picture mode.

[POSITION]

Sub-menu item	Factory default	Page
[SHIFT]	—	79
[ASPECT]	[DEFAULT]*1	79
[ZOOM]	—	80
[CLOCK PHASE]	[0]*1	81
[GEOMETRY]*2	[OFF]	81
[KEystone]*3	—	84

*1 Depends on the signal input.

*2 Only for PT-DZ13KE, PT-DS12KE, PT-DZ10KE

*3 Only for PT-DW11KE

[ADVANCED MENU]

Sub-menu item	Factory default	Page
[DIGITAL CINEMA REALITY]	[AUTO]*1	85
[BLANKING]	—	85
[INPUT RESOLUTION]	—	86

Sub-menu item	Factory default	Page
[CLAMP POSITION]	[24]*1	86
[EDGE BLENDING]	[OFF]	87
[FRAME RESPONSE]	[NORMAL]	88
[FRAME LOCK]*2	[OFF]	89
[RASTER POSITION]	—	89

*1 Depends on the signal input.

*2 Only for PT-DZ13KE, PT-DS12KE, PT-DZ10KE

Note

- Sub-menu items and factory default settings differ depending on the selected input terminal.

[DISPLAY LANGUAGE]

Details (➔ page 90)

[3D SETTINGS]

(Only for PT-DZ13KE, PT-DS12KE, PT-DW11KE)

Sub-menu item	Factory default	Page
[3D SYSTEM SETTING]	[SINGLE]	91
[3D SYNC SETTING]	—	91
[3D SIMUL INPUT SETTING]	—	92
[3D INPUT FORMAT]	[AUTO]*1	92
[LEFT/RIGHT SWAP]	[NORMAL]	93
[3D COLOR MATCHING]	[SHARED 2D/3D]	93
[3D PICTURE BALANCE]	—	93
[DARK TIME SETTING]	[1.5 ms]	94
[3D FRAME DELAY]	[0us]	94
[3D TEST MODE]	[NORMAL]	94
[3D TEST PATTERN]	—	95
[SAFETY PRECAUTIONS MESSAGE]	[ON]	95
[3D SAFETY PRECAUTIONS]	—	95

*1 Depends on the selected input terminal.

[DISPLAY OPTION]

Sub-menu item	Factory default	Page
[COLOR MATCHING]	[OFF]	96
[LARGE SCREEN CORRECTION]	[OFF]	97
[SCREEN SETTING]*1	—	97
[AUTO SIGNAL]	[OFF]	98
[AUTO SETUP]	—	98
[RGB IN]	—	99
[DVI-D IN]	—	100
[HDMI IN]	—	100
[SDI IN]*1	—	100
[ON-SCREEN DISPLAY]	—	102
[BACK COLOR]	[BLUE]	103
[STARTUP LOGO]	[DEFAULT LOGO]	104
[UNIFORMITY]	—	104
[SHUTTER SETTING]	—	105
[FREEZE]	—	105
[WAVEFORM MONITOR]	[OFF]	105
[CUT OFF]	—	107

*1 Only for PT-DZ13KE, PT-DS12KE, PT-DZ10KE.

[PROJECTOR SETUP] 

Sub-menu item	Factory default	Page
[PROJECTOR ID]	[ALL]	108
[PROJECTION METHOD]	[FRONT/FLOOR]	108
[COOLING CONDITION]	[AUTO]	109
[HIGH ALTITUDE MODE]	[OFF]	109
[LAMP SELECT]	[DUAL]	109
[LAMP RELAY]	[OFF]	110
[LAMP POWER]	[HIGH]* ¹	111
[BRIGHTNESS CONTROL]	—	111
[STANDBY MODE]	[NORMAL]	115
[SCHEDULE]	[OFF]	116
[STARTUP INPUT SELECT]	[LAST USED]	117
[RS-232C]	—	118
[STATUS]	—	119
[NO SIGNAL SHUT-OFF]	[DISABLE]	120
[REMOTE2 MODE]	[DEFAULT]	120
[FUNCTION BUTTON]	—	121
[DATE AND TIME]	—	121
[LENS CALIBRATION]	—	122
[LENS MEMORY]	—	122
[SAVE ALL USER DATA]	—	124
[LOAD ALL USER DATA]	—	124
[INITIALIZE]	—	124
[SERVICE PASSWORD]	—	124

*1 It is [NORMAL] for PT-DZ10KE. In the portrait setting, it is [MIDDLE] for PT-DZ13KE, PT-DS12KE, PT-DW11KE.

[P IN P] 

Details (➔ page 125)

[TEST PATTERN] 

Details (➔ page 127)

[SIGNAL LIST] 

Details (➔ page 128)

[SECURITY] 

Sub-menu item	Factory default	Page
[SECURITY PASSWORD]	[OFF]	131
[SECURITY PASSWORD CHANGE]	—	131
[DISPLAY SETTING]	[OFF]	132
[TEXT CHANGE]	—	132
[CONTROL DEVICE SETUP]	—	132
[CONTROL DEVICE PASSWORD CHANGE]	—	133

[NETWORK] 

Sub-menu item	Factory default	Page
[NETWORK SETUP]	—	135
[NETWORK CONTROL]	—	135
[NETWORK STATUS]	—	136
[Art-Net SETUP]	[OFF]	136

Note

- Some items may not be adjusted or used for certain signal formats to be input to the projector.
The menu items that cannot be adjusted or used are shown in gray characters, and they cannot be selected.
- Sub-menu items and factory default settings differ depending on the selected input terminal.

[PICTURE] menu

On the menu screen, select [PICTURE] from the main menu, and select an item from the sub-menu.

Refer to “Navigating through the menu” (→ page 65) for the operation of the menu screen.

- After selecting the item, press ▲▼◀▶ to set.

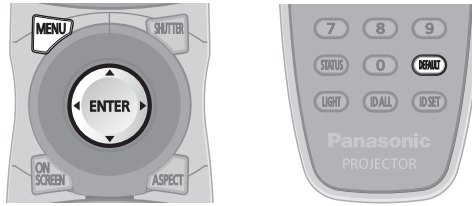

[PICTURE MODE]

You can switch to the desired picture mode suitable for the image source and the environment in which the projector is used.

- 1) Press ▲▼ to select [PICTURE MODE].
- 2) Press the ◀▶.
 - The [PICTURE MODE] individual adjustment screen is displayed.
- 3) Press ◀▶ to switch the item.
 - The items will switch each time you press the button.

[STANDARD]	The image becomes suitable for moving images in general.
[CINEMA]	The image becomes suitable for movie contents.
[NATURAL]	The image is sRGB compliant.
[DICOM SIM.]	The image becomes similar to that of DICOM Part 14 Grayscale Standard.
[DYNAMIC]	The light output is maximized for use in bright areas.
[GRAPHIC]	The image becomes suitable for input from the personal computer.
[USER]	Set any desired picture mode.

Note

- The factory default picture mode is [GRAPHIC] for still image input signals and [STANDARD] for movie-based input signals.
- DICOM is an abbreviation of “Digital Imaging and COmmunication in Medicine” and is a standard for medical imaging devices. Although the DICOM name is used, the projector is not a medical device, and should not be used for purposes such as diagnosis of display images.
- Press the <ENTER> button when each [PICTURE MODE] is selected to save as a specified value when a new signal is input. The data of all items except [SYSTEM SELECTOR] in the [PICTURE] menu is saved.
- In the factory default settings, [USER] is set to images that comply with the ITU-R BT.709 standard.

Changing the [USER] name

- 1) Press ▲▼ to select [PICTURE MODE].
- 2) Press ◀▶ to select [USER].
- 3) Press the <ENTER> button.
 - The [PICTURE MODE] detailed screen is displayed.
- 4) Press ▲▼ to select [PICTURE MODE NAME CHANGE], and press the <ENTER> button.
 - The [PICTURE MODE NAME CHANGE] screen is displayed.
- 5) Press ▲▼◀▶ to select the text, and press the <ENTER> button to enter the text.
- 6) Press ▲▼◀▶ to select [OK], and press the <ENTER> button.
 - The picture mode name is changed.

[CONTRAST]

You can adjust the contrast of the colors.

- 1) Press ▲▼ to select [CONTRAST].

- 2) Press ◀▶ or the <ENTER> button.
 - The [CONTRAST] individual adjustment screen is displayed.
- 3) Press ◀▶ to adjust the level.

Operation	Adjustment	Range of adjustment
Press the ▶ button.	Brightens the screen and makes the color deeper.	-31 - +31
Press the ◀ button.	Darkens the screen and makes the color lighter.	

Attention

- Adjust [BRIGHTNESS] first when you need to adjust the black level.

[BRIGHTNESS]

You can adjust the dark (black) part of the projected image.

- 1) Press ▲▼ to select [BRIGHTNESS].
- 2) Press ◀▶ or the <ENTER> button.
 - The [BRIGHTNESS] individual adjustment screen is displayed.
- 3) Press ◀▶ to adjust the level.

Operation	Adjustment	Range of adjustment
Press the ▶ button.	Increases the brightness of the dark (black) parts of the screen.	-31 - +31
Press the ◀ button.	Reduces the brightness of the dark (black) parts of the screen.	

[COLOR]

You can adjust the color saturation of the projected image.

- 1) Press ▲▼ to select [COLOR].
- 2) Press ◀▶ or the <ENTER> button.
 - The [COLOR] individual adjustment screen is displayed.
- 3) Press ◀▶ to adjust the level.

Operation	Adjustment	Range of adjustment
Press the ▶ button.	Deepens colors.	-31 - +31
Press the ◀ button.	Weakens colors.	

[TINT]

You can adjust the skin tone in the projected image.

- 1) Press ▲▼ to select [TINT].
- 2) Press ◀▶ or the <ENTER> button.
 - The [TINT] individual adjustment screen is displayed.
- 3) Press ◀▶ to adjust the level.

Operation	Adjustment	Range of adjustment
Press the ▶ button.	Adjusts skin tone toward greenish color.	-31 - +31
Press the ◀ button.	Adjusts skin tone toward reddish purple.	

[COLOR TEMPERATURE]

You can switch the color temperature if the white areas of the projected image are bluish or reddish.

Adjusting with color temperature

- 1) Press ▲▼ to select [COLOR TEMPERATURE].

- 2) Press ◀▶ or the <ENTER> button.
 - The [COLOR TEMPERATURE] individual adjustment screen is displayed.
- 3) Press ◀▶ to switch the item.
 - The items will switch each time you press the button.

[DEFAULT]	Factory default setting.
[USER1]	Adjusts white balance as desired. Refer to "Adjusting desired white balance" (▶ page 73) for details.
[USER2]	
[3200K] - [9300K]	Allows you to set in increments of 100 K. Select so that images become natural.

Note

- When [PICTURE MODE] (▶ page 71) is set to [USER] or [DICOM SIM.], [DEFAULT] cannot be selected.
- When [COLOR MATCHING] (▶ page 96) adjustment is set to other than [OFF], [COLOR TEMPERATURE] is fixed to [USER1].
- The color temperature numerical values are guidelines.

Adjusting desired white balance

- 1) Press ▲▼ to select [COLOR TEMPERATURE].
- 2) Press ◀▶ or the <ENTER> button.
 - The [COLOR TEMPERATURE] individual adjustment screen is displayed.
- 3) Press ◀▶ to select [USER1] or [USER2].
- 4) Press the <ENTER> button.
 - The [COLOR TEMPERATURE] screen is displayed.
- 5) Press ▲▼ to select [WHITE BALANCE].
- 6) Press the <ENTER> button.
 - The [WHITE BALANCE] screen is displayed.
- 7) Press ▲▼ to select [WHITE BALANCE HIGH] or [WHITE BALANCE LOW].
- 8) Press the <ENTER> button.
 - The [WHITE BALANCE HIGH] screen or the [WHITE BALANCE LOW] screen is displayed.
- 9) Press ▲▼ to select [RED], [GREEN], or [BLUE].
- 10) Press ◀▶ to adjust the level.

Item	Operation	Adjustment	Range of adjustment
[RED]	Press the ▶ button.	Deepens red.	[WHITE BALANCE HIGH]: 0 - +255 (factory default is +255) [WHITE BALANCE LOW]: -127 - +127 (factory default is 0)
	Press the ◀ button.	Weakens red.	
[GREEN]	Press the ▶ button.	Deepens green.	
	Press the ◀ button.	Weakens green.	
[BLUE]	Press the ▶ button.	Deepens blue.	
	Press the ◀ button.	Weakens blue.	

Note

- Adjust [COLOR TEMPERATURE] correctly. All colors will not be displayed properly unless adequate adjustment is made. If the adjustment does not look suitable, you can press the <DEFAULT> button on the remote control to return the setting for the selected item only to the factory default setting.

Adjusting desired white balance based on existing color temperature settings

- 1) Press ▲▼ to select [COLOR TEMPERATURE].
- 2) Press ◀▶ or the <ENTER> button.
 - The [COLOR TEMPERATURE] individual adjustment screen is displayed.
- 3) Press ◀▶ to select an item other than [DEFAULT], [USER1], or [USER2].

- 4) **Press the <ENTER> button.**
 - The [CHANGE TO *****] screen is displayed.
- 5) **Press ▲▼ to select [USER1] or [USER2].**
 - The status of the color temperature changed is saved to the selected item.
- 6) **Press the <ENTER> button.**
 - The confirmation screen is displayed.
- 7) **Press ◀▶ to select [OK], and press the <ENTER> button.**
 - The [USER1] or [USER2] data is overwritten.
 - If you press ◀▶ to select [CANCEL] and then press the <ENTER> button, the data will not be overwritten.
 - The [WHITE BALANCE HIGH] screen is displayed.
- 8) **Press ▲▼ to select [RED], [GREEN], or [BLUE].**
- 9) **Press ◀▶ to adjust the level.**

Note

- Adjust [COLOR TEMPERATURE] correctly. All colors will not be displayed properly unless adequate adjustment is made. If the adjustment does not look suitable, you can press the <DEFAULT> button on the remote control to return the setting for the selected item only to the factory default setting.
- When color temperature has been changed, the colors before and after the change will differ slightly.

Changing the name of [USER1] or [USER2]

- 1) **Press ▲▼ to select [COLOR TEMPERATURE].**
- 2) **Press ◀▶ or the <ENTER> button.**
 - The [COLOR TEMPERATURE] individual adjustment screen is displayed.
- 3) **Press ◀▶ to select [USER1] or [USER2].**
- 4) **Press the <ENTER> button.**
 - The [COLOR TEMPERATURE] screen is displayed.
- 5) **Press ▲▼ to select [COLOR TEMPERATURE NAME CHANGE].**
- 6) **Press the <ENTER> button.**
 - The [COLOR TEMPERATURE NAME CHANGE] screen is displayed.
- 7) **Press ▲▼◀▶ to select the text, and press the <ENTER> button to enter the text.**
- 8) **Press ▲▼◀▶ to select [OK], and press the <ENTER> button.**
 - The name set to color temperature is changed.

Note

- When a name is changed, display of [USER1], [USER2] is also changed.

[GAMMA]

You can switch gamma mode.

- 1) **Press ▲▼ to select [GAMMA].**
- 2) **Press ◀▶ or the <ENTER> button.**
 - The [GAMMA] individual adjustment screen is displayed.
- 3) **Press ◀▶ to switch the item.**
 - The items will switch each time you press the button.

[DEFAULT] ^{*1}	Factory default setting.
[USER1]	Allows you to change the name.
[USER2]	Refer to “Changing the name of [USER1] or [USER2]” (➔ page 75) for details.
[DICOM SIM.]	The picture becomes similar to that of DICOM standard.

[1.0]	Set so that images become as you like. [2.0] - [2.8] can be set in increments of 0.1.
[1.8]	
[2.0] - [2.8] (increments of 0.1)	

*1 When [PICTURE MODE] is set to [DYNAMIC], [USER], or [DICOM SIM.], [DEFAULT] cannot be selected.

Note

- DICOM is an abbreviation of “Digital Imaging and COmmunication in Medicine” and is a standard for medical imaging devices. Although the DICOM name is used, the projector is not a medical device, and should not be used for purposes such as diagnosis of display images.

Changing the name of [USER1] or [USER2]

- 1) Press ▲▼ to select [GAMMA].
- 2) Press ◀▶ or the <ENTER> button.
 - The [GAMMA] individual adjustment screen is displayed.
- 3) Press ◀▶ to select [USER1] or [USER2].
- 4) Press the <ENTER> button.
 - The [GAMMA] screen is displayed.
- 5) Press the <ENTER> button.
 - The [GAMMA NAME CHANGE] screen is displayed.
- 6) Press ▲▼◀▶ to select the text, and press the <ENTER> button to enter the text.
- 7) Press ▲▼◀▶ to select [OK], and press the <ENTER> button.
 - The selected gamma name is changed.

Note

- When a name is changed, display of [USER1], [USER2] is also changed.

[SYSTEM DAYLIGHT VIEW]

You can correct the image to the optimal vividness even if it is projected under a bright light.

- 1) Press ▲▼ to select [SYSTEM DAYLIGHT VIEW].
- 2) Press ◀▶ or the <ENTER> button.
 - The [SYSTEM DAYLIGHT VIEW] individual adjustment screen is displayed.
- 3) Press ◀▶ to switch the item.
 - The items will switch each time you press the button.

[OFF]	No correction.
[1]	Corrects the image to weaken vividness.
[2]	Corrects the image to medium vividness.
[3]	Corrects the image to high vividness.

[SHARPNESS]

You can adjust the sharpness of the projected image.

- 1) Press ▲▼ to select [SHARPNESS].
- 2) Press ◀▶ or the <ENTER> button.
 - The [SHARPNESS] individual adjustment screen is displayed.
- 3) Press ◀▶ to adjust the level.

Operation	Adjustment	Range of adjustment
Press the ▶ button.	Contours become sharper.	0 - +15
Press the ◀ button.	Contours become softer.	

Note

- If you press ► while the adjustment value is [+15], the value will become [0]. If you press ◀ while the adjustment value is [0], the value will become [+15].

[NOISE REDUCTION]

You can reduce noises when the input image is degraded and noise is occurring in the image signal.

- 1) Press ▲▼ to select [NOISE REDUCTION].
- 2) Press ◀▶ or the <ENTER> button.
 - The [NOISE REDUCTION] individual adjustment screen is displayed.
- 3) Press ◀▶ to switch the item.
 - The items will switch each time you press the button.

[OFF]	No correction.
[1]	Slightly corrects the noise.
[2]	Moderately corrects the noise.
[3]	Strongly corrects the noise.

Attention

- When this is set for an input signal with less noise, the image may look different from what it originally was. In such a case, set it to [OFF].

[DYNAMIC IRIS]

Aperture correction and signal compensation are performed automatically based on the image to result in an image of optimum contrast.

- 1) Press ▲▼ to select [DYNAMIC IRIS].
- 2) Press ◀▶ or the <ENTER> button.
 - The [DYNAMIC IRIS] individual adjustment screen is displayed.
- 3) Press ◀▶ to switch the item.
 - The items will switch each time you press the button.

[OFF]	No correction.
[1]	Slightly corrects aperture and compensate signals.
[2]	Moderately corrects aperture and signal.
[3]	Strongly corrects aperture and signal.
[USER]	Set any desired correction. Refer to "Adjusting desired correction amount" (➔ page 76) for details.

Adjusting desired correction amount

- 1) Press ▲▼ to select [DYNAMIC IRIS].
- 2) Press ◀▶ or the <ENTER> button.
 - The [DYNAMIC IRIS] individual adjustment screen is displayed.
- 3) Press ◀▶ to select [USER].
- 4) Press the <ENTER> button.
 - The [DYNAMIC IRIS] screen is displayed.
- 5) Press ▲▼ to select [AUTO IRIS], [MANUAL IRIS], or [DYNAMIC GAMMA].
- 6) Press ◀▶ to adjust the correction amount.

Item	Adjustment	
[AUTO IRIS] (Automatic adjustment of aperture)	[OFF]	No correction.
	[1] - [255]	Allows you to set in increments of 1. The larger the value, the stronger the correction.
[MANUAL IRIS] (Fixed adjustment of aperture)	[OFF]	No correction.
	[1] - [255]	Allows you to set in increments of 1. The larger the value, the stronger the correction.

Item	Adjustment	
[DYNAMIC GAMMA] (Adjustment of signal compensation)	[OFF]	No correction.
	[1]	Slightly compensates the signal.
	[2]	Moderately compensates the signal.
	[3]	Strongly compensates the signal.

Note

- When [DYNAMIC GAMMA] is set to [3], the contrast will be maximized.
- Brightness control and iris operate simultaneously, but the iris is fully open and does not operate while a brightness measurement is performed.

[SYSTEM SELECTOR]

The projector will automatically detect the input signal, but you can set the system method manually when an unstable signal is input. Set the system method matching the input signal.

- 1) Press **▲▼** to select [SYSTEM SELECTOR].
- 2) Press the **<ENTER>** button.
- 3) Press **▲▼** to select a system format.

- Available system formats vary depending on the input signal.

Terminal	System format	
<VIDEO IN> terminal, <G/Y>/<B/P _B /C> terminals	Select [AUTO], [NTSC], [NTSC4.43], [PAL], [PAL-M], [PAL-N], [SECAM], or [PAL60]. Set it to [AUTO] normally. (Setting [AUTO] will automatically select [NTSC], [NTSC4.43], [PAL], [PAL-M], [PAL-N], [SECAM], or [PAL60].) Switch the setting to the signal method for the TV used.	
<RGB 1 IN> terminal, <RGB 2 IN> terminal	480i, 576i, or 576p signal	Select [RGB] or [Y _{C_BC_R}].
	VGA60 or 480p signal	Select [VGA60], [480p Y _{C_BC_R}], or [480p RGB].
	Other movie-based signals	Select [RGB] or [Y _{P_BP_R}].
<DVI-D IN> terminal	480i, 576i, 480p, or 576p signal	Select [RGB] or [Y _{C_BC_R}].
	Other movie-based signals	Select [RGB] or [Y _{P_BP_R}].
<HDMI IN> terminal	480i, 576i, 480p, or 576p signal	Select [AUTO], [RGB], or [Y _{C_BC_R}].
	Other movie-based signals	Select [AUTO], [RGB], or [Y _{P_BP_R}].
<SDI IN 1> terminal, <SDI IN 2> terminal (only for PT-DZ13KE, PT-DS12KE)	Single link	During SDI1 (SDI) input, select [AUTO], [480i Y _{C_BC_R}], [576i Y _{C_BC_R}], [720/50p Y _{P_BP_R}], [720/60p Y _{P_BP_R}], [1035/60i Y _{P_BP_R}], [1080/24p Y _{P_BP_R}], [1080/24sF Y _{P_BP_R}], [1080/25p Y _{P_BP_R}], [1080/30p Y _{P_BP_R}], [1080/50i Y _{P_BP_R}], [1080/60i Y _{P_BP_R}], [1080/50p Y _{P_BP_R}], [1080/60p Y _{P_BP_R}], [1080/24p RGB], [1080/24sF RGB], [1080/25p RGB], [1080/30p RGB], [1080/50i RGB], or [1080/60i RGB]. During SDI2 input, select [AUTO], [480i Y _{C_BC_R}], [576i Y _{C_BC_R}], [720/50p Y _{P_BP_R}], [720/60p Y _{P_BP_R}], [1035/60i Y _{P_BP_R}], [1080/24p Y _{P_BP_R}], [1080/24sF Y _{P_BP_R}], [1080/25p Y _{P_BP_R}], [1080/30p Y _{P_BP_R}], [1080/50i Y _{P_BP_R}], or [1080/60i Y _{P_BP_R}].
	Dual link	Select [AUTO], [1080/24p RGB], [2K/24p RGB], [2K/24p XYZ], [1080/24sF RGB], [2K/24sF RGB], [2K/24sF XYZ], [1080/25p RGB], [1080/30p RGB], [1080/50i RGB], or [1080/60i RGB].
<SDI IN> terminal (only for PT-DZ10KE)	Select [AUTO], [480i Y _{C_BC_R}], [576i Y _{C_BC_R}], [720/50p Y _{P_BP_R}], [720/60p Y _{P_BP_R}], [1035/60i Y _{P_BP_R}], [1080/24p Y _{P_BP_R}], [1080/24sF Y _{P_BP_R}], [1080/25p Y _{P_BP_R}], [1080/30p Y _{P_BP_R}], [1080/50i Y _{P_BP_R}], [1080/60i Y _{P_BP_R}], [1080/50p Y _{P_BP_R}], [1080/60p Y _{P_BP_R}], [1080/24p RGB], [1080/24sF RGB], [1080/25p RGB], [1080/30p RGB], [1080/50i RGB], or [1080/60i RGB].	

- 4) Press the **<ENTER>** button.

Note

- Refer to “List of compatible signals” (➔ page 177) for the types of video signals that can be used with the projector.
- This may not function properly for some connected external devices.

sRGB-compliant video

sRGB is an international standard (IEC61966-2-1) for color reproduction defined by IEC (International Electrotechnical Commission). Set according to the following steps to reproduce more faithful, sRGB compliant colors.

- 1) **Set [COLOR MATCHING] adjustments to [OFF].**
 - Refer to [COLOR MATCHING] (➔ page 96).
- 2) **Display the [PICTURE] menu.**
 - Refer to “[PICTURE] menu” (➔ page 71).
- 3) **Press ▲▼ to select [PICTURE MODE].**
- 4) **Press ◀▶ to set [NATURAL].**
- 5) **Press ▲▼ to select [COLOR].**
- 6) **Press the <DEFAULT> button on the remote control to set the factory default setting.**
- 7) **Follow Steps 5) to 6) to set [TINT], [COLOR TEMPERATURE], [GAMMA], and [SYSTEM DAYLIGHT VIEW] to the factory default settings.**

Note

- sRGB is available for RGB signal input only.

[POSITION] menu

On the menu screen, select [POSITION] from the main menu, and select an item from the sub-menu.

Refer to “Navigating through the menu” (➔ page 65) for the operation of the menu screen.

- After selecting the item, press ▲▼◀▶ to set.

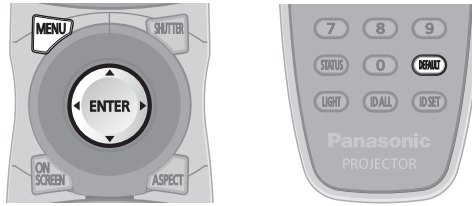

[SHIFT]

Move the image position vertically or horizontally if the image position projected on the screen is shifted even when the relative position of the projector and the screen is installed correctly.

- 1) Press ▲▼ to select [SHIFT].
- 2) Press the <ENTER> button.
 - The [SHIFT] screen is displayed.
- 3) Press ▲▼◀▶ to adjust the position.

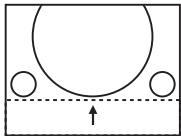
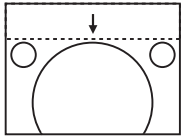
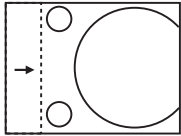
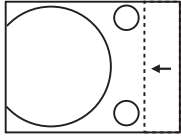
Orientation	Operation	Adjustment
Vertical (up and down) adjustment	Press the ▲ button.	The image position moves up. 
	Press the ▼ button.	The image position moves down. 
Horizontal (right and left) adjustment	Press the ▶ button.	The image position moves to the right. 
	Press the ◀ button.	The image position moves to the left. 

Note

- For the portrait setting, image position is moved horizontally when “Vertical (up and down) adjustment” is made. Image position is moved vertically when “Horizontal (right and left) adjustment” is made.

[ASPECT]

You can switch the aspect ratio of the image.

The aspect ratio is switched within the screen range selected in [SCREEN SETTING]. Set [SCREEN SETTING] first. (➔ page 97)

- 1) Press ▲▼ to select [ASPECT].
- 2) Press ◀▶ or the <ENTER> button.
 - The [ASPECT] individual adjustment screen is displayed.
- 3) Press ◀▶ to switch the item.
 - The items will switch each time you press the button.

[DEFAULT]	Displays images without changing the aspect ratio of the input signals.
[VID AUTO]*1	The projector identifies the video ID (VID) embedded in the video signals and displays the image by automatically switching the screen sizes between 4:3 and 16:9. This function is effective for NTSC signals.
[AUTO]*2	The projector identifies the video ID (VID) embedded in the video signals and displays the image by automatically switching the screen sizes between 4:3 and 16:9. This function is effective for 480i/480p signals.
[THROUGH]	Displays images without changing the resolution of the input signals.
[16:9]	Displays images with the aspect ratio converted to 16:9 when standard signals are input*3. Display images without changing the aspect ratio when wide-screen signals are input*4.
[4:3]	Displays images without changing the aspect ratio when standard signals are input*3. Displays images without changing the aspect ratio so that the images will fit in the 4:3 screen when wide-screen signals are input*2.
[H FIT]	Displays images using the entire width of the screen. When signals have the aspect ratio vertically longer than the aspect ratio of the screen selected in [SCREEN FORMAT], the images are displayed with the top and bottom parts cut off.
[V FIT]	Displays images using the entire height of the screen range selected in [SCREEN FORMAT]. When signals have the aspect ratio horizontally longer than the aspect ratio of the screen selected in [SCREEN FORMAT], the images are displayed with the right and left parts cut off.
[HV FIT]	Displays images in the entire screen range selected in [SCREEN FORMAT]. When the aspect ratio of the input signals differs from that of the screen range, the images are displayed with the aspect ratio converted to that of the screen selected in [SCREEN FORMAT].

*1 For video signals and Y/C signals (NTSC) only

*2 For RGB (480i or 480p) signal input only

*3 Standard signals are input signals with an aspect ratio of 4:3 or 5:4.

*4 Wide-screen signals are input signals with an aspect ratio of 16:10, 16:9, 15:9 or 15:10.

Note

- Some size modes are not available for certain types of input signals. [DEFAULT] cannot be selected for video signal, Y/C signal (NTSC), or RGB (480i, 480p) signal.
- If an aspect ratio which is different from the aspect ratio for the input signals is selected, the images will appear differently from the originals. Be careful of this when selecting the aspect ratio.
- If using the projector in places such as cafes or hotels to display programs for a commercial purpose or for public presentation, note that adjusting the aspect ratio or using the zoom function to change the screen images may be an infringement of the rights of the original copyright owner for that program under copyright protection laws. Take care when using a function of the projector such as the aspect ratio adjustment and zoom function.
- If conventional (normal) 4:3 images which are not wide-screen images are displayed on a wide screen, the edges of the images may not be visible or they may become distorted. Such images should be viewed as with an aspect ratio of 4:3 in the original format intended by the creator of the images.

[ZOOM]

You can adjust the image size.

When [ASPECT] is set to other than [DEFAULT] and [THROUGH]

- 1) Press ▲▼ to select [ZOOM].
- 2) Press the <ENTER> button.
 - The [ZOOM] screen is displayed.
- 3) Press ▲▼ to select [INTERLOCKED].
- 4) Press ◀▶ to switch the item.

[OFF]	Sets the [VERTICAL] and [HORIZONTAL] zoom ratio.
[ON]	Uses [BOTH] to set zoom ratio. Image can be enlarged or reduced vertically and horizontally at the same magnification.

- 5) Press ▲▼ to select [VERTICAL] or [HORIZONTAL].
 - If [ON] is selected, select [BOTH].
- 6) Press ◀▶ to adjust.

Note

- When [ASPECT] is set to [THROUGH], [ZOOM] cannot be adjusted.

When [ASPECT] is set to [DEFAULT]

- 1) Press ▲▼ to select [ZOOM].
- 2) Press the <ENTER> button.
 - The [ZOOM] screen is displayed.
- 3) Press ▲▼ to select [MODE].
- 4) Press ◀▶ to switch the item.

[INTERNAL]	Enlarges the size within the aspect range set with [SCREEN FORMAT].
[FULL]	Enlarges or reduces the size using the entire display area set with [SCREEN FORMAT].

- 5) Press ▲▼ to select [INTERLOCKED].
- 6) Press ◀▶ to switch the item.

[OFF]	Sets the [VERTICAL] and [HORIZONTAL] zoom ratio.
[ON]	Uses [BOTH] to set zoom ratio. Image can be enlarged or reduced vertically and horizontally at the same magnification.

- 7) Press ▲▼ to select [VERTICAL] or [HORIZONTAL].
 - If [ON] is selected, select [BOTH].
- 8) Press ◀▶ to adjust.

Note

- When [ASPECT] is not set to [DEFAULT], [MODE] is not displayed.

[CLOCK PHASE]

You can adjust to achieve an optimal image when there is a flickering image or smeared outlines.

- 1) Press ▲▼ to select [CLOCK PHASE].
- 2) Press ◀▶ or the <ENTER> button.
 - The [CLOCK PHASE] individual adjustment screen is displayed.
- 3) Press ◀▶ to adjust.
 - Adjustment value will change between [0] and [+31]. Adjust so that the amount of interference is at a minimum.

Note

- Certain signals may not be adjustable.
- Optimal value may not be achieved if the output from the input computer is unstable.
- Optimal value may not be achieved when there is a shift in the total dot numbers.
- [CLOCK PHASE] can be adjusted only when a signal is input to the <RGB 1 IN> terminal or the <RGB 2 IN> terminal.
- [CLOCK PHASE] cannot be adjusted when a digital signal is input.
- If you press ▶ while the adjustment value is [+31], the value will become [0]. If you press ◀ while the adjustment value is [0], the value will become [+31].

[GEOMETRY]

(Only for PT-DZ13KE, PT-DS12KE, PT-DZ10KE)

You can correct various types of distortion in a projected image.

Unique image processing technology enables projection of a square image on a special screen shape.

- 1) Press ▲▼ to select [GEOMETRY].
- 2) Press ◀▶ to switch the item.
 - The items will switch each time you press the button.

[OFF]	Does not perform geometric adjustment.
[KEystone]	Adjusts any trapezoidal distortion in the projected image.
[CORNER CORRECTION]	Adjusts any distortion in the four corners of the projected image.
[CURVED]	Adjusts any curved distortion in the projected image.

[PC-1]*1	Uses the computer to perform geometric adjustment.
[PC-2]*1	
[PC-3]*1	

*1 Advanced skills are necessary to use a computer to control geometric adjustment. Consult your dealer. Up to three geometric adjustments performed using the computer can be saved.

Setting [KEYSTONE] or [CURVED]

- 1) Press ▲▼ to select [GEOMETRY].
- 2) Press ◀▶ to select [KEYSTONE] or [CURVED].
- 3) Press the <ENTER> button.
 - The [GEOMETRY:KEYSTONE] or [GEOMETRY:CURVED] screen is displayed.
- 4) Press ▲▼ to select the item to adjust.
- 5) Press ◀▶ to adjust.

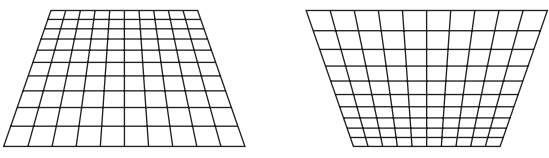
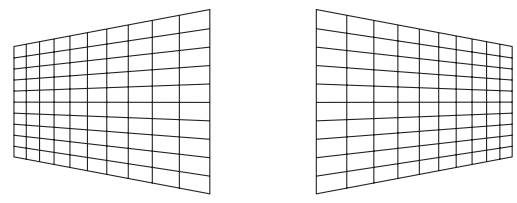
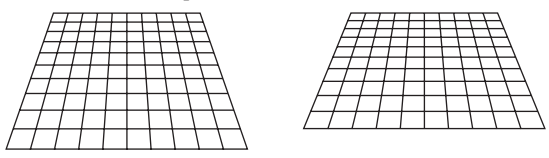
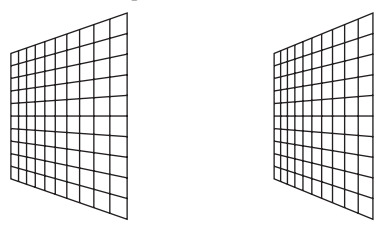
[KEYSTONE]			
[LENS THROW RATIO] Set the throw ratio for the lens used.			
[VERTICAL KEYSTONE] 	[HORIZONTAL KEYSTONE] 		
[VERTICAL BALANCE] 	[HORIZONTAL BALANCE] 		
Adjust the setting according to the lens shift range in the vertical direction.		Adjust the setting according to the lens shift range in the horizontal direction.	

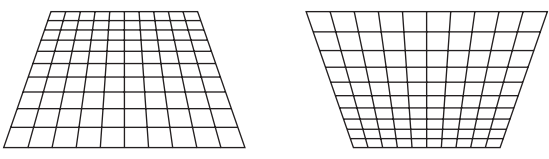
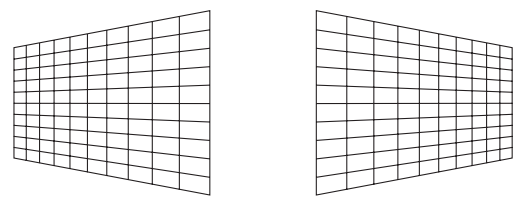
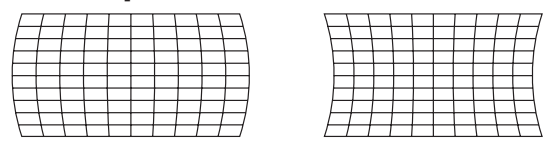
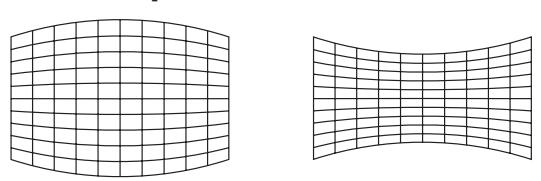
[CURVED]			
[LENS THROW RATIO] Set the throw ratio for the lens used.			
[VERTICAL KEYSTONE] 	[HORIZONTAL KEYSTONE] 		
[VERTICAL ARC] 	[HORIZONTAL ARC] 		

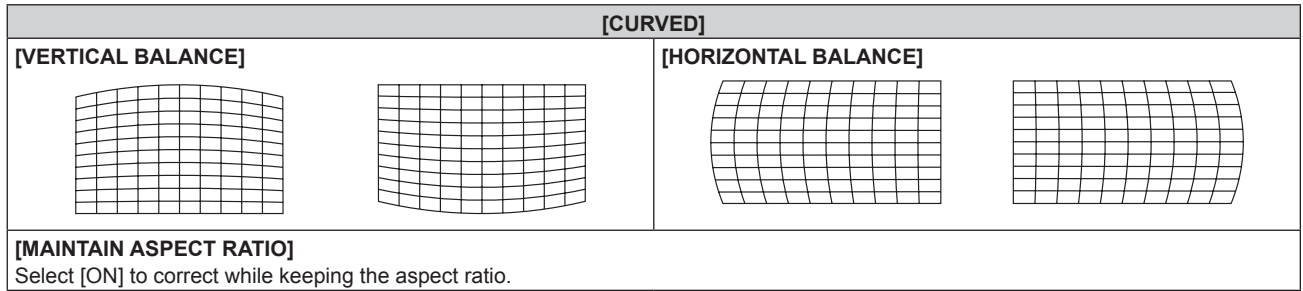

Setting [CORNER CORRECTION]

- 1) Press ▲▼ to select [GEOMETRY].
- 2) Press ◀▶ to select [CORNER CORRECTION].
- 3) Press the <ENTER> button.
 - The [GEOMETRY:CORNER CORRECTION] screen is displayed.
- 4) Press ▲▼ to select the item to adjust, and press the <ENTER> button.
- 5) Press ▲▼◀▶ to adjust.

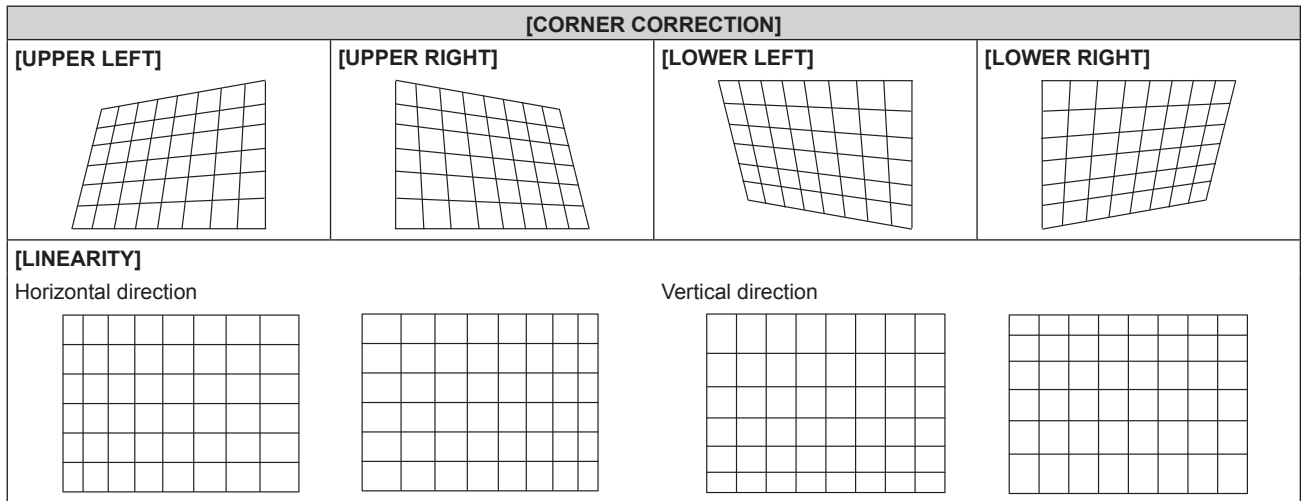

Note

- The menu or logo may run off the screen when [GEOMETRY] is set.
- If [EDGE BLENDING] (➔ page 87) adjustment and [GEOMETRY] are used together, correct edge blending adjustment may not be possible in certain environments.
- The optional Upgrade Kit (Model No.: ET-UK20) can be used to expand the correctable range. To purchase the product, consult your dealer.

[KEYSTONE]

(Only for PT-DW11KE)

You can correct the trapezoidal distortion that occurs when the projector is installed tilted or when the screen is tilted.

- 1) Press ▲▼ to select [KEYSTONE].
- 2) Press the <ENTER> button.
- 3) Press ▲▼ to select the item to adjust.
- 4) Press ◀▶ to adjust.

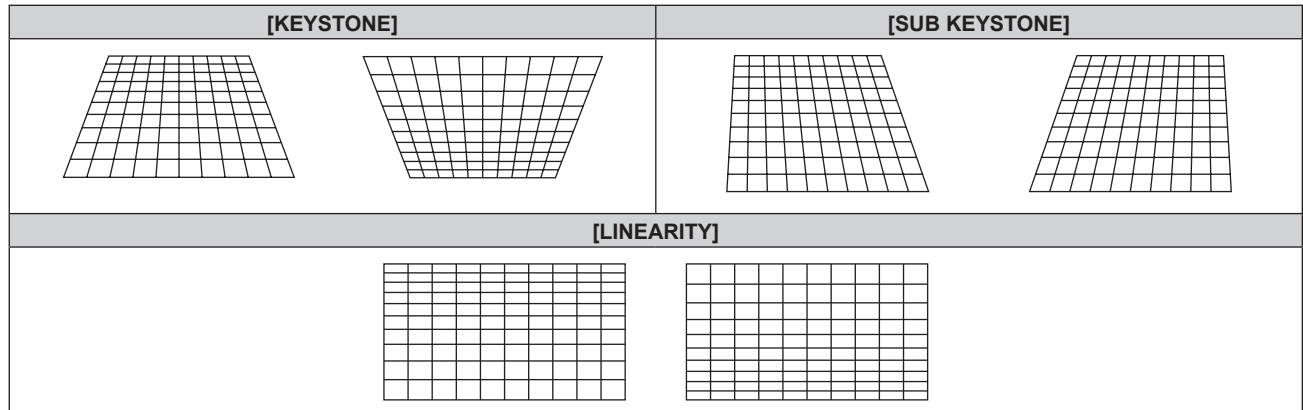
**Note**

- The menu or logo may run off the screen when adjustments are performed with [KEYSTONE].
- Correcting up to $\pm 40^\circ$ for the tilt in the vertical direction is available for adjustments with [KEYSTONE]. However, the image quality will degrade and it will get harder to focus with more correction. Install the projector so that the correction will be as small as possible. ($\pm 22^\circ$ when using projection lens ET-D75LE5/ET-D75LE50, or $\pm 28^\circ$ when using the projection lens ET-D75LE6.)
- Screen size will also change when [KEYSTONE] is used to perform various adjustments.
- When the keystone is corrected with [KEYSTONE], the edge blending cannot be adjusted together.
- Aspect ratio of the image size may shift depending on the correction or lens zoom value.
- For the portrait setting, keystone is corrected for horizontal tilt.

[ADVANCED MENU] menu

On the menu screen, select [ADVANCED MENU] from the main menu, and select an item from the sub-menu.

Refer to “Navigating through the menu” (⇒ page 65) for the operation of the menu screen.

- After selecting the item, press ▲▼◀▶ to set.

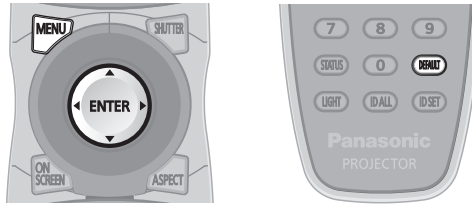

[DIGITAL CINEMA REALITY]

You can increase the vertical resolution and enhance the image quality by performing cinema processing when the PAL (or SECAM) 576i signal, the NTSC 480i signal, and 1080/50i, 1080/60i are input.

1) Press ▲▼ to select [DIGITAL CINEMA REALITY].

2) Press ◀▶ to switch the item.

- The items will switch each time you press the button.

[AUTO]	Performs automatic detection and cinema processing. (Factory default)	
[OFF]	Does not perform cinema processing.	
[25p FIXED]	Only during 576i or 1080/50i signal input	Performs forced cinema processing (2:2 pull-down).
[30p FIXED]	Only during 480i or 1080/60i signal input	

Note

- In [DIGITAL CINEMA REALITY], the picture quality will degrade when a signal other than the 2:2 pull-down is set as [25p FIXED] or [30p FIXED]. (Vertical resolution will degrade.)
- When [FRAME RESPONSE] is set to [FAST], [DIGITAL CINEMA REALITY] cannot be set.

[BLANKING]

You can adjust the blanking width if there are noises at the edge of the screen or the image is slightly running out from the screen while an image from the VCR or other devices are projected.

1) Press ▲▼ to select [BLANKING].

2) Press the <ENTER> button.

- The [BLANKING] adjustment screen is displayed.

3) Press ▲▼ to select [UPPER], [LOWER], [LEFT], or [RIGHT].

- When [CUSTOM MASKING] is set to an item ([PC-1], [PC-2], or [PC-3]) other than [OFF], the blanking width can be adjusted to any shape using the computer. Up to three blanking settings adjusted using the computer can be saved.
To use the [CUSTOM MASKING] function, the optional Upgrade Kit (Model No.: ET-UK20) is required. To purchase the product, consult your dealer.

4) Press ◀▶ to adjust the blanking width.

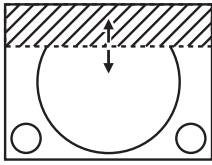
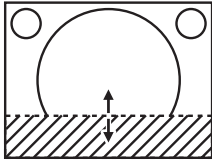
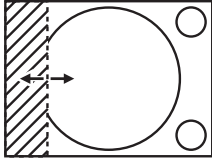
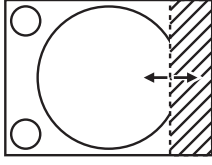
Blanking correction	Item	Operation	Adjustment	Range of adjustment	
Top of the screen	[UPPER]	Press the ◀ button.	The blanking zone moves upward.		PT-DZ13KE, PT-DZ10KE: Top to bottom 0 - 599 PT-DS12KE: Top to bottom 0 - 524 PT-DW11KE: Top to bottom 0 - 383
		Press the ▶ button.	The blanking zone moves downward.		
Bottom of the screen	[LOWER]	Press the ▶ button.	The blanking zone moves upward.		
		Press the ◀ button.	The blanking zone moves downward.		
Left side of the screen	[LEFT]	Press the ▶ button.	The blanking zone moves to the right.		PT-DZ13KE, PT-DZ10KE: Left to right 0 - 959 PT-DS12KE: Left to right 0 - 699 PT-DW11KE: Left to right 0 - 682
		Press the ◀ button.	The blanking zone moves to the left.		
Right side of the screen	[RIGHT]	Press the ◀ button.	The blanking zone moves to the right.		
		Press the ▶ button.	The blanking zone moves to the left.		

[INPUT RESOLUTION]

You can adjust to achieve an optimal image when there is a flickering image or smeared outlines.

- 1) Press ▲▼ to select [INPUT RESOLUTION].
- 2) Press the <ENTER> button.
 - The [INPUT RESOLUTION] screen is displayed.
- 3) Press ▲▼ to select [TOTAL DOTS], [DISPLAY DOTS], [TOTAL LINES], or [DISPLAY LINES], and press ◀▶ to adjust it.
 - Values corresponding to the signal being input are displayed automatically for each item. Increase or decrease the displayed values and adjust to the optimal point viewing the screen when there are vertical stripes or sections are missing from the screen.

Note

- Previously mentioned vertical banding will not occur with all white signal input.
- The image may be disrupted while performing the adjustment, but it is not a malfunction.
- [INPUT RESOLUTION] can be adjusted only when an RGB signal is input to the <RGB 1 IN> terminal or the <RGB 2 IN> terminal.
- Certain signals may not be adjustable.

[CLAMP POSITION]

You can adjust the optimal point when the black part of the image is blunt or it has turned green.

- 1) Press ▲▼ to select [CLAMP POSITION].
- 2) Press ◀▶ to adjust.

Status	Rough guide for optimal value	Range of adjustment
The black part is blunt.	The point where bluntness of the black part improves the most is the optimal value.	1 - 255
The black part is green.	The point where the green part becomes black, and the bluntness has improved is the optimal value.	

Note

- [CLAMP POSITION] can be adjusted only when a signal is input to the <RGB 1 IN> terminal or the <RGB 2 IN> terminal.
- Certain signals may not be adjustable.

[EDGE BLENDING]

The edge blending function allows multiple projector images to be seamlessly overlapped by using the inclination of the brightness at the overlapped area.

1) Press ▲▼ to select [EDGE BLENDING].

2) Press ◀▶ to switch the item.

- The items will switch each time you press the button.

[OFF]	Sets the edge blending function to off.
[ON]	Use the setting value of the internal distortion of the set for the inclination of the edge blending area.
[USER]	Use the user-setting value for the inclination of the edge blending area. (Configuration/registration requires separate software. Consult your dealer.)

- To adjust edge blending, proceed to Step 3).

3) When [ON] or [USER] is selected, press the <ENTER> button.

- The [EDGE BLENDING] screen is displayed.

4) Press ▲▼ to specify the location to be corrected.

- When joining at top: Set [UPPER] to [ON]
- When joining at bottom: Set [LOWER] to [ON]
- When joining at left: Set [LEFT] to [ON]
- When joining at right: Set [RIGHT] to [ON]

5) Press ◀▶ to switch between [ON] and [OFF].

6) Press ▲▼ to select [START] and [WIDTH].

7) Press ◀▶ to adjust the starting position and correction width.

8) Press ▲▼ to select [MARKER].

9) Press ◀▶ to switch to [ON].

- A marker for image position adjustment is displayed. The position where the red and green lines overlap for the projectors to be joined will be the optimal point. Make sure to set the correction width for the projectors to be joined with the same value. Optimal joining is not possible with projectors that have different correction widths.

The optimal point is the point at which these lines overlap.

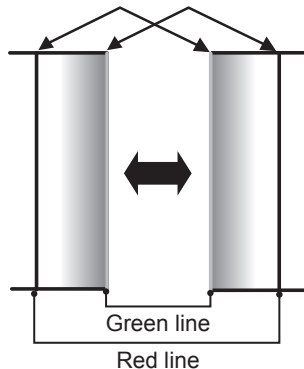

10) Press ▲▼ to select [BRIGHTNESS ADJUST].

11) Press the <ENTER> button.

- The [BRIGHTNESS ADJUST] screen is displayed.
- By setting [AUTO TESTPATTERN] on the [EDGE BLENDING] screen to [ON], the black test pattern is displayed when you enter the [BRIGHTNESS ADJUST] screen.

12) Press ▲▼ to select [NON-OVERLAPPED BLACK LEVEL].

13) Press the <ENTER> button.

- The [NON-OVERLAPPED BLACK LEVEL] screen is displayed.
- If [INTERLOCKED] is set to [OFF], [RED], [GREEN], and [BLUE] can be adjusted individually.

14) Press ▲▼ to select an item, and press ◀▶ to adjust the setting.

- Once the adjustment is completed, press the <MENU> button to return to the [BRIGHTNESS ADJUST] screen.

- 15) Press ▲▼ to select [UPPER], [LOWER], [LEFT], or [RIGHT] in [BLACK BORDER WIDTH].
- 16) Press ◀▶ to set the region (width) of the [BLACK BORDER WIDTH] adjustment.
 - When PT-DZ13KE, PT-DS12KE, or PT-DZ10KE is used, proceed to Step 17).
 - When PT-DW11KE is used, proceed to Step 19).
- 17) Press ▲▼ to select [UPPER KEYSTONE AREA], [LOWER KEYSTONE AREA], [LEFT KEYSTONE AREA], or [RIGHT KEYSTONE AREA].
- 18) Press ◀▶ to adjust the tilt of the border between [NON-OVERLAPPED BLACK LEVEL] and [BLACK BORDER LEVEL].
- 19) Press ▲▼ to select [BLACK BORDER LEVEL].
- 20) Press the <ENTER> button.
 - The [BLACK BORDER LEVEL] screen is displayed.
 - If [INTERLOCKED] is set to [OFF], [RED], [GREEN], and [BLUE] can be adjusted individually.
- 21) Press ▲▼ to select an item, and press ◀▶ to adjust the setting.

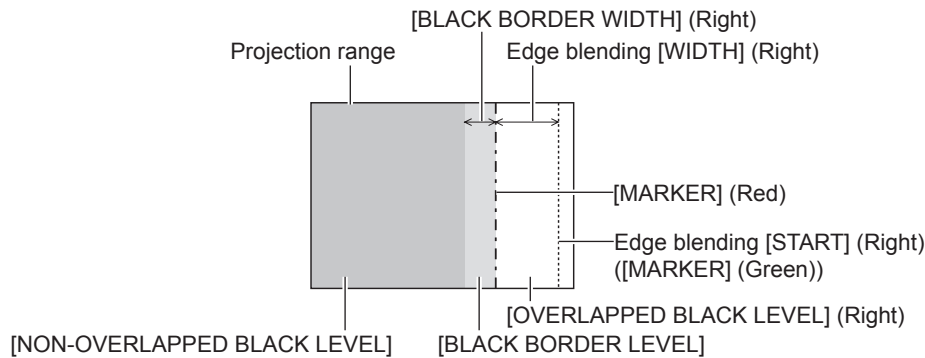

Note

- [BRIGHTNESS ADJUST] is a function that makes the increased brightness in black level of the overlapping image area difficult to notice when [EDGE BLENDING] is used to configure multiple screens. The optimal point of correction is set by adjusting [NON-OVERLAPPED BLACK LEVEL] so the black level of the overlapping image area will be the same level as the non-overlapping area. If the border area of the part where the image is overlapping and the non-overlapping part gets brighter after adjusting [NON-OVERLAPPED BLACK LEVEL], adjust the width of the top, bottom, left, or right. Adjust [BLACK BORDER LEVEL] when the width adjustment makes only the border area darker.
- The joining part may look discontinuous depending on the position you are looking from when a screen with high gain or rear screen is used.
- When configuring multiple screens using both horizontal and vertical edge blending, adjust [OVERLAPPED BLACK LEVEL] first before making adjustments in Step 12). Adjustment method is same as the procedure of [NON-OVERLAPPED BLACK LEVEL].
- If only horizontal or vertical edge blending is used, set all items in [OVERLAPPED BLACK LEVEL] to 0.
- [AUTO TESTPATTERN] settings change together with the [AUTO TESTPATTERN] of [COLOR MATCHING].
- Adjustment of the tilt of the border between [NON-OVERLAPPED BLACK LEVEL] and [BLACK BORDER LEVEL] is a function to perform the adjustment of [GEOMETRY] (➔ page 81) together with the edge blending. If [NON-OVERLAPPED BLACK LEVEL] is tilted by correcting the keystone from [KEYSTONE] in [GEOMETRY], perform Steps 17) and 18) to adjust the edge blending according to the shape of [NON-OVERLAPPED BLACK LEVEL].
- When the keystone is corrected with [KEYSTONE], the edge blending cannot be adjusted together. (Only for PT-DW11KE)

[FRAME RESPONSE]

Set image frame delay.

- 1) Press ▲▼ to select [FRAME RESPONSE].
- 2) Press ◀▶ to switch the item.
 - The items will switch each time you press the button.

[NORMAL]	Standard setting.
[FAST]*1	Simplifies the image processing to reduce image frame delay.
[FIXED]*2	Sets image frame delay to be constant regardless of the image position or magnification.

*1 When input signals are other than interlaced signals, [FAST] cannot be set.

*2 Only when movie-based signals and still image signals with the vertical scanning frequency of 50 Hz or 60 Hz are input

Note

- When [FRAME RESPONSE] is set to [FAST], picture quality deteriorates. Also, [DIGITAL CINEMA REALITY] cannot be set.
- [FRAME RESPONSE] cannot be set during P IN P.

[FRAME LOCK]

(Only for PT-DZ13KE, PT-DS12KE, PT-DZ10KE)

Set this to view 3D display when the vertical scanning frequency of the signal is 25 Hz, 50 Hz, and 100 Hz.

1) Press ▲▼ to select [FRAME LOCK].

2) Press ◀▶ to switch the item.

- The items will switch each time you press the button.

[OFF]	Decreases the flickering of the display.
[ON]	Synchronizes the display to the vertical scanning frequency of the input signal.

Note

- [FRAME LOCK] is not displayed when the vertical scanning frequency of a signal other than the above is input or 2D images are displayed.
- The screen may flicker when [FRAME LOCK] is set to [ON].
- The display may look discontinuous when [FRAME LOCK] is set to [OFF].

[RASTER POSITION]

This will allow the position of the image to move within the display area arbitrarily when the input image is not using the whole display area.

1) Press ▲▼ to select [RASTER POSITION].

2) Press the <ENTER> button.

- The [RASTER POSITION] screen is displayed.

3) Press ▲▼◀▶ to adjust the position.

[DISPLAY LANGUAGE] menu

On the menu screen, select [DISPLAY LANGUAGE] from the main menu, and display the sub-menu.

Refer to “Navigating through the menu” (➔ page 65) for the operation of the menu screen.

- Press ▲▼ to select a language, and press the <ENTER> button to set.

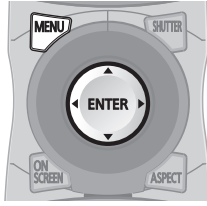

Changing the display language

You can select the language of the on-screen display.



- Various menus, settings, adjustment screens, control button names, etc., are displayed in the selected language.
- The language can be changed to English, German, French, Spanish, Italian, Portuguese, Japanese, Chinese, Russian, or Korean.

Note

- The on-screen display language of the projector is set to English by default and when [ALL USER DATA] (➔ page 124) in [INITIALIZE] is executed.

[3D SETTINGS] menu

(Only for PT-DZ13KE, PT-DS12KE, PT-DW11KE)

On the menu screen, select [3D SETTINGS] from the main menu, and select an item from the sub-menu.

Refer to “Navigating through the menu” (➔ page 65) for the operation of the menu screen.

- After selecting the item, press ▲▼◀▶ to set.

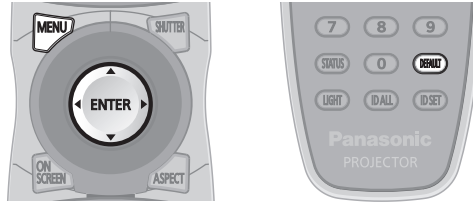

[3D SYSTEM SETTING]

Set a picture display method for use during 3D signal input as necessary for the 3D system in use.

1) Press ▲▼ to select [3D SYSTEM SETTING].

2) Press ◀▶ to switch the item.

- The items will switch each time you press the button.

[SINGLE]	During 3D signal input, sequential frames of images for the right eye and images for the left eye are alternately displayed.
[DUAL (LEFT)]	Only images for the left eye are displayed during 3D signal input.
[DUAL (RIGHT)]	Only images for the right eye are displayed during 3D signal input.

Note

- When 2D images are input, 2D images are displayed regardless of [3D SYSTEM SETTING] settings.

[3D SYNC SETTING]

Set the way in which the <3D SYNC 1 IN/OUT> terminal and the <3D SYNC 2 OUT> terminal will be used.

Attention

- Before connecting external devices to the <3D SYNC 1 IN/OUT> terminal and the <3D SYNC 2 OUT> terminal using cables, complete the [3D SYNC MODE] setting and confirm that the external devices to be connected are turned off.
- Changing [3D SYNC MODE] while the cables are connected may result in malfunctions of the projector or the connected external devices.

1) Press ▲▼ to select [3D SYNC SETTING].

2) Press the <ENTER> button.

- The precaution message related to [3D SYNC SETTING] is displayed.

3) Press the <ENTER> button.

- The [3D SYNC SETTING] screen is displayed.

4) Press ▲▼ to select [3D SYNC MODE].

5) Press ◀▶ to switch the item.

[3D SYNC MODE]	Items set in [3D SYNC1]	Items set in [3D SYNC2]
[OFF]	Not used.	Not used.
[1]	3D trigger output	Stereo synch output
[2]	3D trigger output	3D trigger output
[3]	Stereo synch input	Through 3D SYNC1
[4]	Stereo synch input	Stereo synch output
[5]	Stereo synch input	3D trigger output
[6]	Frame synch input	Through 3D SYNC1
[7]	Frame synch input	Stereo synch output
[8]	Frame synch input	3D trigger output
[9]	3D trigger output	Frame synch output

[3D SYNC MODE]	Items set in [3D SYNC1]	Items set in [3D SYNC2]
[10]	Stereo synch output	Frame synch output
[11]	3D IR TRANSMITTER (+) output	3D IR TRANSMITTER (-) output

- 6) When [1], [4], [7], or [10] is selected, press ▲▼ to select [STEREO SYNC OUTPUT DELAY], and press ◀▶ to set the amount of delay output.

[0us] - [25 000 us]	Allows you to set in increments of 10 us.
---------------------	---

- To synchronize multiple projectors to display 3D images, use a frame synch input and output.
Select [9] or [10] for the first projector.
Select [6], [7], or [8] for the second and subsequent projectors.
- Stereo synchronization is a signal having a 50 % duty cycle where High is for the left eye and Low is for the right eye.
- “H” is output to the 3D image display and “L” is output to the 2D image display from the terminal for which 3D trigger output is selected.

Note

- [11] or [3D SYNC MODE] is the setting when the 3D IR TRANSMITTER TY-3DTRW of Panasonic is used with the projector. Consult your dealer regarding the connection method.

[3D SIMUL INPUT SETTING]

Set this item to input and use 3D video signals of the simultaneous system.

- 1) Press ▲▼ to select [3D SIMUL INPUT SETTING].
- 2) Press the <ENTER> button.
 - The [3D SIMUL INPUT SETTING] screen is displayed.
- 3) Press ▲▼ to select [LEFT:RGB1 RIGHT:RGB2], [LEFT:HDMI RIGHT:DVI-D], or [LEFT:SDI1 RIGHT:SDI2] (only for PT-DZ13KE, PT-DS12KE).
- 4) Press ◀▶ to switch the setting.

[OFF]	Cannot use 3D simultaneous.
[AUTO]	Displays 3D images of the simultaneous system.

Note

- When set to [AUTO], 3D images are displayed when the same 3D compatible signals are entered to each input. However, the P IN P status during P IN P is maintained.
- This may not function properly for some connected external devices.
- Certain signals may not function properly.

[3D INPUT FORMAT]

Set the 3D format for the image signals being input.

Set a 3D format that matches the input signal.

- 1) Press ▲▼ to select [3D INPUT FORMAT].
- 2) Press the <ENTER> button.
 - The [3D INPUT FORMAT] screen is displayed.
- 3) Press ▲▼ to select a 3D format.

[AUTO] ^{*1}	Automatically detects 3D format of input image signals and displays images.
[NATIVE]	Forcibly displays 2D images regardless of input image signals.
[SIMULTANEOUS] ^{*2}	Forcibly displays 3D images in simultaneous system regardless of input video signals.
[SIDE BY SIDE]	Forcibly displays 3D images in side by side format regardless of input image signals.
[TOP AND BOTTOM]	Forcibly displays 3D images in top and bottom format regardless of input image signals.
[LINE BY LINE] ^{*3}	Forcibly displays 3D images in line by line system regardless of input video signals.
[FRAME SEQUENTIAL] ^{*4}	Forcibly displays 3D images in frame sequential format regardless of input image signals.

*1 During DVI-D or HDMI input only

*2 During 3G-SDI level B input only

*3 Only while signals other than interlaced signals are input

*4 Only while progressive signals with the vertical scanning frequency of 100 Hz or 120 Hz are input to the <RGB1>/<RGB2>/<DVI-D> terminals

- 4) Press the <ENTER> button.

Note

- When set to [AUTO], [SIMULTANEOUS], [SIDE BY SIDE], [TOP AND BOTTOM], [LINE BY LINE], or [FRAME SEQUENTIAL], 3D images are not displayed in [3D SIMUL INPUT SETTING]. In [AUTO], however, this only occurs when 3D format can be recognized.
- This may not function properly for some connected external devices.

[LEFT/RIGHT SWAP]

Display images by inverting the timing of horizontal image switching. Change the settings when there is something wrong with the 3D image being viewed.

1) Press ▲▼ to select [LEFT/RIGHT SWAP].

2) Press ◀▶ to switch the item.

- The items will switch each time you press the button.

[NORMAL]	Do not change the [NORMAL] setting if the 3D images are displayed correctly.
[SWAPPED]	Select this when left and right 3D images are swapped to be displayed.

Note

- This is disabled when [3D SYSTEM SETTING] is set to other than [SINGLE].

[3D COLOR MATCHING]

Switches the color matching correction data applied to the displayed image.

1) Press ▲▼ to select [3D COLOR MATCHING].

2) Press ◀▶ to switch the item.

- The items will switch each time you press the button.

[SHARED 2D/3D]	2D signals and 3D signals use the same correction data.
[SEPARATE 2D/3D]	2D signals and 3D signals use different correction data.

Note

- Switch the setting of [COLOR MATCHING] (➔ page 96) while inputting the signal to be adjusted.

[3D PICTURE BALANCE]

Correct a shift when the brightness or color differ in the right eye and left eye images.

1) Press ▲▼ to select [3D PICTURE BALANCE].

2) Press the <ENTER> button.

- The [3D PICTURE BALANCE] screen is displayed.

3) Press ▲▼ to select an item, and press ◀▶ to adjust the setting.

- Correct the setting value parts of the right eye image based on the left eye image.
- For [3D WAVEFORM MONITOR], the left eye and right eye images are divided and displayed in a waveform on the left and right.

[CONTRAST]	Adjusts the contrast of the colors.
[WHITE BALANCE HIGH RED]	Adjusts the high red white balance.
[WHITE BALANCE HIGH GREEN]	Adjusts the high green white balance.
[WHITE BALANCE HIGH BLUE]	Adjusts the high blue white balance.
[BRIGHTNESS]	Adjusts the dark (black) part of the projected image.
[WHITE BALANCE LOW RED]	Adjusts the low red white balance.
[WHITE BALANCE LOW GREEN]	Adjusts the low green white balance.
[WHITE BALANCE LOW BLUE]	Adjusts the low blue white balance.
[COLOR]	Adjusts the color saturation of the projected image.
[TINT]	Adjusts the skin tone in the projected image.
[CLOCK PHASE]	Adjusts when the screen flickers or outline blurs.

[3D WAVEFORM MONITOR]	[OFF]	Hides the 3D waveform monitor.
	[ON]	Displays the 3D waveform monitor.

Note

- The [CLOCK PHASE] setting is enabled at simultaneous input of RGB1 and RGB2 to adjust the right eye image.
- This is disabled when [3D SYSTEM SETTING] is set to other than [SINGLE].
- This is disabled when [3D TEST PATTERN] is displayed.
- This is disabled when [3D TEST MODE] is set to other than [NORMAL] or [SIDE BY SIDE].
- The 3D waveform monitor is displayed only when the [3D PICTURE BALANCE] screen is displayed.
- The normal waveform monitor cannot be displayed in 3D images.

[DARK TIME SETTING]

Set the black display period to be displayed between the right eye image and the left eye image as necessary for the 3D system used.

1) Press ▲▼ to select [DARK TIME SETTING].

2) Press ◀▶ to switch the item.

- The items will switch each time you press the button.

[0.5 ms]	Set so that the 3D setting is displayed correctly.
[1.0 ms]	
[1.5 ms]	
[2.0 ms]	
[2.5 ms]	
[2.7 ms]	

Note

- This is disabled when [3D SYSTEM SETTING] is set to other than [SINGLE].
- When the setting does not correspond to the 3D system in use, phenomenon such as increased crosstalk and darkening of displayed images may occur.

[3D FRAME DELAY]

Adjust the timing of the left-right switch of an image.

1) Press ▲▼ to select [3D FRAME DELAY].

2) Press ◀▶ to switch the item.

[0us] - [25 000 us]	Allows you to set in increments of 10 us.
---------------------	---

- The adjustment range depends on the input signal.

[3D TEST MODE]

Set the image display system for use with 3D system adjustments.

1) Press ▲▼ to select [3D TEST MODE].

2) Press ◀▶ to switch the item.

[NORMAL]	Standard setting.
[SIDE BY SIDE]	The left eye image is displayed on the left, next to the right eye image displayed on the right.
[LEFT/LEFT]	Both the left eye image and right eye image display the left eye input signal.
[RIGHT/RIGHT]	Both the left eye image and right eye image display the right eye input signal.
[LEFT/BLACK]	The left eye input signal is displayed in the left eye image and a completely black image is displayed in the right eye image.
[BLACK/RIGHT]	A completely black image is displayed in the left eye image and the right input signal is displayed in the right eye image.

Note

- The [3D TEST MODE] settings return to [NORMAL] when the projector is switched off.
- This is disabled when [3D SYSTEM SETTING] is set to other than [SINGLE].
- This is disabled when [3D TEST PATTERN] is displayed.

[3D TEST PATTERN]

The 3D test pattern can be used to check operation and make adjustments even without a 3D signal.

- 1) Press ▲▼ to select [3D TEST PATTERN].
- 2) Press ◀▶ to switch the item.

Menu screen + Entry screen	Select a test pattern so that it is easy to check operations and make adjustments.
Menu screen + Left: white/ Right: black	
Menu screen + Left: black/ Right: white	

Note

- The 3D test pattern cannot be displayed when the following inputs are selected.
 - VIDEO input
 - RGB1 input (only when [RGB IN] is set to [Y/C])
- This is disabled when [3D SYSTEM SETTING] is set to other than [SINGLE].

[SAFETY PRECAUTIONS MESSAGE]

Set to show or hide the safety precautions message related to 3D viewing when the projector is switched on.

- 1) Press ▲▼ to select [SAFETY PRECAUTIONS MESSAGE].
- 2) Press ◀▶ to switch the item.
 - The items will switch each time you press the button.

[ON]	Shows the safety precautions message related to 3D viewing when the projector is switched on.
[OFF]	Hides the safety precautions message related to 3D viewing when the projector is switched on.

Note

- Set to [OFF] to hide the safety precautions message related to 3D viewing when the projector is switched on.
- A confirmation screen is displayed when switched from [ON] to [OFF]. Press ◀▶ to select [OK], and press the <ENTER> button to change the setting to [OFF].

Attention

- When 3D images are viewed by unspecified number of people for commercial use, display the safety precautions message related to 3D viewing to notify viewers.

[3D SAFETY PRECAUTIONS]

Show the safety precautions message related to 3D viewing.

- 1) Press ▲▼ to select [3D SAFETY PRECAUTIONS].
- 2) Press the <ENTER> button.
 - The [3D SAFETY PRECAUTIONS] screen is displayed.
 - Press ◀▶ to switch the page.

3D SAFETY PRECAUTIONS 1/2	3D SAFETY PRECAUTIONS 2/2
<p>If you view 3D images, please note below. In addition, when 3D images will be viewed by unspecified number of people or used for commercial applications, someone in authority should convey the following precautions.</p> <p>To enjoy 3D images safely and comfortably, please refer to the Operating Instructions for in-depth description.</p>	<p>Please refrain from viewing 3D images if you do not feel well or are experiencing visual fatigue. Please use the contents which has been properly made for 3D. View from at least the recommended distance. (3 times the effective height of the screen)</p> <p>Refer to the Operating Instructions if this message is no longer needed.</p>
◀▶ CHANGE MENU EXIT	◀▶ CHANGE MENU EXIT

[DISPLAY OPTION] menu

On the menu screen, select [DISPLAY OPTION] from the main menu, and select an item from the sub-menu.

Refer to “Navigating through the menu” (➔ page 65) for the operation of the menu screen.

- After selecting the item, press ▲▼◀▶ to set.

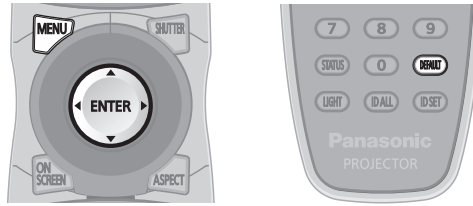

[COLOR MATCHING]

Correct the color difference between projectors when using multiple projectors simultaneously.

Adjusting the color matching as desired

1) Press ▲▼ to select [COLOR MATCHING].

2) Press ◀▶ to switch the item.

- The items will switch each time you press the button.

[OFF]	Color matching adjustment is not carried out.
[3COLORS]	Adjusts the three colors [RED], [GREEN], or [BLUE].
[7COLORS]	Adjusts the seven colors [RED], [GREEN], [BLUE], [CYAN], [MAGENTA], [YELLOW], or [WHITE].
[709MODE]	
[MEASURED]	Refer to “Adjusting the color matching using a colorimeter” (➔ page 97) for details about this mode.

3) Select [3COLORS] or [7COLORS], and press the <ENTER> button.

- The [3COLORS] or [7COLORS] screen is displayed.

4) Press ▲▼ to select [RED], [GREEN], or [BLUE] ([RED], [GREEN], [BLUE], [CYAN], [MAGENTA], [YELLOW], or [WHITE] for [7COLORS]).

5) Press the <ENTER> button.

- The [3COLORS:RED], [3COLORS:GREEN], or [3COLORS:BLUE] screen is displayed.
For [7COLORS], the [7COLORS:RED], [7COLORS:GREEN], [7COLORS:BLUE], [7COLORS:CYAN], [7COLORS:MAGENTA], [7COLORS:YELLOW], or [7COLORS:WHITE] screen is displayed.
- Set [AUTO TESTPATTERN] to [ON] to display a test pattern of selected colors.

6) Press ▲▼ to select [RED], [GREEN], or [BLUE].

7) Press ◀▶ to adjust.

- The adjustment value changes between 0 and 2 048.

Note

- Operation when correcting the adjustment color
When the correction color same as the adjustment color is changed: The luminance of the adjustment color changes.
When correction color red is changed: Red is added to or subtracted from the adjustment color.
When correction color green is changed: Green is added to or subtracted from the adjustment color.
When correction color blue is changed: Blue is added to or subtracted from the adjustment color.
- This adjustment should be carried out by a person who is familiar with the projector or by a service person because a high level of skill is required to make a successful adjustment.
- Pressing the <DEFAULT> button will restore the factory default settings for all items.
- When [COLOR MATCHING] is set to other than [OFF], [COLOR TEMPERATURE] is fixed to [USER1].
- Set [3D COLOR MATCHING] (➔ page 93) to set whether 2D and 3D signals are set separately or whether common data is used. (Only for PT-DZ13KE, PT-DS12KE, PT-DW11KE)
- When 2D and 3D settings are set separately, [NATIVE] or [3D] is displayed in the upper right of the menu. (Only for PT-DZ13KE, PT-DS12KE, PT-DW11KE)

Adjusting the color matching using a colorimeter

Use a colorimeter that can measure chromaticity coordinates and luminance to change the colors [RED], [GREEN], [BLUE], [CYAN], [MAGENTA], [YELLOW], or [WHITE] to desired colors.

- 1) Press ▲▼ to select [COLOR MATCHING].
- 2) Press ◀▶ to select [709MODE] or [MEASURED].
- 3) Press the <ENTER> button.
 - The [709MODE] or [MEASURED MODE] screen is displayed.
- 4) Press ▲▼ to select [MEASURED DATA].
- 5) Press the <ENTER> button.
 - The [MEASURED DATA] screen is displayed.
- 6) Measure the current luminance (Y) and the chromaticity coordinates (x, y) using the colorimeter.
- 7) Press ▲▼ to select a color, and press ◀▶ to adjust the setting.
 - Set [AUTO TESTPATTERN] to [ON] to display a test pattern of selected colors.
- 8) Once all the input is completed, press the <MENU> button.
 - The [709MODE] or [MEASURED MODE] screen is displayed.
 - When [MEASURED] is selected in Step 2), proceed to Step 9) and enter the coordinates of desired colors.
- 9) Press ▲▼ to select [TARGET DATA].
- 10) Press the <ENTER> button.
 - The [TARGET DATA] screen is displayed.
- 11) Press ▲▼ to select a color and press ◀▶ to input coordinates for desired colors.
 - Set [AUTO TESTPATTERN] to [ON] to display a test pattern of selected colors.
- 12) Once all the input is completed, press the <MENU> button.

Note

- When [709MODE] is selected in [COLOR MATCHING], the ITU-R BT.709 standard three primary colors are set as target data.
- Colors are not displayed properly when target data is a color outside the region of this projector.
- The [709MODE] may differ slightly from the ITU-R BT.709 standard colors.
- Set the [AUTO TESTPATTERN] to [ON] to automatically display a test pattern for use in adjusting the selected adjustment colors.
- Before using a colorimeter or similar instrument to measure measurement data, set [PICTURE MODE] to [DYNAMIC].
- A difference in the color coordinates of target data and measurement values obtained from an instrument may occur for certain instruments and measurement environments used.
- [AUTO TESTPATTERN] settings change together with the [AUTO TESTPATTERN] of [EDGE BLENDING].

[LARGE SCREEN CORRECTION]

Corrects the phenomenon in which colors that appear lighter when viewed on a large screen viewed from a close distance compared to when viewed on an average screen size so that colors appear the same.

- 1) Press ▲▼ to select [LARGE SCREEN CORRECTION].
- 2) Press ◀▶ to switch the item.

[OFF]	Performs no correction.
[1]	Performs weak correction.
[2]	Performs strong correction.

[SCREEN SETTING]

(Only for PT-DZ13KE, PT-DS12KE, PT-DZ10KE)

Set the screen size.

When changing the aspect of a projected image, correct to the optimum image position for the set screen. Set as necessary for the screen in use.

- 1) Press ▲▼ to select [SCREEN SETTING].
- 2) Press the <ENTER> button.
 - The [SCREEN SETTING] screen is displayed.

3) Press ◀▶ to switch the [SCREEN FORMAT] item.

- The items will switch each time you press the button.

Model No.	[SCREEN FORMAT]	Range when [SCREEN POSITION] is selected
PT-DZ13KE, PT-DZ10KE	[16:10]	Cannot be adjusted.
	[4:3]	Adjusts the horizontal position between -160 and 160.
	[16:9]	Adjusts the vertical position between -60 and 60.
PT-DS12KE	[4:3]	Cannot be adjusted.
	[16:9]	Adjusts the vertical position between -132 and 131.

4) Press ▲▼ to select [SCREEN POSITION].

- If [SCREEN FORMAT] is set to [16:10] in PT-DZ13KE and PT-DZ10KE, or [SCREEN FORMAT] is set to [4:3] in PT-DS12KE, then selection and adjustment of [SCREEN POSITION] are not available.

5) Press ◀▶ to adjust [SCREEN POSITION].

[AUTO SIGNAL]

Set whether to execute automatic setup of signals automatically.

The screen display position or signal level can be adjusted automatically without pressing the <AUTO SETUP> button on the remote control on each occasion if you input unregistered signals frequently at meetings, etc.

1) Press ▲▼ to select [AUTO SIGNAL].

2) Press ◀▶ to switch the item.

- The items will switch each time you press the button.

[OFF]	Sets the auto signal function to off.
[ON]	Executes automatic setup automatically when images are changed to unregistered signals during projection.

[AUTO SETUP]

Set this when adjusting a special signal or horizontally long (such as 16:9) signal.

Setting with [MODE]

1) Press ▲▼ to select [AUTO SETUP].

2) Press the <ENTER> button.

- The [AUTO SETUP] screen is displayed.

3) Press ▲▼ to select [MODE].

4) Press ◀▶ to switch the item.

- The items will switch each time you press the button.

[DEFAULT]	Standard setting.
[WIDE]	Select when an image aspect is a wide-screen signal, which does not meet the [DEFAULT] settings.
[USER]	Select when receiving a signal with a special horizontal resolution (number of display dots).

- When [DEFAULT] or [WIDE] is selected, proceed to Step 7).
- When [USER] is selected, proceed to Step 5).

5) Press ▲▼ to select [DISPLAY DOTS], and press ◀▶ to adjust [DISPLAY DOTS] to the horizontal resolution of the signal source.

6) Press ▲▼ to select [MODE].

7) Press the <ENTER> button.

- Automatic adjustment is executed. [PROGRESS] is displayed while automatically adjusting. When complete, the system returns to the [AUTO SETUP] screen.

Adjusting position automatically

1) Press ▲▼ to select [AUTO SETUP].

- 2) Press the <ENTER> button.
 - The [AUTO SETUP] screen is displayed.
- 3) Press ▲▼ to select [POSITION ADJUST].
- 4) Press ◀▶ to switch the item.

[OFF]	Does not perform automatic adjustment.
[ON]	Adjust the screen position and size when automatic setup is executed.

Adjusting signal level automatically

- 1) Press ▲▼ to select [AUTO SETUP].
- 2) Press the <ENTER> button.
 - The [AUTO SETUP] screen is displayed.
- 3) Press ▲▼ to select [SIGNAL LEVEL ADJUST].
- 4) Press ◀▶ to switch the item.

[OFF]	Does not perform automatic adjustment.
[ON]	Adjusts black level (on-screen menu [BRIGHTNESS]) and white level (on-screen menu [CONTRAST]) when automatic setup is executed.

Note

- [SIGNAL LEVEL ADJUST] may not function properly unless a still image containing clear blacks and whites is input.

[RGB IN]

Set to match the signal to input to the <RGB 1 IN> terminal.

Setting [RGB1 INPUT SETTING]

- 1) Press ▲▼ to select [RGB IN].
- 2) Press the <ENTER> button.
 - The [RGB IN] screen is displayed.
- 3) Press ▲▼ to select [RGB1 INPUT SETTING].
- 4) Press ◀▶ to switch the item.
 - The items will switch each time you press the button.

[RGB/YP _B P _R]	Select when inputting an RGB signal or YC _B C _R /YP _B P _R signals to the <RGB 1 IN> terminal.
[Y/C]	Select when inputting a luminance signal and color signal to the <RGB 1 IN> terminal.

Switching the slice level of an input sync signal

- 1) Press ▲▼ to select [RGB IN].
- 2) Press the <ENTER> button.
 - The [RGB IN] screen is displayed.
- 3) Press ▲▼ to select [RGB1 SYNC SLICE LEVEL] or [RGB2 SYNC SLICE LEVEL].
- 4) Press ◀▶ to switch the item.

[LOW]	Sets the slice level to [LOW].
[HIGH]	Sets the slice level to [HIGH].

[DVI-D IN]

Switch the setting when the external device is connected to the <DVI-D IN> terminal of the projector and the image is not projected correctly.

- 1) Press ▲▼ to select [DVI-D IN].
- 2) Press the <ENTER> button.
 - The [DVI-D IN] screen is displayed.
- 3) Press ▲▼ to select [EDID].
- 4) Press ◀▶ to switch the item.
 - The items will switch each time you press the button.

[EDID3]	Recognizes movie-based video signals and still image signals automatically.
[EDID1]	Select mainly when an external device that outputs movie-based video signals (such as a blu-ray disc player) is connected to the <DVI-D IN> terminal.
[EDID2:PC]	Select mainly when an external device that outputs still image signals (such as a computer) is connected to the <DVI-D IN> terminal.

- 5) Press ▲▼ to select [SIGNAL LEVEL].
- 6) Press ◀▶ to switch the item.
 - The items will switch each time you press the button.

[AUTO]	Automatically sets the signal level.
[0-255:PC]	Select when an external device (such as a computer) is connected via the DVI-D terminal output.
[16-235]	Select when an external device (such as a blu-ray disc player) is connected via the HDMI terminal output using a conversion cable, etc.

Note

- The optimal setting varies depending on the output setting of the connected external device. Refer to the operating instructions of the external device regarding the output of the external device.
- The data for Plug and play will change when the setting is changed. Refer to “List of compatible signals” (➡ page 177) for a resolution that supports plug and play.

[HDMI IN]

Switch the setting when the external device is connected to the <HDMI IN> terminal of the projector and the image is not projected correctly.

- 1) Press ▲▼ to select [HDMI IN].
- 2) Press the <ENTER> button.
 - The [HDMI IN] screen is displayed.
- 3) Press ◀▶ to switch the [SIGNAL LEVEL] item.
 - The items will switch each time you press the button.

[AUTO]	Automatically sets the signal level.
[64-940]	Select when the HDMI terminal of an external device (such as a blu-ray disc player) is connected to the <HDMI IN> terminal.
[0-1023]	Select when the DVI-D terminal output of an external device (such as a computer) is connected to the <HDMI IN> terminal via a conversion cable or similar cable. Select also when the HDMI terminal output of a computer or other device is connected to the <HDMI IN> terminal.

Note

- The optimal setting varies depending on the output setting of the connected external device. Refer to the operating instructions of the external device regarding the output of the external device.
- The HDMI signal level is displayed for every 30 bits of input.

[SDI IN]

(Only for PT-DZ13KE, PT-DS12KE, PT-DZ10KE)

Set to match the signal to input to the <SDI IN 1>/<SDI IN 2> terminals (PT-DZ13KE, PT-DS12KE) or <SDI IN> terminal (PT-DZ10KE).

Setting [SDI LINK]

(Only for PT-DZ13KE, PT-DS12KE)

- 1) Press ▲▼ to select [SDI IN].
- 2) Press the <ENTER> button.
 - The [SDI IN] screen is displayed.
- 3) Press ▲▼ to select [SDI LINK].
- 4) Press ◀▶ to switch the item.

[SINGLE LINK]	Sets SDI1 input and SDI2 input to single link.
[DUAL LINK]	Sets SDI1 input and SDI2 input to dual link.

Setting [SIGNAL LEVEL]

Select the amplitude of the signal to input.

- 1) Press ▲▼ to select [SDI IN].
- 2) Press the <ENTER> button.
 - The [SDI IN] screen is displayed.
- 3) Press ▲▼ to select [SIGNAL LEVEL].
- 4) Press ◀▶ to switch the item.

[64-940]	Normally use this setting.
[4-1019]	Select when gray is displayed as black.

Setting [BIT DEPTH]

- 1) Press ▲▼ to select [SDI IN].
- 2) Press the <ENTER> button.
 - The [SDI IN] screen is displayed.
- 3) Press ▲▼ to select [BIT DEPTH].
- 4) Press ◀▶ to switch the item.

[AUTO]	Automatically select 12 bits or 10 bits.
[12-bit]	Fix to 12 bits.
[10-bit]	Fix to 10 bits.

Setting [3G-SDI MAPPING]

- 1) Press ▲▼ to select [SDI IN].
- 2) Press the <ENTER> button.
 - The [SDI IN] screen is displayed.
- 3) Press ▲▼ to select [3G-SDI MAPPING].
- 4) Press ◀▶ to switch the item.

[AUTO]	Automatically select level A or level B.
[LEVEL A]	Fix to level A.
[LEVEL B]	Fix to level B.

Note

- Does not operate during SD-SDI or HD-SDI input.

[ON-SCREEN DISPLAY]

Set the on-screen display.

Setting [OSD POSITION]

Set the position of the menu screen (OSD).

- 1) Press ▲▼ to select [ON-SCREEN DISPLAY].
- 2) Press the <ENTER> button.
 - The [ON-SCREEN DISPLAY] screen is displayed.
- 3) Press ▲▼ to select [OSD POSITION].
- 4) Press ◀▶ to switch the item.
 - The items will switch each time you press the button.

[2]	Sets to the center left of the screen.
[3]	Sets to the bottom left of the screen.
[4]	Sets to the top center of the screen.
[5]	Sets to the center of the screen.
[6]	Sets to the bottom center of the screen.
[7]	Sets to the upper right of the screen.
[8]	Sets to the center right of the screen.
[9]	Sets to the bottom right of the screen.
[1]	Sets to the upper left of the screen.

Setting [OSD DESIGN]

Set the color of the menu screen (OSD).

- 1) Press ▲▼ to select [ON-SCREEN DISPLAY].
- 2) Press the <ENTER> button.
 - The [ON-SCREEN DISPLAY] screen is displayed.
- 3) Press ▲▼ to select [OSD DESIGN].
- 4) Press ◀▶ to switch the item.
 - The items will switch each time you press the button.

[1]	Sets to yellow.
[2]	Sets to blue.
[3]	Sets to white.
[4]	Sets to green.
[5]	Sets to peach.
[6]	Sets to brown.

Setting [OSD MEMORY]

Set hold for the position of the menu screen (OSD) cursor.

- 1) Press ▲▼ to select [ON-SCREEN DISPLAY].
- 2) Press the <ENTER> button.
 - The [ON-SCREEN DISPLAY] screen is displayed.
- 3) Press ▲▼ to select [OSD MEMORY].
- 4) Press ◀▶ to switch the item.
 - The items will switch each time you press the button.

[ON]	Holds the cursor position.
[OFF]	Does not hold the cursor position.

Note

- Even if [OSD MEMORY] is set to [ON], the cursor position will not be held when the <MAIN POWER> switch of the projector body is turned <OFF>.

Setting [INPUT GUIDE]

Set whether to display the input guide (input terminal name, signal name, and memory number currently selected) in the position set in the [OSD POSITION].

- 1) Press ▲▼ to select [ON-SCREEN DISPLAY].
- 2) Press the <ENTER> button.
 - The [ON-SCREEN DISPLAY] screen is displayed.
- 3) Press ▲▼ to select [INPUT GUIDE].
- 4) Press ◀▶ to switch the item.
 - The items will switch each time you press the button.

[ON]	Displays the input guide.
[OFF]	Hides the input guide.

Setting [WARNING MESSAGE]

Set the display/hide of the warning message.

- 1) Press ▲▼ to select [ON-SCREEN DISPLAY].
- 2) Press the <ENTER> button.
 - The [ON-SCREEN DISPLAY] screen is displayed.
- 3) Press ▲▼ to select [WARNING MESSAGE].
- 4) Press ◀▶ to switch the item.
 - The items will switch each time you press the button.

[ON]	Displays the warning message.
[OFF]	Hides the warning message.

[BACK COLOR]

Set the display of the projected screen when there is no signal input.

- 1) Press ▲▼ to select [BACK COLOR].
- 2) Press ◀▶ to switch the item.
 - The items will switch each time you press the button.

[BLUE]	Displays the entire projection area in blue.
[BLACK]	Displays the entire projection area in black.
[DEFAULT LOGO]	Displays the Panasonic logo.
[USER LOGO]	Displays the image registered by the user.

Note

- To create/register the [USER LOGO] image, use “Logo Transfer Software” included in the supplied CD-ROM.

[STARTUP LOGO]

Set the logo display when the power is turned on.

1) Press ▲▼ to select [STARTUP LOGO].

2) Press ◀▶ to switch the item.

- The items will switch each time you press the button.

[DEFAULT LOGO]	Displays the Panasonic logo.
[USER LOGO]	Displays the image registered by the user.
[NONE]	Disables the startup logo display.

Note

- The startup logo will disappear in approximately 15 seconds.
- To create/register the [USER LOGO] image, use "Logo Transfer Software" included in the supplied CD-ROM.

[UNIFORMITY]

Correct the brightness and color unevenness of the entire screen.

Setting each color

1) Press ▲▼ to select [UNIFORMITY].

2) Press the <ENTER> button.

- The [UNIFORMITY] screen is displayed.

3) Press ▲▼ to select [WHITE], [RED], [GREEN], or [BLUE].

4) Press ◀▶ to switch.

Parameter	Operation	Adjustment	Range of adjustment
[VERTICAL]	Press the ▶ button.	Deepens upper colors.	-127 - 127
	Press the ◀ button.	Deepens lower colors.	
[HORIZONTAL]	Press the ▶ button.	Deepens colors on the left.	
	Press the ◀ button.	Deepens colors on the right.	

Setting [PC CORRECTION]

To use the [PC CORRECTION] function, the optional Upgrade Kit (Model No.: ET-UK20) is required. To purchase the product, consult your dealer.

1) Press ▲▼ to select [UNIFORMITY].

2) Press the <ENTER> button.

- The [UNIFORMITY] screen is displayed.

3) Press ▲▼ to select [PC CORRECTION].

4) Press ◀▶ to switch the item.

[OFF]	Does not use a computer to correct.
[ON]*1	Use a computer to correct the brightness and color unevenness of the entire screen.

*1 Advanced skills are necessary to use computer controls to correct. Consult your dealer.

Note

- [UNIFORMITY] can be set for each [LAMP SELECT] setting.
- The [UNIFORMITY] settings are not reset to the factory default when [INITIALIZE] is executed.

[SHUTTER SETTING]

Set image fade-in and fade-out at opening and closing of the shutter. Set automatic opening and closing of the shutter when power is turned on.

Setting [FADE-IN] or [FADE-OUT]

- 1) Press ▲▼ to select [SHUTTER SETTING].
- 2) Press the <ENTER> button.
 - The [SHUTTER SETTING] screen is displayed.
- 3) Press ▲▼ to select [FADE-IN] or [FADE-OUT].
- 4) Press ◀▶ to switch the item.

Item		Adjustment
[FADE-IN] [FADE-OUT]	[OFF]	Does not set fade-in or fade-out.
	[0.5 s] - [10.0 s]	Allows you to set the fade-in or fade-out time. Select an item from [0.5 s] to [4.0 s], [5.0 s], [7.0 s], and [10.0 s]. [0.5 s] - [4.0 s] can be selected in increments of 0.5.

Note

- Press the <SHUTTER> button on the remote control or the control panel during fade-in or fade-out to cancel the fade operation.

Setting [STARTUP]

- 1) Press ▲▼ to select [SHUTTER SETTING].
- 2) Press the <ENTER> button.
 - The [SHUTTER SETTING] screen is displayed.
- 3) Press ▲▼ to select [STARTUP].
- 4) Press ◀▶ to switch the item.

[OPEN]	Projection begins with the shutter open when the power is turned on.
[CLOSE]	Projection begins with the shutter close when the power is turned on.

[FREEZE]

Pause the projected image temporarily regardless of the playback of the external device.

- 1) Press ▲▼ to select [FREEZE].
- 2) Press the <ENTER> button.
 - Press the <MENU> button to release.

Note

- [FREEZE] is displayed on the screen when video is paused.

[WAVEFORM MONITOR]

Use the input signals from a connected external device to display in a waveform. Check whether video output (luminance) signal level is within the recommended range for the projector and adjust.

- 1) Press ▲▼ to select [WAVEFORM MONITOR].
- 2) Press ◀▶ to switch the item.

[OFF]	Does not display the waveform monitor.
[ON]	Displays the waveform monitor.

- 3) Press the <MENU> button two times to clear.
- 4) Press ▲▼ to select any horizontal line.

5) Press the <ENTER> button to switch the Select line to either luminance, red, green, or blue.

- Line selection items switch each time the <ENTER> is pressed only when the waveform monitor is displayed.

“Select line (luminance)”	Displayed in white waveform.
“Select line (red)”	Displayed in red waveform.
“Select line (green)”	Displayed in green waveform.
“Select line (blue)”	Displayed in blue waveform.

Note

- Setting is also available from [FUNCTION BUTTON] (➔ page 121).
- Waveform monitor cannot be displayed in [P IN P].
- The waveform monitor turns off when [P IN P] is executed during waveform monitoring.
- The waveform monitor is not displayed when on-screen display is hidden (off).
- To display the waveform monitor in 3D images, use [3D WAVEFORM MONITOR]. (Only for PT-DZ13KE, PT-DS12KE, PT-DW11KE)

Adjusting the waveform

Project the luminance adjustment signal of a commercial test disk (0 % (0 IRE or 7.5 IRE) – 100 % (100 IRE)) and adjust.

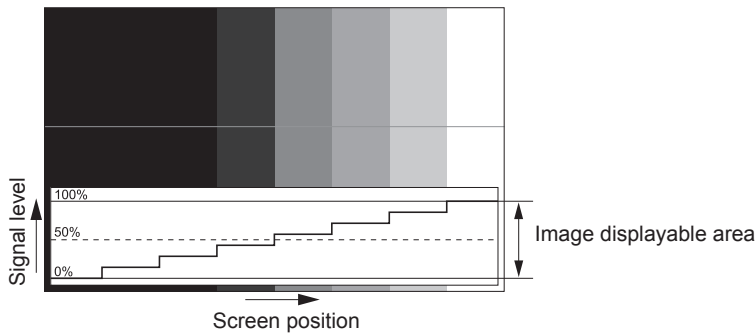

1) Select “Select line (luminance)” on the waveform monitor.

2) Adjust black level.

- Use [BRIGHTNESS] in the on-screen menu [PICTURE] to adjust the black level 0 % of the video signal to the 0 % position of the waveform monitor.

3) Adjust white level.

- Use [CONTRAST] in the on-screen menu [PICTURE] to adjust the white level 100 % of the video signal to the 100 % position of the waveform monitor.

Adjusting red, green, and blue

1) Set [COLOR TEMPERATURE] to [USER1] or [USER2] (➔ page 72).

2) Select “Select line (red)” on the waveform monitor.

3) Adjust dark red areas.

- Use [RED] in [WHITE BALANCE LOW] to adjust the black level 0 % of the video signal to the 0 % position of the waveform monitor.

4) Adjust bright red areas.

- Use [RED] in [WHITE BALANCE HIGH] to adjust the white level 100 % of the video signal to the 100 % position of the waveform monitor.

5) Use the procedure for [RED] to adjust [GREEN] and [BLUE].

Note

- Before adjusting the black level for DVI-D signals, HDMI signals, and SDI signals, confirm that the [SIGNAL LEVEL] setting is correct.

[CUT OFF]

Each red, green, and blue color component can be removed.

- 1) Press ▲▼ to select [CUT OFF].
- 2) Press the <ENTER> button.
 - The [CUT OFF] screen is displayed.
- 3) Press ▲▼ to select [RED], [GREEN], or [BLUE].
- 4) Press ◀▶ to switch the item.

[OFF]	Disables cutoff.
[ON]	Enables cutoff.

Note

- When input is switched or a signal is switched, the cutoff setting returns to its original setting (off).

[PROJECTOR SETUP] menu

On the menu screen, select [PROJECTOR SETUP] from the main menu, and select an item from the sub-menu.

Refer to “Navigating through the menu” (➔ page 65) for the operation of the menu screen.

- After selecting the item, press ▲▼◀▶ to set.

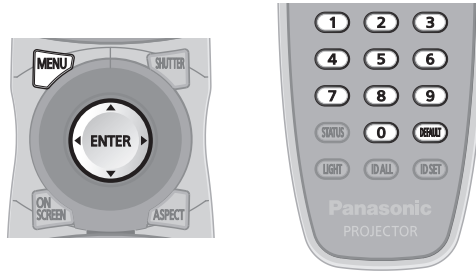

[PROJECTOR ID]

The projector has an ID number setting function that can be used when multiple projectors are used side by side to enable simultaneous control or individual control via a single remote control.

1) Press ▲▼ to select [PROJECTOR ID].

2) Press ◀▶ to switch the item.

- The items will switch each time you press the button.

[ALL]	Select when controlling projectors without specifying an ID number.
[1] - [64]	Select when specifying an ID number to control individual projector.

Note

- To specify an ID number for individual control, the ID number of a remote control must match the ID number of the projector.
- When the ID number is set to [ALL], the projector will operate regardless of the ID number specified during remote control or computer control.
If multiple projectors are set up side by side with IDs set to [ALL], they cannot be controlled separately from the projectors with other ID numbers.
- Refer to “Setting the remote control ID numbers” (➔ page 28) for how to set the ID number on the remote control.

[PROJECTION METHOD]

Set the projection method in accordance with the installation status of the projector.

Change the projection method if the screen display is upside down or inverted.

1) Press ▲▼ to select [PROJECTION METHOD].

2) Press the <ENTER> button.

- The [PROJECTION METHOD] screen is displayed.

3) Press ▲▼ to select the projection method.

[FRONT/FLOOR]	When installing the projector on the desk, etc., in front of the screen
[FRONT/CEILING]	When installing the projector in front of the screen using the Ceiling Mount Bracket for Projectors (optional)
[REAR/FLOOR]	When installing the projector on the desk, etc., behind the screen (with a translucent screen)
[REAR/CEILING]	When installing the projector behind the screen (with a translucent screen) using the Ceiling Mount Bracket for Projectors (optional)

4) Press the <ENTER> button.

5) When the confirmation screen is displayed, press ◀▶ to select [OK], and press the <ENTER> button.

Attention

- When the [PROJECTION METHOD] setting is changed, confirm that [COOLING CONDITION] (➔ page 109) is set correctly.

[COOLING CONDITION]

Change the fan control depending on the direction of projection.

Set [COOLING CONDITION] according to the projection direction, but set it to [AUTO] normally. Using the projector with incorrect setting may shorten the life of the lamp.

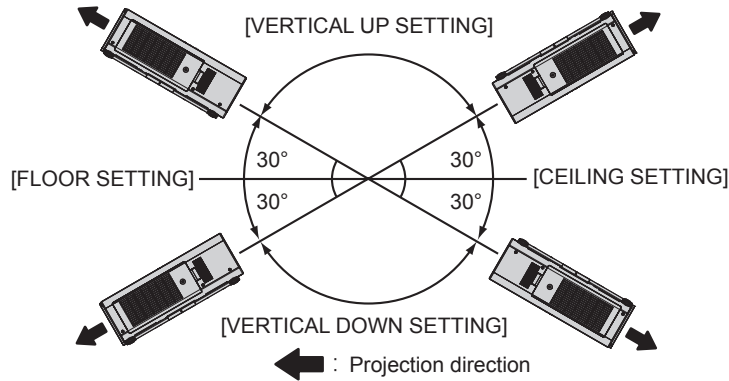

- 1) Press ▲▼ to select [COOLING CONDITION].
- 2) Press the <ENTER> button.
 - The [COOLING CONDITION] screen is displayed.
- 3) Press ▲▼ to select a cooling condition.
 - When [AUTO] is selected, the cooling conditions of [FLOOR SETTING], [CEILING SETTING], [VERTICAL UP SETTING], and [VERTICAL DOWN SETTING] are set automatically.
 - You can check the setting from [COOLING CONDITION] on the [STATUS] screen.
- 4) Press the <ENTER> button.
- 5) When the confirmation screen is displayed, press ◀▶ to select [OK], and press the <ENTER> button.

Note

- This item cannot be set when using the optional Replacement lamp unit (for portrait mode) (Model No.: ET-LAD320P (1 pc), ET-LAD320PW (2 pcs)). (Setting is fixed to [PORTRAIT SETTING].)

[HIGH ALTITUDE MODE]

Set to [ON] when using the projector at high altitudes between 1 400 m (4 593') or higher and lower than 2 700 m (8 858') above sea level.

- 1) Press ▲▼ to select [HIGH ALTITUDE MODE].
- 2) Press ◀▶ to switch the item.

[OFF]	When using at a location lower than 1 400 m (4 593') above sea level
[ON]	When using at high altitudes (1 400 m (4 593') or higher and lower than 2 700 m (8 858') above sea level)

- 3) When the confirmation screen is displayed, press ◀▶ to select [OK], and press the <ENTER> button.

Note

- The speed of the fan increases and the operation sound becomes louder when set to [ON].
- This item cannot be set when using the optional Smoke cut filter (Model No.: ET-SFD320). (Setting is fixed to [OFF].) Use it at elevations lower than 1 400 m (4 593') above sea level.

[LAMP SELECT]

Select the lamp to be turned on from the two built-in luminous lamps according to the use conditions or purposes.

- 1) Press ▲▼ to select [LAMP SELECT].
- 2) Press ◀▶ to switch the item.

[DUAL]	Two lamps will light.
[SINGLE]	One lamp will light. (The lamp with shorter runtime will automatically light.)
[LAMP1]	Lamp 1 will light.
[LAMP2]	Lamp 2 will light.

3) Press the <ENTER> button.

Note

- For a certain time after [LAMP SELECT] is switched, [LAMP SELECT] cannot be switched again, because the speed of the lamp replacement cycle will increase. Repeatedly switching [LAMP SELECT] in a short time will also increase the speed of the lamp replacement cycle.
- The colors of the items indicate the status.

Green	Current setting
Yellow	Current setting (when there is a lamp that cannot turn on or failed to turn on)
Red	Lamp that has failed to turn on
White	Any other status

- When a lamp cannot turn on or the runtime exceeds 2 500 hours^{*1*}, the lamp is turned off and the other lamp is turned on. The projector enters standby mode when the runtime of both lamps exceeds 2 500 hours^{*1*}.

*1 500 hours when using the optional Replacement lamp unit (for portrait mode) (Model No.: ET-LAD320P (1 pc), ET-LAD320PW (2 pcs)).

*2 3 500 hours for PT-DZ10KE.

- Ensure that lamp units not to be turned on are also installed.
- More lamps than the specified number of lamps light temporarily to prevent decreased illuminance when a lamp is switched.

[LAMP RELAY]

Switch the lamp to be turned on automatically by specifying the day of the week and time.

The degradation of the lamp due to continuous usage can be reduced by automatically switching the lamp to be turned on when using the projector continuously for a week or more.

1) Press ▲▼ to select [LAMP RELAY].

2) Press ◀▶ to switch the item.

[OFF]	Disables lamp relay.
[24H]	Switches the lamp daily.
[1WEEK]	Switches the lamp weekly.

- When [24H] or [1WEEK] is selected, proceed to Step 3).

3) Press ▲▼ to select [TIME].

4) Press the <ENTER> button.

- Enters adjustment mode (the display is blinking).

5) Press ◀▶ to select “hour” or “minute”, and press ▲▼ or the number (<0> - <9>) buttons to set a time.

- Selecting “hour” allows setting of only the hour in increments of one hour, and selecting “minute” allows setting of only the minute in increments of one minute between 00 and 59.

6) Press the <ENTER> button.

- The adjusted time is established.
- When [1WEEK] is selected in Step 2), proceed to Step 7).

7) Press ▲▼ to select [DAY OF THE WEEK].

8) Press ◀▶ to switch the item.

[SUNDAY]	Switches the lamp automatically on the set day of the week.
[MONDAY]	
[TUESDAY]	
[WEDNESDAY]	
[THURSDAY]	
[FRIDAY]	
[SATURDAY]	

Note

- The [LAMP RELAY] function is enabled when [SINGLE] or [DUAL] is selected in [LAMP SELECT].
- When [DUAL] is selected in [LAMP SELECT], only one lamp will light for four hours from the specified time.
- The operating time will be the local time. (➔ page 121)

[LAMP POWER]

Switch the brightness of the lamp according to the operating environment of the projector or the purpose.

- 1) Press ▲▼ to select [LAMP POWER].
- 2) Press ◀▶ to switch the item.

[HIGH]*1	Select when high luminance is required.
[MIDDLE]*1	Select when using the projector with slightly reduced luminance compared to [HIGH].
[NORMAL]*2	Select when high luminance is required.
[ECO]	Select when high luminance is not required.

*1 Only for PT-DZ13KE, PT-DS12KE, PT-DW11KE

*2 Only for PT-DZ10KE

Note

- [HIGH] cannot be selected when the optional Replacement lamp unit (for portrait mode) (Model No.: ET-LAD320P (1 pc), ET-LAD320PW (2 pcs)) is used. Even when [HIGH] is selected while the normal lamp unit is used, the setting is switched to [MIDDLE] automatically if the optional Replacement lamp unit (for portrait mode) is used.
- You can reduce power consumption and operation noise, and extend the life of the lamps by setting to [MIDDLE] rather than [HIGH], or by setting to [ECO] rather than [MIDDLE] or [NORMAL].

[BRIGHTNESS CONTROL]

The projector is equipped with a luminance sensor to measure brightness and functions to correct screen brightness resulting from changes in lamp brightness.

Use the projector when using multiple projectors to display on multiple screens to reduce changes in overall brightness of the multiple screens due to lamp degradation and suppress variation in brightness to preserve uniformity.

Setting [BRIGHTNESS CONTROL GAIN]

Adjust the brightness when displaying multiple screens using multiple projectors.

- 1) Press ▲▼ to select [BRIGHTNESS CONTROL].
- 2) Press the <ENTER> button.
 - The [BRIGHTNESS CONTROL] screen is displayed.
- 3) Press ▲▼ to select [BRIGHTNESS CONTROL GAIN].
- 4) Press ◀▶ to adjust.

Operation	Adjustment		Range of adjustment
	Brightness	Maximum amount of brightness correction	
Press the ▶ button.	The screen becomes brighter.	The maximum amount of correction is reduced.	20 % - 100 %
Press the ◀ button.	The screen becomes darker.	The maximum amount of correction is increased.	

Note

- When using only one projector, the value obtained by subtracting the value of the [BRIGHTNESS CONTROL GAIN] from 100 % is the maximum amount of brightness correction. Brightness cannot be corrected through brightness control since the maximum amount of correction becomes 0 % when [BRIGHTNESS CONTROL GAIN] is at 100 %.
- Luminance will be unsteady for eight minutes after a lamp is turned on. Make adjustments at least 8 minutes after starting projection.
- The result of [BRIGHTNESS CONTROL GAIN] adjustments is reflected on all image signals, internal test patterns, and on-screen menus.
- The [BRIGHTNESS CONTROL GAIN] setting is enabled even if [BRIGHTNESS CONTROL SETUP] is [OFF].

Setting [BRIGHTNESS CONTROL SETUP]

Set brightness control operation.

- 1) Press ▲▼ to select [BRIGHTNESS CONTROL].
- 2) Press the <ENTER> button.
 - The [BRIGHTNESS CONTROL] screen is displayed.
- 3) Press ▲▼ to select [BRIGHTNESS CONTROL SETUP].

- 4) Press the <ENTER> button.
 - The [BRIGHTNESS CONTROL SETUP] screen is displayed.
- 5) Press ▲▼ to select [MODE].
- 6) Press ◀▶ to switch the item.
 - The items will switch each time you press the button.

[OFF]	Does not correct the brightness of the screen by the brightness sensor.
[AUTO]	Corrects the brightness of the screen by the brightness sensor. Automatically corrects screen brightness when lamp brightness changes.
[PC]	Synchronizes nine or more projectors through a computer using the dedicated software "Multi Projector Monitoring & Control Software"*1.

*1 "Multi Projector Monitoring & Control Software" is included in the supplied CD-ROM.
 • When [AUTO] is selected, proceed to Step 7).

- 7) Press ▲▼ to select [LINK].
- 8) Press ◀▶ to switch the item.
 - The items will switch each time you press the button.

[OFF]	Performs corrections by the brightness sensor in one projector without synchronizing with the other projectors. The period, in which the constant brightness kept by the small value of [BRIGHTNESS CONTROL GAIN], is prolonged.
[GROUP A] [GROUP B] [GROUP C] [GROUP D]	Synchronizes corrections in multiple projectors by the brightness sensor. You can set up to four groups (A to D) within the same subnet by using the network function. You can also register and synchronize up to eight projectors in one group.

- 9) Press ▲▼ to select [CALIBRATION TIME].
- 10) Press the <ENTER> button.
 - Enters adjustment mode (the display is blinking).
- 11) Press ◀▶ to select "hour" or "minute", and press ▲▼ or the number (<0> - <9>) buttons to set a time.
 - Selecting "hour" allows setting of only the hour in increments of one hour, and selecting "minute" allows setting of only the minute in increments of one minute between 00 and 59.
 - If you do not specify the time, select [OFF] between 23 and 00 o'clock or between 59 and 00 minutes.
- 12) Press the <ENTER> button.
 - [CALIBRATION TIME] is set.
 - Brightness is measured at the specified time. Dynamic iris is fixed to open during measurement.
- 13) Press ▲▼ to select [CALIBRATION MESSAGE].
- 14) Press ◀▶ to switch the item.
 - The items will switch each time you press the button.

[ON]	Messages are displayed during calibration.
[OFF]	Messages are not displayed during calibration.

- 15) Press ▲▼ to select [APPLY].
- 16) Press the <ENTER> button.
 - The set [MODE] and [LINK] are enabled, and LAMP RELAY screen alert is displayed when the [LAMP RELAY] setting is [OFF]. When [CALIBRATION MESSAGE] is set to [ON], a calibration running message is displayed which will automatically disappear 30 seconds after calibration completes.
 - If the <ENTER> button is pressed with [MODE] in [BRIGHTNESS CONTROL SETUP] set to other than [OFF], the brightness of the lamp at the time the button was pressed is recorded as the standard brightness.
 - If the <ENTER> button is pressed when [LINK] is set from [GROUP A] to [GROUP D], the group name is displayed on the screens of projectors that have been set in the same group.



Note

- When [MODE] in [BRIGHTNESS CONTROL SETUP] is set to [AUTO] or [PC], keep the shutter open for at least two minutes to perform the brightness sensor calibration after completed the [BRIGHTNESS CONTROL SETUP] setting.
- If the shutter is closed within approx. 10 minutes after the lamp has turned on while [MODE] in [BRIGHTNESS CONTROL SETUP] is set to [AUTO] or [PC], brightness cannot be measured. Therefore, brightness may be corrected approx. two minutes after the shutter opens.
- When [MODE] in [BRIGHTNESS CONTROL SETUP] is set to [AUTO] or [PC], the lamp brightness is automatically measured eight minutes after the lamp is turned on, and correction is performed so that the screen brightness will be the same as the standard brightness when the brightness control is adjusted. Lamp brightness cannot be measured during the eight minutes after it is turned on because it is not steady.
- If a lamp turns off or lamp relay is performed while [MODE] in [BRIGHTNESS CONTROL SETUP] is set to [AUTO] and [LAMP SELECT] is set to [DUAL], brightness is corrected to the extent possible one minute later.
- When [MODE] in [BRIGHTNESS CONTROL SETUP] is set to [AUTO] and [LINK] is set to [OFF], brightness will be corrected until it reaches the maximum amount of correction.
- The variation in brightness may increase due to dust accumulating on the lens, screen, or inside the projector, depending on the installation environment of the projector.
- Adjust brightness control again when lamp degradation causes increased variation in brightness or a lamp is replaced.
- For continued use longer than 24 hours, set the [BRIGHTNESS CONTROL SETUP] to [CALIBRATION TIME], or set [LAMP RELAY] (► page 110). If it is not set, correction will not be performed automatically.
- Brightness control and iris operate simultaneously, but the iris is fully open and does not operate while a brightness measurement is performed.
- The [CALIBRATION TIME] setting will be reflected at the time when you enter the time.
- The [CALIBRATION MESSAGE] setting will be reflected at the time when items are switched using ◀▶.

Displaying [BRIGHTNESS CONTROL STATUS]

Display the brightness control status.

- 1) Press ▲▼ to select [BRIGHTNESS CONTROL].
- 2) Press the <ENTER> button.
 - The [BRIGHTNESS CONTROL] screen is displayed.
- 3) Press ▲▼ to select [BRIGHTNESS CONTROL STATUS].
- 4) Press the <ENTER> button.
 - The [BRIGHTNESS CONTROL STATUS] screen is displayed.

[BRIGHTNESS CONTROL STATUS] screen display example

When [MODE] of [BRIGHTNESS CONTROL SETUP] is set to [OFF]
The screen shows the status that the brightness control is disabled.

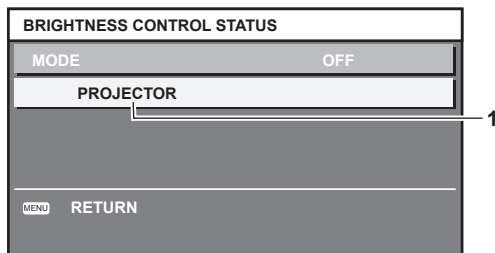

When [MODE] of [BRIGHTNESS CONTROL SETUP] is set to [AUTO] and [LINK] is set to [OFF]
The screen shows the status of the brightness control in one projector

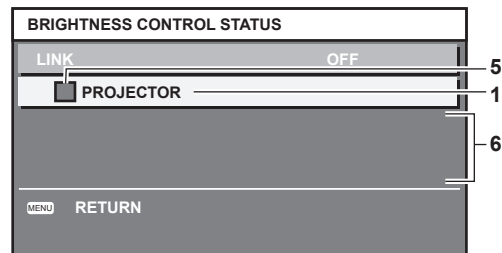

When [MODE] of [BRIGHTNESS CONTROL SETUP] is set to [AUTO] and [LINK] is set from [GROUP A] to [GROUP D]

The screen shows the status of the brightness control of synchronized projectors (up to eight units), including the projector being controlled through the on-screen menu.

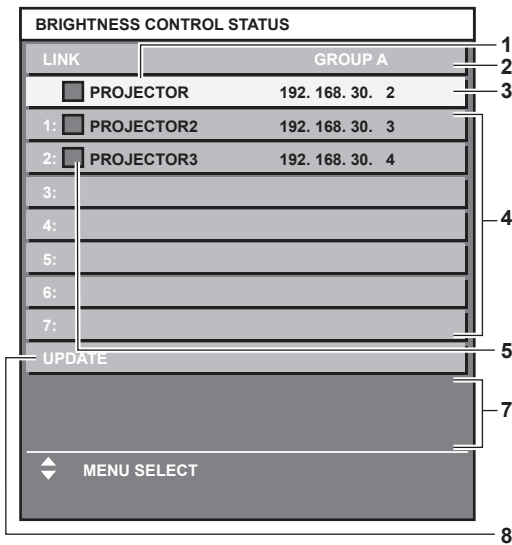

When [MODE] of [BRIGHTNESS CONTROL SETUP] is set to [PC]

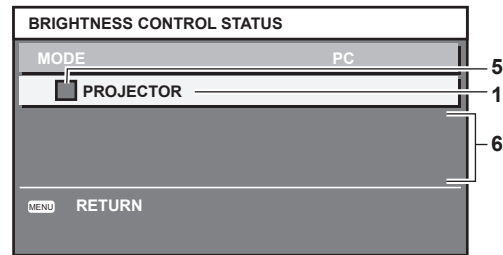

- 1 Display the name of the projector.
- 2 Display the synchronized group.
- 3 Display the IP address of the projector.
- 4 Display the names and IP addresses of projectors in same group detected over the network.
- 5 Display the status by color.
Green: There is an allowance for brightness correction.
Yellow: There is little allowance for brightness correction.
Red: There is a brightness control error.
- 6 Display error detailed messages.
- 7 Display error messages.
When the message [Failed to apply BRIGHTNESS CONTROL to some projectors.] appears, it means that synchronization with the projector displayed in red has failed.
Press ▲▼ to select the projector displayed in red, and press the <ENTER> button to display the error details.
- 8 Update to the latest status information.

■ Error details

Error message	Measures to take
[Exceed maximum number of projectors.]	<ul style="list-style-type: none"> • Limit the number of projectors in one group to eight. • When synchronizing nine or more projectors, use the dedicated software "Multi Projector Monitoring & Control Software"^{*1} through a computer.
[Please check the COMMAND CONTROL setting.]	<ul style="list-style-type: none"> • Set [NETWORK CONTROL] → [COMMAND CONTROL] to [ON] for the projector in error. • Set [NETWORK CONTROL] → [COMMAND PORT] of all projectors to be linked to the same value.
[Please check the USER NAME and PASSWORD in the COMMAND CONTROL setting.]	<ul style="list-style-type: none"> • Assign the same [User name] and [Password] strings that have web control administrator rights to all projectors to be linked.
[Cannot apply BRIGHTNESS CONTROL. Please check projector status.]	<ul style="list-style-type: none"> • The projector is in standby. Switch on the power.
[Brightness Sensor Error]	<ul style="list-style-type: none"> • There is a problem with the brightness sensor. If problems persist even after switching on the power, consult your dealer.

*1 "Multi Projector Monitoring & Control Software" is included in the supplied CD-ROM.

Note

- If the synchronized projectors are not displayed in the list, check the following:
 - Are there devices with the same IP address on the network?
 - Are the LAN cables connected correctly? (➡ page 136)
 - Are the subnets of the projectors the same?
 - Are the same [LINK] settings applied to a group?
- Refer to [NETWORK SETUP] (➡ page 135) or "[Network config] page" (➡ page 144) on how to change the projector name.

Brightness control adjustment procedure example

The steps exemplify an adjustment to link the brightness of eight projectors connected in a network.

- 1) **Connect all projectors to the hub using LAN cables. (➡ page 136)**
- 2) **Switch on all projectors and start projection.**
- 3) **Set [LAMP SELECT] to either [DUAL] or [SINGLE] for all projectors.**
- 4) **Set [MODE] of [BRIGHTNESS CONTROL SETUP] to [OFF], and select [APPLY], and then press the <ENTER> button.**
- 5) **Set [SUBNET MASK] and [IP ADDRESS] in each projector.**
 - To be able to communicate over the network, set the same value in [SUBNET MASK] for all projectors and set a different value in [IP ADDRESS] for each projector.
- 6) **Wait for at least eight minutes after starting projection until the lamp brightness becomes steady.**
- 7) **Set all items in the [PICTURE] menu of all projectors to the same values.**
- 8) **Adjust [COLOR MATCHING] to match colors.**
- 9) **Display the internal test pattern “All white” in all projectors.**
- 10) **Set [BRIGHTNESS CONTROL GAIN] to 100 % in all projectors.**
- 11) **Set [BRIGHTNESS CONTROL GAIN] to 90 % in the projector with the least brightness.**
- 12) **Adjust [BRIGHTNESS CONTROL GAIN] in each projector.**
 - Adjust [BRIGHTNESS CONTROL GAIN] of all the other projectors so that the brightness is matched to the projector of which [BRIGHTNESS CONTROL GAIN] is set to 90 %.
- 13) **Set [MODE] of [BRIGHTNESS CONTROL SETUP] to [AUTO], and [LINK] to [GROUP A] in all projectors.**
- 14) **Select [APPLY] of [BRIGHTNESS CONTROL SETUP] and press the <ENTER> button in all projectors.**
 - Brightness control starts.

Note

- Brightness is automatically corrected each time the lamp blinks when the power is switched on or off.
- Adjust brightness control again when variation in brightness has increased or a lamp is replaced.

[STANDBY MODE]

Set the power consumption during the standby.

- 1) **Press ▲▼ to select [STANDBY MODE].**
- 2) **Press ◀▶ to switch the item.**
 - The items will switch each time you press the button.

[NORMAL]	Use this setting to use the network function during standby.
[ECO]	Use this setting to reduce power consumption during standby.

Note

- When set to [ECO], network functions, <SERIAL OUT> terminal, and some RS-232C commands are not available during standby.
- When set to [ECO], it may take approx. 10 seconds longer before the projector starts projecting after the power is turned on, compared with when [NORMAL] is set.

[SCHEDULE]

Set the command execution schedule for each day of the week.

Enabling/disabling the schedule function

- 1) Press ▲▼ to select [SCHEDULE].
- 2) Press ◀▶ to switch the item.
 - The items will switch each time you press the button.

[OFF]	Disables the schedule function.
[ON]	Enables the schedule function. Refer to “How to assign a program” (➔ page 116) or “How to set a program” (➔ page 116) for how to set the schedule.

Note

- When [SCHEDULE] is set to [ON], the [STANDBY MODE] setting is forcibly switched to [NORMAL], and the setting cannot be changed. Even if [SCHEDULE] is then set to [OFF] when in this state, the setting of [STANDBY MODE] remains at [NORMAL].

How to assign a program

- 1) Press ▲▼ to select [SCHEDULE].
- 2) Press ◀▶ to select [ON], and press the <ENTER> button.
 - The [SCHEDULE] screen is displayed.
- 3) Select and assign program to each day of week.
 - Press ▲▼ to select the day of week, and press ◀▶ to select a program number.
 - You can set the program from No.1 to No.7. “- -” indicates that the program number has not been set.

How to set a program

Set up to 16 commands to each program.

- 1) Press ▲▼ to select [SCHEDULE].
- 2) Press ◀▶ to select [ON], and press the <ENTER> button.
 - The [SCHEDULE] screen is displayed.
- 3) Press ▲▼ to select [PROGRAM EDIT].
- 4) Press ◀▶ to select a program number, and press the <ENTER> button.
- 5) Press ▲▼ to select a command number, and press the <ENTER> button.
 - You can change the page using ◀▶.
- 6) Press ▲▼◀▶ to select [TIME], and press the <ENTER> button.
- 7) Press ◀▶ to select “hour” or “minute”, and press ▲▼ or the number (<0> - <9>) buttons to set a time, and then press the <ENTER> button.
- 8) Press ▲▼◀▶ to select [COMMAND].
- 9) Press ◀▶ to switch the item.
 - The items will switch each time you press the button.
 - For the detailed settings of [COMMAND], the details set in Step 11) are displayed.

[COMMAND]	Detailed settings of [COMMAND]	Description
[POWER ON]	—	Switches on the projector.
[STANDBY]	—	Enters standby.
[SHUTTER]	[OPEN]	Opens the shutter.
	[CLOSE]	Closes the shutter.

[COMMAND]	Detailed settings of [COMMAND]	Description
[INPUT]	[VIDEO]	Switches the input to VIDEO.
	[RGB1]	Switches the input to RGB1.
	[RGB2]	Switches the input to RGB2.
	[DVI-D]	Switches the input to DVI-D.
	[HDMI]	Switches the input to HDMI.
	[SDI1]*1	(PT-DZ13KE, PT-DS12KE) Switches the input to SDI1. (PT-DZ10KE) Switches the input to SDI.
	[SDI2]*2	Switches the input to SDI2.
[LAMP SELECT]	[DUAL]	Turns on two lamps.
	[SINGLE]	Turns on one lamp. (The lamp with shorter runtime will automatically light.)
[LAMP POWER]	[HIGH]*3	Sets the lamp brightness to high luminance.
	[MIDDLE]*4	Sets the lamp brightness to slightly lower luminance compared to [HIGH].
	[NORMAL]*5	Sets the lamp brightness to high luminance.
	[ECO]	Sets the lamp brightness to low luminance.
[P IN P]	[OFF]	P IN P function is not used.
	[USER1]	Lays out the sub-screen with the settings of [USER1].
	[USER2]	Lays out the sub-screen with the settings of [USER2].
	[USER3]	Lays out the sub-screen with the settings of [USER3].

*1 Only for PT-DZ13KE, PT-DS12KE, PT-DZ10KE

*2 Only for PT-DZ13KE, PT-DS12KE

*3 Only for PT-DZ13KE, PT-DS12KE, PT-DW11KE. Even when the command for [HIGH] is set, it is not reflected at the execution, if the optional Replacement lamp unit (for portrait mode) (Model No.: ET-LAD320P (1 pc), ET-LAD320PW (2 pcs)) is used.

*4 Only for PT-DZ13KE, PT-DS12KE, PT-DW11KE

*5 Only for PT-DZ10KE

10) Press the <ENTER> button.

- The [COMMAND] detailed screen is displayed.

11) Press ▲▼ to select a [COMMAND].

- For [COMMAND] which requires detailed settings, the items of the detailed settings will switch each time you press ◀▶.

12) Press the <ENTER> button.

- The command is fixed and ● is displayed at the left of the selected command.
- After the command is fixed, press the <MENU> button to close the detailed setting screen.

13) Press ▲▼◀▶ to select [STORE], and press the <ENTER> button.

Note

- If you attempt to register the setting that would make the lamp turn on for a short time, an error message will be displayed on the screen. Set the time and command again.
- To delete a command already set, press the <DEFAULT> button on the Step 5) screen, or select [DELETE] on the Step 6) screen and press the <ENTER> button.
- If multiple commands have been set for the same time, they are executed in chronological order starting from the smallest command number.
- The operating time will be the local time. (➡ page 121)
- If an operation is executed with the remote control or control panel of the projector or with a control command before the command set in [SCHEDULE] is executed, the command set with this function may not be executed.

[STARTUP INPUT SELECT]

Set the input when the projector is switched on to start projection.

1) Press ▲▼ to select [STARTUP INPUT SELECT].

2) Press ◀▶ to switch the item.

- The items will switch each time you press the button.

[LAST USED]	Keeps the input selected last.
[VIDEO]	Sets the input to VIDEO.
[RGB1]	Sets the input to RGB1.

[RGB2]	Sets the input to RGB2.
[DVI-D]	Sets the input to DVI-D.
[HDMI]	Sets the input to HDMI.
[SDI1]*1/[SDI]*2	Sets the input to SDI/SDI1.
[SDI2]*1	Sets the input to SDI2.

*1 Only for PT-DZ13KE, PT-DS12KE

*2 Only for PT-DZ10KE

[RS-232C]

Set the communication conditions of the <SERIAL IN>/<SERIAL OUT> terminal.

Setting the communication condition of the <SERIAL IN> terminal

- 1) Press ▲▼ to select [RS-232C].
- 2) Press the <ENTER> button.
 - The [RS-232C] screen is displayed.
- 3) Press ▲▼ to select [(IN) BAUDRATE].
- 4) Press ◀▶ to switch the item.
 - The items will switch each time you press the button.

[9600]	Select the proper speed.
[19200]	
[38400]	

- 5) Press ▲▼ to select [(IN) PARITY].
- 6) Press ◀▶ to switch the item.
 - The items will switch each time you press the button.

[NONE]	Select the parity condition.
[EVEN]	
[ODD]	

Setting the communication condition of the <SERIAL OUT> terminal

- 1) Press ▲▼ to select [RS-232C].
- 2) Press the <ENTER> button.
 - The [RS-232C] screen is displayed.
- 3) Press ▲▼ to select [(OUT) BAUDRATE].
- 4) Press ◀▶ to switch the item.

[9600]	Select the proper speed.
[19200]	
[38400]	

- 5) Press ▲▼ to select [(OUT) PARITY].
- 6) Press ◀▶ to switch the item.
 - The items will switch each time you press the button.

[NONE]	Select the parity condition.
[EVEN]	
[ODD]	

Setting the response

- 1) Press ▲▼ to select [RS-232C].
- 2) Press the <ENTER> button.
 - The [RS-232C] screen is displayed.
- 3) Press ▲▼ to select [RESPONSE(ID ALL)].
- 4) Press ◀▶ to switch the item.

[ON]	Returns the response when the ID setting is ALL.
[OFF]	Does not return the response when the ID setting is ALL.

- 5) Press ▲▼ to select [GROUP].
- 6) Press ◀▶ to switch the item.

[A] - [Z]	Controls multiple projectors simultaneously by sending the ID of RS-232C. You can set groups from [A] to [Z]. The projector responds when the ID of RS-232C matches the setting.
-----------	--

- 7) Press ▲▼ to select [RESPONSE(ID GROUP)].
- 8) Press ◀▶ to switch the item.

[ON]	Returns the response when the ID setting is GROUP.
[OFF]	Does not return the response when the ID setting is GROUP.

Note

- Refer to “<SERIAL IN>/<SERIAL OUT> terminal” (➔ page 171).

[STATUS]

Display the status of the projector.

- 1) Press ▲▼ to select [STATUS].
- 2) Press the <ENTER> button.
 - The [STATUS] screen is displayed.
- 3) Press ◀▶ to switch the pages.
 - The page will change each time you press the button.

[INPUT]	Displays the input terminal currently selected.	
[SIGNAL NAME]	Displays the input signal name.	
[SIGNAL FREQUENCY]	Displays the frequency of the input signal.	
[PROJECTOR RUNTIME]	Displays the operation times of the projector.	
[LAMP1]*1	Displays the runtime and status of Lamp 1.	
[LAMP2]*1	Displays the runtime and status of Lamp 2.	
[INTAKE AIR TEMP.]	Displays the status of the air intake temperature of the projector.	
[OPTICS MODULE TEMP.]	Displays the status of the internal temperature of the projector.	
[AROUND LAMP TEMP.]	Displays the status of the temperature around the lamps of the projector.	
[PROJECTOR TYPE]	Displays the type of the projector.	
[SERIAL NUMBER]	Displays the serial number of the projector.	
[LAMP UNIT MODEL NO.]	Displays the model no. of the lamp unit.	
[LAMP1 SERIAL NUMBER]	Displays the serial number of the lamp 1.	
[LAMP2 SERIAL NUMBER]	Displays the serial number of the lamp 2.	
[MAIN VERSION]	Displays the main version of the firmware of the projector.	
[SUB VERSION]	Displays the sub version of the firmware of the projector.	
[NETWORK VERSION]	Displays the firmware version of the projector.	
[UPGRADE(ET-UK20)]	Displays the activation status based on the Upgrade Kit.	
[ON COUNT]	[POWER ON TIMES]	Displays the number of times the power is turned on.
	[LAMP1 ON]	Displays the number of times the lamp is turned on.
	[LAMP2 ON]	

[LAMP1]	Displays runtime in detail.	
[LAMP2]	Displays runtime in detail.	
[NUMBER OF REGISTERED SIGNAL]	Displays the number of registered signals.	
[REMOTE2 STATUS]	Displays the control status of the REMOTE2.	
[AC VOLTAGE]	Displays the status of the AC voltage.	
[COOLING CONDITION]	Displays the set cooling conditions. When [AUTO] is set, automatically recognized result is displayed.	
[SIGNAL INFORMATION]	[MEMORY NO.]	Displays the memory number of the input signal.
	[INPUT]	Displays the input terminal currently selected.
	[SIGNAL NAME]	Displays the input signal name.
	[SIGNAL FREQUENCY]	Displays the frequency of the input signal.
	[SYNC.STATE]	Displays the synch polarity of the input signal.
	[V.SYNC WIDTH]	Displays the vertical sync signal pulse width of the input signal.
	[SCAN TYPE]	Displays the scan type of the input signal.
	[TOTAL DOTS]	Displays the total dot count of the input signal.
	[DISPLAY DOTS]	Displays the number of input signal display dots.
	[TOTAL LINES]	Displays the total line count of the input signal.
	[DISPLAY LINES]	Displays the number of input signal display lines.
	[SAMPLING]	Displays the sampling information of the input signal.
[SIGNAL LEVEL]	Displays the signal level of the input signal.	
[BIT DEPTH]	Displays the gradation of the input signal.	

*1 The lamp runtime to be displayed is real time. The following conversion is required to calculate the rough estimate for lamp replacement.

Model No.	Formula for lamp replacement time (rough estimate)
PT-DZ13KE PT-DS12KE PT-DW11KE	$(A \times 56 + B \times 40 + C \times 35) \div 56$ • A: Runtime when [LAMP POWER] is set to [HIGH] • B: Runtime when [LAMP POWER] is set to [MIDDLE] • C: Runtime when [LAMP POWER] is set to [ECO] The formula when the optional Replacement lamp unit (for portrait mode) is used is: $(B \times 2 + C) \div 2$
PT-DZ10KE	$(A \times 40 + B \times 35) \div 40$ • A: Runtime when [LAMP POWER] is set to [NORMAL] • B: Runtime when [LAMP POWER] is set to [ECO] The formula when the optional Replacement lamp unit (for portrait mode) is used is: $(A \times 2 + B) \div 2$

Note

- The content of status can be sent via E-mail by pressing the <ENTER> button while displaying the status.
- Some items in [SIGNAL INFORMATION] may be displayed and others not displayed, depending on the signal being input.
- If you attach a lamp unit used in a projector of a model different from the projector (PT-DZ13KE, PT-DS12KE, PT-DW11KE, PT-DZ10KE) to the projector, or when the lamp unit used in the projector to a projector of a different model, the "lighting time" and "runtime" displayed in [STATUS] may differ from the actual time.

[NO SIGNAL SHUT-OFF]

A function that automatically switches the power source of the projector to standby if there is no input signal for a certain period of time. The time before switching to standby can be set.

- 1) Press ▲▼ to select [NO SIGNAL SHUT-OFF].
- 2) Press ◀▶ to switch the item.
 - The items will switch each time you press the button.

[DISABLE]	Disables the No signal shut-off function.
[10MIN.] - [90MIN.]	Allows you to set in ten minutes intervals.

[REMOTE2 MODE]

You can set the <REMOTE 2 IN> terminal.

- 1) Press ▲▼ to select [REMOTE2 MODE].
- 2) Press ◀▶ to switch the item.
 - The items will switch each time you press the button.

[DEFAULT]	The pin assignment of the <REMOTE 2 IN> terminal is used by the factory default setting of the projector.
[USER]	Used to change the setting of the <REMOTE 2 IN> terminal.
[L6500 SERIES]	The setting of <REMOTE 2 IN> terminal is used for the L6500 series compatibility.

- When [USER] is selected, proceed to Step 3).

3) Press the <ENTER> button.

4) Press ▲▼ to select one from [PIN2] to [PIN8], and press ◀▶ to switch the setting.

[FUNCTION BUTTON]

Set the functions of the <FUNC> button on the remote control.

1) Press ▲▼ to select [FUNCTION BUTTON].

2) Press the <ENTER> button.

- The [FUNCTION BUTTON] screen is displayed.

3) Press ▲▼ to select a function.

[DISABLE]	Disables the <FUNC> button.
[P IN P]	Switches [OFF]/[USER1]/[USER2]/[USER3] in [P IN P]. (➔ page 125)
[SUB MEMORY]	Displays the sub memory list. (➔ page 130)
[SYSTEM SELECTOR]	Switches the [SYSTEM SELECTOR] setting. (➔ page 77)
[SYSTEM DAYLIGHT VIEW]	Switches the [SYSTEM DAYLIGHT VIEW] setting. (➔ page 75)
[FREEZE]	Temporarily pauses the image. (➔ page 105)
[WAVEFORM MONITOR]	Displays the waveform of the input signal. (➔ page 105)
[LENS MEMORY LOAD]	Calls the registered lens memory. (➔ page 122)
[LEFT/RIGHT SWAP]*1	Switches the flip horizontal settings. (➔ page 93)

*1 Only for PT-DZ13KE, PT-DS12KE, PT-DW11KE

4) Press the <ENTER> button.

[DATE AND TIME]

Set the time zone, date, and time of the built-in clock of the projector.

Setting the time zone

1) Press ▲▼ to select [DATE AND TIME].

2) Press the <ENTER> button.

- The [DATE AND TIME] screen is displayed.

3) Press ▲▼ to select [TIME ZONE].

4) Press ◀▶ to switch [TIME ZONE].

Setting the date and time manually

1) Press ▲▼ to select [DATE AND TIME].

2) Press the <ENTER> button.

- The [DATE AND TIME] screen is displayed.

3) Press ▲▼ to select [ADJUST CLOCK].

4) Press the <ENTER> button.

- The [ADJUST CLOCK] screen is displayed.

5) Press ▲▼ to select an item, and press ◀▶ to set the local date and time.

6) Press ▲▼ to select [APPLY], and press the <ENTER> button.

- The setting of the date and time will be completed.

Setting the date and time automatically

- 1) Press ▲▼ to select [DATE AND TIME].
- 2) Press the <ENTER> button.
 - The [DATE AND TIME] screen is displayed.
- 3) Press ▲▼ to select [ADJUST CLOCK].
- 4) Press the <ENTER> button.
 - The [ADJUST CLOCK] screen is displayed.
- 5) Press ▲▼ to select [NTP SYNCHRONIZATION], and press ◀▶ to change the setting to [ON].
- 6) Press ▲▼ to select [APPLY], and press the <ENTER> button.
 - The setting of the date and time will be completed.

Note

- To set the date and time automatically, the projector must be connected to the network.
- If synchronization with the NTP server fails just after [NTP SYNCHRONIZATION] is turned [ON], or if [NTP SYNCHRONIZATION] is turned [ON] while the NTP server is not set, [NTP SYNCHRONIZATION] will return to [OFF].
- Access the projector via a web browser to set the NTP server. Refer to “[Adjust clock] page” (➔ page 145) for details.

[LENS CALIBRATION]

Automatically set the lens shift limit values and home position for the projector.

- 1) Press ▲▼ to select [LENS CALIBRATION].
- 2) Press the <ENTER> button.
 - The confirmation screen is displayed.
- 3) Press ◀▶ to select [OK], and press the <ENTER> button.
 - To cancel, select [CANCEL].
 - The lens moves up, down, left, and right to automatically set the lens shift limit values and home position.
 - The lens stops to complete the calibration.

Note

- [PROGRESS] is displayed on the menu during lens calibration. Cannot cancel mid-operation.
- When lens calibration executes correctly, [COMPLETE] is displayed and [INCOMPLETE] is displayed when it does not execute correctly.
- Pressing the <FOCUS> button on the remote control for at least three seconds will also display the confirmation screen for lens calibration execution.

[LENS MEMORY]

Save and load the focus position, shift position, and zoom position of an adjusted lens.

Saving lens position

- 1) Press ▲▼ to select [LENS MEMORY].
- 2) Press the <ENTER> button.
- 3) Press ▲▼ to select [LENS MEMORY SAVE].
- 4) Press the <ENTER> button.
 - The [LENS MEMORY SAVE] screen is displayed.
- 5) Press ▲▼ to select the item to save, and press the <ENTER> button.
- 6) When the confirmation screen is displayed, press ◀▶ to select [OK], and press the <ENTER> button.
 - The [LENS MEMORY NAME INPUT] screen is displayed.
- 7) Press ▲▼◀▶ to select the text, and press the <ENTER> button to enter the text.
- 8) After the name is input, press ▲▼◀▶ to select [OK], and press the <ENTER> button.
 - The registration completes and returns to the [LENS MEMORY SAVE] screen.
 - If you press ▲▼◀▶ to select [CANCEL] and then press the <ENTER> button, the lens memory will not be saved.

- If you press ▲▼◀▶ to select [DEFAULT] and press the <ENTER> button, the entered name will not be registered and the default name will be used.
- If you select [OK] without entering any characters and press the <ENTER> button, the default name will be used.

Loading the lens position

- 1) Press ▲▼ to select [LENS MEMORY].
- 2) Press the <ENTER> button.
- 3) Press ▲▼ to select [LENS MEMORY LOAD].
- 4) Press the <ENTER> button.
 - The [LENS MEMORY LOAD] screen is displayed.
- 5) Press ▲▼ to select the item to load, and press the <ENTER> button.
- 6) When the confirmation screen is displayed, press ◀▶ to select [OK], and press the <ENTER> button.
 - The lens moves automatically to the registered shift, zoom, and focus positions.

Note

- Lens memory is not guaranteed to be 100 % reproduced.
- The zoom and focus positions may have shifted after lens memory was loaded. Readjust as necessary.
- Beware of shift, as errors in zoom position are particularly significant.
- When a lens is replaced, readjust and save the lens memory again.
- If a lens without zoom function is used, the lens memory of the zoom position does not operate.
- When [LENS MEMORY LOAD] is assigned to the <FUNC> button, the lens memory is loaded in order each time you press the <FUNC> button.

Deleting a lens memory

- 1) Press ▲▼ to select [LENS MEMORY].
- 2) Press the <ENTER> button.
- 3) Press ▲▼ to select [LENS MEMORY EDIT].
- 4) Press the <ENTER> button.
 - The [LENS MEMORY EDIT] screen is displayed.
- 5) Press ▲▼ to select [LENS MEMORY DELETE].
- 6) Press the <ENTER> button.
 - The [LENS MEMORY DELETE] screen is displayed.
- 7) Press ▲▼ to select the item to delete, and press the <ENTER> button.
- 8) When the confirmation screen is displayed, press ◀▶ to select [OK], and press the <ENTER> button.

Changing the lens memory name

- 1) Press ▲▼ to select [LENS MEMORY].
- 2) Press the <ENTER> button.
- 3) Press ▲▼ to select [LENS MEMORY EDIT].
- 4) Press the <ENTER> button.
 - The [LENS MEMORY EDIT] screen is displayed.
- 5) Press ▲▼ to select [LENS MEMORY NAME CHANGE].
- 6) Press the <ENTER> button.
 - The [LENS MEMORY NAME CHANGE] screen is displayed.
- 7) Press ▲▼ to select the name to change, and press the <ENTER> button.
 - The [LENS MEMORY NAME INPUT] screen is displayed.
- 8) Press ▲▼◀▶ to select the text, and press the <ENTER> button to enter the text.

9) After the name is changed, press ▲▼◀▶ to select [OK], and press the <ENTER> button.

- The registration completes and returns to the [LENS MEMORY NAME CHANGE] screen.
- If you press ▲▼◀▶ to select [CANCEL] and then press the <ENTER> button, the changed name will not be registered.
- If you press ▲▼◀▶ to select [DEFAULT] and press the <ENTER> button, the changed name will not be registered and the default name will be used.
- If you select [OK] without entering any characters and press the <ENTER> button, the default name will be used.

[SAVE ALL USER DATA]

Save the various setting values as a backup in the built-in memory of the projector.

- 1) Press ▲▼ to select [SAVE ALL USER DATA].
- 2) Press the <ENTER> button.
 - The [SECURITY PASSWORD] screen is displayed.
- 3) Enter a security password and press the <ENTER> button.
- 4) When the confirmation screen is displayed, press ◀▶ to select [OK], and press the <ENTER> button.
 - [PROGRESS] is displayed while saving data.

[LOAD ALL USER DATA]

Load the various setting values saved as a backup in the built-in memory of the projector.

- 1) Press ▲▼ to select [LOAD ALL USER DATA].
- 2) Press the <ENTER> button.
 - The [SECURITY PASSWORD] screen is displayed.
- 3) Enter a security password and press the <ENTER> button.
- 4) When the confirmation screen is displayed, press ◀▶ to select [OK], and press the <ENTER> button.

Note

- The projector will go into the standby status to reflect the setting values when [LOAD ALL USER DATA] is executed.
- Data registered from a computer is not included in [ALL USER DATA].

[INITIALIZE]

Return various setting values to their factory default settings.

- 1) Press ▲▼ to select [INITIALIZE].
- 2) Press the <ENTER> button.
 - The [SECURITY PASSWORD] screen is displayed.
- 3) Enter a security password and press the <ENTER> button.
 - The [INITIALIZE] screen is displayed.
- 4) Press ▲▼ to select an item to initialize.

[ALL USER DATA]	Returns all setting items including [REGISTERED SIGNAL], [NETWORK SETUP], [E-mail set up], and [USER LOGO] to factory default settings. The projector will go into the standby status to reflect the setting values.
[REGISTERED SIGNAL]	Deletes all the setting values saved for each input signal. To delete only a part of a registered signal, perform the procedure described in “Deleting the registered signal” (➔ page 128).
[NETWORK/E-MAIL]	Returns [NETWORK SETUP] and [E-mail set up] to factory default settings.
[LOGO IMAGE]	Deletes the image registered in [USER LOGO].

- 5) Press the <ENTER> button.
- 6) When the confirmation screen is displayed, press ◀▶ to select [OK], and press the <ENTER> button.

[SERVICE PASSWORD]

This function is used by a service person.

[P IN P] menu

On the menu screen, select [P IN P] from the main menu, and select an item from the sub-menu.

Refer to “Navigating through the menu” (⇒ page 65) for the operation of the menu screen.

- After selecting the item, press ▲▼◀▶ to set.

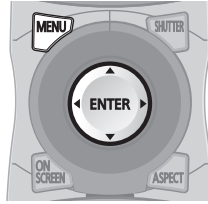

Using P IN P function

Locate a separate, small sub screen in the main screen to project two images simultaneously.

- 1) Press ▲▼ to select [P IN P MODE].
- 2) Press the <ENTER> button.
 - The [P IN P MODE] screen is displayed.
- 3) Press ▲▼ to select a function.

[OFF]	P IN P function is not used.
[USER1]	The items set in “Setting P IN P function” (⇒ page 125) are used in P IN P function.
[USER2]	
[USER3]	

- 4) Press the <ENTER> button.

Setting P IN P function

P IN P function settings can be saved to [USER1], [USER2], and [USER3].

- 1) Press ▲▼ to select [P IN P MODE].
- 2) Press the <ENTER> button.
 - The [P IN P MODE] screen is displayed.
- 3) Press ▲▼ to select the desired mode from [USER1], [USER2], and [USER3], and press the <ENTER> button.
- 4) Press ▲▼ to select [MAIN WINDOW] or [SUB WINDOW], and press the <ENTER> button.
- 5) Press ▲▼ to select the input terminal to be displayed in the window, and press the <ENTER> button.
- 6) Press ▲▼ to select an item.

[SIZE]	Set the window display size between 10 % and 100 %.
[POSITION]	Set the display position of the window within the screen.
[CLOCK PHASE]	When the sub window is input from the <RGB 1 IN> terminal or the <RGB 2 IN> terminal and a flickering image or smeared outline appears, set between 0 and +31.

- 7) If [SIZE] is selected in Step 6), press the <ENTER> button.
 - The sub-menu is displayed.
- 8) Press ▲▼ to select an item.
- 9) Press ◀▶ to make adjustment, and press the <MENU> button.
- 10) If [POSITION] is selected in Step 6), press the <ENTER> button.
- 11) Press ▲▼◀▶ to adjust the position, and press the <MENU> button.

12) If [CLOCK PHASE] is selected in Step 6), press ◀▶ to make adjustment.

13) Press ▲▼ to select [FRAME LOCK].

14) Press ◀▶ to switch the item.

[MAIN WINDOW]	Set frame lock to the input signal set in the main window.
[SUB WINDOW]	Set frame lock to the input signal set in the sub window.

15) Press ▲▼ to select [TYPE].

16) Press ◀▶ to switch the item.

[MAIN WINDOW]	The main window has display priority.
[SUB WINDOW]	The sub window has display priority.

Note

- The P IN P function may not be available for some signals being input or terminals being selected. Refer to “Two-window display combination list” (▶ page 176) for details.
- The main window setting values are applied to image adjustment values such as [PICTURE MODE], [GAMMA], and [COLOR TEMPERATURE].
- On the main screen (when no menu is displayed), press ◀▶ to switch the sizes and positions of the main window and sub window while P IN P is operating.
- When [FRAME RESPONSE] is set to other than [NORMAL], [P IN P] cannot be set.
- 3D images cannot be displayed in P IN P. (Only for PT-DZ13KE, PT-DS12KE, PT-DW11KE)
- The P IN P state continues while the P IN P function is used, even if 3D images of the simultaneous system are displayed. (Only for PT-DZ13KE, PT-DS12KE, PT-DW11KE)

[TEST PATTERN] menu

On the menu screen, select [TEST PATTERN] from the main menu.
Refer to “Navigating through the menu” (➔ page 65) for the operation of the menu screen.

- Press ◀▶ to switch.

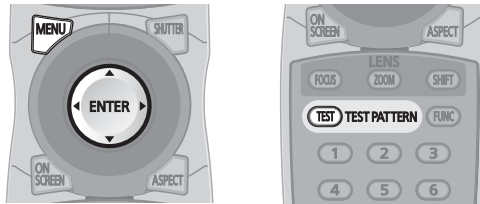

[TEST PATTERN]

Display the test pattern built-in to the projector.

Settings of position, size, and other factors will not be reflected in test patterns. Make sure to display the input signal before performing various adjustments.

1) Press ◀▶ to switch the [TEST PATTERN] item.

- The items will switch each time you press the button.

Menu screen + All white	
Menu screen + All black	
Menu screen + Window	
Menu screen + Window (inversion)	
Menu screen + Color bar (vertical)	Displays test patterns with the menu screen. Select a test pattern so that it is easy to make various adjustments.
Menu screen + Color bar (horizontal)	
Menu screen + 16:9/4:3 aspect frame	
Menu screen + Focus	
Menu screen + Entry screen	Displays the menu screen and input signal. Built-in test patterns are not displayed.

Note

- Press the <ON SCREEN> button on the remote control while the test pattern is displayed to hide the menu screen.

Changing color or a focus test pattern

When the “Menu Screen + Focus” test pattern is displayed, the color can be changed.

1) Press ◀▶ to select the “Menu Screen + Focus” test pattern.

2) Press the <ENTER> button.

- The [TEST PATTERN COLOR] screen is displayed.

3) Press ▲▼ to select a color, and press the <ENTER> button.

- The test pattern color changed to the color selected.

Note

- The test pattern color settings return to [WHITE] when the projector is switched off.
- Colors of the test patterns other than focus test patterns cannot be changed.

[SIGNAL LIST] menu

On the menu screen, select [SIGNAL LIST] from the main menu.
Refer to “Navigating through the menu” (➔ page 65) for the operation of the menu screen.

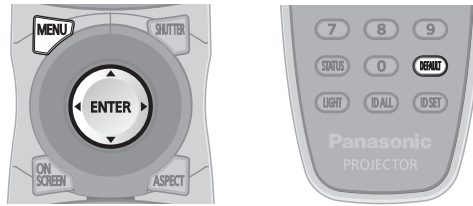

■ Registered signal details

Memory number: A1 (1-2)



When the address number (A1, A2, ... L7, L8) signal is registered

- A name can be set for each sub memory (➔ page 130).

Registering new signals

After a new signal is input and the <MENU> button on the remote control or the control panel is pressed, the registration is completed and the [MAIN MENU] screen is displayed.

Note

- Up to 96 signals, including sub memories, can be registered to the projector.
- There are 12 pages (eight memories of A through L, with eight memories possible on each page) for memory numbers, and the signal is registered to the lowest number that is available. If there is no available memory number it will be overwritten from the oldest signal.
- The names to be registered are automatically determined by the input signals and memory numbers.
- If a menu is being displayed, the new signals will be registered at the instant they are input.

Renaming the registered signal

Registered signals can be renamed.

- 1) Press **▲▼◀▶** to select the signal of which name is to be changed.
- 2) Press the <ENTER> button.
 - The [REGISTERED SIGNAL STATUS] screen is displayed.
 - The memory number, input terminal, input signal name, frequency, synch polarity, etc., are displayed.
 - Press the <MENU> button to return to the [SIGNAL LIST] screen.
- 3) Press the <ENTER> button.
 - The [REGISTERED SIGNAL SETUP] screen is displayed.
- 4) Press **▲▼** to select [SIGNAL NAME CHANGE].
- 5) Press the <ENTER> button.
 - The [SIGNAL NAME CHANGE] screen is displayed.
- 6) Press **▲▼◀▶** to select the text, and press the <ENTER> button to enter the text.
- 7) After the name is changed, press **▲▼◀▶** to select [OK], and press the <ENTER> button.
 - The registration is completed and the [REGISTERED SIGNAL SETUP] screen returns.
 - When pressing **▲▼◀▶** to select [CANCEL] and pressing the <ENTER> button, the changed signal name will not be registered and an automatically registered signal name will be used.

Deleting the registered signal

Registered signals can be deleted.

- 1) Press **▲▼◀▶** to select the signal to delete.
- 2) Press the <DEFAULT> button.
 - The [REGISTERED SIGNAL DELETE] screen is displayed.

- To cancel the deletion, press the <MENU> button to return to the [REGISTERED SIGNAL LIST] screen.

3) Press the <ENTER> button.

- The selected signal will be deleted.

Note

- A registered signal can also be deleted from [REGISTERED SIGNAL DELETE] on the [REGISTERED SIGNAL SETUP] screen.

Protecting the registered signal

1) Press ▲▼◀▶ to select the signal to protect.

2) Press the <ENTER> button.

- The [REGISTERED SIGNAL STATUS] screen is displayed.

3) Press the <ENTER> button.

- The [REGISTERED SIGNAL SETUP] screen is displayed.

4) Press ▲▼ to select [LOCK].

5) Press ◀▶ to switch the item.

- The items will switch each time you press the button.

[OFF]	The signal is not protected.
[ON]	The signal is protected.

Note

- When [LOCK] is set to [ON], signal deletion, image adjustment, and automatic setup are not available. To perform these operations, set [LOCK] to [OFF].
- A signal can be registered to the sub memory even if it is protected.
- Even a protected signal will be deleted if [INITIALIZE] is executed.

Expanding signal lock-in range

1) Press ▲▼◀▶ to select the signal to set.

2) Press the <ENTER> button.

- The [REGISTERED SIGNAL STATUS] screen is displayed.

3) Press the <ENTER> button.

- The [REGISTERED SIGNAL SETUP] screen is displayed.

4) Press ▲▼ to select [LOCK-IN RANGE].

5) Press ◀▶ to switch the item.

- The items will switch each time you press the button.

[NARROW]	Select in most cases.
[WIDE]	Widens the lock-in range.

Note

- Switch the range that determines that a signal to be input is the same signal that is already registered.
- To prioritize the determination that it is the same signal that is already registered, set to the [WIDE] setting.
- Use in cases such as when the synchronizing frequency of a signal to be input has changed slightly, or multiple signal lists are registered.
- Can only be used when a signal is input from the <RGB 1 IN> terminal, <RGB 2 IN> terminal, <DVI-D IN> terminal, or <HDMI IN> terminal.
- When [WIDE] is set, the image may appear distorted because a signal is determined to be the same signal even if a synchronizing frequency changes slightly.
- When a signal to be input corresponds to multiple signals set in [WIDE], a registered signal with a high memory number receives priority. Example: a signal to be input that corresponds to memory numbers A2, A4 and B1 will be determined to be B1.
- When a registration signal is deleted, the settings are also deleted.
- In an environment where multiple types of signals are input to the same terminal, signals are sometimes not determined correctly when the setting is set to [WIDE].

Sub memory

The projector has a sub memory function that can register the multiple image adjustment data, even if it is recognized as the same signal by the frequency or format of the synchronization signal source.

Use this function when you need to adjust the picture quality such as switching of the aspect ratio or white balance by the same synchronization signal source. The sub memory includes all the data that can be adjusted for each signal, such as the screen aspect ratio and data adjusted in the [PICTURE] item ([CONTRAST], [BRIGHTNESS], etc.).

Registering to the sub memory

- 1) **Press ◀▶ on the normal screen (when the menu is not displayed).**
 - The sub memory registration screen is displayed if the sub memory is not registered. Proceed to Step 3).
 - A list of sub memories registered to the signal currently input is displayed.
 - By selecting [SUB MEMORY] in the [PROJECTOR SETUP] menu → [FUNCTION BUTTON], the <FUNC> button can be used instead of ◀▶.
- 2) **Press ▲▼◀▶ to select the sub memory number to register in [SUB MEMORY LIST].**
- 3) **Press the <ENTER> button.**
 - The [SIGNAL NAME CHANGE] screen is displayed.
- 4) **Press ▲▼◀▶ to select [OK], and press the <ENTER> button.**
 - To rename the registered signal, follow the procedure in Steps 6) and 7) in "Renaming the registered signal" (➔ page 128).

Switching to the sub memory

- 1) **Press ◀▶ on the normal screen (when the menu is not displayed).**
 - A list of sub memories registered to the signal currently input is displayed.
- 2) **Press ▲▼◀▶ to select the signal to switch in [SUB MEMORY LIST].**
- 3) **Press the <ENTER> button.**
 - This switches to the signal selected in Step 2).

Deleting the sub memory

- 1) **Press ◀▶ on the normal screen (when the menu is not displayed).**
 - The [SUB MEMORY LIST] screen is displayed.
- 2) **Press ▲▼◀▶ to select the sub memory to delete, and press the <DEFAULT> button.**
 - The [REGISTERED SIGNAL DELETE] screen is displayed.
 - To cancel the deletion, press the <MENU> button to return to the [SUB MEMORY LIST] screen.
- 3) **Press the <ENTER> button.**
 - The selected sub memory will be deleted.

[SECURITY] menu

On the menu screen, select [SECURITY] from the main menu, and select an item from the sub-menu.

Refer to “Navigating through the menu” (➔ page 65) for the operation of the menu screen.

- When the projector is used for the first time
Initial password: Press ▲▶▼◀▲▶▼◀ in order, and press the <ENTER> button.
- After selecting the item, press ▲▶▼◀ to set.

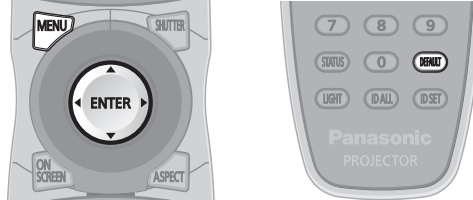

Attention

- When you select the [SECURITY] menu and press the <ENTER> button, entering a password is required. Enter the preset password and then continue operations of the [SECURITY] menu.
- When the password has been changed previously, enter the changed password, and press the <ENTER> button.

Note

- The entered password is displayed with*marks on the screen.
- An error message is displayed on the screen when the entered password is incorrect. Re-enter the correct password.

[SECURITY PASSWORD]

The [SECURITY PASSWORD] screen is displayed when the power is turned on. When the entered password is incorrect, the operation will be restricted to the power standby <ϕ> button, the <SHUTTER> button, and the <LENS> (<FOCUS>, <ZOOM>, and <SHIFT>) buttons.

- 1) Press ▲▼ to select [SECURITY PASSWORD].
- 2) Press ◀▶ to switch the item.
 - The items will switch each time you press the button.

[OFF]	Disables the security password entry.
[ON]	Enables the security password entry.

Note

- The [SECURITY PASSWORD] setting is set to [OFF] by the factory default or when [ALL USER DATA] in [INITIALIZE] (➔ page 124) is executed.
- Change the password periodically that is hard to guess.
- The security password is enabled after setting [SECURITY PASSWORD] to [ON] and turning the <MAIN POWER> switch to <OFF>.

[SECURITY PASSWORD CHANGE]

Change the security password.

- 1) Press ▲▼ to select [SECURITY PASSWORD CHANGE].
- 2) Press the <ENTER> button.
 - The [SECURITY PASSWORD CHANGE] screen is displayed.
- 3) Press ▲▶▼◀ and the number (<0> - <9>) buttons to set the password.
 - Up to eight button operations can be set.
- 4) Press the <ENTER> button.
- 5) Re-enter the password for the confirmation.
- 6) Press the <ENTER> button.

Note

- The entered password is displayed with*marks on the screen.
- An error message is displayed on the screen when the entered password is incorrect. Re-enter the correct password.

[DISPLAY SETTING]

Overlap the security message (text or image) over the projecting image.

1) Press ▲▼ to select [DISPLAY SETTING].

2) Press ◀▶ to switch the item.

- The items will switch each time you press the button.

[OFF]	The text display is disabled.
[TEXT]	The text display is enabled.
[USER LOGO]	Displays the image registered by the user.

Note

- To create/register the [USER LOGO] image, use "Logo Transfer Software" included in the supplied CD-ROM.

[TEXT CHANGE]

Change the text displayed when the text display is enabled by selecting [TEXT] in [DISPLAY SETTING].

1) Press ▲▼ to select [TEXT CHANGE].

2) Press the <ENTER> button.

- The [TEXT CHANGE] screen is displayed.

3) Press ▲▼◀▶ to select the text, and press the <ENTER> button to enter the text.

4) Press ▲▼◀▶ to select [OK], and press the <ENTER> button.

- The text is changed.

[CONTROL DEVICE SETUP]

Enable/disable the button operations on the control panel and the remote control.

1) Press ▲▼ to select [CONTROL DEVICE SETUP].

2) Press the <ENTER> button.

- The [CONTROL DEVICE SETUP] screen is displayed.

3) Press ▲▼ to select [CONTROL PANEL] or [REMOTE CONTROL].

[CONTROL PANEL]	You can set the limitation on the control from the control panel.
[REMOTE CONTROL]	You can set the limitation on the control from the remote control.

4) Press the <ENTER> button.

- The [CONTROL PANEL] screen or the [REMOTE CONTROL] screen is displayed.

5) Press ▲▼ to select [CONTROL PANEL] or [REMOTE CONTROL].

6) Press ◀▶ to switch the item.

- You can set the operation restriction from the control panel or the remote control.

[ENABLE]	Enables all button operations.
[DISABLE]	Disables all button operations.
[USER]	Operation of all buttons can be enabled/disabled separately. Refer to "Enabling/disabling any button" (➔ page 132) for details.

7) Press ▲▼ to select [APPLY], and press the <ENTER> button.

- The confirmation screen is displayed.

8) Press ◀▶ to select [OK], and press the <ENTER> button.

Enabling/disabling any button

1) Press ▲▼ to select [CONTROL DEVICE SETUP].

- 2) Press the <ENTER> button.
 - The [CONTROL DEVICE SETUP] screen is displayed.
- 3) Press ▲▼ to select [CONTROL PANEL] or [REMOTE CONTROL].
- 4) Press the <ENTER> button.
- 5) Press ▲▼ to select [CONTROL PANEL] or [REMOTE CONTROL].
- 6) Press ◀▶ to switch [USER].
- 7) Press ▲▼ to select the button item to set.
 - When [INPUT SELECT BUTTON] is selected, press the <ENTER> button, and then press ▲▼ to select the button to set.

	Buttons that can be set	
	[CONTROL PANEL]	[REMOTE CONTROL]
[POWER BUTTON]	Power standby <⏻> button, power on < > button	
[INPUT SELECT BUTTON]	<VIDEO> button, <RGB1> button, <RGB2> button, <DVI-D> button, <HDMI> button, and <SDI 1/2> button*1	
[MENU BUTTON]	<MENU> button	
[LENS BUTTON]	<LENS> button	<FOCUS> button, <ZOOM> button, <SHIFT> button
[AUTO SETUP BUTTON]	<AUTO SETUP> button	
[SHUTTER BUTTON]	<SHUTTER> button	
[ASPECT BUTTON]	—	<ASPECT> button
[ON SCREEN BUTTON]	—	<ON SCREEN> button
[OTHER BUTTON]	▲▼◀▶, <ENTER> button	Buttons not listed above

*1 Only for PT-DZ13KE, PT-DS12KE, PT-DZ10KE

- 8) Press ◀▶ to switch the item.

[ENABLE]	Enables button operations.
[DISABLE]	Disables button operations.

- The following items are available when [SDI1/2 BUTTON] is selected in [INPUT SELECT BUTTON] in PT-DZ13KE and PT-DS12KE.

[TOGGLE]	Switches between SDI1 and SDI2 when the button is operated.
[SDI1]	Fixes to SDI1.
[SDI2]	Fixes to SDI2.
[DISABLE]	Disables button operations.

- When [INPUT SELECT BUTTON] is selected in Step 7), press the <MENU> button to return to the [CONTROL PANEL] screen or the [REMOTE CONTROL] screen.

- 9) Press ▲▼ to select [APPLY], and press the <ENTER> button.

- The confirmation screen is displayed.

- 10) Press ◀▶ to select [OK], and press the <ENTER> button.

Note

- When a button operation is performed on the device set to [DISABLE], the [CONTROL DEVICE PASSWORD] screen is displayed. Enter the control device password.
- The [CONTROL DEVICE PASSWORD] screen will disappear when there is no operation for approx. 10 seconds.
- If the operations of both [CONTROL PANEL] and [REMOTE CONTROL] are set to [DISABLE], the projector cannot be turned off (cannot enter standby).
- When the setting has completed, the menu screen will disappear. To operate continuously, press the <MENU> button to display the main menu.
- Even when button operation on the remote control is disabled, the <ID SET> button and the <ID ALL> button are enabled.

[CONTROL DEVICE PASSWORD CHANGE]

The control device password can be changed.

- 1) Press ▲▼ to select [CONTROL DEVICE PASSWORD CHANGE].
- 2) Press the <ENTER> button.
 - The [CONTROL DEVICE PASSWORD CHANGE] screen is displayed.
- 3) Press ▲▼◀▶ to select the text, and press the <ENTER> button to enter the text.

4) Press ▲▼◀▶ to select [OK], and press the <ENTER> button.

- To cancel, select [CANCEL].

Attention

- The initial password is "AAAA" by the factory default or when [ALL USER DATA] in [INITIALIZE] (▶ page 124) is executed.
- Change the password periodically that is hard to guess.

[NETWORK] menu

On the menu screen, select [NETWORK] from the main menu, and select an item from the sub-menu.

Refer to “Navigating through the menu” (➔ page 65) for the operation of the menu screen.

- After selecting the item, press ▲▼◀▶ to set.

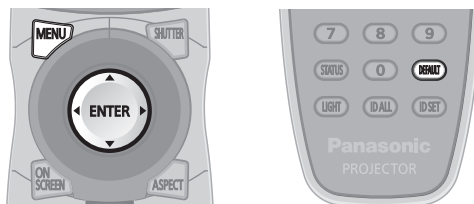

[NETWORK SETUP]

Perform the initial setting of the network before using the network function.

- 1) Press ▲▼ to select [NETWORK SETUP].
- 2) Press the <ENTER> button.
 - The [NETWORK SETUP] screen is displayed.
- 3) Press ▲▼ to select an item, and change the settings according to the operation instructions of the menu.

[PROJECTOR NAME]	Change the setting when using a DHCP server.
[DHCP]	Set to [ON] when obtaining an IP address automatically using a DHCP server. Set to [OFF] when not using a DHCP server.
[IP ADDRESS]	Enter the IP address when not using a DHCP server.
[SUBNET MASK]	Enter the subnet mask when not using a DHCP server.
[DEFAULT GATEWAY]	Enter the default gateway address when not using a DHCP server.
[STORE]	Save the current network settings.

- 4) Press ▲▼ to select [STORE], and press the <ENTER> button.
- 5) When the confirmation screen is displayed, press ◀▶ to select [OK], and press the <ENTER> button.

Note

- When using a DHCP server, confirm that the DHCP server is running.
- Consult your network administrator regarding the IP address, subnet mask, and default gateway.
- When [Art-Net SETUP] is set to [ON(2.X.X.X)] or [ON(10.X.X.X)], [NETWORK SETUP] cannot be selected.

[NETWORK CONTROL]

Set up the control method of the network.

- 1) Press ▲▼ to select [NETWORK CONTROL].
- 2) Press the <ENTER> button.
 - The [NETWORK CONTROL] screen is displayed.
- 3) Press ▲▼ to select an item, and press ◀▶ to change the setting.

[WEB CONTROL]	Set to [ON] to control with the web browser.
[PJLink CONTROL]	Set to [ON] to control with the PJLink protocol.
[COMMAND CONTROL]	Set to [ON] to control with the <SERIAL IN>/<SERIAL OUT> terminal control command format (➔ page 174). Refer to “Control commands via LAN” (➔ page 169).
[COMMAND PORT]	Set the port number used for command control.
[CRESTRON RoomView]	Set to [ON] to control with RoomView of Crestron Electronics, Inc.
[AMX D.D.]	Set to [ON] to control with the controller of AMX Corporation. Setting this function to [ON] enables detection through “AMX Device Discovery”. For details, refer to the website of AMX Corporation. URL http://www.amx.com/
[STORE]	Save the current network control settings.

- 4) Press ▲▼ to select [STORE], and press the <ENTER> button.
- 5) When the confirmation screen is displayed, press ◀▶ to select [OK], and press the <ENTER> button.

[NETWORK STATUS]

Display the status of the projector network.

- 1) Press ▲▼ to select [NETWORK STATUS].
- 2) Press the <ENTER> button.
 - The [NETWORK STATUS] screen is displayed.

[Art-Net SETUP]

Make settings to use the Art-Net function.

- 1) Press ▲▼ to select [Art-Net SETUP].
- 2) Press ◀▶ to select an item.
 - The items will switch each time you press the button.

[OFF]	Disables the Art-Net function.
[ON(2.X.X.X)]	Enables the Art-Net function and sets the IP address to 2.X.X.X.
[ON(10.X.X.X)]	Enables the Art-Net function and sets the IP address to 10.X.X.X.
[ON(MANUAL)]	Enables the Art-Net function and uses the IP address set in [NETWORK SETUP].

- When an item other than [OFF] is selected, proceed to Step 3).

- 3) Press the <ENTER> button.
 - The [Art-Net SETUP] screen is displayed.
- 4) Press ▲▼ to select an item, and press ◀▶ to switch the setting.

[NET]	Enter [NET] to be used when the projector processes Art-Net.
[SUB NET]	Enter [SUB NET] to be used when the projector processes Art-Net.
[UNIVERSE]	Enter [UNIVERSE] to be used when the projector processes Art-Net.
[START ADDRESS]	Enter [START ADDRESS] to be used when the projector processes Art-Net.

- 5) Press ▲▼ to select [STORE], and press the <ENTER> button.
- 6) When the confirmation screen is displayed, press ◀▶ to select [OK], and press the <ENTER> button.

Note

- When [ON(2.X.X.X)] or [ON(10.X.X.X)] is selected, the IP address is searched and set automatically.

Network connections

The projector has a network function, and the following operations are available from the computer using the web control.

- Setting and adjustment of the projector
- Display of the projector status
- Sending of E-mail messages when there is a problem with the projector

The projector supports “Crestron RoomView”, and the following application software of Crestron Electronics, Inc. can be used.

- RoomView Express
- Fusion RV
- RoomView Server Edition

Attention

- When a LAN cable is directly connected to the projector, the network connection must be made indoors.

Note

- “Crestron RoomView” is a system of Crestron Electronics, Inc. that collectively manages and controls devices on multiple systems connected to a network using a computer.
- For details of “Crestron RoomView”, refer to the website of Crestron Electronics, Inc. (English only)
URL <http://www.crestron.com>
- To download “RoomView Express”, go to the following website of Crestron Electronics, Inc. (English only)
URL <http://www.crestron.com/getroomview>
- A LAN cable is required to use the network function.

■ Example of a normal network connection

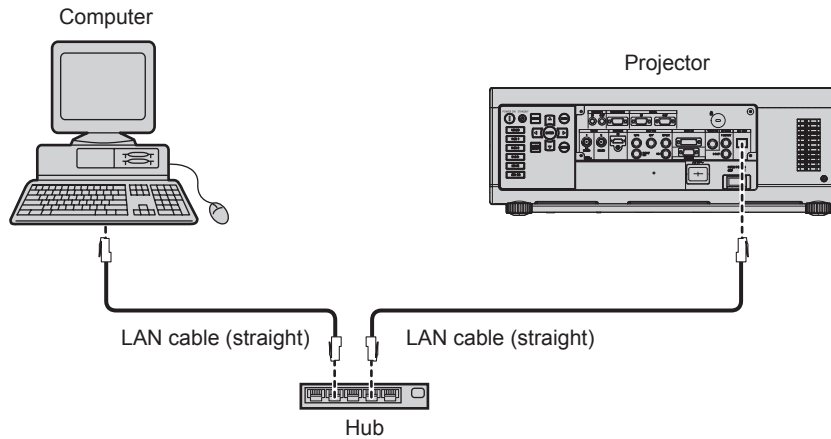

- A web browser is required to use this function. Confirm that the web browser can be used beforehand.
Compatible OS: Windows XP/Windows Vista/Windows 7/Windows 8, Mac OS X v10.4/v10.5/v10.6/v10.7/v10.8
Compatible browser: Internet Explorer 7.0/8.0/9.0/10.0, Safari 4.0/5.0/6.0 (Mac OS)
- Communication with an E-mail server is required to use the E-mail function. Confirm that the E-mail can be used beforehand.
- Use a LAN cable that is compatible with category 5 or higher.
- Use a LAN cable of 100 m (328'1") or shorter.

Name and function of network function parts

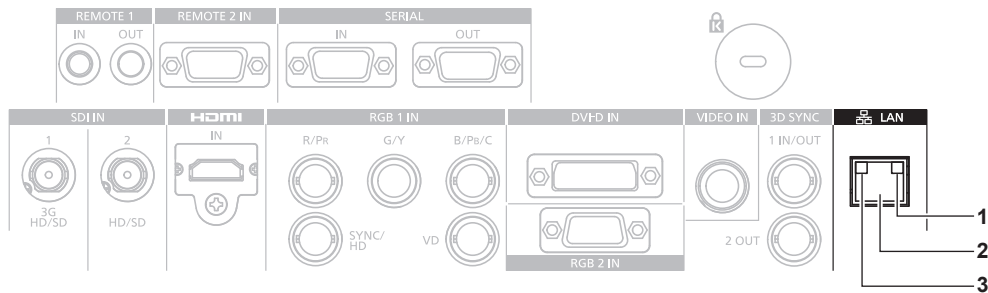

- 1 LAN LINK/ACT lamp (green)**
Lights on when connected.
Flashes when transmitting/receiving data.
- 2 <LAN> terminal (10Base-T/100Base-TX)**
Used to connect the LAN cable here.
- 3 LAN10/100 lamp (yellow)**
Lights on when connected to the 100Base-TX.

Accessing from the web browser

- 1) Start up the web browser on the computer.
- 2) Enter the IP address set on the projector into the URL entry field of the web browser.
- 3) Enter the user name and the password.
 - The factory default setting of the user name is user1 (user rights)/admin1 (administrator rights) and the password is panasonic (lower case).

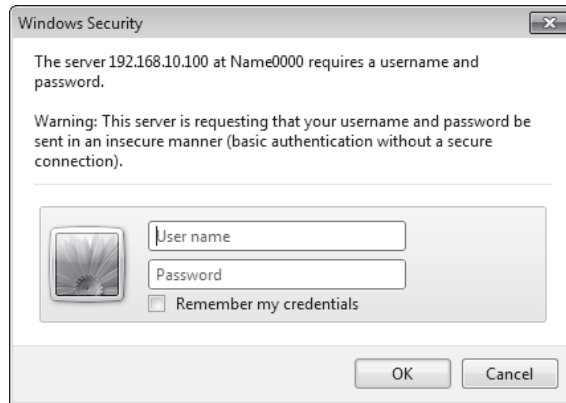

- 4) Click OK.
 - The [Projector status] page is displayed.

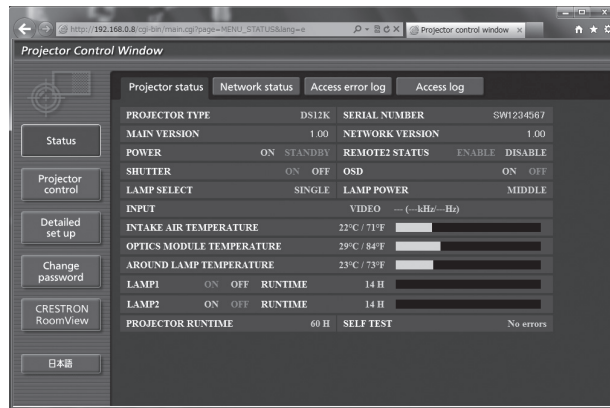

Note

- If you use a web browser to control the projector, set [WEB CONTROL] to [ON] in [NETWORK CONTROL] (➔ page 135).
- Do not perform setting or control simultaneously by starting up multiple web browsers. Do not set or control the projector from multiple computers.
- Change the password first. (➔ page 151)
- The administrator rights allow use of all functions. The user rights allow use of [Projector status] (➔ page 140), confirmation of the error information page (➔ page 141), [Network status] (➔ page 142), [Basic control] (➔ page 143), and [Change password] (➔ page 151) only.
- Access will be locked for few minutes when an incorrect password is entered three times consecutively.
- Some items on the projector setting page use the Javascript function of the web browser. The projector may not be able to be controlled properly if it is set with a browser that does not have this function enabled.
- If the screen for the web control is not displayed, consult your network administrator.
- While updating the screen for the web control, the screen may become white for a moment, but it is not a malfunction.

Descriptions of items

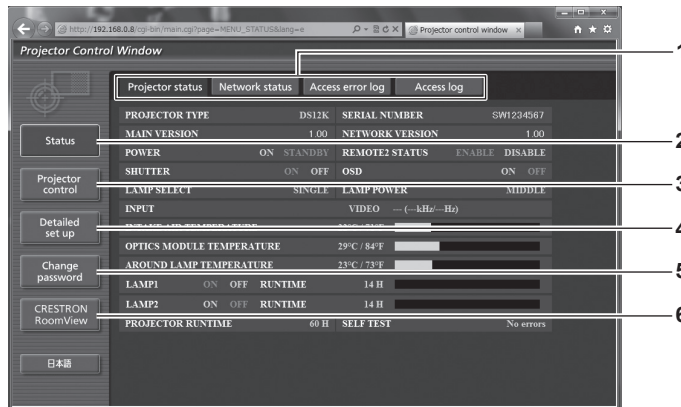

- | | |
|--|--|
| <p>1 Page tab
Switches pages by clicking this item.</p> <p>2 [Status]
The status of the projector is displayed by clicking this item.</p> <p>3 [Projector control]
The [Projector control] page is displayed by clicking this item.</p> | <p>4 [Detailed set up]
The [Detailed set up] page is displayed by clicking this item.</p> <p>5 [Change password]
The [Change password] page is displayed by clicking this item.</p> <p>6 [CRESTRON RoomView]
The control page of RoomView is displayed by clicking this item.</p> |
|--|--|

[Projector status] page

Click [Status] → [Projector status].

Display the status of the projector for the following items.

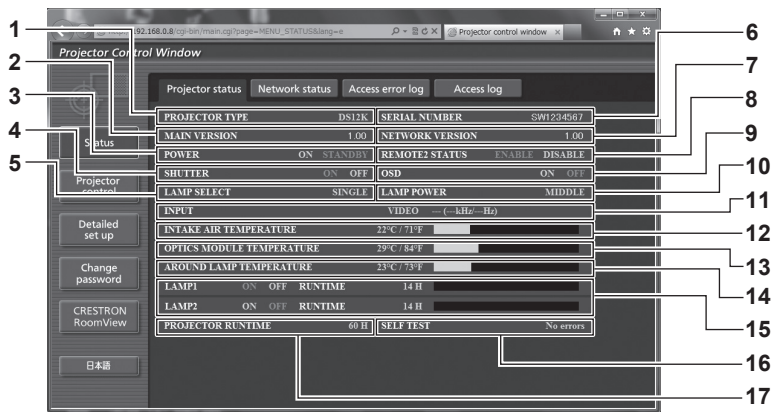

- | | |
|--|--|
| <p>1 [PROJECTOR TYPE]
Displays the type of the projector.</p> <p>2 [MAIN VERSION]
Displays the firmware version of the projector.</p> <p>3 [POWER]
Displays the status of the power.</p> <p>4 [SHUTTER]
Displays the status of the shutter (ON: closed, OFF: open).</p> <p>5 [LAMP SELECT]
Displays the setting status of [LAMP SELECT] (➡ page 109).</p> <p>6 [SERIAL NUMBER]
Displays the serial number of the projector.</p> <p>7 [NETWORK VERSION]
Displays the version of the firmware of the network.</p> <p>8 [REMOTE2 STATUS]
Displays the control status of the <REMOTE 2 IN> terminal.</p> <p>9 [OSD]
Displays the status of the on-screen display.</p> | <p>10 [LAMP POWER]
Displays the setting status of [LAMP POWER] (➡ page 111).</p> <p>11 [INPUT]
Displays the status of the selected input.</p> <p>12 [INTAKE AIR TEMPERATURE]
Displays the status of the air intake temperature of the projector.</p> <p>13 [OPTICS MODULE TEMPERATURE]
Displays the status of the internal temperature of the projector.</p> <p>14 [AROUND LAMP TEMPERATURE]
Displays the status of the temperature around the lamp of the projector.</p> <p>15 [LAMP1][LAMP2][RUNTIME]
Displays the status and the runtime (converted value) of the lamp.</p> <p>16 [SELF TEST]
Displays the self-diagnosis information.</p> <p>17 [PROJECTOR RUNTIME]
Displays the runtime of the projector.</p> |
|--|--|

Error information page

When [Error (Detail)] or [Warning (Detail)] is displayed in the self-diagnosis display of the [Projector status] screen, click it to display the error/warning details.

- The projector may go into the standby status to protect the projector depending on the contents of the error.



1

1 Self-diagnosis result display

Displays the item check results.

[OK]:

Indicates that operation is normal.

[FAILED]:

Indicates that there is a problem.

[WARNING]:

Indicates that there is a warning.

■ [FAILED] items displayed when a problem occurs

Parameter	Description
[MAIN CPU BUS]	There is a problem with the microcomputer circuitry. Consult your dealer.
[FAN]	There is a problem with the fan or the fan drive circuit. Consult your dealer.
[INTAKE AIR TEMPERATURE]	The air intake temperature is too high. The projector may be used in an operating environment where the temperature is high, such as near a heating appliance.
[OPTICS MODULE TEMPERATURE]	The temperature around the optics module inside the projector is high. The projector may be used in an operating environment where the temperature is high, such as near a heating appliance.
[AROUND LAMP TEMPERATURE]	The temperature around the lamp is high. The air exhaust port may be blocked.
[LAMP1 REMAIN TIME]	The runtime of the lamp has exceeded the specified time, and it is time to replace the lamp.
[LAMP2 REMAIN TIME]	
[LAMP1 STATUS]	The lamp has failed to turn on. Wait a while until the luminous lamp cools off, and then turn on the power.
[LAMP2 STATUS]	
[APERTURE(CONTRAST-SHUTTER)]	There is a problem in the contrast shutter circuit for dynamic iris. Consult your dealer.
[INTAKE AIR TEMP.SENSOR]	There is a problem with the sensor used to detect intake temperature. Consult your dealer.
[OPTICS MODULE TEMP.SENSOR]	There is a problem with the sensor used to detect temperature inside the projector. Consult your dealer.
[AROUND LAMP TEMP. SENSOR]	There is a problem with the sensor used to detect exhaust air temperature. Consult your dealer.
[BATTERY]	Battery replacement is required. Consult your dealer.
[LENS MOUNTER]	There is a problem in the lens mounter. Consult your dealer.
[COVER OPEN]	Installation of the lamp unit cover is incomplete. Check the installation of the lamp unit cover. (➡ page 162)
[BRIGHTNESS SENSOR]	There is a problem with the luminance sensor. If problems persist even after switching on the power, consult your dealer.
[ANGLE SENSOR]	There is a problem with the sensor that detects angle. Consult your dealer.
[FILTER UNIT]	The air filter unit is not attached. Check the connection of the air filter unit. (➡ page 158)
[AIR FILTER]	There is too much dust accumulated in the air filter unit. Turn the <MAIN POWER> switch <OFF> (➡ page 55), and clean the air filter. (➡ page 158)
[AC POWER]	AC input voltage is weak. Use electric wiring that can sufficiently withstand the power consumption of the projector.

[Network status] page

Click [Status] → [Network status].

The current network setting status is displayed.

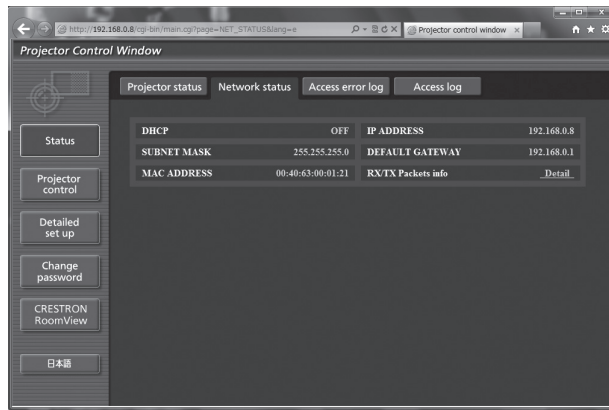

[Access error log] page

Click [Status] → [Access error log].

The error log on the web server is displayed such as access to the pages that do not exist or access with unauthorized user names or passwords.

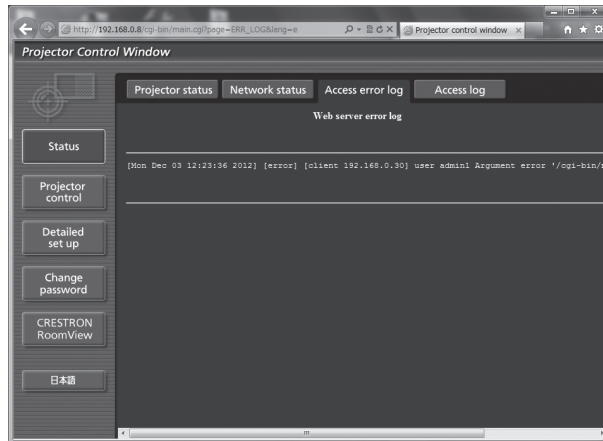

[Access log] page

Click [Status] → [Access log].

The log such as user name accessed to the WEB control page, accessed IP address, accessed time is displayed.

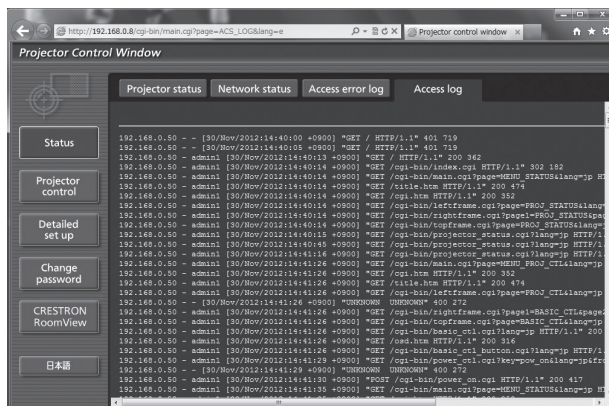

Note

- [Access error log]/[Access log] will display the recent few thousand accesses/requests. All information may not be displayed when many accesses/requests are made at one time.
- When [Access error log]/[Access log] exceeds a certain amount, old information will be deleted.
- Check [Access error log]/[Access log] periodically.

[Basic control] page

Click [Projector control] → [Basic control].

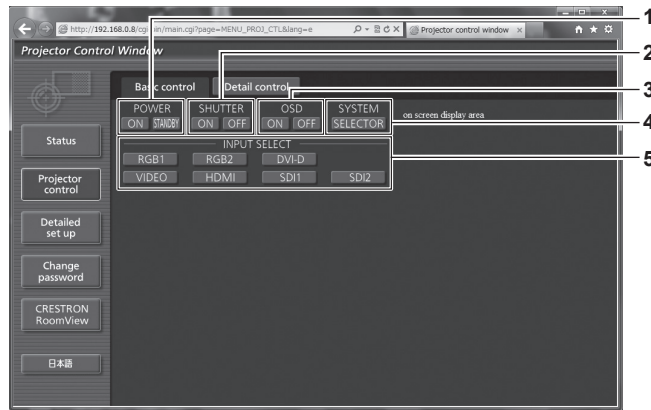

- | | |
|--|---|
| <p>1 [POWER]
Turns on/off the power.</p> <p>2 [SHUTTER]
Switches the setting whether to use the shutter function (closing/opening of the shutter).</p> | <p>3 [OSD]
Switches on (display)/off (hide) the on-screen display function.</p> <p>4 [SYSTEM]
Switches the system method.</p> <p>5 [INPUT SELECT]
Switches the input signal.</p> |
|--|---|

[Detail control] page

Click [Projector control] → [Detail control].

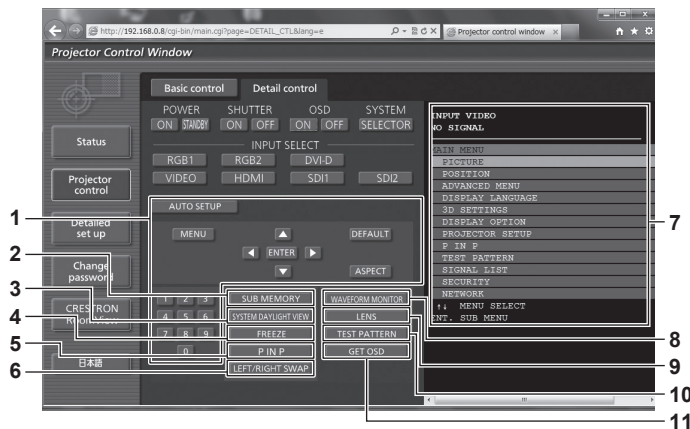

- | | |
|--|---|
| <p>1 Control of the projector
The projector is controlled by clicking the buttons in the same way as the buttons on the remote control. After control, the on-screen display of the projector at the right of the control page is updated.</p> <p>2 [SUB MEMORY]
Switches the sub memory.</p> <p>3 [SYSTEM DAYLIGHT VIEW]
Switches to system daylight view settings.</p> <p>4 [FREEZE]
Temporarily pauses the image.</p> <p>5 [P IN P]
Switches the P IN P setting.</p> <p>6 [LEFT/RIGHT SWAP] (only for PT-DZ13KE, PT-DS12KE, PT-DW11KE)
Switches the flip horizontal settings.</p> | <p>7 On-screen display of the projector
Displays the same items as shown on the on-screen display of the projector. You can check or change the settings of the menus. It is displayed even if the on-screen display function is set to off (hide).</p> <p>8 [WAVEFORM MONITOR]
Displays the waveform of the input signal.</p> <p>9 [LENS]
Adjusts the projection lens.</p> <p>10 [TEST PATTERN]
Displays the test pattern.</p> <p>11 [GET OSD]
Updates the on-screen display of the projector at the right of the control page.</p> |
|--|---|

[Network config] page

Click [Detailed set up] → [Network config].

- Click [Network config] to display the **[CAUTION!]** screen.
- The current settings are displayed by pressing the [Next] button.
- Click [Change] to display the setting change screen.

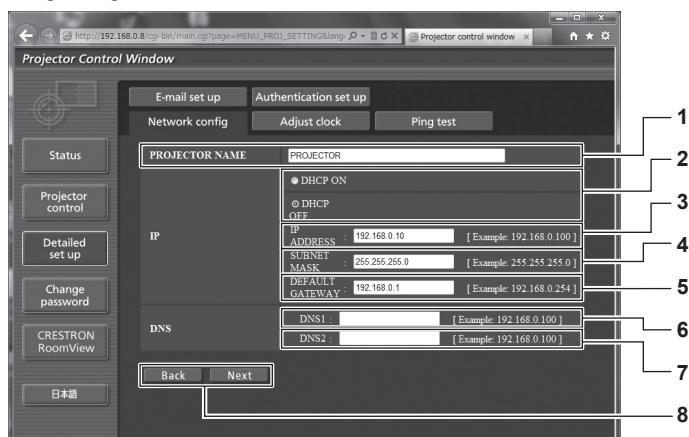

- [PROJECTOR NAME]**
Enter the name of the projector. Enter the host name if it is required when using a DHCP server etc.
- [DHCP ON]/[DHCP OFF]**
To enable the DHCP client function, set to [DHCP ON].
- [IP ADDRESS]**
Enter the IP address when not using a DHCP server.
- [SUBNET MASK]**
Enter the subnet mask when not using a DHCP server.
- [DEFAULT GATEWAY]**
Enter the default gateway address when not using a DHCP server.
- [DNS1]**
Enter the DNS1 server address.
Permissible characters for the entry of DNS1 server address (primary):
Numbers (0 - 9), period (.)
(Example: 192.168.0.253)
- [DNS2]**
Enter the DNS2 server address.
Available characters for the entry of DNS2 server address (secondary):
Numbers (0 - 9), period (.)
(Example: 192.168.0.254)
- [Back]/[Next]**
Click the [Back] button to return to the original screen. The current settings are displayed by pressing the [Next] button. Click the [Submit] button to update the settings.

Note

- When you use the “Forward” and “Back” functions of your browser, a warning message “Page has Expired” may appear. In that case, click [Network config] again since the following operation will not be guaranteed.
- Changing LAN settings while connected to the LAN may cause the connection to cut out.

[Adjust clock] page

Click [Detailed set up] → [Adjust clock].

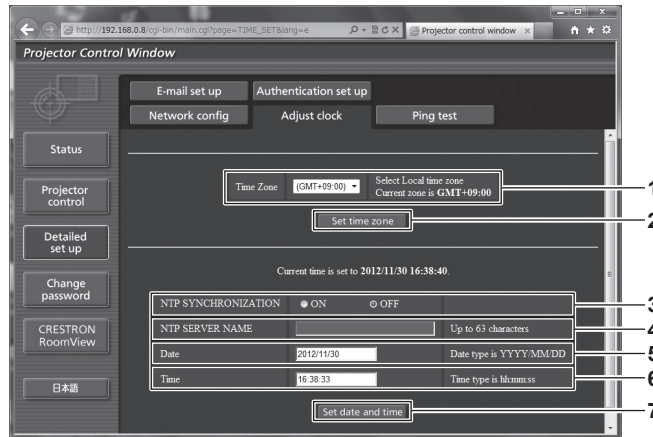

- | | |
|---|---|
| <p>1 [Time Zone]
Select the time zone.</p> <p>2 [Set time zone]
Updates the time zone setting.</p> <p>3 [NTP SYNCHRONIZATION]
Set to [ON] to adjust the date and time automatically.</p> <p>4 [NTP SERVER NAME]
Enter the IP address or server name of the NTP server when you set to adjust the date and time manually.
(To enter the server name, the DNS server needs to be set up.)</p> | <p>5 [Date]
Enter the date to be changed.</p> <p>6 [Time]
Enter the time to be changed.</p> <p>7 [Set date and time]
Updates the date and time settings.</p> |
|---|---|

Note

- The replacement of the battery inside the projector is required when the time goes out of alignment right after correcting the time. Consult your dealer.

[Ping test] page

Check whether the network is connected to the mail server, POP server, DNS server, etc.

Click [Detailed set up] → [Ping test].

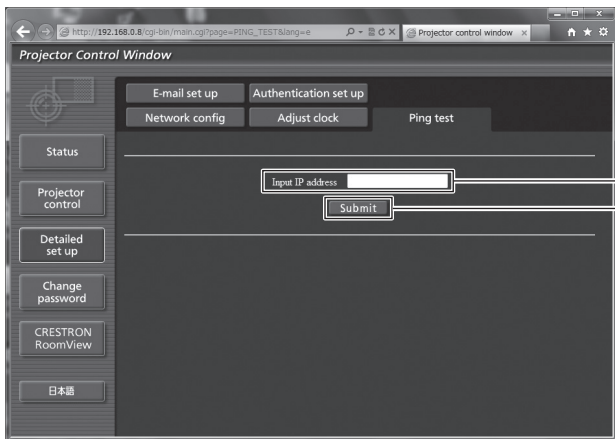

```

PING 192.168.10.218 (192.168.10.218): 56 data bytes
64 bytes from 192.168.10.218: seq=0 ttl=128 time=1.228 ms
64 bytes from 192.168.10.218: seq=1 ttl=128 time=0.942 ms
64 bytes from 192.168.10.218: seq=2 ttl=128 time=0.854 ms
64 bytes from 192.168.10.218: seq=3 ttl=128 time=0.962 ms

--- 192.168.10.218 ping statistics ---
4 packets transmitted, 4 packets received, 0% packet loss
round-trip min/avg/max = 0.854/0.996/1.228 ms
    
```

```

PING 192.168.10.217 (192.168.10.217): 56 data bytes

--- 192.168.10.217 ping statistics ---
4 packets transmitted, 0 packets received, 100% packet loss
    
```

- | | |
|--|--|
| <p>1 [Input IP address]
Enter the IP address of the server to be tested.</p> <p>2 [Submit]
Executes the connection test.</p> | <p>3 Example of display when the connection has succeeded</p> <p>4 Example of display when the connection has failed</p> |
|--|--|

[E-mail set up] page

When there is a problem or the runtime of a lamp reaches a set value, an E-mail can be sent to preset E-mail addresses (up to two addresses).

Click [Detailed set up] → [E-mail set up].

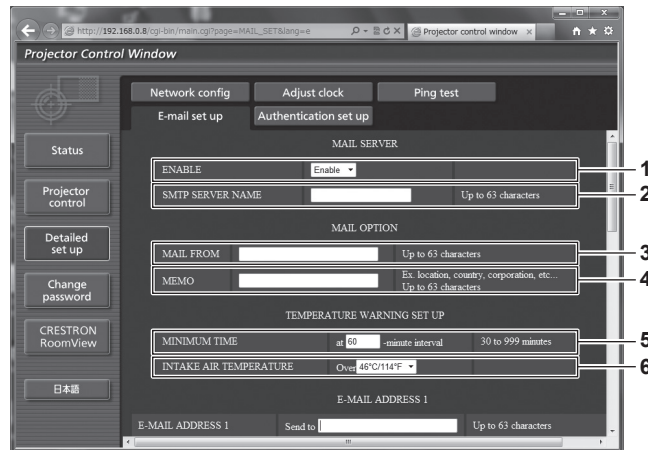

- | | |
|---|---|
| <p>1 [ENABLE]
Select [Enable] to use the E-mail function.</p> <p>2 [SMTP SERVER NAME]
Enter the IP address or the server name of the E-mail server (SMTP). To enter the server name, the DNS server needs to be set up.</p> <p>3 [MAIL FROM]
Enter the E-mail address of the projector. (Up to 63 characters in single byte)</p> <p>4 [MEMO]
Enter information such as the location of the projector that notifies the sender of the E-mail. (Up to 63 characters in single byte)</p> | <p>5 [MINIMUM TIME]
Change the minimum interval for the temperature warning E-mail. The default value is 60 minutes. In this case, another E-mail will not be sent for 60 minutes after sending the temperature warning E-mail even if it reaches the warning temperature.</p> <p>6 [INTAKE AIR TEMPERATURE]
Change the temperature setting for the temperature warning mail. A temperature warning E-mail is sent when the temperature exceeds this value.</p> |
|---|---|

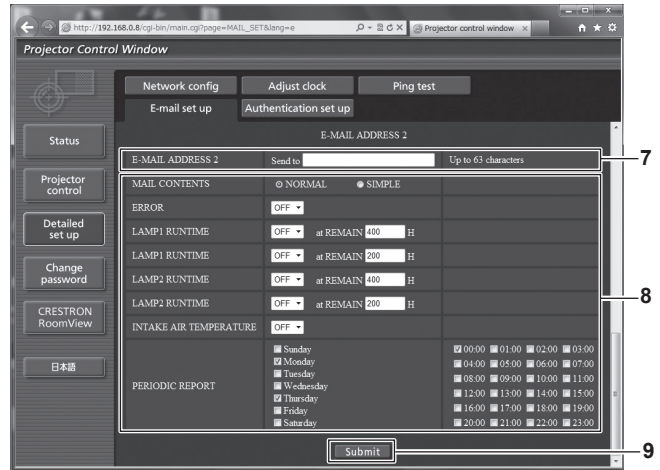
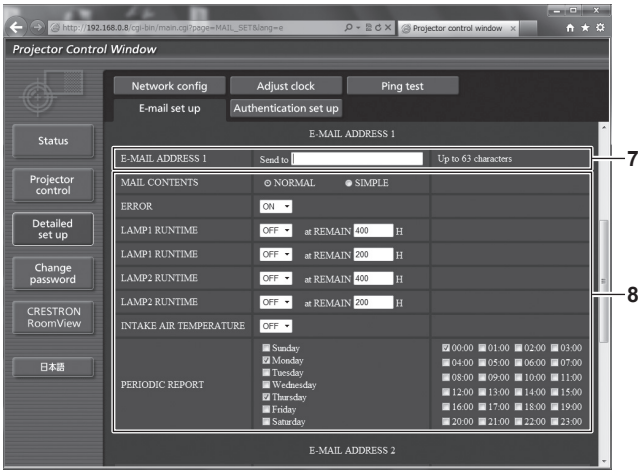

7 **[E-MAIL ADDRESS 1], [E-MAIL ADDRESS 2]**
Enter the E-mail address to be sent. Leave [E-MAIL ADDRESS 2] blank when two E-mail addresses are not to be used.

8 **Settings of the conditions to send E-mail**
Select the conditions to send E-mail.
[MAIL CONTENTS]:
Select either [NORMAL] or [SIMPLE].
[ERROR]:
Send an E-mail when an error occurred in the self-diagnosis.
[LAMP1 RUNTIME]:
An E-mail message is sent when the remaining lamp on time for the lamp 1 has reached the value set at the right field.
[LAMP2 RUNTIME]:
An E-mail message is sent when the remaining lamp on time for the lamp 2 has reached the value set at the right field.
[INTAKE AIR TEMPERATURE]:
Send an E-mail when the air intake temperature has reached the value set at the above field.
[PERIODIC REPORT]:
Place a check mark on this to send an E-mail periodically. It will be sent on the days and time with the check mark.

9 **[Submit]**
Update the settings.

Note

- Set each item of [LAMP1 RUNTIME] to [LAMP2 RUNTIME] to 500 hours or less when using the optional Replacement lamp unit (for portrait mode) (Model No.: ET-LAD320P (1 pc), ET-LAD320PW (2 pcs)).

[Authentication set up] page

Set the authentication items when POP authentication or SMTP authentication is necessary to send an E-mail.
Click [Detailed set up] → [Authentication set up].

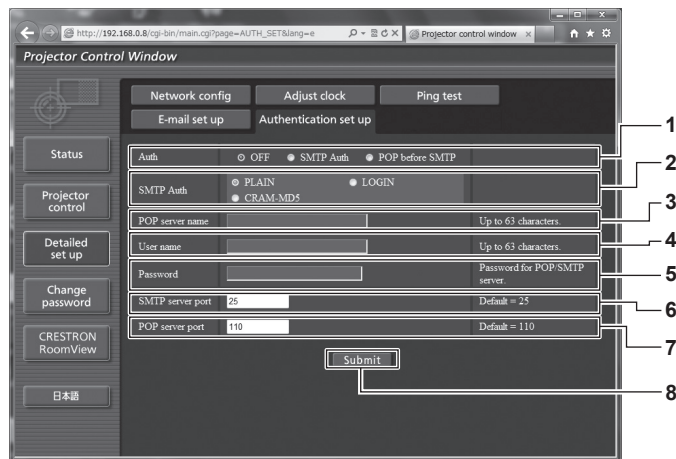

- | | |
|--|---|
| <p>1 [Auth]
Select the authentication method specified by your Internet service provider.</p> <p>2 [SMTP Auth]
Set when the SMTP authentication is selected.</p> <p>3 [POP server name]
Enter the POP server name.
Allowed characters:
Alphanumerics (A - Z, a - z, 0 - 9)
Minus sign (-) and period (.)</p> <p>4 [User name]
Enter the user name for the POP server or the SMTP server.</p> | <p>5 [Password]
Enter the password for the POP server or the SMTP server.</p> <p>6 [SMTP server port]
Enter the port number of the SMTP server.
(Normally 25)</p> <p>7 [POP server port]
Enter the port number of the POP server.
(Normally 110)</p> <p>8 [Submit]
Update the settings.</p> |
|--|---|

Contents of E-mail sent

Example of E-mail sent when E-mail is set

The following E-mail is sent when the E-mail settings have been established.

```

=== Panasonic projector report(CONFIGURE) ===
Projector Type   : DS12K
Serial No       : SW1234567

---- E-mail setup data ----
TEMPERATURE WARNING SETUP
MINIMUM TIME    at [ 60] minutes interval
INTAKE AIR TEMPERATURE      Over [ 46degC / 114degF ]

ERROR          [ OFF ]
LAMP1 RUNTIME  [ OFF ] at REMAIN [ 400] H
LAMP2 RUNTIME  [ OFF ] at REMAIN [ 200] H
LAMP1 RUNTIME  [ OFF ] at REMAIN [ 400] H
LAMP2 RUNTIME  [ OFF ] at REMAIN [ 200] H
INTAKE AIR TEMPERATURE      [ OFF ]
PERIODIC REPORT
Sunday [ OFF ] Monday [ ON ] Tuesday [ OFF ] Wednesday [ OFF ]
Thursday [ ON ] Friday [ OFF ] Saturday [ OFF ]

00:00 [ ON ] 01:00 [ OFF ] 02:00 [ OFF ] 03:00 [ OFF ]
04:00 [ OFF ] 05:00 [ OFF ] 06:00 [ OFF ] 07:00 [ OFF ]
08:00 [ OFF ] 09:00 [ OFF ] 10:00 [ OFF ] 11:00 [ OFF ]
12:00 [ OFF ] 13:00 [ OFF ] 14:00 [ OFF ] 15:00 [ OFF ]
16:00 [ OFF ] 17:00 [ OFF ] 18:00 [ OFF ] 19:00 [ OFF ]
20:00 [ OFF ] 21:00 [ OFF ] 22:00 [ OFF ] 23:00 [ OFF ]

---- check system ----
MAIN CPU BUS           [ OK ]
FAN                    [ OK ]
INTAKE AIR TEMPERATURE [ OK ]
OPTICS MODULE TEMPERATURE [ OK ]
AROUND LAMP TEMPERATURE [ OK ]
LAMP1 REMAIN TIME      [ OK ]
LAMP2 REMAIN TIME      [ OK ]
LAMP1 STATUS           [ OK ]
LAMP2 STATUS           [ OK ]
APERTURE(CONTRAST-SHUTTER) [ OK ]
INTAKE AIR TEMP.SENSOR [ OK ]
OPTICS MODULE TEMP.SENSOR [ OK ]
AROUND LAMP TEMP.SENSOR [ OK ]
BATTERY                [ OK ]
LENS MOUNTER           [ OK ]
COVER OPEN             [ OK ]
BRIGHTNESS SENSOR     [ OK ]
ANGLE SENSOR           [ OK ]
FILTER UNIT            [ OK ]
AIR FILTER              [ OK ]
AC POWER               [ OK ]
(Error code 00 00 00 00 00 00 00 00 00 00 00 00 00 00 00)

Intake air temperature : 27 degC / 80 degF
Optics module temperature : 33 degC / 91 degF
Around lamp temperature : 32 degC / 89 degF
PROJECTOR RUNTIME      200 H
POWER ON                1 times
LAMP1 ON                1 times
LAMP1 LOW               200 H
LAMP1 MID               0 H
LAMP1 HIGH              0 H
LAMP1 REMAIN            1800 H
LAMP2 ON                1 times
LAMP2 LOW               200 H
LAMP2 MID               0 H
LAMP2 HIGH              0 H
LAMP2 REMAIN            1800 H

----- Current status -----
MAIN VERSION            1.00
NETWORK VERSION         1.00
SUB VERSION             1.00
LAMP STATUS             LAMP1=ON LAMP2=ON
INPUT                   RGB1
REMOTE2 STATUS          DISABLE

---- Wired Network configuration ----
DHCP Client             OFF
IP address              192.168.0.8
MAC address             70:85:12:00:00:00

Fri Nov 01 16:38:50 2013

---- Memo ----

```

Example of the E-mail sent for an error

The following E-mail is sent when an error has occurred.

```

=== Panasonic projector report(ERROR) ===
Projector Type   : DS12K
Serial No       : SW1234567

----- check system -----
MAIN CPU BUS    [ OK ]
FAN             [ OK ]
INTAKE AIR TEMPERATURE [ OK ]
OPTICS MODULE TEMPERATURE [ OK ]
AROUND LAMP TEMPERATURE [ OK ]
LAMP1 REMAIN TIME [ OK ]
LAMP2 REMAIN TIME [ OK ]
LAMP1 STATUS   [ FAILED ]
LAMP2 STATUS   [ FAILED ]
APERTURE(CONTRAST-SHUTTER) [ OK ]
INTAKE AIR TEMP.SENSOR [ OK ]
OPTICS MODULE TEMP.SENSOR [ OK ]
AROUND LAMP TEMP.SENSOR [ OK ]
BATTERY        [ OK ]
LENS MOUNTER   [ OK ]
COVER OPEN     [ FAILED ]
BRIGHTNESS SENSOR [ OK ]
ANGLE SENSOR   [ OK ]
FILTER UNIT    [ OK ]
AIR FILTER     [ OK ]
AC POWER       [ OK ]
(Error code 00 00 00 60 00 00 00 00 00 00 00 23 00 00 00)

Intake air temperature : 27 degC / 80 degF
Optics module temperature : 33 degC / 91 degF
Around lamp temperature : 32 degC / 89 degF
PROJECTOR RUNTIME      200 H
POWER ON               1 times
LAMP1 ON               1 times
LAMP1 LOW              200 H
LAMP1 MID              0 H
LAMP1 HIGH             0 H
LAMP1 REMAIN           1800 H
LAMP2 ON               1 times
LAMP2 LOW              200 H
LAMP2 MID              0 H
LAMP2 HIGH             0 H
LAMP2 REMAIN           1800 H

----- Current status -----
MAIN VERSION          1.00
NETWORK VERSION       1.00
SUB VERSION           1.00
LAMP STATUS           LAMP1=ON LAMP2=ON
INPUT                 RGB1
REMOTE2 STATUS        DISABLE

----- Wired Network configuration -----
DHCP Client           OFF
IP address            192.168.0.8
MAC address           70:85:12:00:00:00

Fri Nov 01 16:50:14 2013

----- Memo -----

```

[Change password] page

Click [Change password].

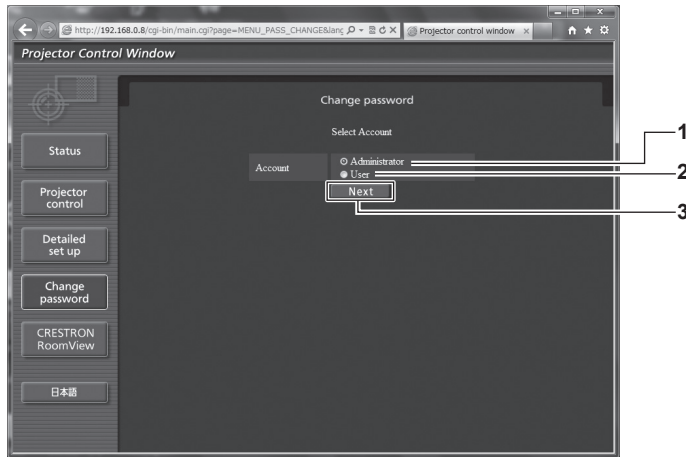

- 1 **[Administrator]**
Used to change the setting of the [Administrator].
- 2 **[User]**
Used to change the setting of the [User].
- 3 **[Next]**
Used to change the setting of the password.

[Administrator] account

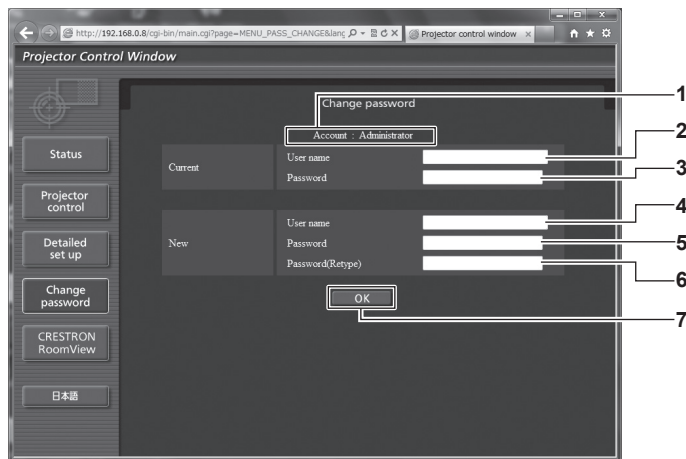

- 1 **[Account]**
Displays the account to change.
- 2 **[Current][User name]**
Enter the user name before the change.
- 3 **[Current][Password]**
Enter the current password.
- 4 **[New][User name]**
Enter the desired new user name. (Up to 16 characters in single byte)
- 5 **[New][Password]**
Enter the desired new password. (Up to 16 characters in single byte)
- 6 **[New][Password(Retype)]**
Enter the desired new password again.
- 7 **[OK]**
Determines the change of password.

[User] account

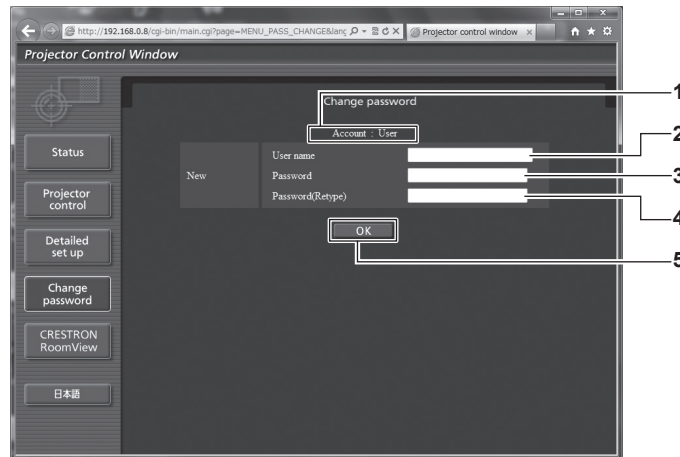

- | | |
|--|---|
| <p>1 [Account]
Displays the account to change.</p> <p>2 [New][User name]
Enter the desired new user name. (Up to 16 characters in single byte)</p> | <p>3 [New][Password]
Enter the desired new password. (Up to 16 characters in single byte)</p> <p>4 [New][Password(Retyp)]
Enter the desired new password again.</p> <p>5 [OK]
Determines the change of password.</p> |
|--|---|

[Change password] (For user rights)

Only the change of password is enabled under the user rights.

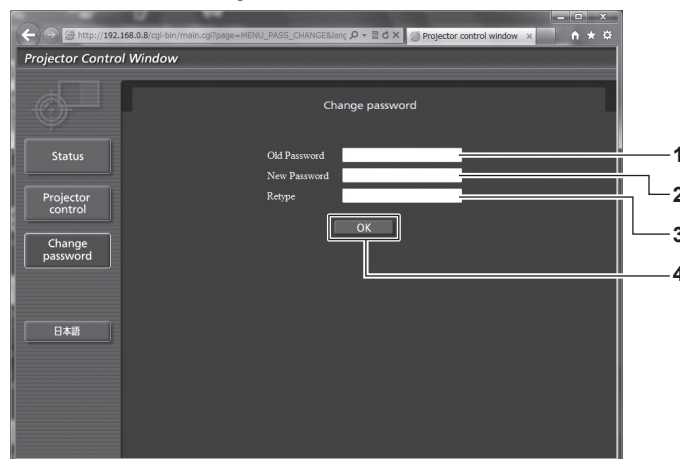

- | | |
|--|--|
| <p>1 [Old Password]
Enter the current password.</p> <p>2 [New Password]
Enter the desired new password. (Up to 16 characters in single byte)</p> | <p>3 [Retype]
Enter the desired new password again.</p> <p>4 [OK]
Determines the change of password.</p> |
|--|--|

Note

- To change the account of the administrator, you must enter the [User name] and [Password] in [Current].

[CRESTRON RoomView] page

The projector can be monitored/controlled with RoomView.

To start the RoomView control page from the web control screen, you need to access with the administrator rights. (For user rights, the [CRESTRON RoomView] button is not displayed on the web control screen.)

The control page of RoomView is displayed by clicking [CRESTRON RoomView].

It is not displayed if Adobe Flash Player is not installed on the computer used, or the browser used does not support Flash. In that case, click [Back] on the control page to go back to the previous page.

Control page

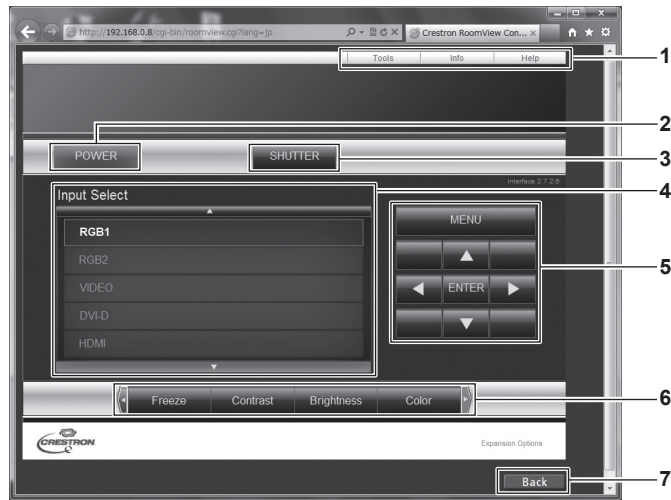

- 1 **[Tools][Info][Help]**
Tabs for selecting the setting, information, or help page of the projector.
- 2 **[POWER]**
Turns on/off the power.
- 3 **[SHUTTER]**
Switches the setting whether to use the shutter function (closing/opening of the shutter).

- 4 **[Input Select]**
Controls input selection.
Not available when the power of the projector is turned off.
- 5 **Menu screen control buttons**
Navigates the menu screen.
- 6 **Freeze/image quality adjustment**
Controls items related to freeze/image quality.
- 7 **[Back]**
Performs return to the previous page.

[Tools] page

Click [Tools] on the control page.

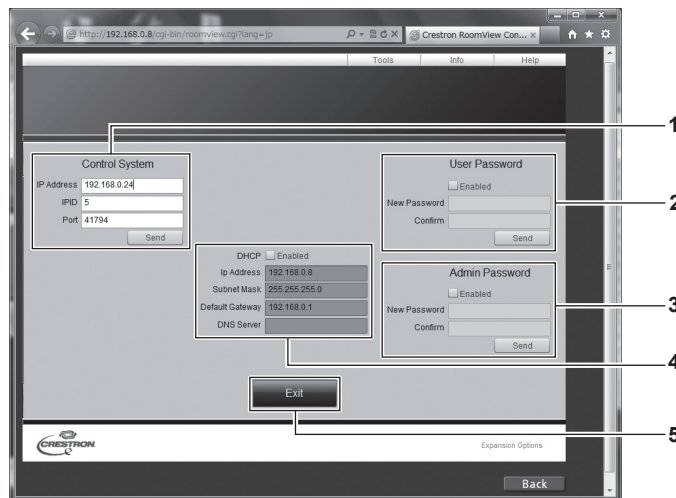

- 1 **[Control System]**
Set the information required for communicating with the controller to be connected with the projector.
- 2 **[User Password]**
Set the user rights password for the RoomView control page.
- 3 **[Admin Password]**
Set the administrator rights password for the RoomView control page.

- 4 **Network status**
Displays the settings of wired LAN.
[DHCP]
Displays the current setting.
[Ip Address]
Displays the current setting.
[Subnet Mask]
Displays the current setting.
[Default Gateway]
Displays the current setting.
[DNS Server]
Displays the current setting.
- 5 **[Exit]**
Returns to the control page.

[Info] page

Click [Info] on the control page.

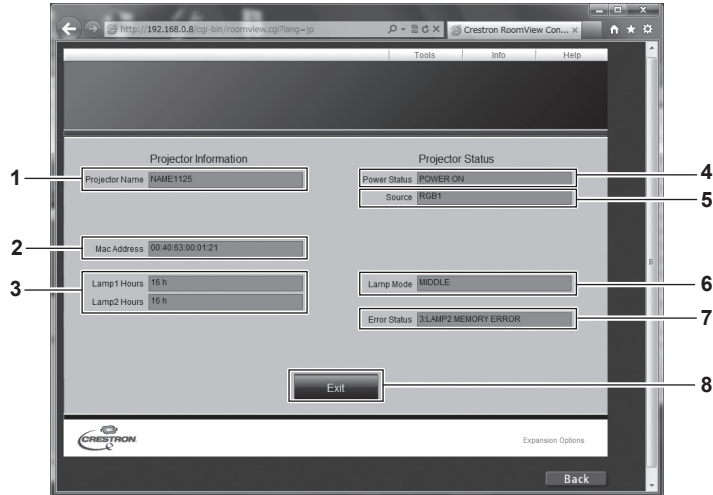

- | | |
|--|---|
| <p>1 [Projector Name]
Displays the projector name.</p> <p>2 [Mac Address]
Displays the MAC address.</p> <p>3 [Lamp Hours]
Displays the runtime of the lamps (converted value).</p> <p>4 [Power Status]
Displays the status of the power.</p> | <p>5 [Source]
Displays the selected input.</p> <p>6 [Lamp Mode]
Displays [LAMP POWER] (► page 111).</p> <p>7 [Error Status]
Displays the error status.</p> <p>8 [Exit]
Returns to the control page.</p> |
|--|---|

[Help] page

Click [Help] on the control page.

The [Help Desk] window is displayed.

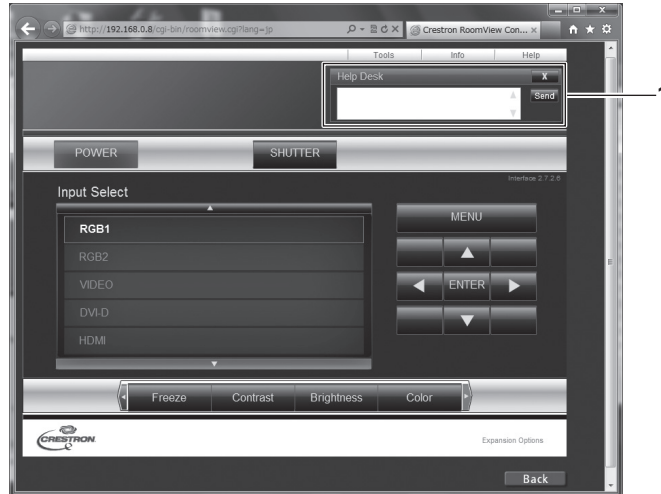

- 1 [Help Desk]**
Send/receive messages to/from an administrator who uses Crestron RoomView.

Chapter 5 Maintenance

This chapter describes methods of inspection when there are problems, maintenance, and replacement of the units.

Lamp/temperature/filter indicators

When an indicator lights up

If a problem should occur inside the projector, the lamp indicators <LAMP1>/<LAMP2>, the temperature indicator <TEMP>, and the filter indicator <FILTER> will inform you by lighting or flashing. Check the status of the indicators and manage the indicated problems as follows.

Attention

- When switching off the projector to deal with problems, make sure to follow the procedure in “Switching off the projector” (➔ page 55).

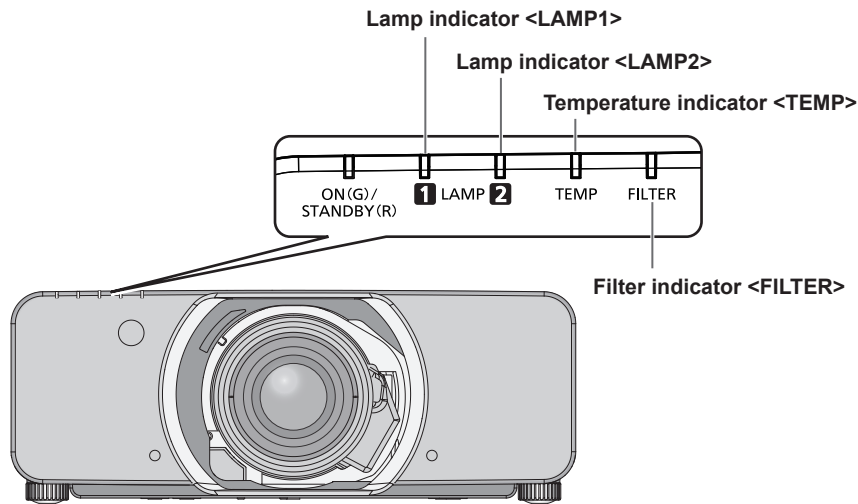

Lamp indicators <LAMP1>/<LAMP2>

Indicator status	Lighting in red/lighting in orange*1	Flashing in red (1 time)	Flashing in red (3 times)	
Status	Time to replace the lamp unit. (➔ page 161)	<ul style="list-style-type: none"> • The lamp unit is not installed. • The unspecified lamp unit is installed. 	A problem is detected in the lamp or the power supply for the lamp.	
Cause	<ul style="list-style-type: none"> • Was [REPLACE LAMP] displayed when you turned on the power? • The indicator lights up when the runtime of the lamp unit has reached 2 300 hours (when [LAMP POWER] is set to [HIGH])*2 *3. 	<ul style="list-style-type: none"> • Is the specified lamp unit installed? 	<ul style="list-style-type: none"> • Have you turned on the power again immediately after turning it off? 	<ul style="list-style-type: none"> • Some error has occurred in the lamp circuit. Check for fluctuation (or drop) in the source voltage.
Solution	<ul style="list-style-type: none"> • Replace the lamp unit. 	<ul style="list-style-type: none"> • Install the lamp unit if it is not installed. • Install the specified lamp unit. • If the indicator is still flashing in red even when having installed the lamp unit, consult your dealer. 	<ul style="list-style-type: none"> • Wait a while until the luminous lamp cools off, and then turn on the power. 	<ul style="list-style-type: none"> • Turn the <MAIN POWER> switch to <OFF> (➔ page 55), and consult your dealer.

*1 The indicator lights up in red while the lamp is turned off, and lights up in orange while the lamp is turned on.

*2 For PT-DZ13KE, PT-DS12KE, PT-DW11KE. 3 300 hours (when [LAMP POWER] is set to [NORMAL]) for PT-DZ10KE.

*3 300 hours when using the optional Replacement lamp unit (for portrait mode) (Model No.: ET-LAD320P (1 pc), ET-LAD320PW (2 pcs)) (when [LAMP POWER] is set to [MIDDLE] or [NORMAL]).

Note

- If the lamp indicators <LAMP1>/<LAMP2> are still lit or flashing after taking the preceding measures, ask your dealer for repair.

Temperature indicator <TEMP>

Indicator status	Lighting in red		Flashing in red (2 times)	Flashing in red (3 times)
Status	Warm-up status	Internal temperature is high (warning).	Internal temperature is high (standby status).	The cooling fan has stopped.
Cause	<ul style="list-style-type: none"> Did you turn on the power when the temperature was low (around 0 °C (32 °F))? 	<ul style="list-style-type: none"> Is the air intake/exhaust port blocked? Is the room temperature high? Is the filter indicator <FILTER> lit? 		—
Solution	<ul style="list-style-type: none"> Wait at least five minutes in the current status. Install the projector in a location with an ambient temperature of 0 °C (32 °F) to 45 °C (113 °F)*1. 	<ul style="list-style-type: none"> Remove any objects that are blocking the air intake/exhaust port. Install the projector in a location with an ambient temperature of 0 °C (32 °F) to 45 °C (113 °F)*1. Do not use the projector at high altitudes of 2 700 m (8 858') or higher above sea level. Clean or replace the air filter unit. (➔ page 158) 		<ul style="list-style-type: none"> Turn the <MAIN POWER> switch to <OFF> (➔ page 55), and consult your dealer.

*1 When using the projector at high altitudes (1 400 m (4 593') or higher – lower than 2 700 m (8 858') above sea level), the operating environment temperature should be between 0 °C (32 °F) and 40 °C (104 °F).
 If you use the Smoke cut filter, the operating environment temperature should be between 0 °C (32 °F) and 35 °C (95 °F). However, it cannot be used at high altitudes.
 If you use the Replacement lamp unit (for portrait mode), the operating environment temperature should be between 0 °C (32 °F) and 40 °C (104 °F) when using the projector at elevations lower than 1 400 m (4 593') above sea level, and between 0 °C (32 °F) and 35 °C (95 °F) when using the projector at high altitudes. If you use the Smoke cut filter together, the operating environment temperature should be between 0 °C (32 °F) and 30 °C (86 °F).

Note

- If the temperature indicator <TEMP> is still lit or flashing after taking the preceding measures, ask your dealer for repair.
- If the [PROJECTOR SETUP] menu → [LAMP POWER] is set to [HIGH], [MIDDLE], or [NORMAL], and an ambient temperature reaches 40 °C (104 °F) or higher (35 °C (95 °F) or higher when [HIGH ALTITUDE MODE] is set to [ON] or the Smoke cut filter is used), the light output may decrease by approx. 20 % to protect the projector.

Filter indicator <FILTER>

Indicator status	Lighting in red			Flashing in red
Status	The filter is clogged. The temperature inside or outside the projector is abnormally high.			The air filter unit is not attached.
Cause	<ul style="list-style-type: none"> Is the air filter unit dirty? 	<ul style="list-style-type: none"> Is the air intake/exhaust port blocked? 	<ul style="list-style-type: none"> Is [HIGH ALTITUDE MODE] set correctly? 	<ul style="list-style-type: none"> Is the air filter unit attached?
Solution	<ul style="list-style-type: none"> Clean or replace the air filter unit. (➔ page 158) 	<ul style="list-style-type: none"> Remove any objects that are blocking the air intake/exhaust port. 	<ul style="list-style-type: none"> When using the projector at high altitudes between 1 400 m (4 593') or higher and lower than 2 700 m (8 858') above sea level, set [HIGH ALTITUDE MODE] (➔ page 109) to [ON]. Do not use the projector at high altitudes of 2 700 m (8 858') or higher above sea level. 	<ul style="list-style-type: none"> Attach the air filter unit.

Note

- If the filter indicator <FILTER> is still lit or flashing after taking the preceding measures, ask your dealer for repair.
- If the filter is clogged, only one lamp may light even when [LAMP SELECT] is set to [DUAL]. By cleaning the air filter unit or replacing it with a new one, the lamp will light properly.

Maintenance/replacement

Before performing maintenance/replacement

- Make sure to turn off the power before maintaining or replacing the unit. (► pages 52, 55)
- When switching off the projector, make sure to follow the procedures in “Switching off the projector” (► page 55).

Maintenance

Outer case

Wipe off dirt and dust with a soft, dry cloth.

- If the dirt is persistent, soak the cloth with water and wring it thoroughly before wiping. Dry off the projector with a dry cloth.
- Do not use benzene, thinner, or rubbing alcohol, other solvents, or household cleaners. Doing so may deteriorate the outer case.
- When using chemically treated dust cloths, follow the instructions written on its packaging.

Lens front surface

Wipe off dirt and dust from the front surface of the lens with a soft clean cloth.

- Do not use a cloth that is fluffy, dusty, or soaked with oil/water.
- Since the lens is fragile, do not use excessive force when wiping the lens.

Attention

- The lens is made of glass. Impacts or excessive force when wiping may scratch its surface. Handle with care.

Air filter unit

Perform maintenance of the air filter unit in the following cases.

- The air filter is clogged with dust, causing the filter replacement message to appear on the screen and the filter indicator <FILTER> to light in red.

Removing the air filter unit

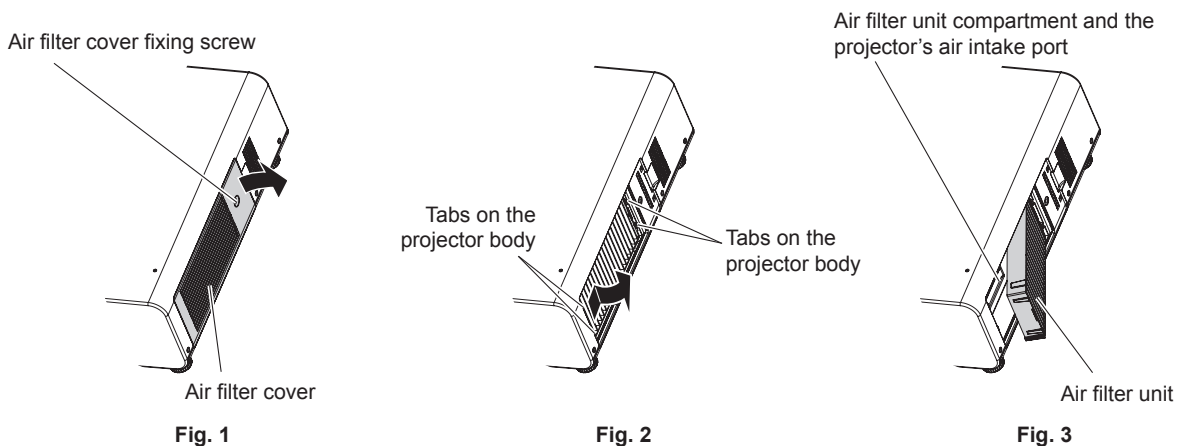

1) Remove the air filter cover. (Fig. 1)

- Use a Phillips screwdriver to turn the air filter cover screw counterclockwise until it turns freely, and then remove the air filter cover.
- Loosen the air filter cover fixing screw while putting your hand on.

2) Pull out the air filter unit.

- Pull out the air filter unit frame from the tabs of the projector body while slightly pressing around the center of the frame at the front side (with the lens) inward as described with the arrow, and pull out the frame at the opposite side from the tabs to remove the air filter unit. (Fig. 2)
- After pulling out the air filter unit, remove large foreign objects and dust from the air filter unit compartment and the air intake port of the projector body if there are any. (Fig. 3)

Cleaning the air filter unit

Remove the air filter unit beforehand with the previously described procedure of “Removing the air filter unit”.

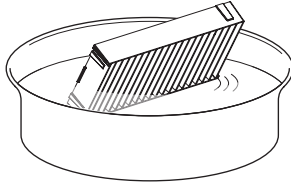

Fig. 1

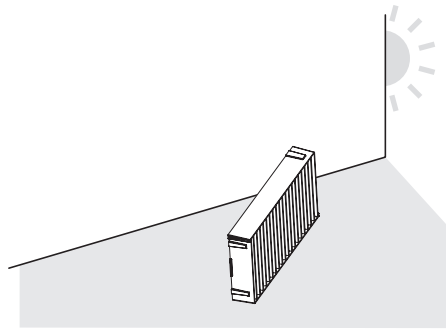

Fig. 2

1) Wash the air filter unit. (Fig. 1)

- i) Soak the air filter unit in cold or warm water and then lightly rinse it.
 - Do not use cleaning tools such as brushes.
 - When rinsing, hold the frame of the air filter unit without putting strong pressure on the filter unit.
- ii) Rinse the air filter unit two to three times using fresh water each time.
 - Insufficient rinsing may result in odors.

2) Dry the air filter unit. (Fig. 2)

- Let the air filter unit naturally dry off in a well-ventilated place where there is little dust and is not exposed to direct sunlight.
- Do not dry using drying devices such as dryers.
- After the air filter is dried, proceed to “Attaching the air filter unit” (➔ page 159).

Attaching the air filter unit

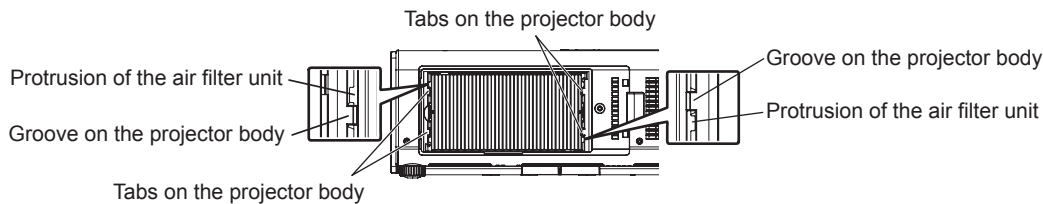

1) Attach the air filter unit to the projector.

- The air filter unit has no difference between top and bottom, but is two-sided. Match the protrusion position of the air filter unit with the grooves on the projector body.
- Hook the air filter unit frame at the exhaust port side to the two tabs of the back side of the projector's air filter unit compartment and perform Step 2) in “Removing the air filter unit” in the reverse order to attach.
- Confirm that the tabs of the air filter unit compartment of the projector body are hooked to the air filter unit frame.

2) Attach the air filter cover to the projector and use a Phillips screwdriver to tighten the air filter cover screw.

- Perform Step 2) in “Removing the air filter unit” (➔ page 158) in the reverse order.

Attention

- After washing the air filter unit, dry it thoroughly before attaching it back to the projector. Attaching a wet unit will cause an electric shock or malfunction.
- Do not disassemble the air filter unit.

Note

- Make sure that the air filter unit is properly attached before using the projector. If it is not properly attached, the projector will suck in dirt and dust causing a malfunction.
- If you use the projector without attaching the air filter unit, the filter indicator <FILTER> flashes in red and the message appears on the projection screen for approximately 30 seconds.
- Replace the air filter unit with the new optional Replacement Filter Unit (Model No.: ET-EMF320) if it is damaged or if the dirt does not come off even after washing.
- Air filter replacement is recommended after cleaning the unit two times.
- The dust-proof properties may be reduced after each cleaning.

Replacing the unit

Air filter unit

If dirt does not come off even after the unit is maintained, it is time for the unit to be replaced.

The Replacement Filter Unit (Model No.: ET-EMF320) is an optional accessory. To purchase the product, consult your dealer.

Replacing the air filter unit

Attention

- Make sure to turn off the power before replacing the air filter unit.
- When attaching the unit, make sure that the projector is stable, and perform the replacement in a safe place where the unit will not be damaged even if you drop the air filter unit.

1) Remove the air filter unit.

- Refer to “Removing the air filter unit” (➡ page 158).

2) Attach the optional Replacement Filter Unit (Model No.: ET-EMF320) to the projector.

- The air filter unit has no difference between top and bottom, but is two-sided. Match the protrusion position of the air filter unit with the grooves on the projector body.
- Refer to “Attaching the air filter unit” (➡ page 159).

Attention

- When switching on the projector, make sure that the air filter unit is attached. If it is not properly attached, the projector will suck in dirt and dust causing a malfunction.
- If you use the projector without attaching the air filter unit, the filter indicator <FILTER> flashes in red and the message appears on the projection screen for approximately 30 seconds.

Note

- The replacement cycle of the air filter unit varies greatly depending on the usage environment.

Lamp unit

The lamp unit is a consumable component. Refer to “When to replace the lamp unit” (➡ page 161) for details about the replacement cycle.

When purchasing the optional Replacement lamp unit (Model No.: ET-LAD310A (1 pc), ET-LAD310AW (2 pcs)) or the Replacement lamp unit (for portrait mode) (Model No.: ET-LAD320P (1 pc), ET-LAD320PW (2 pcs)), consult your dealer.

It is recommended that you request a qualified technician to replace the lamp unit. Consult your dealer.

Warning

Replace the lamp unit after the lamp has cooled (after waiting at least one hour).

The high temperature inside the cover will cause burns.

Checking the lamp unit to be replaced

1) Check the status of the lamp indicators <LAMP1>/<LAMP2>.

- The lamp unit corresponding to the lamp indicator that is lit in red is required to be replaced.

Notes on the replacement of the lamp unit

- A Phillips screwdriver is necessary when replacing the lamp unit.
- Since the luminous lamp is made of glass, it may burst if dropped or hit with a hard object. Handle with care.
- Do not disassemble or modify the lamp unit.
- When replacing the lamp unit, be sure to hold it by the handle because its surface is pointed and its shape is protruded.
- The lamp contains mercury. When disposing of used lamp units, contact your local authorities or dealer for correct methods of disposal.

Attention

- Panasonic takes no responsibility for any damage or malfunction of the product resulting from use of lamp units which are not manufactured by Panasonic. Use only specified lamp units.
- For the portrait setting, be sure to use the optional Replacement lamp unit (for portrait mode).
- Do not use the Replacement lamp unit (for portrait mode) and normal lamp unit together.
- Use the Replacement lamp unit (for portrait mode) only when installing the projector in the portrait setting.

Note

- The model numbers of accessories and optional accessories are subject to change without prior notice.

When to replace the lamp unit

The lamp unit is a consumable component. Since its brightness gradually decreases over time, it is necessary to replace the lamp unit regularly. The estimated duration before replacement is 2 500 hours*1, but the lamp may go off before 2 500 hours*1 has elapsed depending on individual lamp characteristics, usage conditions, and the installation environment. It is recommended that the Replacement lamp unit be prepared earlier.

If you continue to use the lamp unit after 2 500 hours*1 has elapsed, the lamp turns off automatically after approximately 10 minutes, as it will cause malfunction of the projector.

If the runtime of both of two lamp unit bulbs exceeds 2 500 hours*1, the power will be switch off after approximately 10 minutes.

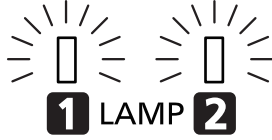
	On-screen display	Lamp indicator
		
Over 2 300 hours*2	The message is displayed for 30 seconds. Pressing any button on the control panel or remote control within 30 seconds will clear the message.	The indicator lights in red even during the standby mode.
Over 2 500 hours*1	The message remains displayed until you press any button.	

*1 For PT-DZ13KE, PT-DS12KE, PT-DW11KE. 3 500 hours for PT-DZ10KE.

*2 For PT-DZ13KE, PT-DS12KE, PT-DW11KE. 3 300 hours for PT-DZ10KE.

Note

- To predict when to replace the lamp, check the lamp runtime displayed in [LAMP1] and [LAMP2] in [STATUS] (➔ page 119).
- 2 500 hours and 3 500 hours are estimated duration before replacement, and is not guaranteed.
- The estimated duration before replacing the Replacement lamp unit (for portrait mode) is 500 hours. The on-screen message for replacing the lamp appears after 300 hours.

How to replace the lamp unit

Attention

- When the projector is mounted on the ceiling, do not conduct work while your face is near the lamp unit.
- Do not remove or loosen the screws other than specified ones when replacing the lamp unit.
- Use same type of lamp unit for both lamps.
- When replacing the lamp unit, loosen the lamp unit cover fixing screw while putting your hand on.

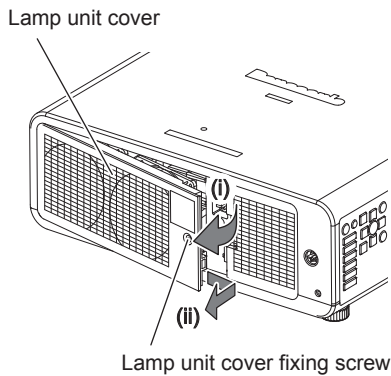
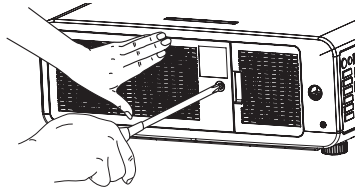

Fig. 1

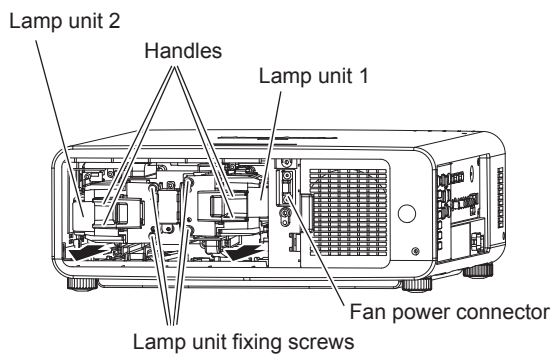

Fig. 2

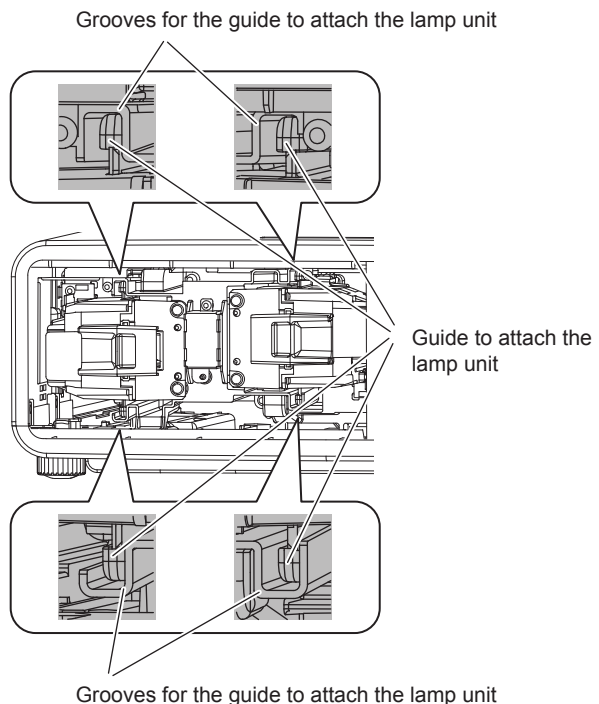

Fig. 3

1) Set the <MAIN POWER> switch to <OFF> and disconnect the power plug from the power outlet.

- Wait at least one hour and check if the lamp unit has cooled down.

2) Remove the lamp unit cover. (Fig. 1)

- Use a Phillips screwdriver to turn the lamp unit cover fixing screw (x1) counterclockwise until it turns freely, and open the lamp unit cover slowly in the direction of the arrow.
 - Opening the lamp unit cover quickly may result in damage to the cover.
 - If you loosen the lamp unit cover fixing screw with the projector installed upward in the vertical direction, the lamp unit cover may open on its weight and the lamp unit may be dropped off.
- Hold the lamp unit cover securely and slide it in the direction of the arrow, and then pull it out backward to remove.
 - Fan and other components are attached to the lamp unit cover; handle the removed lamp unit cover with care.

3) Remove the lamp unit. (Fig. 2)

- Use a Phillips screwdriver to turn the lamp unit fixing screws (x2) counterclockwise until they turn freely, and then remove the lamp unit.
- Hold the handles of the lamp unit and remove it in the horizontal direction.
- Do not remove the screws other than the lamp unit fixing screws.

4) Push in the new lamp unit while paying attention to the insertion position. (Fig. 3)

- Push the guides to attach the lamp unit slowly into the projector body along the grooves for guide to attach the lamp unit.
- If the lamp unit is not installed properly, remove it and then push it in slowly. Pushing it in quickly or forcibly may break the connector.

5) Use a Phillips screwdriver to firmly tighten the lamp unit fixing screws (x2 each).

- Make sure to attach the lamp unit securely.

6) Attach the lamp unit cover.

- i) Close the lamp unit cover in Step 2) in the reverse order.
 - Attach the lamp unit cover so that the connector of the lamp unit cover is inserted to the fan power connector securely.
- ii) Use a Phillips screwdriver to firmly tighten the lamp unit fixing screw (x1).
 - Make sure to attach the lamp unit cover securely.

Note

- When you replace the lamp unit with new one, the projector resets the runtime of the lamp unit automatically.

Troubleshooting

Review the following points. For details, see the corresponding pages.

Problems	Points to be checked	Page
Power does not turn on.	• Is the power plug firmly inserted into the outlet?	—
	• Is the <MAIN POWER> switch set to <OFF>?	55
	• Is the wall outlet supplying electricity?	—
	• Have the circuit breakers tripped?	—
	• Are the lamp indicator <LAMP1>/<LAMP2> or the temperature indicator <TEMP> lit or flashing?	156
	• Is the lamp unit cover attached?	162
No image appears.	• Are connections to external devices correctly performed?	48
	• Is the input selection setting correct?	62
	• Is the [BRIGHTNESS] adjustment setting at a minimum?	72
	• Is the external device that is connected to the projector working properly?	—
	• Is the shutter function in use?	61
	• If the power indicator <ON (G)/STANDBY (R)> is flashing in red, consult your dealer.	—
	• Is the lens cover still attached to the lens?	53
Image is fuzzy.	• Is the lens focus set correctly?	56
	• Is the projection distance appropriate?	32
	• Is the lens dirty?	19
	• Is the projector installed perpendicular to the screen?	—
Color is pale or grayish.	• Is [COLOR] or [TINT] adjusted correctly?	72
	• Is the external device connected to the projector adjusted correctly?	48
	• Is the RGB cable damaged?	—
Remote control does not respond.	• Are the batteries depleted?	—
	• Is the polarity of the batteries set correctly?	28
	• Are there any obstructions between the remote control and the remote control signal receiver of the projector?	24
	• Is the remote control being used beyond its effective operation range?	25
	• Are other forms of light, such as fluorescent light, affecting the projection?	25
	• Is the [REMOTE CONTROL] setting in [CONTROL DEVICE SETUP] set to [DISABLE]?	132
	• Is the <REMOTE 2 IN> terminal used for contact control?	175
	• Is the ID number setting operation correct?	28
Menu screen does not appear.	• Is the on-screen display function turned off (hidden)?	102
Buttons on the control panel do not operate.	• Is the [CONTROL PANEL] setting in [CONTROL DEVICE SETUP] set to [DISABLE]?	132
	• Is the <REMOTE 2 IN> terminal used for contact control?	175
Image does not display correctly.	• Is the [SYSTEM SELECTOR] selection set correctly?	77
	• Is there a problem with the video tape or other image sources?	—
	• Is a signal which is not compatible with the projector being input?	177
Image from a computer does not appear.	• Is the cable too long? (Use D-Sub cables that are 10 m (32'10") or shorter.)	—
	• Is the external video output on the laptop computer set correctly? (Ex.: The external output settings may be switched by pressing the "Fn" + "F3" or "Fn" + "F10" simultaneously. Since the method varies depending on the computer type, refer to the user manual provided with your computer.)	—
Image output from DVI-D of the computer does not appear.	• Is the [DVI-D IN] setting [EDID3]/[EDID2:PC]?	100
	• The graphics accelerator driver of the computer may need to be updated to the latest version.	—
	• The computer may need to be restarted after performing the [DVI-D IN] setting.	100
Video from HDMI compatible device does not appear or it appears jumbled.	• Is the HDMI cable connected securely?	48
	• Turn the power of the projector and the external device off and on.	—
	• Is a signal which is not compatible with the projector being input?	177
Cannot control the projector with Art-Net.	• Is [Art-Net SETUP] set to an item other than [OFF]?	136
	• Are the [NET], [SUB NET], [UNIVERSE], and [START ADDRESS] settings correct?	136

Chapter 5 Maintenance — Troubleshooting

Problems	Points to be checked	Page
3D function is not working.	<ul style="list-style-type: none">• Is the [3D INPUT FORMAT] setting of [3D SETTINGS] correct?• Check the 3D eyewear settings.• Is a signal which is supported by the projector being input?	92 — 179
Left and right images are reversed (not showing properly).	<ul style="list-style-type: none">• Are the devices synchronized? Check the 3D eyewear settings.• Change the [LEFT/RIGHT SWAP] setting of [3D SETTINGS].	— 93
Image in the 3D eyewear flickers.	<ul style="list-style-type: none">• Are you within the reception range?	—
3D eyewear is not functioning.	<ul style="list-style-type: none">• Are batteries of the 3D eyewear drained? If you use the rechargeable 3D eyewear, charge it. If you use the battery-powered 3D eyewear, replace the battery.• Is the [3D SETTINGS] setting correct?	— 91

Attention

- If problems persist even after checking the preceding points, consult your dealer.

Chapter 6 Appendix

This chapter describes specifications and after-sales service for the projector.

Technical information

PJLink protocol

The network function of this projector supports the PJLink class 1, and the PJLink protocol can be used to perform projector setting and projector status query operations from a computer.

Control commands

The following table lists the PJLink protocol commands that can be used to control the projector.

- x characters in tables are non-specific characters.

Command	Control details	Parameter / return string	Remark		
POWR	Power supply control	0	Standby		
		1	Power on		
POWR?	Power supply status query	0	Standby		
		1	Power on		
		2	Preparing for switching off the projector		
		3	Warm-up		
INPT	Input selection	11	RGB1		
		12	RGB2		
		21	VIDEO		
INPT?	Input selection query	31	DVI-D		
		32	HDMI		
		33	SDI1 (only for PT-DZ13KE, PT-DS12KE), SDI (only for PT-DZ10KE)		
		34	SDI2 (only for PT-DZ13KE, PT-DS12KE)		
		30	Shutter function off (shutter open)		
AVMT?	Shutter status query	31	Shutter function on (shutter closed)		
ERST?	Error status query	xxxxxx	1st byte	Indicates fan errors, and returns 0 - 2.	<ul style="list-style-type: none"> • 0 = No error is detected • 1 = Warning • 2 = Error
			2nd byte	Indicates lamp errors, and returns 0 - 2.	
			3rd byte	Indicates temperature errors, and returns 0 - 2.	
			4th byte	Indicates cover open errors, and returns 0 or 2.	
			5th byte	Indicates filter errors, and returns 0 - 2.	
			6th byte	Indicates other errors, and returns 0 - 2.	
LAMP?	Lamp status query	xxxxxxxxxxx	1st digits (1 - 5 digits): Lamp 1 runtime 2nd digit: 0 = Lamp 1 off, 1 = Lamp 1 on 3rd digits (1 - 5 digits): Lamp 2 runtime 4th digit: 0 = Lamp 2 off, 1 = Lamp 2 on		
INST?	Input selection list query	11 12 21 31 32 33 34	Only for PT-DZ13KE, PT-DS12KE		
		11 12 21 31 32	Only for PT-DW11KE		
		11 12 21 31 32 33	Only for PT-DZ10KE		
NAME?	Projector name query	xxxxx	Returns the name set in [PROJECTOR NAME] of [NETWORK SETUP].		
INF1?	Manufacturer name query	Panasonic	Returns manufacturer name.		
INF2?	Model name query	DZ13K DS12K DW11K DZ10K	Returns model name.		
INF0?	Other information queries	xxxxx	Returns information such as version number.		
CLSS?	Class information query	1	Returns class for PJLink.		

PJLink security authentication

The password used for PJLink is the same as that of the password set for web control.

When using the projector without security authentication, do not set a password for web control.

- For specifications related to PJLink, refer to the website of Japan Business Machine and Information System Industries Association.
URL <http://pjlink.jbmia.or.jp/english/>

Using Art-Net function

Since the network function of the projector supports the Art-Net function, you can control the projector settings with the DMX controller or application software using the Art-Net protocol.

Channel definition

The following table lists the channel definitions used for controlling the projector with the Art-Net function.

Channel	Control details	Performance	Parameter	Initial value	Remark	
1	Light volume adjustment	100 %	0	0	Can be set in 256 steps between 100 % and 0 %.	
				
		0 %	255			
2	Input selection	No operation	0-7	0	—	
		RGB1	8-15			
		RGB2	16-23			
		DVI-D	24-31			
		HDMI	32-39			
		No operation	40-47			
		SDI1 (only for PT-DZ13KE, PT-DS12KE, PT-DZ10KE)	48-55			
		SDI2 (only for PT-DZ13KE, PT-DS12KE)	56-63			
		No operation	64-127			
		Execute P IN P, USER1	128-135			
		Execute P IN P, USER2	136-143			
Execute P IN P, USER3	144-151					
No operation	152-255					
3	Lens position	No operation	0-31	0	—	
		Move to the home position	32-63			
		Move to [1:LENS MEMORY1]	64-95			
		Move to [2:LENS MEMORY2]	96-127			
		Move to [3:LENS MEMORY3]	128-159			
		No operation	160-191			
4	Lens H shift	Lens adjustment	(-) High speed	0-31	128	—
			(-) Low speed	32-63		
5	Lens V shift	Lens adjustment	(-) Fine adjustment	64-95		
			Adjustment stop	96-159		
6	Lens focus	Lens adjustment	(+) Fine adjustment	160-191		
			(+) Low speed	192-223		
7	Lens zoom		(+) High speed	224-255		
8	Power supply control	Standby	0-63	128	—	
		No operation	64-191			
		Power on	192-255			
9	GEOMETRY	OFF	0-15	255	(Only for PT-DZ13KE, PT-DS12KE) To use [PC-1], [PC-2], and [PC-3], the optional Upgrade Kit (Model No.: ET-UK20) is required.	
		KEystone	16-31			
		CURVED	32-47			
		[PC-1]	48-63			
		[PC-2]	64-79			
		[PC-3]	80-95			
		CORNER CORRECTION	96-111			
No operation	112-255					

Channel	Control details	Performance	Parameter	Initial value	Remark
10	CUSTOM MASKING	OFF	0-31	255	(Only for PT-DZ13KE, PT-DS12KE) To use this function, the optional Upgrade Kit (Model No.: ET-UK20) is required.
		[PC-1]	32-63		
		[PC-2]	64-95		
		[PC-3]	96-127		
		No operation	128-255		
11	Lock	Operation not available	0-127	0	When "Operation not available" is set, operations of all channels become unacceptable.
		Operation available	128-255		

Note

- If the projector is operated with the remote control or on the control panel, or by the control command while controlling the projector using the Art-Net function, the setting of the DMX controller and the computer application may be different from the projector status. To reflect the controls of all channels to the projector in that case, set "Lock" of channel 11 to "Operation not available" and then set back to "Operation available".
- When "Light volume adjustment" in channel 1 is set to 0 %, image and on-screen display disappear.

Control commands via LAN

When web control administrator rights password is set (Protect mode)

Connecting

1) Obtain the IP address and port number (Initial set value = 1024) of the projector and request for a connection to the projector.

- You can obtain both the IP address and the port number from the menu screen of the projector.

IP address	Obtain from the main menu → [NETWORK] → [NETWORK STATUS]
Port number	Obtain from the main menu → [NETWORK] → [NETWORK CONTROL] → [COMMAND PORT]

2) Check the response from the projector.

	Data section	Blank	Mode	Blank	Random number section	Termination symbol
Command example	"NTCONTROL" (ASCII string)	' '	'1'	' '	"zzzzzzzz" (ASCII code hex number)	(CR) 0x0d
Data length	9 bytes	1 byte	1 byte	1 byte	8 bytes	1 byte

- Mode: 1 = Protect mode

3) Generate a 32-byte hash value from the following data using MD5 algorithm.

- "xxxxxx:yyyyy:zzzzzzzz"

xxxxxx	Administrator rights user name for the web control (default user name is "admin1")
yyyyy	Password of above administrator rights user (default password is "panasonic")
zzzzzzzz	8-byte random number obtained in Step 2)

Command transmission method

Transmit using the following command formats.

■ Transmitted data

	Header			Data section	Termination symbol
Command example	Hash value (Refer to "Connecting" above)	'0'	'0'	Control command (ASCII string)	(CR) 0x0d
Data length	32 bytes	1 byte	1 byte	Undefined length	1 byte

■ Received data

	Header		Data section	Termination symbol
Command example	'0' 0x30	'0' 0x30	Control command (ASCII string)	(CR) 0x0d
Data length	1 byte	1 byte	Undefined length	1 byte

■ Error response

	String	Details	Termination symbol
Message	"ERR1"	Undefined control command	(CR) 0x0d
	"ERR2"	Out of parameter range	
	"ERR3"	Busy state or no-acceptable period	
	"ERR4"	Timeout or no-acceptable period	
	"ERR5"	Wrong data length	
Data length	4 bytes	—	1 byte

When web control administrator rights password is not set (Non-protect mode)

Connecting

1) Obtain the IP address and port number (Initial set value = 1024) of the projector and request for a connection to the projector.

- You can obtain both the IP address and the port number from the menu screen of the projector.

IP address	Obtain from the main menu → [NETWORK] → [NETWORK STATUS]
Port number	Obtain from the main menu → [NETWORK] → [NETWORK CONTROL] → [COMMAND PORT]

2) Check the response from the projector.

	Data section	Blank	Mode	Termination symbol
Command example	"NTCONTROL" (ASCII string)	' ' 0x20	'0' 0x30	(CR) 0x0d
Data length	9 bytes	1 byte	1 byte	1 byte

- Mode: 0 = Non-protect mode

Command transmission method

Transmit using the following command formats.

■ Transmitted data

	Header		Data section	Termination symbol
Command example	'0' 0x30	'0' 0x30	Control command (ASCII string)	(CR) 0x0d
Data length	1 byte	1 byte	Undefined length	1 byte

■ Received data

	Header		Data section	Termination symbol
Command example	'0' 0x30	'0' 0x30	Control command (ASCII string)	(CR) 0x0d
Data length	1 byte	1 byte	Undefined length	1 byte

■ Error response

	String	Details	Termination symbol
Message	"ERR1"	Undefined control command	(CR) 0x0d
	"ERR2"	Out of parameter range	
	"ERR3"	Busy state or no-acceptable period	
	"ERR4"	Timeout or no-acceptable period	
	"ERR5"	Wrong data length	
	"ERRA"	Password mismatch	
Data length	4 bytes	—	1 byte

<SERIAL IN>/<SERIAL OUT> terminal

The <SERIAL IN>/<SERIAL OUT> terminal of the projector conforms with RS-232C so that the projector can be connected to and controlled from a computer.

Connection

● Single projector

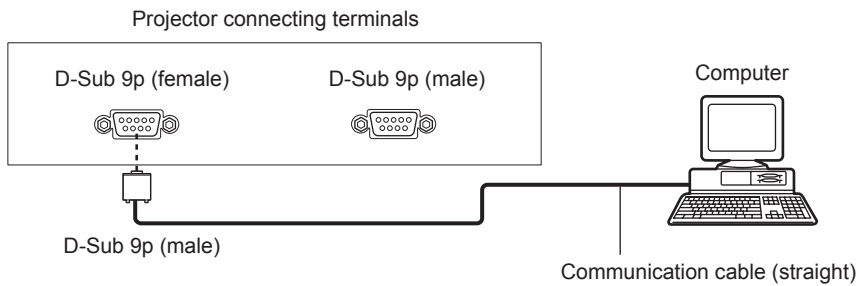

● Multiple projectors

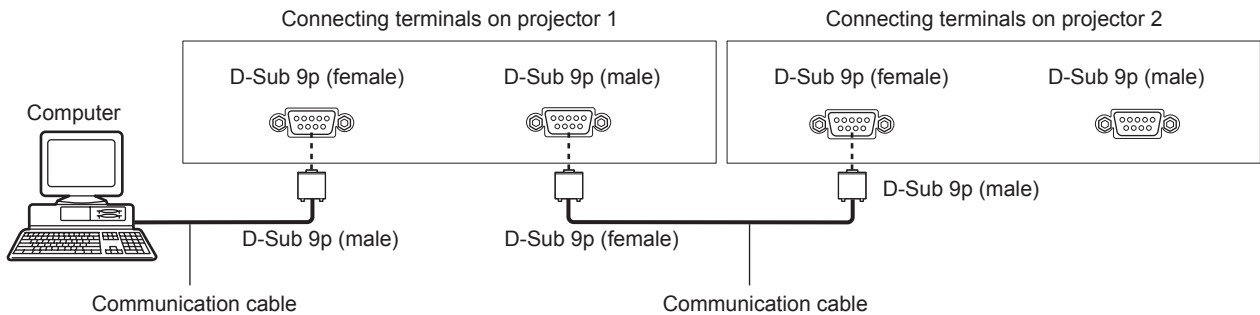

Note

- The destination of [RS-232C] (➔ page 118) must be set according to the connection method.

Pin assignments and signal names

D-Sub 9-pin (female) Outside view	Pin No.	Signal name	Details
	(1)	—	NC
	(2)	TXD	Transmitted data
	(3)	RXD	Received data
	(4)	—	NC
	(5)	GND	Earth
	(6)	—	NC
	(7)	CTS	Connected internally
	(8)	RTS	
	(9)	—	NC

D-Sub 9-pin (male) Outside view	Pin No.	Signal name	Details
	(1)	—	NC
	(2)	RXD	Received data
	(3)	TXD	Transmitted data
	(4)	—	NC
	(5)	GND	Earth
	(6)	—	NC
	(7)	RTS	Connected internally
	(8)	CTS	
	(9)	—	NC

Communication conditions (Factory default)

Signal level	RS-232C-compliant
Sync. method	Asynchronous
Baud rate	9 600 bps
Parity	None
Character length	8 bits
Stop bit	1 bit
X parameter	None
S parameter	None

Basic format

Transmission from the computer starts with STX, then the ID, command, parameter, and ETX are sent in this order. Add parameters according to the details of control.

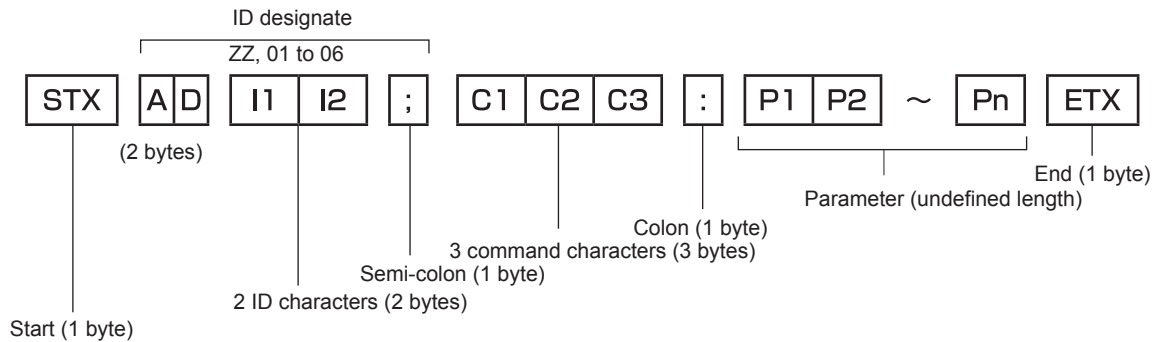

Basic format (has subcommands)

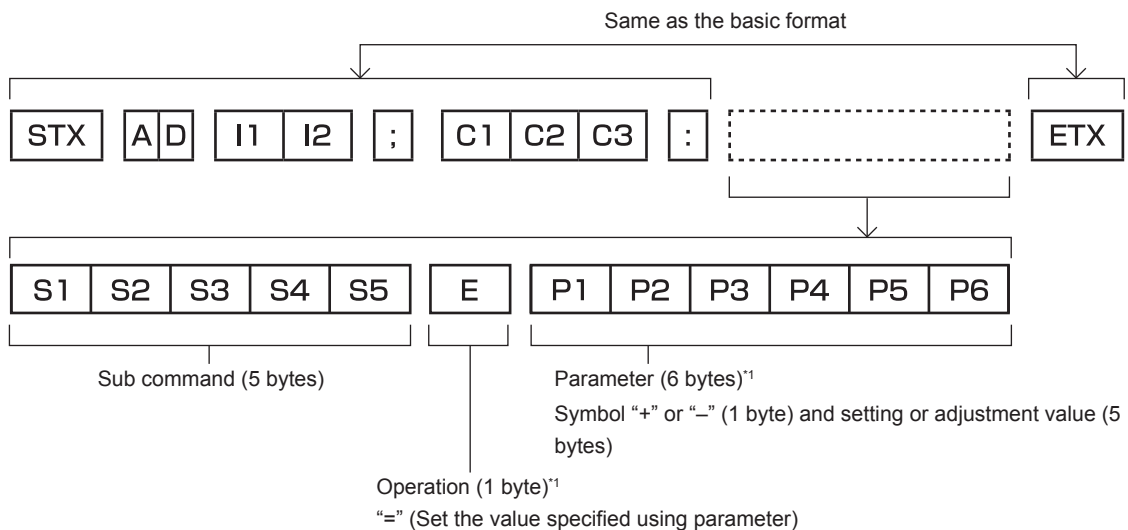

*1 When transmitting a command which does not need a parameter, an operation (E) and parameter are not necessary.

Attention

- If a command is transmitted after the lamp starts illuminating, there may be a delay in response or the command may not be executed. Try sending or receiving any command after 60 seconds.
- When transmitting multiple commands, be sure to wait until 0.5 seconds has elapsed after receiving the response from the projector before sending the next command. When transmitting a command which does not need a parameter, a colon (:) is not necessary.

Note

- If a command cannot be executed, the “ER401” response is sent from the projector to the computer.
- If an invalid parameter is sent, the “ER402” response is sent from the projector to the computer.
- ID transmission in RS-232C supports ZZ (ALL) and 01 to 64, as well as 0A to 0Z groups.
- If a command is sent with a specified ID, a response will be sent to the computer only in the following cases.
 - It matches the projector ID
 - ID setting is set to ALL and [RESPONSE(ID ALL)] is [ON]
 - ID setting is set to GROUP and [RESPONSE(ID GROUP)] is [ON]
- STX and ETX are character codes. STX shown in hexadecimal is 02, and ETX shown in hexadecimal is 03.

When multiple projectors are controlled

When multiple projectors are all controlled

When controlling multiple projectors together via RS-232C, perform the following settings.

- 1) Set a different ID for each projector.
- 2) Set [RESPONSE(ID ALL)] to [ON] in only one projector.
- 3) Set [RESPONSE(ID ALL)] to [OFF] for all other projectors set in Step 2).

When multiple projectors are all controlled by group unit

When controlling multiple projectors by group unit via RS-232C, perform the following settings.

- 1) Set a different ID for each projector.
- 2) Set [RESPONSE(ID GROUP)] to [ON] in only one projector.
- 3) Set [RESPONSE(ID GROUP)] to [OFF] for all other projectors set in Step 2).

Note

- There will be no response if two or more projectors have [RESPONSE(ID ALL)] set to [ON].
- There will be no response if two or more projectors of the same group have [RESPONSE(ID GROUP)] set to [ON].
- When setting multiple groups, set [RESPONSE(ID ALL)] to [ON] in only one projector in each group.

Cable specification

When connected to a computer

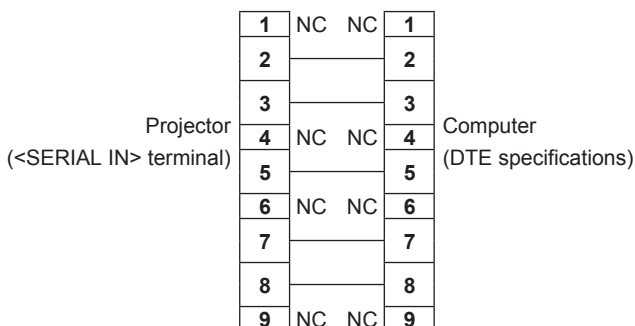

When multiple projectors are connected

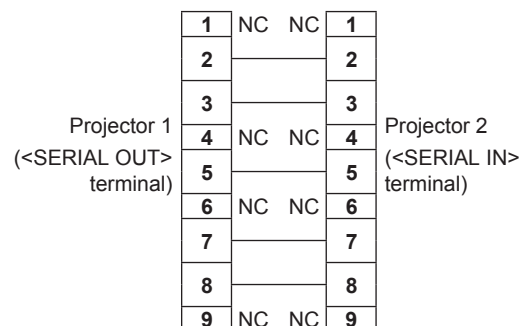

Control command

The following table lists the commands that can be used to control the projector using a computer.

■ Projector control command

Command	Details	Parameter/response string	Remark (parameter)
PON	Power on	—	To check if the power is on, use the "Power query" command.
POF	Power standby		
QPW	Power query	000 001	STANDBY Power on
IIS	Switching the input signal	VID RG1 RG2 DVI HD1 SD1 SD2	VIDEO RGB1 RGB2 DVI-D HDMI SDI1 (only for PT-DZ13KE, PT-DS12KE, PT-DZ10KE) SDI2 (only for PT-DZ13KE, PT-DS12KE)
QSL	Query for lamp selection	0 1 2 3	DUAL SINGLE LAMP1 LAMP2
LPM	Lamp selection	0 1 2 3	DUAL SINGLE*1 LAMP1 LAMP2
OLP	Lamp power	0 1 8	HIGH (only for PT-DZ13KE, PT-DS12KE, PT-DW11KE) NORMAL (only for PT-DZ10KE) ECO MIDDLE (only for PT-DZ13KE, PT-DS12KE, PT-DW11KE)
Q\$L	Lamp cumulative runtime query	1 2	LAMP1 LAMP2 Response is 0000 to 4000
OSH	Shutter	0	OPEN
QSH	Shutter status query	1	CLOSE
VSE	Aspect ratio switch	0 1 2 5	DEFAULT/VID AUTO 4:3 16:9 THROUGH
QSE	Aspect ratio settings query	6 9 10	HV FIT H FIT V FIT
OPP	P IN P execute	0 1 2 3	OFF USER1 USER2 USER3
QPP	P IN P setting query	0 1 2 3	OFF USER1 USER2 USER3
OCS	Sub memory switch	01 - 96	Sub memory number
QSB	Sub memory status query		

*1 Use Lamp 1 or Lamp 2 whichever has a shorter runtime.

■ Projector control command (with sub command)

Command	Sub command	Details	Remark
VXX	RYC11	RGB1 input setting	+00000 = RGB/YP _B P _R , +00001 = Y/C

■ Lens control command

Command	Sub command	Details	Remark
VXX	LNSI2	Lens H shift	+00000 = Fine adjustment 1+, +00001 = Fine adjustment 1-, +00100 = Fine adjustment 2+, +00101 = Fine adjustment 2-, +00200 = Coarse adjustment+, +00201 = Coarse adjustment-
VXX	LNSI3	Lens V shift	
VXX	LNSI4	Lens focus	
VXX	LNSI5	Lens zoom	

<REMOTE 2 IN> terminal

It is possible to control the projector remotely (by external contact) from a control panel located away from the projector where remote control signals cannot reach.

Use the <REMOTE 2 IN> terminal on the connecting terminals of the projector to connect to the control panel.

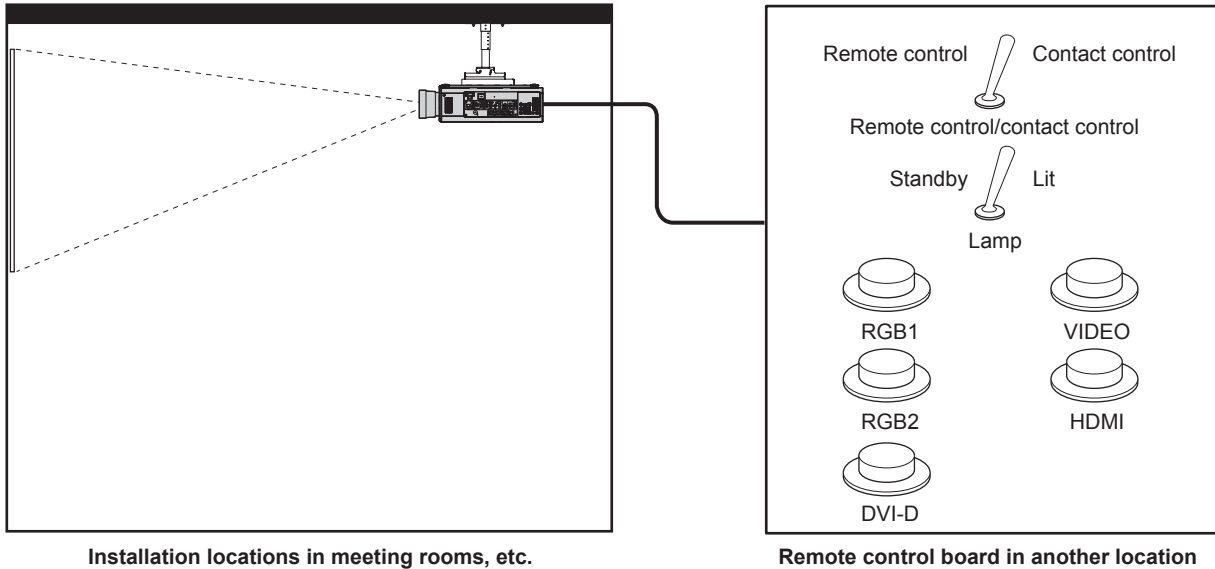

Pin assignments and signal names

D-Sub 9-pin Outside view	Pin No.	Signal name	Open (H)	Short (L)
	(1)	GND	—	GND
	(2)	POWER	OFF	ON
	(3)	RGB1	Other	RGB1
	(4)	RGB2	Other	RGB2
	(5)	VIDEO	Other	VIDEO
	(6)	HDMI	Other	HDMI
	(7)	DVI-D	Other	DVI-D
	(8)	SHUTTER	OFF	ON
	(9)	RST/SET	Controlled by remote control	Controlled by external contact

Attention

- When controlling, make sure to short-circuit pins (1) and (9).
- When pins (1) and (9) are short-circuited, the following buttons on the control panel and the remote control cannot be used. The power on <|> button, the power standby <ϕ> button, the <SHUTTER> button, and the RS-232C commands and network functions corresponding to these functions cannot be used either.
- When pins (1) and (9) are short-circuited, if any pins from (3) to (7) are short-circuited with pin (1), the following buttons on the control panel and the remote control cannot be used. The power on <|> button, the power standby <ϕ> button, <RGB1> button, <RGB2> button, <DVI-D> button, <VIDEO> button, <HDMI> button, <SDI 1/2> button, <SHUTTER> button, and the RS-232C commands and network functions corresponding to these functions cannot be used either.

Note

- For pin (2) to pin (8) settings, you can make changes if you set [REMOTE2 MODE] to [USER]. (➡ page 120)

Two-window display combination list

Main window		Sub window					
		RGB1			RGB2		VIDEO input
		RGB	Movie ^{*3}	Y/C input	RGB	Movie ^{*3}	
RGB1	RGB	—	—	—	✓	✓	✓
	Movie ^{*3}	—	—	—	✓	▲	▲
	Y/C input	—	—	—	✓	▲	—
RGB2	RGB	✓	✓	✓	—	—	✓
	Movie ^{*3}	✓	▲	▲	—	—	▲
VIDEO input		✓	▲	—	✓	▲	—
DVI-D	RGB ^{*2}	✓	✓	✓	✓	✓	✓
	Movie ^{*1}	✓	▲	▲	✓	▲	▲
HDMI	RGB ^{*2}	✓	✓	✓	✓	✓	✓
	Movie ^{*1}	✓	▲	▲	✓	▲	▲
SDI1 ^{*4} /SDI ^{*6}		✓	▲	▲	✓	▲	▲
SDI2 ^{*5}		✓	▲	▲	✓	▲	▲
Dual link HD-SDI ^{*7}		—	—	▲	—	—	▲

Main window		Sub window						
		DVI-D		HDMI		SDI1 ^{*4}	SDI2 ^{*5}	Dual link HD-SDI ^{*7}
		RGB ^{*2}	Movie ^{*1}	RGB ^{*2}	Movie ^{*1}			
RGB1	RGB	✓	✓	✓	✓	✓	✓	—
	Movie ^{*3}	✓	▲	✓	▲	▲	▲	—
	Y/C input	✓	▲	✓	▲	▲	▲	▲
RGB2	RGB	✓	✓	✓	✓	✓	✓	—
	Movie ^{*3}	✓	▲	✓	▲	▲	▲	—
VIDEO input		✓	▲	✓	▲	▲	▲	▲
DVI-D	RGB ^{*2}	—	—	✓	✓	✓	—	—
	Movie ^{*1}	—	—	✓	▲	▲	—	—
HDMI	RGB ^{*2}	✓	✓	—	—	—	✓	—
	Movie ^{*1}	✓	▲	—	—	—	▲	—
SDI1 ^{*4} /SDI ^{*6}		✓	▲	—	—	—	▲	—
SDI2 ^{*5}		—	—	✓	▲	▲	—	—
Dual link HD-SDI ^{*7}		—	—	—	—	—	—	—

✓: P IN P (picture in picture) combination is possible

▲: P IN P (picture in picture) combination is possible through the same frequency

—: P IN P (picture in picture) combination is not possible

*1 Only supports 480p, 576p, 720/60p, 720/50p, 1080/60i, 1080/50i, 1080/24sF, 1080/24p, 1080/25p, 1080/30p, 1080/50p, and 1080/60p

*2 VGA (640 x 480) - WUXGA (1 920 x 1 200)

Non-interlace signal, dot clock frequency: 25 MHz to 162 MHz (The WUXGA signal is only compatible with VESA CVT RB (Reduced Blanking) signals.)

*3 480i, 480p, 576i, 576p, 720/50p, 1080/60i, 1080/50i, 1080/24sF, 1080/24p, 1080/25p, 1080/30p, 1080/50p, 1080/60p

*4 SDI1 (only for PT-DZ13KE, PT-DS12KE)

*5 SDI2 (only for PT-DZ13KE, PT-DS12KE)

*6 SDI (only for PT-DZ10KE)

*7 Dual link HD-SDI (only for PT-DZ13KE, PT-DS12KE)

Control device password

To initialize your password, consult your distributor.

Upgrade Kit

(Only for PT-DZ13KE, PT-DS12KE)

If the optional Upgrade Kit (Model No.: ET-UK20) is applied, the following functions are extended.

Function	Standard status	When the Upgrade Kit is applied
Adjustment range of [VERTICAL KEYSTONE]	Maximum of $\pm 40^{\circ*1}$	Maximum of $\pm 45^{\circ*1}$
Adjustment range of [HORIZONTAL KEYSTONE]	Maximum of $\pm 15^{\circ*1}$	Maximum of $\pm 40^{\circ*1}$
Adjustment range of [CURVED]	Vertical arc, Maximum $\pm 50^{\circ*1}$ Horizontal arc, Maximum $\pm 50^{\circ*1}$	Vertical arc, Maximum $\pm 100^{\circ*1}$ Horizontal arc, Maximum $\pm 100^{\circ*1}$
[CUSTOM MASKING]	Cannot be used.	The image can be masked in optional form.
[PC CORRECTION] of [UNIFORMITY]	Cannot be used.	The brightness and unevenness of color of the entire screen can be corrected.

*1 The adjustment range of the menu. Refer to "[GEOMETRY] projection range" (➔ page 33) for the possible projection range.
For details, refer to the Operating Instructions included in the CD-ROM of the optional Upgrade Kit (Model No.: ET-UK20).

List of compatible signals

The following table specifies the video signals compatible with the projector.

- Symbols that indicate formats are as follows.
 - V: VIDEO, Y/C
 - R: RGB
 - Y: $YCbCr/YPbPr$
 - D: DVI-D
 - H: HDMI
 - S: SDI

Mode	Resolution (Dots)	Scanning freq.		Dot clock freq. (MHz)	Format	Plug and play*1				
		Horizontal (kHz)	Vertical (Hz)			RGB2	DVI-D			HDMI
						EDID1	EDID2	EDID3		
NTSC/NTSC4.43/ PAL-M/PAL60	720 x 480i	15.7	59.9	—	V	—	—	—	—	—
PAL/PAL-N/SECAM	720 x 576i	15.6	50.0	—	V	—	—	—	—	—
525i (480i)	720 x 480i	15.7	59.9	13.5	R/Y/S ²	—	—	—	—	—
625i (576i)	720 x 576i	15.6	50.0	13.5	R/Y/S ²	—	—	—	—	—
525i (480i)	720 (1440) x 480i ³	15.7	59.9	27.0	D/H	—	—	—	—	—
625i (576i)	720 (1440) x 576i ³	15.6	50.0	27.0	D/H	—	—	—	—	—
525p (480p)	720 x 483	31.5	59.9	27.0	R/Y/D/H	—	✓	—	✓	✓
625p (576p)	720 x 576	31.3	50.0	27.0	R/Y/D/H	—	✓	—	✓	✓
750 (720)/60p	1 280 x 720	45.0	60.0	74.3	R/Y/D/H/S ²	—	✓	—	✓	✓
750 (720)/50p	1 280 x 720	37.5	50.0	74.3	R/Y/D/H/S ²	—	✓	—	✓	✓
1125 (1080)/60i ⁴	1 920 x 1 080i	33.8	60.0	74.3	R/Y/D/H/S	—	✓	—	✓	✓
1125 (1080)/50i	1 920 x 1 080i	28.1	50.0	74.3	R/Y/D/H/S	—	✓	—	✓	✓
1125 (1080)/24p	1 920 x 1 080	27.0	24.0	74.3	R/Y/D/H/S	—	✓	—	✓	✓
1125 (1080)/24sF	1 920 x 1 080i	27.0	48.0	74.3	R/Y/D/H/S	—	—	—	—	—
1125 (1080)/25p	1 920 x 1 080	28.1	25.0	74.3	R/Y/D/H/S	—	✓	—	✓	—
1125 (1080)/30p	1 920 x 1 080	33.8	30.0	74.3	R/Y/D/H/S	—	—	—	—	—
1125 (1080)/60p	1 920 x 1 080	67.5	60.0	148.5	R/Y/D/H/S ^{2*5}	—	✓	—	✓	✓
1125 (1080)/50p	1 920 x 1 080	56.3	50.0	148.5	R/Y/D/H/S ^{2*5}	—	✓	—	✓	✓
2K/24p	2 048 x 1 080	27.0	24.0	74.3	S ⁶	—	—	—	—	—
2K/24sF	2 048 x 1 080	27.0	24.0	74.3	S ⁶	—	—	—	—	—
VESA400	640 x 400	31.5	70.1	25.2	R/D/H	—	—	—	—	—
	640 x 400	37.9	85.1	31.5	R/D/H	—	—	—	—	—
VGA480	640 x 480	31.5	59.9	25.2	R/D/H	✓	✓	✓	✓	✓
	640 x 480	35.0	66.7	30.2	R/D/H	—	—	—	—	—
	640 x 480	37.9	72.8	31.5	R/D/H	✓	—	✓	✓	✓
	640 x 480	37.5	75.0	31.5	R/D/H	✓	—	✓	✓	✓
	640 x 480	43.3	85.0	36.0	R/D/H	—	—	—	—	—

Chapter 6 Appendix — Technical information

Mode	Resolution (Dots)	Scanning freq.		Dot clock freq. (MHz)	Format	Plug and play ^{*1}				
		Horizontal (kHz)	Vertical (Hz)			RGB2	DVI-D			HDMI
						EDID1	EDID2	EDID3		
SVGA	800 x 600	35.2	56.3	36.0	R/D/H	✓	—	✓	✓	✓
	800 x 600	37.9	60.3	40.0	R/D/H	✓	—	✓	✓	✓
	800 x 600	48.1	72.2	50.0	R/D/H	✓	—	✓	✓	✓
	800 x 600	46.9	75.0	49.5	R/D/H	✓	—	✓	✓	✓
	800 x 600	53.7	85.1	56.3	R/D/H	—	—	—	—	—
MAC16	832 x 624	49.7	74.6	57.3	R/D/H	✓	—	✓	✓	✓
XGA	1 024 x 768	39.6	50.0	51.9	R/D/H	—	—	—	—	—
	1 024 x 768	48.4	60.0	65.0	R/D/H	✓	—	✓	✓	✓
	1 024 x 768	56.5	70.1	75.0	R/D/H	✓	—	✓	✓	✓
	1 024 x 768	60.0	75.0	78.8	R/D/H	✓	—	✓	✓	✓
	1 024 x 768	65.5	81.6	86.0	R/D/H	—	—	—	—	—
	1 024 x 768	68.7	85.0	94.5	R/D/H	—	—	—	—	—
	1 024 x 768	81.4	100.0	113.3	R/D/H ^{*7}	—	—	—	—	—
	1 024 x 768	98.8	120.0	139.1	R/D/H ^{*7}	✓	—	✓	✓	✓
MXGA	1 152 x 864	53.7	60.0	81.6	R/D/H	—	—	—	—	—
	1 152 x 864	64.0	70.0	94.2	R/D/H	—	—	—	—	—
	1 152 x 864	67.5	74.9	108.0	R/D/H	—	—	—	—	—
	1 152 x 864	76.7	85.0	121.5	R/D/H	—	—	—	—	—
MAC21	1 152 x 870	68.7	75.1	100.0	R/D/H	✓	—	✓	✓	✓
1280 x 720	1 280 x 720	37.1	49.8	60.5	R/D/H	—	—	—	—	—
	1 280 x 720	44.8	59.9	74.5	R/D/H	—	—	—	—	—
	1 280 x 720	76.3	100.0	131.8	R/D/H ^{*7}	—	—	—	—	—
	1 280 x 720	92.6	120.0	161.6	R/D/H ^{*7}	—	—	—	—	—
1280 x 768	1 280 x 768	39.6	49.9	65.3	R/D/H	—	—	—	—	—
	1 280 x 768	47.8	59.9	79.5	R/D/H	—	—	—	—	—
	1 280 x 768 ^{*8}	47.4	60.0	68.3	R/D/H	—	—	—	—	—
	1 280 x 768	60.3	74.9	102.3	R/D/H	—	—	—	—	—
	1 280 x 768	68.6	84.8	117.5	R/D/H	—	—	—	—	—
1280 x 800	1 280 x 800	41.3	50.0	68.0	R/D/H	—	—	—	—	—
	1 280 x 800	49.7	59.8	83.5	R/D/H	—	—	—	—	—
	1 280 x 800 ^{*8}	49.3	59.9	71.0	R/D/H	—	—	—	—	—
	1 280 x 800	62.8	74.9	106.5	R/D/H	—	—	—	—	—
	1 280 x 800	71.6	84.9	122.5	R/D/H	—	—	—	—	—
MSXGA	1 280 x 960	60.0	60.0	108.0	R/D/H	—	—	—	—	—
SXGA	1 280 x 1 024	52.4	50.0	88.0	R/D/H	—	—	—	—	—
	1 280 x 1 024	64.0	60.0	108.0	R/D/H	✓	—	✓	✓	✓
	1 280 x 1 024	72.3	66.3	125.0	R/D/H	—	—	—	—	—
	1 280 x 1 024	78.2	72.0	135.1	R/D/H	—	—	—	—	—
	1 280 x 1 024	80.0	75.0	135.0	R/D/H	✓	—	✓	✓	✓
	1 280 x 1 024	91.1	85.0	157.5	R/D/H	—	—	—	—	—
1366 x 768	1 366 x 768	47.7	59.8	85.5	R/D/H	✓ ^{*9}	—	✓ ^{*9}	✓ ^{*9}	✓ ^{*9}
	1 366 x 768	39.6	49.9	69.0	R/D/H	—	—	—	—	—
SXGA+	1 400 x 1 050	54.1	50.0	99.9	R/D/H	—	—	—	—	—
	1 400 x 1 050	64.0	60.0	108.0	R/D/H	—	—	—	—	—
	1 400 x 1 050	65.2	60.0	122.6	R/D/H	✓	—	✓	✓	✓
	1 400 x 1 050	65.3	60.0	121.8	R/D/H	—	—	—	—	—
	1 400 x 1 050	78.8	72.0	149.3	R/D/H	—	—	—	—	—
	1 400 x 1 050	82.2	75.0	155.9	R/D/H	—	—	—	—	—
WXGA+	1 440 x 900	55.9	59.9	106.5	R/D/H	—	—	—	—	—
	1 440 x 900	46.3	49.9	86.8	R/D/H	—	—	—	—	—
UXGA60	1 600 x 1 200	75.0	60.0	162.0	R/D/H	✓	—	✓	✓	✓
WSXGA+	1 680 x 1 050	65.3	60.0	146.3	R/D/H	—	—	—	—	—
	1 680 x 1 050	54.1	50.0	119.5	R/D/H	—	—	—	—	—

Mode	Resolution (Dots)	Scanning freq.		Dot clock freq. (MHz)	Format	Plug and play ^{*1}				
		Horizontal (kHz)	Vertical (Hz)			RGB2	DVI-D			HDMI
							EDID1	EDID2	EDID3	
1920 x 1080	1 920 x 1 080	55.6	49.9	141.5	R/D/H	—	—	—	—	—
	1 920 x 1 080 ^{*8}	66.6	59.9	138.5	R/D/H	—	—	—	—	—
	1 920 x 1 080 ^{*10}	67.2	60.0	173.0	R	—	—	—	—	—
WUXGA	1 920 x 1 200	61.8	49.9	158.3	R/D/H	—	—	—	—	—
	1 920 x 1 200 ^{*8}	74.0	60.0	154.0	R/D/H	✓	—	✓	✓ ^{*11}	✓ ^{*11}
	1 920 x 1 200 ^{*10}	74.6	59.9	193.3	R	—	—	—	—	—

*1 Signals with ✓ in the Plug and play columns are signals described in EDID (extended display identification data) of the projector. A signal, which has no ✓ in the Plug and play columns but has an entry in the Format column, can be input. For signals without ✓ in the Plug and play columns, resolution may not be selected in the computer even though the projector supports them.

*2 For single link connections only

*3 Pixel-Repetition signal (dot clock frequency 27.0 MHz) only

*4 When a 1125 (1035)/60i signal was input, it is displayed as a 1125 (1080)/60i signal.

*5 Only for SDI1

*6 For dual link connections only

*7 When [3D INPUT FORMAT] is set to [AUTO], 3D images in frame sequential format are displayed. To display images in 2D, set [3D INPUT FORMAT] to [NATIVE].

*8 VESA CVT-RB (Reduced Blanking)-compliant

*9 Only for PT-DW11KE

*10 Samples the pixels in the image processing circuit and projects the image.

*11 Only for PT-DZ13KE, PT-DZ10KE

Note

- There are 1 920 x 1 080 display dots for PT-DZ13KE and PT-DZ10KE, 1 400 x 1 050 for PT-DS12KE, and 1 366 x 768 for PT-DW11KE. A signal with a different resolution is converted to the number of display dots.
- The “i” at the end of the resolution indicates an interlaced signal.
- When interlaced signals are connected, flickering may occur on the projected image.

List of 3D compatible signals

(Only for PT-DZ13KE, PT-DS12KE, PT-DW11KE)

The following table specifies the 3D compatible video signals that the projector can project.

Items that are applicable to **1** to **10** in the table are as follows.

- 1 Frame packing system**
- 2 Side by side system**
- 3 Top and bottom system**
- 4 Line by line system**
- 5 Frame sequential system**
- 6 3G-SDI Level B simultaneous system**
- 7 HDMI & DVI-D**
- 8 RGB1 & RGB2**
- 9 SDI1 & SDI2 (only for PT-DZ13KE, PT-DS12KE)**
- 10 Simultaneous system**

3D compatible signal	Resolution (Dots)	Scanning freq.		Dot clock freq. (MHz)	HDMI				DVI-D			
		Horizontal (kHz)	Vertical (Hz)		1	2 ^{*1}	3	5	2 ^{*1}	3	4	5
750 (720)/60p	1 280 x 720	45.0	60.0	74.3	✓	✓	✓	—	✓	✓	✓	—
750 (720)/50p	1 280 x 720	37.5	50.0	74.3	✓	✓	✓	—	✓	✓	✓	—
1080/60i	1 920 x 1 080i	33.8	60.0	74.3	✓	✓	—	—	✓	✓	—	—
1080/50i	1 920 x 1 080i	28.1	50.0	74.3	✓	✓	—	—	✓	✓	—	—
1080/24p	1 920 x 1 080	27.0	24.0	74.3	✓	✓	✓	—	✓	✓	—	—
1080/24sF	1 920 x 1 080i	27.0	48.0	74.3	—	—	—	—	✓	✓	—	—
1080/25p	1 920 x 1 080	28.1	25.0	74.3	—	—	—	—	✓	✓	—	—
1080/30p	1 920 x 1 080	33.8	30.0	74.3	—	—	—	—	✓	✓	—	—
1080/60p	1 920 x 1 080	67.5	60.0	148.5	—	✓	✓	—	✓	✓	—	—
1080/50p	1 920 x 1 080	56.3	50.0	148.5	—	✓	✓	—	✓	✓	—	—
VGA480	640 x 480	31.5	59.9	25.2	—	—	—	—	✓	—	—	—
SVGA	800 x 600	37.9	60.3	40.0	—	—	—	—	✓	—	—	—

Chapter 6 Appendix — Technical information

3D compatible signal	Resolution (Dots)	Scanning freq.		Dot clock freq. (MHz)	HDMI				DVI-D			
		Horizontal (kHz)	Vertical (Hz)		1	2*1	3	5	2*1	3	4	5
XGA	1 024 x 768	39.6	50.0	51.9	—	—	—	—	✓	—	—	—
	1 024 x 768	48.4	60.0	65.0	—	—	—	—	✓	—	—	—
	1 024 x 768	81.4	100.0	113.3	—	—	—	✓	—	—	—	✓
	1 024 x 768	98.8	120.0	139.1	—	—	—	✓	—	—	—	✓
MXGA	1 152 x 864	53.7	60.0	81.6	—	—	—	—	✓	—	—	—
1280 x 720	1 280 x 720	37.1	49.8	60.5	—	—	—	—	✓	—	—	—
	1 280 x 720	44.8	59.9	74.5	—	—	—	—	✓	—	—	—
	1 280 x 720	76.3	100.0	131.8	—	—	—	✓	—	—	—	✓
	1 280 x 720	92.6	120.0	161.6	—	—	—	✓	—	—	—	✓
1280 x 768	1 280 x 768	39.6	49.9	65.3	—	—	—	—	✓	—	—	—
	1 280 x 768	47.8	59.9	79.5	—	—	—	—	✓	—	—	—
	1 280 x 768 ²	47.4	60.0	68.3	—	—	—	—	✓	—	—	—
1280 x 800	1 280 x 800	41.3	50.0	68.0	—	—	—	—	✓	—	—	—
	1 280 x 800	49.7	59.8	83.5	—	—	—	—	✓	—	—	—
	1 280 x 800 ²	49.3	59.9	71.0	—	—	—	—	✓	—	—	—
MSXGA	1 280 x 960	60.0	60.0	108.0	—	—	—	—	✓	—	—	—
SXGA	1 280 x 1 024	52.4	50.0	88.0	—	—	—	—	✓	—	—	—
	1 280 x 1 024	64.0	60.0	108.0	—	—	—	—	✓	—	—	—
1366 x 768	1 366 x 768	47.7	59.8	85.5	—	—	—	—	✓	—	—	—
	1 366 x 768	39.6	49.9	69.0	—	—	—	—	✓	—	—	—
SXGA+	1 400 x 1 050	54.1	50.0	99.9	—	—	—	—	✓	—	—	—
	1 400 x 1 050	64.0	60.0	108.0	—	—	—	—	✓	—	—	—
	1 400 x 1 050	65.2	60.0	122.6	—	—	—	—	✓	—	—	—
	1 400 x 1 050	65.3	60.0	121.8	—	—	—	—	✓	—	—	—
WXGA+	1 440 x 900	55.9	59.9	106.5	—	—	—	—	✓	—	—	—
	1 440 x 900	46.3	49.9	86.8	—	—	—	—	✓	—	—	—
UXGA60	1 600 x 1 200	75.0	60.0	162.0	—	—	—	—	✓	—	—	—
WSXGA+	1 680 x 1 050	65.3	60.0	146.3	—	—	—	—	✓	—	—	—
	1 680 x 1 050	54.1	50.0	119.5	—	—	—	—	✓	—	—	—
1920 x 1080	1 920 x 1 080	55.6	49.9	141.5	—	—	—	—	✓	—	—	—
	1 920 x 1 080 ²	66.6	59.9	138.5	—	—	—	—	✓	—	—	—
WUXGA	1 920 x 1 200	61.8	49.9	158.3	—	—	—	—	✓	—	—	—
	1 920 x 1 200 ²	74.0	60.0	154.0	—	—	—	—	✓	—	✓	—

*1 Supports half.

*2 VESA CVT RB (Reduced Blanking)-compliant

Chapter 6 Appendix — Technical information

3D compatible signal	Resolution (Dots)	Scanning freq.		Dot clock freq. (MHz)	RGB1/RGB2				SDI1/SDI2				7	8	9
		Horizontal (kHz)	Vertical (Hz)		2 ^{*1}	3	4	5	2 ^{*1}	3	4	6 ^{*3}	10	10	10
750 (720)/60p	1 280 x 720	45.0	60.0	74.3	✓	✓	✓	—	✓	✓	✓	✓	✓	✓	✓
750 (720)/50p	1 280 x 720	37.5	50.0	74.3	✓	✓	✓	—	✓	✓	✓	✓	✓	✓	✓
1080/60i	1 920 x 1 080i	33.8	60.0	74.3	✓	✓	—	—	✓	✓	—	✓	✓	✓	✓
1080/50i	1 920 x 1 080i	28.1	50.0	74.3	✓	✓	—	—	✓	✓	—	✓	✓	✓	✓
1080/24p	1 920 x 1 080	27.0	24.0	74.3	✓	✓	—	—	✓	✓	—	✓	✓	✓	✓
1080/24sF	1 920 x 1 080i	27.0	48.0	74.3	✓	✓	—	—	✓	✓	—	✓	✓	✓	✓
1080/25p	1 920 x 1 080	28.1	25.0	74.3	✓	✓	—	—	✓	✓	—	✓	✓	✓	✓
1080/30p	1 920 x 1 080	33.8	30.0	74.3	✓	✓	—	—	✓	✓	—	✓	✓	✓	✓
1080/60p	1 920 x 1 080	67.5	60.0	148.5	✓	✓	—	—	✓ ^{*3}	✓ ^{*3}	—	—	✓	✓	—
1080/50p	1 920 x 1 080	56.3	50.0	148.5	✓	✓	—	—	✓ ^{*3}	✓ ^{*3}	—	—	✓	✓	—
VGA480	640 x 480	31.5	59.9	25.2	✓	—	—	—	—	—	—	—	—	—	—
SVGA	800 x 600	37.9	60.3	40.0	✓	—	—	—	—	—	—	—	—	—	—
XGA	1 024 x 768	39.6	50.0	51.9	✓	—	—	—	—	—	—	—	—	—	—
	1 024 x 768	48.4	60.0	65.0	✓	—	—	—	—	—	—	—	—	—	—
	1 024 x 768	81.4	100.0	113.3	—	—	—	✓	—	—	—	—	—	—	—
	1 024 x 768	98.8	120.0	139.1	—	—	—	✓	—	—	—	—	—	—	—
MXGA	1 152 x 864	53.7	60.0	81.6	✓	—	—	—	—	—	—	—	—	—	—
1280 x 720	1 280 x 720	37.1	49.8	60.5	✓	—	—	—	—	—	—	—	—	—	—
	1 280 x 720	44.8	59.9	74.5	✓	—	—	—	—	—	—	—	—	—	—
	1 280 x 720	76.3	100.0	131.8	—	—	—	✓	—	—	—	—	—	—	—
	1 280 x 720	92.6	120.0	161.6	—	—	—	✓	—	—	—	—	—	—	—
1280 x 768	1 280 x 768	39.6	49.9	65.3	✓	—	—	—	—	—	—	—	—	—	—
	1 280 x 768	47.8	59.9	79.5	✓	—	—	—	—	—	—	—	—	—	—
	1 280 x 768 ^{*2}	47.4	60.0	68.3	✓	—	—	—	—	—	—	—	—	—	—
1280 x 800	1 280 x 800	41.3	50.0	68.0	✓	—	—	—	—	—	—	—	—	—	—
	1 280 x 800	49.7	59.8	83.5	✓	—	—	—	—	—	—	—	—	—	—
	1 280 x 800 ^{*2}	49.3	59.9	71.0	✓	—	—	—	—	—	—	—	—	—	—
MSXGA	1 280 x 960	60.0	60.0	108.0	✓	—	—	—	—	—	—	—	—	—	—
SXGA	1 280 x 1 024	52.4	50.0	88.0	✓	—	—	—	—	—	—	—	—	—	—
	1 280 x 1 024	64.0	60.0	108.0	✓	—	—	—	—	—	—	—	—	—	—
1366 x 768	1 366 x 768	47.7	59.8	85.5	✓	—	—	—	—	—	—	—	—	—	—
	1 366 x 768	39.6	49.9	69.0	✓	—	—	—	—	—	—	—	—	—	—
SXGA+	1 400 x 1 050	54.1	50.0	99.9	✓	—	—	—	—	—	—	—	✓	✓	—
	1 400 x 1 050	64.0	60.0	108.0	✓	—	—	—	—	—	—	—	✓	✓	—
	1 400 x 1 050	65.2	60.0	122.6	✓	—	—	—	—	—	—	—	✓	✓	—
	1 400 x 1 050	65.3	60.0	121.8	✓	—	—	—	—	—	—	—	✓	✓	—
WXGA+	1 440 x 900	55.9	59.9	106.5	✓	—	—	—	—	—	—	—	—	—	—
	1 440 x 900	46.3	49.9	86.8	✓	—	—	—	—	—	—	—	—	—	—
UXGA60	1 600 x 1 200	75.0	60.0	162.0	✓	—	—	—	—	—	—	—	—	—	—
WSXGA+	1 680 x 1 050	65.3	60.0	146.3	✓	—	—	—	—	—	—	—	—	—	—
	1 680 x 1 050	54.1	50.0	119.5	✓	—	—	—	—	—	—	—	—	—	—
1920 x 1080	1 920 x 1 080	55.6	49.9	141.5	✓	—	—	—	—	—	—	—	—	—	—
	1 920 x 1 080 ^{*2}	66.6	59.9	138.5	✓	—	—	—	—	—	—	—	—	—	—
WUXGA	1 920 x 1 200	61.8	49.9	158.3	✓	—	—	—	—	—	—	—	✓	✓	—
	1 920 x 1 200 ^{*2}	74.0	60.0	154.0	✓	—	✓	—	—	—	—	—	✓	✓	—

*1 Supports half.

*2 VESA CVT RB (Reduced Blanking)-compliant

*3 Only supports SDI1

Specifications

The specifications of the projector are as follows.

Power supply		AC 220 V - 240 V, 50 Hz/60 Hz	
Power consumption		PT-DZ13KE	970 W (5 A)
		PT-DS12KE, PT-DW11KE	950 W (4.8 A)
		PT-DZ10KE	900 W (4.9 A)
		0.3 W when [STANDBY MODE] is set to [ECO]	
		9 W when [STANDBY MODE] is set to [NORMAL]	
DLP chip	Size	PT-DZ13KE, PT-DZ10KE	24.4 mm (0.96") (aspect ratio 16:10)
		PT-DS12KE	24.1 mm (0.95") (aspect ratio 4:3)
		PT-DW11KE	21.6 mm (0.85") (aspect ratio 16:9)
	Display system	3-unit DLP chips, DLP type	
	Number of pixels	PT-DZ13KE, PT-DZ10KE	2 304 000 pixels (1 920 x 1 200 dots)
		PT-DS12KE	1 470 000 pixels (1 400 x 1 050 dots)
PT-DW11KE		1 049 088 pixels (1 366 x 768 dots)	
Lens		Optional	
Luminous lamp		PT-DZ13KE, PT-DS12KE, PT-DW11KE	380 W UHM lamp x 2
		PT-DZ10KE	355 W UHM lamp x 2
Light output*1		PT-DZ13KE, PT-DS12KE	12 000 lm ² (ANSI)
		PT-DW11KE	11 000 lm ² (ANSI)
		PT-DZ10KE	10 600 lm (ANSI)
Contrast ratio*1		10 000:1 (when [DYNAMIC IRIS] is set to [3])	
Color system		7 standards (NTSC/NTSC4.43/PAL/PAL-N/PAL-M/SECAM/PAL60)	
Projection screen size		1.78 m (70") to 25.40 m (1 000")	
Screen aspect ratio		PT-DZ13KE, PT-DZ10KE	16:10
		PT-DS12KE	4:3
		PT-DW11KE	16:9
Projection method		[FRONT/CEILING], [FRONT/FLOOR], [REAR/CEILING], [REAR/FLOOR]	
Power cable length		3.0 m (118-1/8")	
Outer case		Molded plastic	
Dimensions	Width	530 mm (20-7/8")	
	Height	200 mm (7-7/8") (with legs at shortest position)	
	Depth	548.5 mm (21-19/32") (excluding the lens)	
Weight		Approx. 24.0 kg (52.9 lbs.) ³	
Noise level*1		PT-DZ13KE, PT-DS12KE, PT-DW11KE	45 dB
		PT-DZ10KE	43 dB
Operating environment	Operating environment temperature*4	0 °C (32 °F) to 45 °C (113 °F)	
	Operating environment humidity	10 % to 80 % (no condensation)	
Remote control	Power supply	DC 3 V (AA/R6 battery x 2)	
	Operating range	Within approx. 30 m (98'5") (when operated directly in front of signal receiver)	
	Weight	134 g (4.7 ozs.) (including batteries)	
	Dimensions	Width: 51 mm (2"), Height: 176 mm (6-15/16"), Depth: 28 mm (1-3/32")	

*1 Measurement, measuring conditions and method of notation all comply with ISO21118 international standards.

*2 In the portrait setting, the light output is 10 600 lm for PT-DZ13KE and PT-DS12KE, and 9 600 lm for PT-DW11KE.

*3 Average value. Weight varies for each product.

*4 When using the projector at high altitudes (1 400 m (4 593') or higher – lower than 2 700 m (8 858') above sea level), the operating environment temperature should be between 0 °C (32 °F) and 40 °C (104 °F).

If you use the Smoke cut filter, the operating environment temperature should be between 0 °C (32 °F) and 35 °C (95 °F). However, it cannot be used at high altitudes.

If you use the Replacement lamp unit (for portrait mode), the operating environment temperature should be between 0 °C (32 °F) and 40 °C (104 °F) when using the projector at elevations lower than 1 400 m (4 593') above sea level, and between 0 °C (32 °F) and 35 °C (95 °F) when using the projector at high altitudes. If you use the Smoke cut filter together, the operating environment temperature should be between 0 °C (32 °F) and 30 °C (86 °F).

If the [PROJECTOR SETUP] menu → [LAMP POWER] is set to [HIGH], [MIDDLE], or [NORMAL], and an ambient temperature reaches 40 °C (104 °F) or higher (35 °C (95 °F) or higher when [HIGH ALTITUDE MODE] is set to [ON] or the Smoke cut filter is used), the light output may decrease by approx. 20 % to protect the projector.

■ **Applicable scanning frequency**

Refer to “List of compatible signals” (➡ page 177) for the types of video signals that can be used with the projector.

For video signal (including Y/C signal)	Horizontal: 15.75 kHz/15.63 kHz, Vertical: 50 Hz/60 Hz	
For RGB signal	Horizontal: 15 kHz to 100 kHz, Vertical: 24 Hz to 120 Hz PIAS (Panasonic Intelligent Auto Scanning) system	
For YC_BC_R/YP_BP_R signal	<ul style="list-style-type: none"> • 525i (480i) Horizontal: 15.75 kHz, Vertical: 60 Hz • 525p (480p) Horizontal: 31.5 kHz, Vertical: 60 Hz • 750 (720)/60p Horizontal: 45 kHz, Vertical: 60 Hz • 1125 (1035)/60i Horizontal: 33.75 kHz, Vertical: 60 Hz • 1125 (1080)/50i Horizontal: 28.13 kHz, Vertical: 50 Hz • 1125 (1080)/24sF Horizontal: 27 kHz, Vertical: 48 Hz • 1125 (1080)/30p Horizontal: 33.75 kHz, Vertical: 30 Hz • 1125 (1080)/50p Horizontal: 56.25 kHz, Vertical: 50 Hz • The SYNC/HD and VD terminals do not support 3 value SYNC. 	<ul style="list-style-type: none"> • 625i (576i) Horizontal: 15.63 kHz, Vertical: 50 Hz • 625p (576p) Horizontal: 31.25 kHz, Vertical: 50 Hz • 750 (720)/50p Horizontal: 37.5 kHz, Vertical: 50 Hz • 1125 (1080)/60i Horizontal: 33.75 kHz, Vertical: 60 Hz • 1125 (1080)/24p Horizontal: 27 kHz, Vertical: 24 Hz • 1125 (1080)/25p Horizontal: 28.13 kHz, Vertical: 25 Hz • 1125 (1080)/60p Horizontal: 67.5 kHz, Vertical: 60 Hz
For DVI-D signal	525i (480i)*1, 625i (576i)*1, 525p (480p), 625p (576p), 750 (720)/60p, 750 (720)/50p, 1125 (1080)/60i, 1125 (1080)/50i, 1125 (1080)/24p, 1125 (1080)/24sF, 1125 (1080)/25p, 1125 (1080)/30p, 1125 (1080)/60p, 1125 (1080)/50p	
	<ul style="list-style-type: none"> • Displayable resolution: VGA to WUXGA (non-interlaced) • Dot clock frequency: 25 MHz to 162 MHz 	
For HDMI signal	525i (480i)*1, 625i (576i)*1, 525p (480p), 625p (576p), 750 (720)/60p, 750 (720)/50p, 1125 (1080)/60i, 1125 (1080)/50i, 1125 (1080)/24p, 1125 (1080)/24sF, 1125 (1080)/25p, 1125 (1080)/30p, 1125 (1080)/60p, 1125 (1080)/50p	
	<ul style="list-style-type: none"> • Displayable resolution: VGA to WUXGA (non-interlaced) • Dot clock frequency: 25 MHz to 162 MHz 	
For SDI signal (Only for PT-DZ13KE, PT-DS12KE, PT-DZ10KE)	<p>SD-SDI signal</p> <p>Single link HD-SDI signal</p> <p>Dual link HD-SDI signal*2</p> <p>3G-SDI signal</p>	<p>SMPTE ST 259 compliant YC_BC_R 4:2:2 10-bit 480i, 576i</p> <p>SMPTE ST 292 compliant YP_BP_R 4:2:2 10-bit 720/50p, 720/60p, 1035/60i, 1080/50i, 1080/60i, 1080/25p, 1080/24p, 1080/24sF, 1080/30p</p> <p>SMPTE ST 372 compliant RGB 4:4:4 12-bit/10-bit 1080/50i, 1080/60i, 1080/25p, 1080/24p, 1080/24sF, 1080/30p X'Y'Z' 4:4:4 12-bit 2048 x 1080/24p, 2048 x 1080/24sF</p> <p>SMPTE ST 424 compliant YP_BP_R 4:2:2 10-bit 1080/50p, 1080/60p RGB 4:4:4 12-bit/10-bit 1080/50i, 1080/60i, 1080/25p, 1080/24p, 1080/24sF, 1080/30p</p> <ul style="list-style-type: none"> • The 3G-SDI signal is only compatible with SDI1.

*1 Pixel-Repetition signal (dot clock frequency 27.0 MHz) only

*2 Only for PT-DZ13KE, PT-DS12KE

■ Terminal

<RGB 1 IN> terminal	1 set (BNC x 5 (RGB/YP _B P _R /YC _B C _R /YC x 1)) RGB signal 0.7 V [p-p] 75 Ω (SYNC ON GREEN: 1.0 V [p-p] 75 Ω) SYNC/HD TTL high impedance, automatic positive/negative polarity compatible VD TTL high impedance, automatic positive/negative polarity compatible YP_BP_R signal Y: 1.0 V [p-p] including synchronization signal, P _B P _R : 0.7 V [p-p] 75 Ω Y/C signal Y: 1.0 V [p-p], C: 0.286 V [p-p] 75 Ω
<RGB 2 IN> terminal	1 set, high-density D-Sub 15 p (female) RGB signal 0.7 V [p-p] 75 Ω (SYNC ON GREEN: 1.0 V [p-p] 75 Ω) SYNC/HD TTL high impedance, automatic positive/negative polarity compatible VD TTL high impedance, automatic positive/negative polarity compatible YP_BP_R signal Y: 1.0 V [p-p] including synchronization signal, P _B P _R : 0.7 V [p-p] 75 Ω
<DVI-D IN> terminal	1 set, DVI-D 24 p, single link, DVI 1.0 compliant, HDCP compatible
<HDMI IN> terminal	1 set, HDMI 19 pin, HDCP compatible, Deep Color compatible
<VIDEO IN> terminal	1 set, BNC 1.0 V [p-p] 75 Ω
<SDI IN 1> terminal (Only for PT-DZ13KE, PT-DS12KE) <SDI IN> terminal (Only for PT-DZ10KE)	1 set (BNC) SD-SDI signal SMPTE ST 259 compliant HD-SDI signal SMPTE ST 292 compliant 3G-SDI signal SMPTE ST 424 compliant Dual link HD-SDI (LINK-A) signal^{*1} SMPTE ST 372 compliant
<SDI IN 2> terminal (Only for PT-DZ13KE, PT-DS12KE)	1 set (BNC) SD-SDI signal SMPTE ST 259 compliant HD-SDI signal SMPTE ST 292 compliant Dual link HD-SDI (LINK-B) signal SMPTE ST 372 compliant
<3D SYNC 1 IN/OUT> terminal (Only for PT-DZ13KE, PT-DS12KE, PT-DW11KE)	1 set (BNC) During input setting TTL high impedance During output setting TTL output: Maximum 10 mA
<3D SYNC 2 OUT> terminal (Only for PT-DZ13KE, PT-DS12KE, PT-DW11KE)	1 set (BNC) TTL output: Maximum 10 mA
<SERIAL IN>/<SERIAL OUT> terminal	D-Sub 9 p, 1 set each, RS-232C compliant, for computer control
<REMOTE 1 IN>/<REMOTE 1 OUT> terminal	M3 stereo mini jack cable, 1 set each, for remote control (wired)/projector connection control
<REMOTE 2 IN> terminal	1 set, D-Sub 9 p, for contact control
<LAN> terminal	1 set, RJ-45, for network connection, PLink compatible, 10Base-T/100Base-TX, Art-Net compatible

*1 Only for PT-DZ13KE, PT-DS12KE

Note

- The model numbers of accessories and optional components are subject to change without prior notice.

Dimensions

Unit: mm

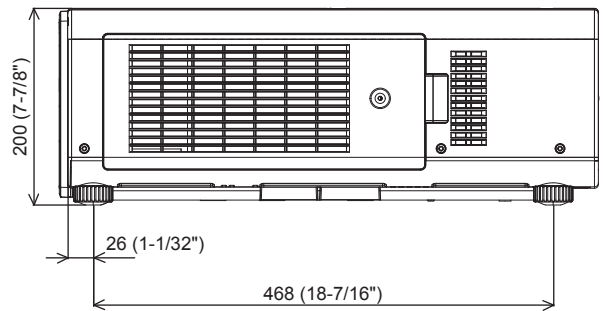
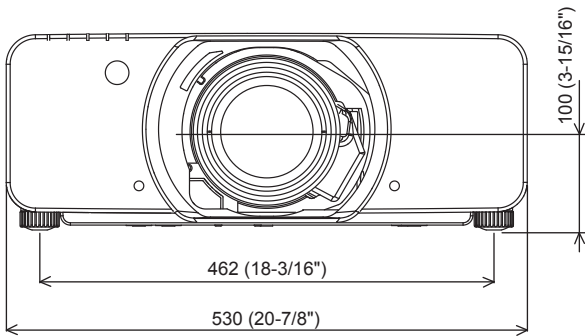
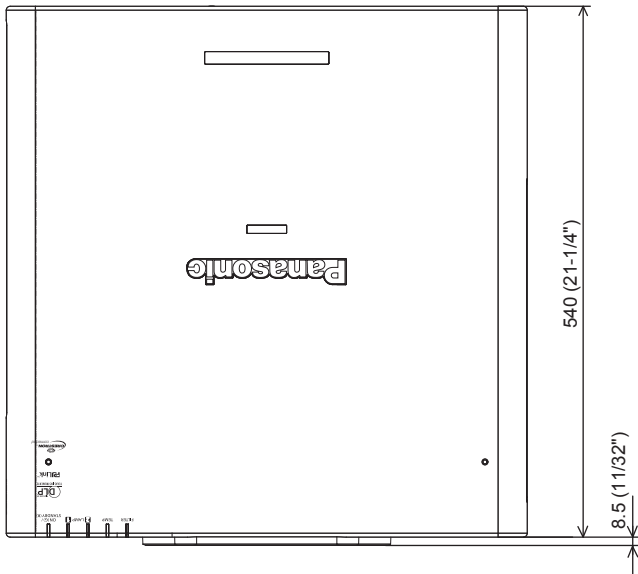

* Actual dimensions may differ depending on the product.

Precautions for Ceiling Mount Bracket for Projectors

- When installing the projector to a ceiling, be sure to use the specified optional Ceiling Mount Bracket for Projectors (Model No.: ET-PKD310H (for High Ceilings), ET-PKD310S (for Low Ceilings), ET-PAD310 (Projector ceiling mount bracket)).
- When installing the projector, attach the drop-prevention kit included with the Ceiling Mount Bracket for Projectors.
- Ask a qualified technician to do the installation work such as mounting the projector on the ceiling.
- Panasonic takes no responsibility for any damage to the projector resulting from use of a ceiling mount bracket not manufactured by Panasonic or the inappropriate choice of location for installation, even if the warranty period of the projector has not expired.
- Unused products must be removed promptly by a qualified technician.
- Use a torque screwdriver or Allen torque wrench to tighten bolts to their specified tightening torques. Do not use electric screwdrivers or impact screwdrivers.
- Read the Installation Instructions for the Ceiling Mount Bracket for Projectors for details.
- The model numbers of accessories and optional accessories are subject to change without prior notice.

Bottom view

Model No. of Ceiling Mount Bracket for Projectors: ET-PKD310H (for High Ceilings)
ET-PKD310S (for Low Ceilings)
ET-PAD310 (Projector ceiling mount bracket)

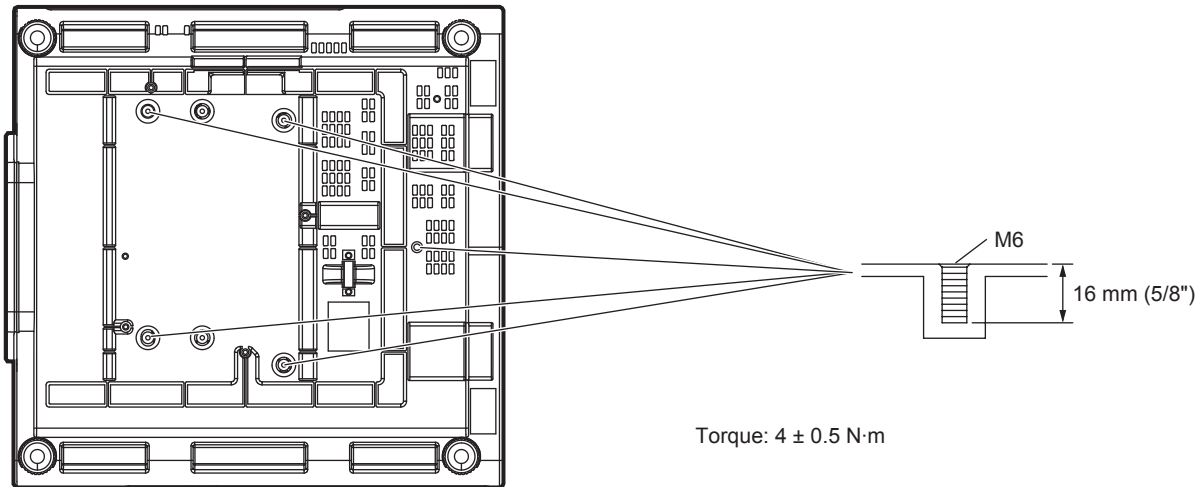

Index

- 0 – 9**
- [3D COLOR MATCHING] 93
 - [3D FRAME DELAY] 94
 - [3D INPUT FORMAT] 92
 - [3D PICTURE BALANCE] 93
 - [3D SAFETY PRECAUTIONS] 95
 - [3D SETTINGS] 68, 91
 - [3D SIMUL INPUT SETTING] 92
 - [3D SYNC SETTING] 91
 - [3D SYSTEM SETTING] 91
 - [3D TEST MODE] 94
 - [3D TEST PATTERN] 95
- A**
- Accessories 20
 - <AC IN> terminal 26, 52
 - Adjusting adjustable feet 45
 - [ADVANCED MENU] 67, 85
 - Air filter unit 158
 - Air filter unit compartment 160
 - Art-Net 18, 168
 - [Art-Net SETUP] 136
 - [ASPECT] 79
 - <ASPECT> button
 - Remote control 24, 63
 - Aspect function 63
 - Attaching/removing the projection lens 46
 - Automatic setup function 62
 - [AUTO SETUP] 98
 - <AUTO SETUP> button
 - Projector body 26, 62
 - Remote control 24, 62
 - [AUTO SIGNAL] 98
- B**
- [BACK COLOR] 103
 - [BLANKING] 85
 - [BRIGHTNESS] 72
 - [BRIGHTNESS CONTROL] 111
- C**
- Cautions on use 18
 - Cautions when installing 16
 - Cautions when transporting 16
 - Ceiling Mount Bracket for Projectors 186
 - [CLAMP POSITION] 86
 - [CLOCK PHASE] 81
 - [COLOR] 72
 - [COLOR MATCHING] 96
 - [COLOR TEMPERATURE] 72
 - Connecting the power cord 52
 - Connecting to the projector with a cable 29
 - Connection 48
 - [CONTRAST] 71
 - [CONTROL DEVICE PASSWORD CHANGE] 133
 - [CONTROL DEVICE SETUP] 132
 - [COOLING CONDITION] 109
 - Crestron RoomView 136, 152
 - [CUT OFF] 107
- D**
- [DARK TIME SETTING] 94
 - [DATE AND TIME] 121
 - <DEFAULT> button
 - Remote control 24, 66
 - Deleting the registered signal 128
 - [DIGITAL CINEMA REALITY] 85
 - Dimensions 185
 - Display language 68, 90
 - [DISPLAY OPTION] 68, 96
 - [DISPLAY SETTING] 132
 - Disposal 18
 - <DVI-D> button
 - Projector body 26, 62
 - Remote control 24
 - [DVI-D IN] 100
 - [DYNAMIC IRIS] 76
- E**
- [EDGE BLENDING] 87
 - <ENTER> button
 - Projector body 26
 - Remote control 24
 - Expanding signal lock-in range 129
- F**
- Filter indicator 156
 - <FOCUS> button
 - Remote control 24, 56
- [FRAME LOCK] 89
- [FRAME RESPONSE] 88
- [FREEZE] 105
- <FUNC> button
 - Remote control 24, 63
- Function button 63
- [FUNCTION BUTTON] 121
- G**
- [GAMMA] 74
 - [GEOMETRY] 81
- H**
- <HDMI> button
 - Projector body 26, 62
 - Remote control 24, 62
 - [HDMI IN] 100
 - [HIGH ALTITUDE MODE] 109
- I**
- <ID ALL> button
 - Remote control 24, 28
 - <ID SET> button
 - Remote control 24, 28
 - [INITIALIZE] 124
 - Initial setting 22
 - [INPUT RESOLUTION] 86
 - Installation mode 31
- K**
- [KEYSTONE] 84
- L**
- Lamp indicator 156
 - [LAMP POWER] 111
 - [LAMP RELAY] 110
 - [LAMP SELECT] 109
 - Lamp unit cover 25
 - [LARGE SCREEN CORRECTION] 97
 - [LEFT/RIGHT SWAP] 93
 - <LENS> button
 - Projector body 26
 - [LENS CALIBRATION] 122
 - [LENS MEMORY] 122
 - <LIGHT> button
 - Remote control 24
 - List of compatible signals 177
 - [LOAD ALL USER DATA] 124
 - <LOCK> button
 - Remote control 24
- M**
- Main menu 66
 - Main power switch 26, 53
 - Maintenance 158
 - <MENU> button
 - Projector body 26, 65
 - Remote control 24, 65
 - Menu item 67
- N**
- Navigating through the menu 65
 - [NETWORK] 70, 135
 - Network connections 136
 - [NETWORK CONTROL] 135
 - [NETWORK SETUP] 135
 - [NETWORK STATUS] 136
 - [NOISE REDUCTION] 76
 - [NO SIGNAL SHUT-OFF] 120
- O**
- <ON SCREEN> button
 - Remote control 24, 61
 - [ON-SCREEN DISPLAY] 102
 - On-screen menu 65
 - Optional accessories 21
- P**
- [PICTURE] 67, 71
 - [PICTURE MODE] 71
 - [P IN P] 69, 125
 - P IN P function 125
 - [POSITION] 67, 79
 - Power cord 52
 - Power indicator 52
 - Power on button
 - Projector body 26
 - Remote control 24
- Power standby button
 - Projector body 26
 - Remote control 24
- Precautions for Ceiling Mount Bracket for Projectors 186
- Precautions for use 16
- Projecting 56
- [PROJECTION METHOD] 108
- Projector body 25
- [PROJECTOR ID] 108
- [PROJECTOR SETUP] 69, 108
- Protecting the registered signal 129
- R**
- [RASTER POSITION] 89
 - Read this first! 2
 - Registering new signals 128
 - <REMOTE 1 IN> terminal 27
 - <REMOTE 1 OUT> terminal 27
 - <REMOTE 2 IN> terminal 175
 - [REMOTE2 MODE] 120
 - Remote control 24
 - Remote control operations 61
 - Renaming the registered signal 128
 - Replacing the air filter unit 160
 - Replacing the lamp unit 160
 - Replacing the unit 160
 - Resetting to the factory default 66
 - <RGB1> button
 - Projector body 26, 62
 - Remote control 24, 62
 - <RGB2> button
 - Projector body 26, 62
 - Remote control 24, 62
 - [RGB IN] 99
 - RoomView 152
 - [RS-232C] 118, 171
- S**
- [SAFETY PRECAUTIONS MESSAGE] 95
 - [SAVE ALL USER DATA] 124
 - [SCHEDULE] 116
 - [SCREEN SETTING] 97
 - <SDI 1/2> button
 - Projector body 26, 62
 - Remote control 24, 62
 - [SDI IN] 100
 - Security 18
 - [SECURITY] 69, 131
 - [SECURITY PASSWORD] 131
 - [SECURITY PASSWORD CHANGE] 131
 - Selecting the input signal 56
 - <SERIAL IN> terminal 171
 - <SERIAL OUT> terminal 171
 - [SERVICE PASSWORD] 124
 - Setting remote control ID numbers 28
 - Setting up 31
 - [SHARPNESS] 75
 - [SHIFT] 79
 - <SHIFT> button
 - Remote control 24, 56
 - <SHUTTER> button
 - Projector body 26, 61
 - Remote control 24, 61
 - [SHUTTER SETTING] 105
 - [SIGNAL LIST] 69, 128
 - Specifications 182
 - sRGB-compliant video 78
 - [STANDBY MODE] 115
 - [STARTUP INPUT SELECT] 117
 - [STARTUP LOGO] 104
 - [STATUS] 119
 - <STATUS> button
 - Remote control 24, 62
 - Sub memory 130
 - Switching off the projector 55
 - Switching on the projector 53
 - Switching the input signal 62
 - [SYSTEM DAYLIGHT VIEW] 75
 - [SYSTEM SELECTOR] 77
- T**
- Temperature indicator 156
 - <TEST> button
 - Remote control 24, 63
 - [TEST PATTERN] 69, 127
 - [TEXT CHANGE] 132
 - [TINT] 72
 - Troubleshooting 164

Two window 176

U

[UNIFORMITY] 104

Upgrade Kit 177

V

<VIDEO> button

Projector body 26, 62

Remote control 24, 62

W

[WAVEFORM MONITOR] 105

Z

[ZOOM] 80

<ZOOM> button

Remote control 24, 56

Information for Users on Collection and Disposal of Old Equipment and used Batteries



These symbols on the products, packaging, and/or accompanying documents mean that used electrical and electronic products and batteries should not be mixed with general household waste. For proper treatment, recovery and recycling of old products and used batteries, please take them to applicable collection points, in accordance with your national legislation and the Directives 2002/96/EC and 2006/66/EC.

By disposing of these products and batteries correctly, you will help to save valuable resources and prevent any potential negative effects on human health and the environment which could otherwise arise from inappropriate waste handling.



For more information about collection and recycling of old products and batteries, please contact your local municipality, your waste disposal service or the point of sale where you purchased the items.

Penalties may be applicable for incorrect disposal of this waste, in accordance with national legislation.



For business users in the European Union

If you wish to discard electrical and electronic equipment, please contact your dealer or supplier for further information.

Information on Disposal in other Countries outside the European Union

These symbols are only valid in the European Union. If you wish to discard these items, please contact your local authorities or dealer and ask for the correct method of disposal.

Note for the battery symbol (bottom two symbol examples):

This symbol might be used in combination with a chemical symbol. In this case it complies with the requirement set by the Directive for the chemical involved.

Environment care information for users in China



This symbol is only valid in China.

Panasonic Corporation

Web Site : <http://panasonic.net/avc/projector/>

© Panasonic Corporation 2013

W0513HM2064 -YI