

The Samsung logo is displayed in white, bold, uppercase letters inside a dark grey, horizontally-oriented oval shape.

SAMSUNG

HW-J550

HW-J551

User manual

Wireless Audio - Soundbar

Imagine the possibilities

Thank you for purchasing this Samsung product.
To receive more complete service, please register your product at
www.samsung.com/register

FEATURES

TV SoundConnect

TV SoundConnect lets you listen to audio from your TV on your Soundbar via a Bluetooth connection and lets you control the sound.

HDMI

HDMI transmits video and audio signals simultaneously, and provides a clearer picture.

The unit is also equipped with the ARC function which lets you listen to sound from your TV through the Soundbar via an HDMI cable. This function is only available if you connect the unit to an ARC compliant TV.

SURROUND SOUND

The SURROUND SOUND feature adds depth and spaciousness to your listening experience.

Wireless Subwoofer

Samsung's wireless module does away with cables running between the main unit and the subwoofer.

Instead, the subwoofer connects to a compact wireless module that communicates with the main unit.

Special Sound Effects

You can select different Sound Effects - STANDARD (Original Sound)/MUSIC / VOICE / SPORTS / CINEMA / NIGHT MODE - depending on the type of content you want to enjoy.

Multi-function Remote Control

You can use the supplied remote control to control various operations with the simple press of a button.

USB Host Support

You can connect and play music files from external USB storage devices such as MP3 players, USB flash memory, etc. using the Soundbar's USB HOST function.

Bluetooth Function

You can connect a Bluetooth device to the Soundbar and enjoy music with high quality stereo sound, all without wires!

Using the Samsung Audio Remote App

To control the product with your Smart Device via the Samsung Audio Remote app, download the Samsung Audio Remote App by accessing the app through Google Play store.

LICENSES



Manufactured under license from Dolby Laboratories. Dolby and the double-D symbol are trademarks of Dolby Laboratories.



For DTS patents, see <http://patents.dts.com>. Manufactured under license from DTS Licensing Limited. DTS, the Symbol, & DTS and the Symbol together are registered trademarks, and DTS 2.0 Channel is a trademark of DTS, Inc. © DTS, Inc. All Rights Reserved.



HDMI

The terms HDMI and HDMI High-Definition Multimedia Interface, and the HDMI Logo are trademarks or registered trademarks of HDMI Licensing LLC in the United States and other countries.

SAFETY INFORMATION

SAFETY WARNINGS

TO REDUCE THE RISK OF ELECTRIC SHOCK, DO NOT REMOVE THE COVER (OR BACK). NO USER-SERVICEABLE PARTS ARE INSIDE. REFER SERVICING TO QUALIFIED SERVICE PERSONNEL.

<div style="background-color: black; color: white; padding: 5px; text-align: center; font-weight: bold;">CAUTION</div> <div style="border: 1px solid black; padding: 5px; text-align: center;">RISK OF ELECTRIC SHOCK. DO NOT OPEN.</div>		The lightning flash and arrowhead within the triangle indicates that there is dangerous voltage inside the product.
<p>CAUTION: TO REDUCE THE RISK OF ELECTRIC SHOCK, DO NOT REMOVE THE COVER (OR BACK). NO USER-SERVICEABLE PARTS INSIDE. REFER SERVICING TO QUALIFIED SERVICE PERSONNEL.</p>		The exclamation point within the triangle indicates that there are important instructions accompanying the product.

WARNING

- To reduce the risk of fire or electric shock, do not expose this appliance to rain or moisture.
- To prevent injury, this apparatus must be securely attached to the floor/wall in accordance with the installation instructions.
- This product contains chemicals known to the State of California to cause cancer and reproductive toxicity.

CAUTION

- Do not expose this apparatus to dripping or splashing. Do not put objects filled with liquids, such as vases on the apparatus.
- To turn this apparatus off completely, you must pull the power plug out of the wall socket. Consequently, the power plug must be easily and readily accessible at all times.

This Class B digital apparatus complies with Canadian ICES-003.

This device complies with Industry Canada license exempt RSS standard(s). Operation is subject to the following two conditions: (1) this device may not cause interference, and (2) this device must accept any interference, including interference that may cause undesired operation of the device.

Important Safety Instructions

Read these operating instructions carefully before using the unit. Follow all the safety instructions listed below. Keep these operating instructions handy for future reference.

- 1) Read these instructions.
- 2) Keep these Instructions.
- 3) Heed all warnings.
- 4) Follow all instructions.
- 5) Do not use this apparatus near water.
- 6) Clean only with dry cloth.
- 7) Do not block any ventilation openings. Install in accordance with the manufacturer's instructions.
- 8) Do not install near any heat sources such as radiators, heat registers, stoves, or other apparatus (including amplifiers) that produce heat.
- 9) Do not defeat the safety purpose of the polarized or grounding-type plug. A polarized plug has two blades with one wider than the other. A grounding type plug has two blades and a third grounding prong. The wide blade or the third prong are provided for your safety. If the provided plug does not fit into your outlet, consult an electrician for replacement of the obsolete outlet.
- 10) Protect the power cord from being walked on or pinched particularly at plugs, convenience receptacles, and the point where they exit from the apparatus.
- 11) Only use attachment/accessories specified by the manufacturer.
- 12) Use only with the cart, stand, tripod, bracket, or table specified by the manufacturer, or sold with the apparatus. When a cart is used, use caution when moving the cart/apparatus combination to avoid injury from tip-over.
- 13) Unplug this apparatus during lightning storms or when unused for long periods of time.
- 14) Refer all servicing to qualified service personnel. Servicing is required when the apparatus has been damaged in any way, such as when the power-supply cord or plug is damaged, liquid has been spilled or objects have fallen into the apparatus, the apparatus has been exposed to rain or moisture, does not operate normally, or has been dropped.



PRECAUTIONS

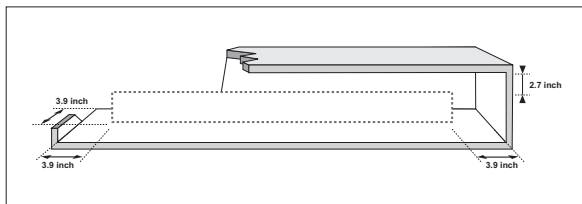

Ensure that the AC power supply in your house complies with the power requirements listed on the identification sticker located on the back of your product. Install your product horizontally, on a suitable base (furniture), with enough space around it for ventilation (3–4 inches). Make sure the ventilation slots are not covered. Do not place the unit on amplifiers or other equipment which may become hot. This unit is designed for continuous use. To fully turn off the unit, disconnect the AC plug from the wall outlet. Unplug the unit if you intend to leave it unused for a long period of time.

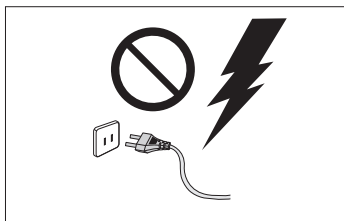

During thunderstorms, disconnect the AC plug from the wall outlet. Voltage peaks due to lightning could damage the unit.

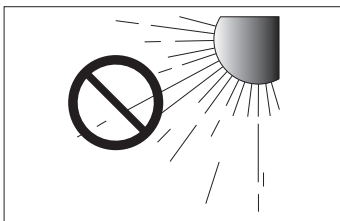

Do not expose the unit to direct sunlight or other heat sources. This could lead to overheating and cause the unit to malfunction.

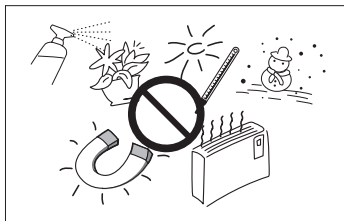

Protect the product from moisture (i.e. vases), and excess heat (e.g. a fireplace) or equipment creating strong magnetic or electric fields. Unplug the power cable from the AC wall socket if the unit malfunctions. Your product is not intended for industrial use. It is for personal use only. Condensation may occur if your product has been stored in cold temperatures. If transporting the unit during the winter, wait approximately 2 hours until the unit has reached room temperature before using.

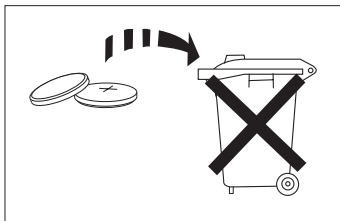

The battery used with this product contains chemicals that are harmful to the environment. Do not dispose of battery in the general household trash. Do not expose the battery to excess heat, direct sunlight, or fire. Do not short circuit, disassemble, or overheat the battery. Danger of explosion if the battery is replaced incorrectly. Replace only with the same or equivalent type.

CONTENTS

2 FEATURES

- 2 Licenses

3 SAFETY INFORMATION

- 3 Safety Warnings
- 4 Precautions

6 GETTING STARTED

- 6 Before reading the User's Manual
- 6 What's Included

7 DESCRIPTIONS

- 7 Top/Front Panel
- 8 Rear Panel

9 REMOTE CONTROL

- 9 Remote Control Buttons and Functions

11 CONNECTIONS

- 11 Installing the Wall Mount
- 12 Detaching the Wall Mount
- 13 Installing the bracket without referring to the Wall-mount Installation Guide
- 14 Connecting the Wireless Subwoofer
- 15 Connecting an External Device using an HDMI cable
- 16 Connecting an External Device using Audio (analog) cable or Optical (digital) cable

17 FUNCTIONS

- 17 Input mode
- 17 ARC (HDMI OUT)
- 18 Bluetooth
- 20 Using The Samsung Audio Remote App
- 21 TV SoundConnect
- 22 USB
- 23 Software Update

24 TROUBLESHOOTING

25 APPENDIX

- 25 Specifications



- Figures and illustrations in this User Manual are provided for reference only and may differ from actual product appearance.
- An administration fee may be charged if either
 - (a) An engineer is called out at your request and there is no defect with the product (i.e. where the user manual has not been read).
 - (b) You bring the unit to a repair centre and there is no defect with the product (i.e. where the user manual has not been read).
- You will be informed of the administration fee amount before a technician visits.

GETTING STARTED

BEFORE READING THE USER'S MANUAL

Note the following terms before reading the user manual.

► Icons used in this manual

Icon	Term	Definition
	Caution	Indicates a situation where a function does not operate or settings may be canceled.
	Note	Indicates tips or instructions on the page that help you operate a function.

► Safety Instructions and Troubleshooting

- 1) Be sure to familiarize yourself with the Safety Instructions before using this product. (See page 3)
- 2) If a problem occurs, check Troubleshooting. (See page 24)

► Copyright

©2015 Samsung Electronics Co.,Ltd.

All rights reserved; no part of this user's manual may be reproduced or copied without the prior written permission of Samsung Electronics Co.,Ltd.

WHAT'S INCLUDED

Check for the supplied accessories shown below.

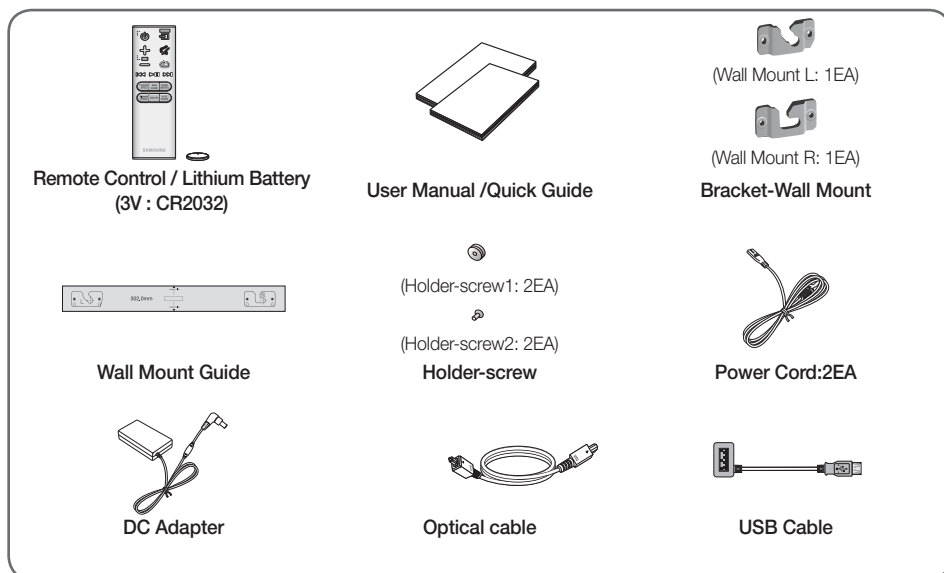

- The appearance of the accessories may differ slightly from the illustrations above.
- Use the dedicated USB cable to connect external USB devices to the unit.

DESCRIPTIONS

TOP/FRONT PANEL

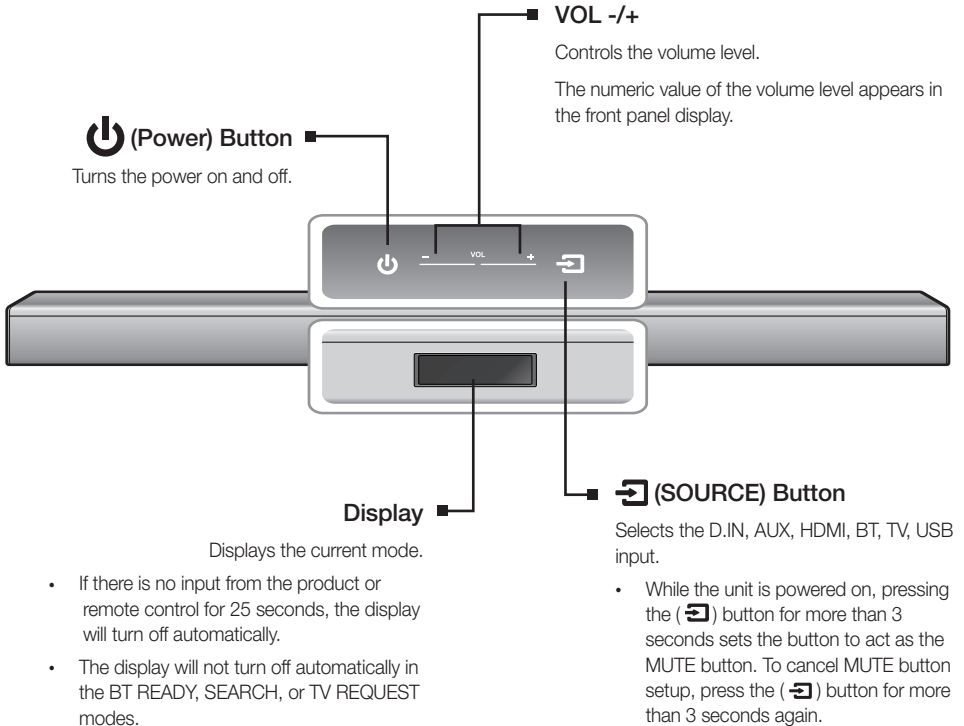

- When you turn on this unit, there will be a 4 to 5 second delay before it produces sound.
- If you want to enjoy sound only from the Soundbar, you must turn off the TV's speakers in the Audio Setup menu of your TV. Refer to the owner's manual supplied with your TV.

REAR PANEL

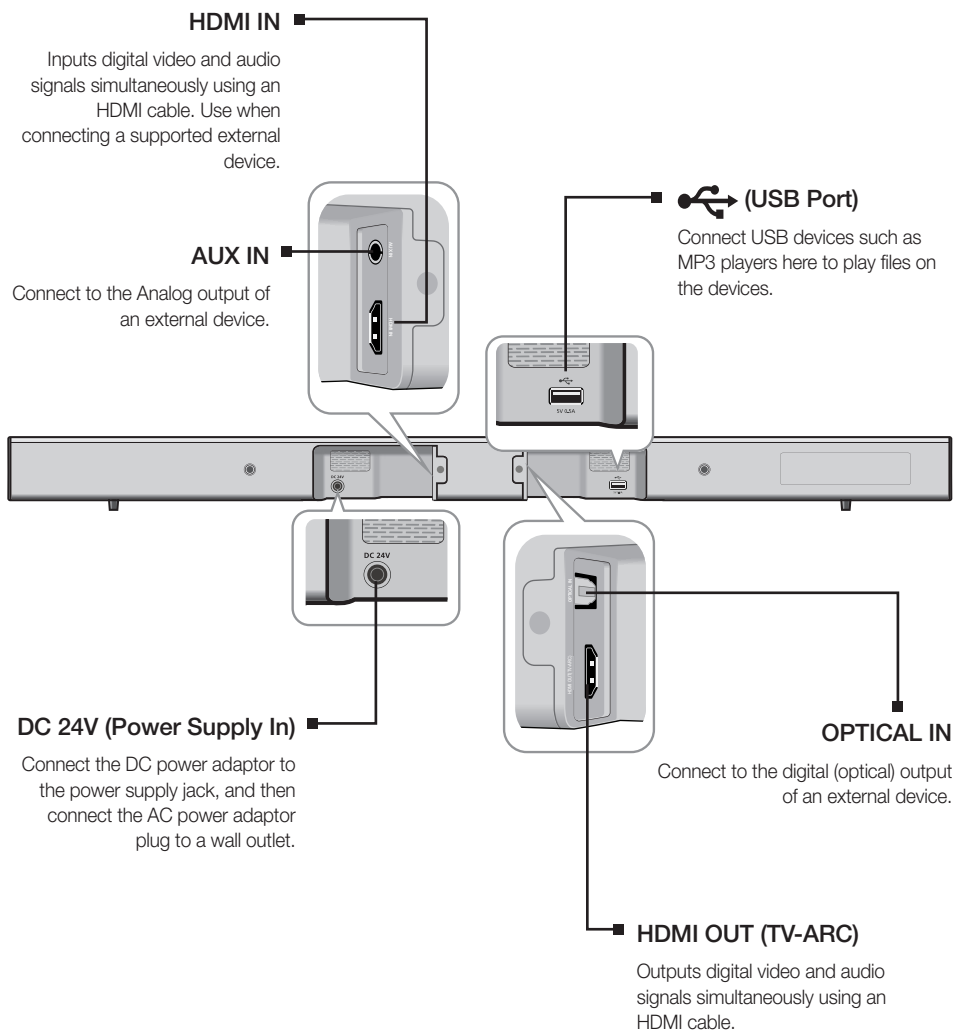

- When disconnecting the power cable of the AC power adaptor from the wall outlet, pull the plug. Do not pull the cable.
- Do not connect this unit or other components to an AC outlet until all connections between components are complete.

REMOTE CONTROL

REMOTE CONTROL BUTTONS AND FUNCTIONS

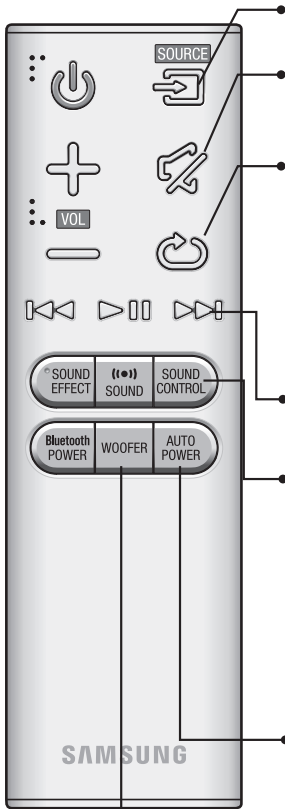

SOURCE

Press to select a source connected to the Soundbar.

MUTE

You can turn the volume down to 0 with the push of a button. Press again to restore the sound to the previous volume level.

REPEAT

Press to set the REPEAT function during music playback from a USB device.

OFF-REPEAT : Cancels Repeat Playback.

TRACK-REPEAT : Repeatedly play a track.

ALL-REPEAT : Repeatedly play all tracks.

RANDOM-REPEAT : Plays tracks in random order. (A track that has already been played may be played again.)

Skip Forward

If there is more than one file on the device you are playing, and you press the **▶▶** button, the next file is selected.

SOUND CONTROL

Press to select **TREBLE**, **BASS**, or **AUDIO SYNC**. Then, use the **◀◀, ▶▶** buttons to adjust the Treble, Bass volume from -6 to +6.

If the Soundbar is connected to a digital TV and the video appears out of sync with the audio, press the **SOUND CONTROL** button to sync the audio with the video. Use the **◀◀, ▶▶** buttons to set the audio delay between 0 ms and 300 ms. In USB mode, TV mode, and BT mode, the Audio Sync function may not work.

Press and hold the **SOUND CONTROL** button for about 5 seconds to adjust the sound for each frequency band. 150Hz, 300Hz, 600Hz, 1.2KHz, 2.5KHz, 5KHz and 10KHz are selectable and each can be adjusted to a setting between -6 and +6.

AUTO POWER

Auto Power Link: Synchronizes the Soundbar to a connected Optical source via the Optical jack so it turns on automatically when you turn on your TV.

(Auto Power Link : Default OFF, ON-ANYNET+ / OFF-POWER LINK or OFF-ANYNET+ / ON-POWER LINK). The Anynet+ function lets you control the Soundbar with the remote from an Anynet+ compatible Samsung TV. The Soundbar must be connected to the TV via an HDMI cable.

* Anynet+: Press the **AUTO POWER** button to turn the Anynet+ function on or off.

WOOFER

You can control the woofer volume.

Press the Woofer button, and then press the **◀◀, ▶▶** button to increase or decrease the subwoofer volume. You can select SW (-12, -6, -5, -4, -3, -2, -1, 0, +1, +2, +3, +4, +5, +6).



- Soundbar is a Samsung proprietary name.
- Operate the TV using the TV's remote control.

POWER
Turns the Soundbar on and off.

VOLUME
Adjusts the volume level of the unit.

Play/Pause
Press the ►|| button to pause a file temporarily.
Press the ►|| button again to play the selected file.

Skip Back
If there is more than one file on the device you are playing, and you press the ◀◀ button, the previous file is selected.

SOUND EFFECT
You can select different sound modes - **STANDARD, MUSIC, VOICE, SPORTS, CINEMA, and NIGHT MODE** - depending on the type of sources you want to enjoy.
Press the **SOUND EFFECT** button on the remote control.
Select the **STANDARD** mode if you want to enjoy the original sound.
* Night Mode
Night Mode prevents drastic volume level changes when you change a channel or there is a scene transition.

Bluetooth POWER
Press the **Bluetooth POWER** button on the remote to turn the Bluetooth POWER on function on and off.
See pages 19 and 21 for details.

SOUND
Press the **SOUND** button on the remote to add depth and spaciousness to the sound.
Each time the button is pressed, the selection changes as follows :
OFF-SURROUND SOUND → ON-SURROUND SOUND

► Installing the Battery in the Remote Control

1. Use a suitable coin to turn the remote control's battery cover counterclockwise to remove it as shown in the figure above.
2. Insert a 3V lithium battery. Keep the positive (+) pole facing up when inserting the battery. Put the battery cover on and align the '•' marks side by side as shown in the figure above.
3. Use a suitable coin to turn the remote control battery cover clockwise as far as it will go to fix it in place.

CONNECTIONS

INSTALLING THE WALL MOUNT

You can use the wall mount bracket to mount this unit on a wall.

► Installation Precautions

- Install on a vertical wall only.
- For the installation, avoid a location with high temperature or humidity, or a wall that cannot sustain the weight of the set.
- Check the strength of the wall. If the wall is not strong enough to support the unit, reinforce the wall or install the unit on a different wall that can support the unit's weight.
- Purchase and use the fixing screws or anchors appropriate for the kind of wall you have (plaster board, iron board, wood, etc.). If possible, screw the support screws into wall studs.
- Purchase wall mounting screws according to the type and thickness of the wall you will mount the Soundbar on.
 - Diameter : M5
 - Length: 1 3/8 inches (35 mm) or longer recommended.
- Connect cables from the unit to external devices before you install it on the wall.
- Make sure the unit is turned off and unplugged before you install it. Otherwise, it may cause an electric shock.

To install the Soundbar on a wall, follow these steps:

1. Place the installation guide against the wall surface.
 - The installation guide must be level.
 - If the TV is mounted on the wall, install the Soundbar at least 2 inches (5 cm) below the TV.
2. Mark the location where the screws will go through on the wall, and then remove the installation guide. Next, drill holes for the screws using an appropriately sized drill bit.
3. Fasten the wall mounts and screws to the marked locations.
 - The left and right mounts are different shapes. Make sure to position them correctly.
4. Secure the two holder screws to the screw holes on the back of the Soundbar's main body, one on the left and one on the right.
5. Insert the USB cable into the back of the Soundbar before installing it on the wall.
6. Set the holder screws on the back of the Soundbar into the grooves of the wall mounts. For safe installation, make sure to push the holder screws all the way to the bottom of the grooves.

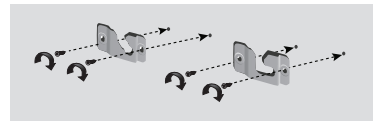
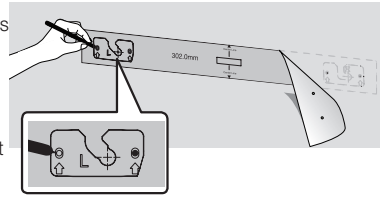
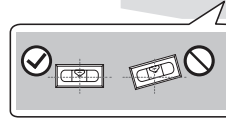

Wall Mounting the Soundbar

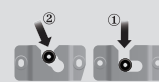

DETACHING THE WALL MOUNT

1. Pull the Soundbar upwards as shown in the figure to separate it from the wall mounts.

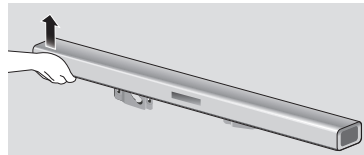

Detaching the Soundbar from the Wall Mounts



- Do not hang onto the installed unit and avoid striking or dropping the unit.
- Secure the unit firmly to the wall so that it does not fall off. If the unit falls off, it may cause an injury or damage the product.
- When the unit is installed on a wall, please make sure that children do not pull any of the connecting cables, as it may cause it to fall.
- For the optimal performance of a wall mount installation, install the speaker system at least 2 inches (5 cm) below the TV, if the TV is mounted on the wall.
- For your safety, if you do not mount the unit on the wall, install it on a secure, flat surface where it is unlikely to fall.

INSTALLING THE BRACKET WITHOUT REFERRING TO THE WALL-MOUNT INSTALLATION GUIDE

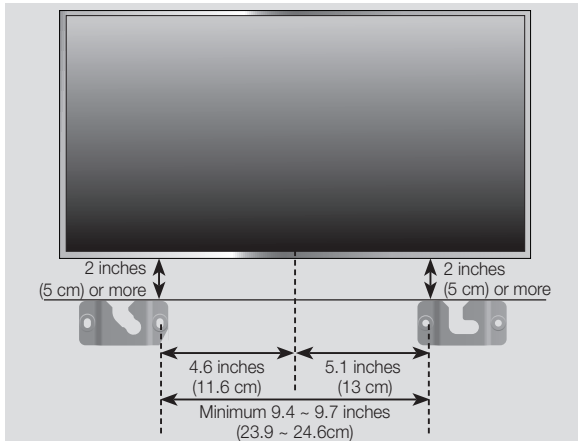

1. Place Wall Mount L on the desired wall surface parallel to the floor as shown above. Mark the location of the screw holes on the wall. Drill holes for the screws at the places you have marked.
2. Match the screw holes on Wall Mount L to the screw holes on the wall, and then screw one screw through the hole in its right end. Tighten the screw until it is firmly fixed to the wall.
3. Place Wall Mount R on the desired wall surface parallel to the floor and aligned with Wall Mount L as shown above. Mark the location of the screw holes on the wall. Drill holes for the screws at the places you have marked.
4. Match the screw holes on Wall Mount R to the screw holes on the wall, and then screw one screw through the hole in its right end. Tighten the screw until it is firmly fixed to the wall.
 - If you are mounting the Wall Mounts beneath the TV, make sure to position the mounts 2 or more inches below the TV and to align the mounts with the center of the TV as shown above.
5. Insert screws through the remaining holes, and then tighten.

CONNECTING THE WIRELESS SUBWOOFER

The Subwoofer's linking ID is preset at the factory and the main unit and subwoofer should link (connect wirelessly) automatically when the main unit and subwoofer are turned on. If the Link indicator (📶) does not light when the main unit and subwoofer are turned on, please set the ID by following the procedure below.

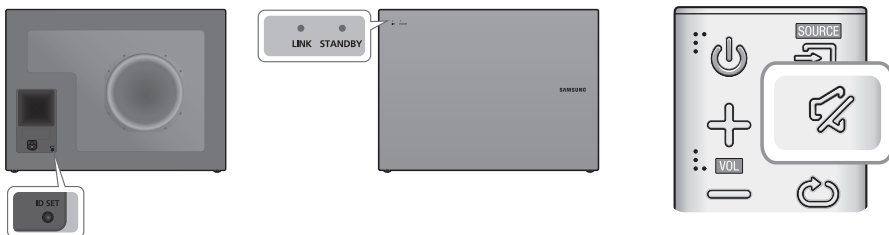

1. Plug the power cords of the main unit and subwoofer into an AC wall outlet.
 2. Press the **ID SET** button on the back of the subwoofer with a small, pointed object for 5 seconds.
 - The STANDBY indicator is turned off and the LINK indicator (Blue LED) blinks quickly.
 3. While the main unit is powered off (in STANDBY mode), press and hold the  (Mute) on the remote control for 5 seconds.
 4. The **ID SET** message appears on the Soundbar's display.
 5. To finalize the link, turn the main unit's power on while the subwoofer's Blue LED blinks.
 - The main unit and the subwoofer should now be linked (connected).
 - The Link indicator (Blue LED) on the subwoofer should be on.
 - If the Link indicator is not solid blue, the linking process has failed. Turn off the main unit and start again from Step 2.
 - You can enjoy better sound from the wireless subwoofer by selecting a Sound Effect. (See page 10)
- If the main unit is powered off, the wireless subwoofer will be in standby mode and the STANDBY LED on the upper side will come on after the Link indicator (Blue LED) blinks for 30 seconds.
 - If you use a device that uses the same frequency (2.4GHz) as the Soundbar near the Soundbar, interference may cause some sound interruption.
 - The maximum transmission distance of the wireless signal between the main unit and subwoofer is about 33 ft, but may vary depending on your operating environment. If a steel-concrete or metallic wall is between the main unit and the wireless subwoofer, the system may not operate at all, because the wireless signal cannot penetrate metal.
 - If the main unit doesn't make a wireless connection, follow steps 1-5 in the left hand column to re-set the connection between the main unit and wireless subwoofer.



- The wireless receiving antenna is built into the wireless subwoofer. Keep the unit away from water and moisture.
- For optimal listening performance, make sure that the area around the wireless subwoofer location is clear of any obstructions.



- Before moving or installing the product, be sure to turn off the power and disconnect the power cord.

CONNECTING AN EXTERNAL DEVICE USING AN HDMI CABLE

HDMI is the standard digital interface for connecting to TVs, projectors, DVD players, Blu-ray players, set top boxes, and more.

HDMI prevents any degradation to the signal due to conversion to analog and maintains the video and audio quality of the original digital source.

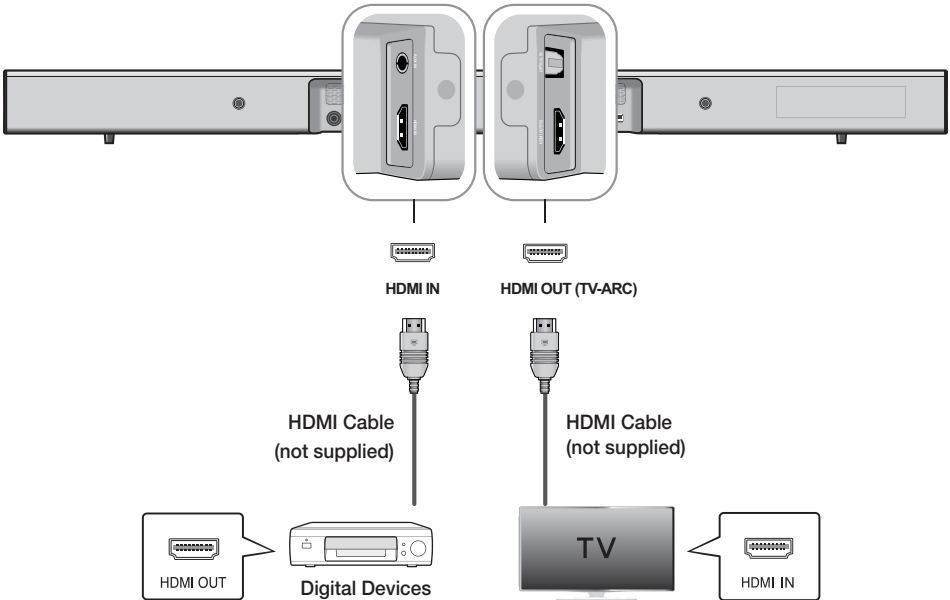

HDMI IN

Connect an HDMI cable (not supplied) from the **HDMI IN** jack on the back of the product to the HDMI OUT jack on your digital device.

and,

HDMI OUT (TV)

Connect an HDMI cable (not supplied) from the **HDMI OUT (TV-ARC)** jack on the back of the product to the HDMI IN jack on your TV.

HDMI OUT (ARC)

The ARC function allows digital audio to output via the **HDMI OUT (ARC)** port.

It can be enabled only when the Soundbar is connected to a TV that supports the ARC function

- HDMI is an interface that enables the digital transmission of video and audio data with just a single connector.

- Anynet+ must be turned on.
- This function is not available if the HDMI cable does not support ARC.

CONNECTING AN EXTERNAL DEVICE USING AUDIO (ANALOG) CABLE OR OPTICAL (DIGITAL) CABLE

This unit comes equipped with one digital optical in jack and one analog audio in jack (Aux In), giving you two ways to connect it to a TV.

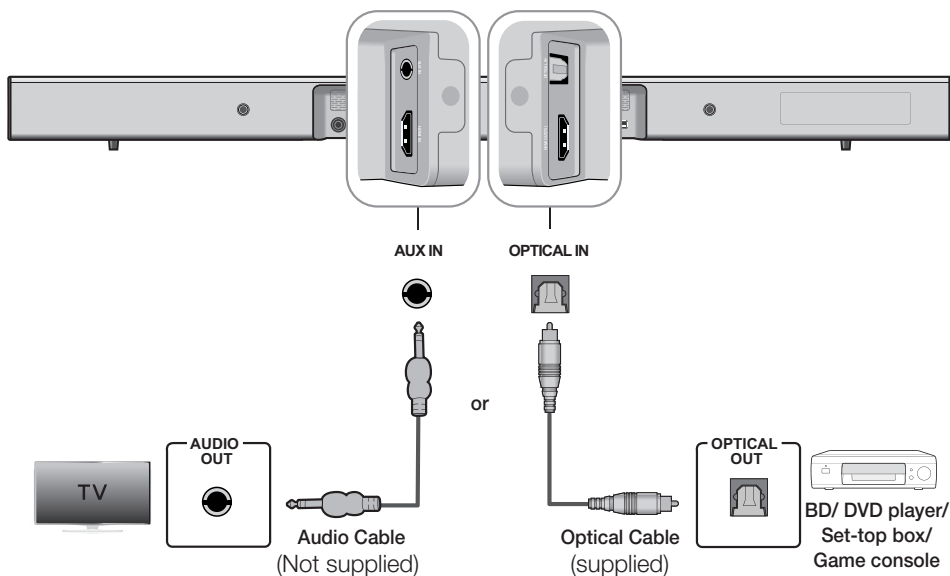

AUX IN

Connect **AUX IN** (Audio) on the main unit to the AUDIO OUT jack of the TV or Source Device. To use, change the function to **AUX**.

or,

OPTICAL IN



Connect **OPTICAL IN** (Audio) on the main unit to the OPTICAL OUT jack of the TV or Source Device. To use, change the function to **D.IN**.



- Do not connect the power cord of this product or your TV to the wall outlet until all connections between components are complete.
- Before moving or installing this product, be sure to turn off the power and disconnect the power cord.

FUNCTIONS

INPUT MODE

Press the () button on the main unit's top panel or the () (SOURCE) button on the remote control to select the mode you want.

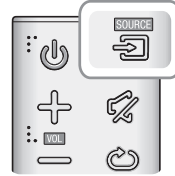

Input mode	Display
Optical Digital input	D.IN
AUX input	AUX
HDMI input	HDMI
BLUETOOTH mode	BT
TV SoundConnect	TV
USB mode	USB

The unit turns off automatically in the following situations.



- D.IN/HDMI/BT/TV/USB Mode
 - If there is no audio signal for 25 minutes.
- AUX Mode
 - If the AUX cable is disconnected for 25 minutes.
 - In Auto Power Down ON mode, if there is no KEY input for 8 hours when the AUX cable is connected.
 - To turn the Auto Power Down function ON or OFF, press and hold the  button for 5 seconds. OFF/ON-AUTO POWER DOWN appears on the display.

ARC (HDMI OUT)

ARC (Audio Return Channel) transmits the digital audio signal to the HDMI OUT (ARC) port.



(Not supplied)

1. Connect a TV supporting ARC to the Soundbar with an HDMI cable.
2. Turn on the TV, turn on the Soundbar, and then turn on the Soundbar's Anynet+ function.
3. Press the () button on the main unit's top panel or the () (SOURCE) button on the remote control to select the **D.IN** mode.



- If the HDMI cable does not support the ARC function, ARC will not work.
- To turn off the ARC function, turn Anynet+ off.



BLUETOOTH

You can connect a Bluetooth device to the Soundbar and enjoy music with high quality stereo sound, all without wires!

► To connect the Soundbar to a Bluetooth device

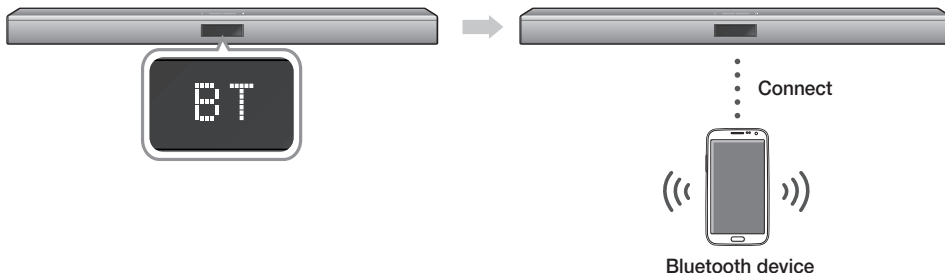
Check if the Bluetooth device supports the Bluetooth compliant stereo headset function.



- Press the () button on the main unit's top panel or the  (SOURCE) button on the remote control to select the **BT** mode.
 - You will see BT READY on the front display of the Soundbar.
- Select the Bluetooth menu on the Bluetooth device you want to connect. (Refer to the Bluetooth device's user manual.)
- Select the Stereo headset menu on the Bluetooth device.
 - You will see a list of scanned devices.
- Select "[Samsung] Soundbar J-Series" from the list.
 - When the Soundbar is connected to the Bluetooth device, it will display [Bluetooth device name] → BT on the front display.
 - The device name can only be displayed in English. An underline " _ " will be displayed if the name is not in English.
 - If the Bluetooth device has failed to pair with the Soundbar, delete the previous "[Samsung] Soundbar J-Series" found by the Bluetooth device and have it search for the Soundbar again.
- Play music on the connected device.
 - You can listen to the music playing on the connected Bluetooth device over the Soundbar. In BT mode, the Play/Pause/Next/Prev functions are not available. However, these functions are available in Bluetooth devices supporting AVRCP.



- If asked for a PIN code when connecting a Bluetooth device, enter <0000>.
- Only one Bluetooth device can be paired at a time.
- The Bluetooth connection will be terminated when you turn the Soundbar off.
- The Soundbar may not perform Bluetooth search or connection correctly under the following circumstances:
 - If there is a strong electrical field around the Soundbar.
 - If several Bluetooth devices are simultaneously paired with the Soundbar.
 - If the Bluetooth device is turned off, not in place, or malfunctions.
- Note that such devices as microwave ovens, wireless LAN adaptors, fluorescent lights, and gas stoves use the same frequency range as the Bluetooth device, which can cause electric interference.
- The Soundbar supports SBC data (44.1kHz, 48kHz).
- Connect only to a Bluetooth device that supports the A2DP (AV) function.
- You cannot connect the Soundbar to a Bluetooth device that supports only the HF (Hands Free) function.
- Once paired the device, on D.IN/AUX/ HDMI/ USB/TV mode, select "[Samsung] Soundbar J-Series" from the list will automatically change to BT mode.

► Bluetooth POWER on (Bluetooth POWER)

When the Bluetooth Power On function is on and the Soundbar is turned off, if a previously paired Bluetooth device tries to pair with the Soundbar, the Soundbar turns on automatically.

1. To turn Bluetooth Power ON, press the **Bluetooth POWER** button on the remote while the Soundbar is turned on.
2. ON-Bluetooth POWER appears on the Soundbar's display.



- Available only if the Soundbar is listed among the Bluetooth device's paired devices. (The Bluetooth device and the Soundbar must have been previously paired at least once.)
- Soundbar will appear in the Bluetooth device's searched devices list only when the Soundbar is displaying [BT READY].
- In the TV SoundConnect mode, the Soundbar cannot be paired to another Bluetooth device.

► To disconnect the Bluetooth device from the Soundbar

You can disconnect the Bluetooth device from the Soundbar. For instructions, see the Bluetooth device's user manual.

- The Soundbar will be disconnected.
- When the Soundbar is disconnected from the Bluetooth device, the Soundbar will display BT DISCONNECTED on the front display.

► To disconnect the Soundbar from the Bluetooth device

Press the  (SOURCE) button on the remote control or the () button on the product's top panel to switch from BT to another mode or turn off the Soundbar.

- The connected Bluetooth device will wait a certain amount of time for a response from the Soundbar before terminating the connection. (Disconnection time may differ, depending on the Bluetooth device)



- In Bluetooth connection mode, the Bluetooth connection will be lost if the distance between the Soundbar and the Bluetooth device exceeds 16.25 ft. (5m).
- The Soundbar automatically turns off after 25 minutes in the Ready state.

More About Bluetooth

Bluetooth is a technology that enables Bluetooth-compliant devices to interconnect easily with each other using a short wireless connection.

- A Bluetooth device may cause noise or malfunction, depending on usage, if:
 - A part of your body is in contact with the receiving/transmitting system of the Bluetooth device or the Soundbar.
 - It is subject to electrical variation from obstructions caused by a wall, corner, or office partition.
 - It is exposed to electrical interference from same frequency-band devices including medical equipment, microwave ovens, and wireless LANs.
- Pair the Soundbar with the Bluetooth device while they are close together.
- The further the distance between the Soundbar and Bluetooth device, the worse the quality is. If the distance exceeds the Bluetooth operational range, the connection is lost.
- In poor reception areas, the Bluetooth connection may not work properly.
- The Bluetooth connection only works when it is close to the unit. The connection will be automatically cut off if the Bluetooth device is out of range. Even within range, the sound quality may be degraded by obstacles such as walls or doors.
- This wireless device may cause electric interference during its operation.

USING THE SAMSUNG AUDIO REMOTE APP

Installing the Samsung Audio Remote App

To control the product with your Smart Device via the Samsung Audio Remote app, download the Samsung Audio Remote App by accessing the app through Google Play store.



Starting the Samsung Audio Remote App

After you install the Samsung Audio Remote app, follow the instructions in the app.

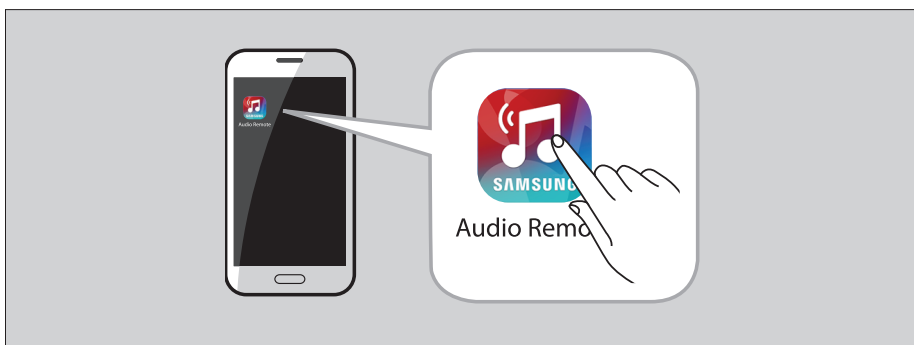

- The Samsung Audio Remote APP is only supported on phones running Android OS 3.0 or above.

TV SOUNDCONNECT

You can enjoy TV sound through your Soundbar when it is connected to a Samsung TV that supports the TV SoundConnect function.

► Connecting a TV to the Soundbar

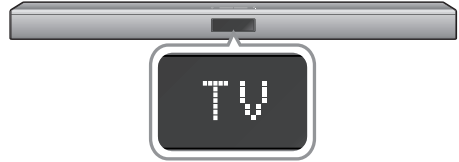

- Turn on the TV and Soundbar.
 - Open the menu of the TV.
 - Move to Speaker Settings on the "Sound" tab.
 - Set the "Add New Device" menu to "On".
- Press the (↩) button on the main unit's top panel or the (SOURCE) button on the remote control to select the TV mode.
- On the TV, a message asking whether to enable the TV SoundConnect function appears. "[Samsung] Soundbar" is displayed on the TV screen.
- Select <Yes> using the TV remote to finish connecting the TV and Soundbar.



- Switching the Soundbar's mode from TV to another mode automatically terminates TV SoundConnect.
- To connect the Soundbar to another TV, the existing connection must be terminated.
- To terminate the existing connection, press and hold the ►|| button on the remote for 5 seconds or switch to another mode. To connect to the other TV, follow Steps 1 through 4 above.



- The TV SoundConnect (SoundShare) function is supported by some Samsung TVs released from 2012 on. Check whether your TV supports the TV SoundConnect (SoundShare) function before you begin. (For further information, refer to the TV's user manual.)
- If your Samsung TV was released before 2014, check the SoundShare setting menu.

- If the distance between the TV and Soundbar exceeds 16.25 ft. (5m), the connection may not be stable or the audio may stutter. If this occurs, relocate the TV or Soundbar so that they are within operational range, and then re-establish the TV SoundConnect connection.



- TV SoundConnect Operational Ranges:
 - Recommended pairing range: within 20 inches (within 50cm)
 - Recommended operational range: within 16.25 ft. (5m)
- The Play/Pause, Next, Prev buttons are not operable in TV SoundConnect mode.

► Using the Bluetooth POWER On function

The Bluetooth POWER On function is available after you have successfully connected the Soundbar to a Bluetooth compatible TV using TV SoundConnect. When the Bluetooth POWER On function is ON, turning the connected TV on or off will turn the Soundbar's power on and off as well.

- Connect the TV to your Soundbar using the TV SoundConnect function.
- Press the **Bluetooth POWER** button on the Soundbar remote. "ON/OFF-BLUETOOTH POWER" appears on the Soundbar's display.
 - ON-BLUETOOTH POWER : The Soundbar turns on and off when you turn the TV on or off.
 - OFF-BLUETOOTH POWER : The Soundbar only turns off when you turn the TV off.





- This function is supported by some Samsung TVs released from 2013 on.

USB

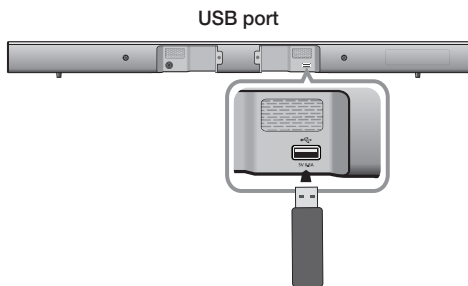
You can play music files located on USB storage devices through the Soundbar.



1. Connect the USB device to the USB port on the back of the product.
2. Press the  button on the main unit's top panel or the  (SOURCE) button on the remote control to select the **USB** mode.
3. **USB** appears on the display screen.
 - The Soundbar connection to the USB device is complete.
 - The Soundbar automatically turns off (Auto Power Off) if no USB device has been connected for more than 25 minutes.

- Do not connect multiple storage devices to the product via a multi-card reader. It may not operate properly.
- Digital camera PTP protocols are not supported.
- Do not remove the USB device while it is transferring files.
- DRM-protected music files (MP3, WMA) from commercial web sites cannot be played.
- External HDDs are not supported.
- Mobile phone devices are not supported.
- File Format Type Compatibility list:

► Before you connect a USB device

Be aware of the following:

- If the file name of a file or folder on a USB device exceeds 10 characters, it is not displayed on the Soundbar's display.
- This product may not be compatible with certain types of USB storage media.
- The Soundbar supports the FAT16 and FAT32 file systems.
 - The NTFS file system is not supported.
- Connect USB devices directly to the USB port of the product. Otherwise, you may encounter a USB compatibility problem.

Format	Codec	Sampling Rate	Bitrate
*.mp3	MPEG 1 Layer2	16KHz ~ 48KHz	80kbps-320kbps
	MPEG 1 Layer3		
	MPEG 2 Layer3		
	MPEG 2.5 Layer3		
*.wma	Wave_Format_MSAudio1	16KHz ~ 48KHz	56kbps-128kbps
	Wave_Format_MSAudio2		
*.aac	AAC	16KHz ~ 96KHz	48kbps-320kbps
	AAC-LC	96KHz	128kbps-192kbps
	HE-AAC	24KHz ~ 96KHz	48kbps-64kbps
*.wav	-	16KHz ~	up to 3000kbps
*.ogg	OGG 1.1.0	48KHz	50kbps-500kbps
*.flac	FLAC 1.1.0,	16KHz ~ 96KHz	up to 3000kbps
	FLAC 1.2.1		

SOFTWARE UPDATE

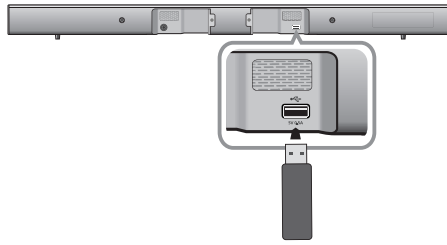

Samsung may offer updates for the Soundbar's system firmware in the future.

If an update is offered, you can update the firmware by connecting a USB device with the firmware update stored on it to the USB port on your Soundbar.

Note that if there are multiple update files, you must load them onto the USB device singly and use them to update the firmware one file at a time.

Please visit samsung.com or contact the Samsung call center to receive more information about downloading updates files.



- The product has a DUAL BOOT function. If the firmware fails to update, you can update the firmware again.



- Insert a USB device containing the firmware update into the USB port on the main unit.
- Updating firmware may not work properly if audio files supported by the Soundbar are stored in the USB storage device.
- Do not disconnect the power or remove the USB device while updates are being applied. The main unit will turn off automatically after completing the firmware update.

- After the update, all settings are reset to their factory default settings. We recommend you write down your settings so that you can easily reset them after the update.

Note that updating firmware resets subwoofer connection too. If connection to the subwoofer is not established automatically after resetting, refer to page 14.

If the firmware fails to update, we recommend formatting the USB device in FAT16 and trying again.

- Once the software update is complete, turn off the product and then press and hold the (▶||) button on the remote control for more than 5 seconds. "INIT" appears on the display and the unit is powered off. The upgrade is complete.
- Do not format the USB device in the NTFS format. The Soundbar does not support the NTFS file system.
- Depending on the manufacturer, some USB devices may not be supported.

TROUBLESHOOTING

Refer to the table below when this product does not function properly.

The unit will not turn on.	
• Is the power cord plugged into the outlet?	→ Connect the power plug to the outlet.
A function does not work when the button is pressed.	
• Is there static electricity in the air?	→ Disconnect the power plug and connect it again.
Sound is not produced.	
• Is the Mute function on?	→ Press the Mute button to cancel the Mute function.
• Is the volume set to minimum?	→ Adjust the Volume.
The remote control does not work.	
• Are the batteries drained?	→ Replace with new batteries.
• Is the distance between the remote control and main unit too far?	→ Move closer to the unit.
The TV SoundConnect (TV pairing) failed.	
• Does your TV support TV SoundConnect?	→ TV SoundConnect is supported by some Samsung TVs released from 2012 on. Check your TV to see if it supports TV SoundConnect.
• Is your TV firmware the latest version?	→ Update your TV with the latest firmware.
• Does an error occur when connecting?	→ Contact the Samsung Call Center.
• Reset the TV MODE and connect again.	→ Press and hold the ► button for 5 seconds to reset the TV SoundConnect connection.
The red LED on the subwoofer blinks and the subwoofer is not producing sound.	
• Your subwoofer may not be connected to the main body of the product.	→ Try to connect your subwoofer again. (See Page 14)
The subwoofer drones and vibrates noticeably.	
• Try to adjust the vibration of your subwoofer.	→ Press the WOOFER button on your remote control to adjust the subwoofer volume (between SW-12 and SW+6. See page 9.).

APPENDIX

SPECIFICATIONS

Model name	HW-J550/HW-J551		
GENERAL	USB		5V/0.5A
	Weight	Main Unit	3.7 lbs
		Subwoofer	15.0 lbs
	Dimensions (W x H x D)	Main Unit	37.1 x 2.2 x 2.6 inches
		Subwoofer	17.8 x 13.2 x 6.1 inches
	Operating Temperature Range		+41°F to +95°F
	Operating Humidity Range		10 % to 75 %
AMPLIFIER	Rated Output Power	Main Unit	80W/CH, 3 OHM, THD = 10%, 1kHz
		Subwoofer	160W, 3 OHM, THD = 10%, 100Hz
	S/N Ratio (Analog Input)		65 dB
	Separation (1kHz)		65 dB

* S/N ratio, distortion, separation, and usable sensitivity are based on measurements using AES (Audio Engineering Society) guidelines.

* Nominal specification

- Samsung Electronics Co., Ltd reserves the right to change the specifications without notice.
- Weight and dimensions are approximate.
- Dispose unwanted electronics through an approved recycler.

Open Source License Notice

- For further information on Open Sources used in this product, please visit the website:<http://opensource.samsung.com>
- To send inquiries and requests regarding open sources, contact Samsung via Email (oss.request@samsung.com).



SAMSUNG

LIMITED WARRANTY TO ORIGINAL PURCHASER

Samsung Electronics Canada Inc.(SECA), warrants that this product is free from defective material and workmanship.

SECA further warrants that if this product falls to operate properly within the specified warranty period and the failure is due to improper workmanship or defective materials, SECA will repair or replace the product at its option.

All warranty repairs must be performed by a SECA Authorized Service Center. (The name and address of the location nearest you can be obtained by calling toll free: 1- 800- SAMSUNG)

LABOR

One year (Carry- in)

PARTS

One year

On carry-in models, transportation to and from the service center is the customer's responsibility.

The original dated sales receipt must be retained by the customer and is the only acceptable proof of purchase. It must be presented to the authorized service center at the time service is requested.

EXCLUSIONS (WHAT IS NOT COVERED)

This warranty does not cover damage due to accident, fire, flood and/ or other acts of God; misuse, incorrect line voltage, improper installation, improper or unauthorized repairs, commercial use or damage that occurs in shipping. Exterior and interior finish, lamps, glass are not covered under this warranty. Customer adjustments which are explained in the instruction manual are not covered under the terms of this warranty. This warranty will automatically be voided for any unit found with a missing or altered serial number. This warranty is valid only on products purchased and used in Canada.

Samsung Electronics Canada Inc
2050 Derry Rd West
Mississauga, On. L5N 0B9
Tel: 1-800-SAMSUNG (726-7864)
Fax: (905) 542- 1199
Website: www.samsung.com/ca



Contact SAMSUNG WORLD WIDE

If you have any questions or comments relating to Samsung products, please contact the SAMSUNG customer care center.

Country	Contact Center ☎	Web Site
CANADA	1-800-SAMSUNG (726-7864)	www.samsung.com/ca/support (English) www.samsung.com/ca_fr/support (French)
U.S.A	1-800-SAMSUNG (726-7864)	www.samsung.com/us/support
MEXICO	01-800-SAMSUNG (726-7864)	www.samsung.com/mx/support