

14mm F2.8 ED AS IF UMC Instruction Manual

Thank you for purchasing our 14 mm F2.8 ED AS IF UMC lens. We believe that this new 14 mm F2.8 ED AS IF UMC lens will give you a special photographic experience.

This new lens is designed and manufactured using our patented complex aspherical lens manufacturing technology, coupled with state-of-the-art optical technology. We have succeeded in reducing aberrations and managing the optical performance of our lens using this technology.

Advantages of the 14 mm F2.8 ED AS IF UMC lens:

1. Corrects aberrations using a complex aspherical and glass aspherical lens and, in the fully opened position, produces high resolution and high contrast at the center of the lens as well as around its periphery.
2. Controls chromatic aberration perfectly by using premium optical glass with high refraction and extra-low dispersion.
3. Allows precision focus control by providing a soft and wide focus operation area.
4. Ultra multi coating design for optimum suppression of ghost images and vivid color image reproduction.
5. Maintains an unchanged size with its inner focus design.

The 14 mm F2.8 ED AS IF UMC lens is designed with its own mount. You can easily take photographs without installing an additional adaptor, mounting the lens directly onto the camera.

Read this instruction manual carefully and use it properly.
* Please read the safety precautions at the back of this instruction manual prior to use.

● Read this instruction manual prior to use ●

2. Attaching and Detaching from the Camera

The 14mm F2.8 ED AS IF UMC lens is designed for Nikon(Fujifilm), Pentax(Samsung GX), Sony(Minolta), Canon and 4/3 compatible cameras.

[Attaching]

Hold the hood of the lens gently, align the depth of field scale of the lens with the lens attachment reference point on the camera, push the lens into the camera and turn the lens gently until it makes a clicking sound and the depth of field scale is positioned at the upper part of the camera.

[Detaching]

Hold the hood of the lens gently, press the lens release button on the camera, turn the lens until the depth of field scale of the lens is aligned with the lens attachment reference point on the camera, and then pull the lens out.

3. Focus Adjustment

You can set the focus for a subject by turning the focus adjustment ring when using the 14 mm F2.8 ED AS IF UMC lens, as it is a Manual Focus (MF) adjustment lens.

[Nikon (Fujifilm) / Pentax (Samsung GX) Mount]

① To change the focus from a subject that is far away to a subject that is close, turn the focusing ring to the right (from ∞ to 1) and focus on the clearest subject using the indication signal on the camera or by checking visually.

② To change the focus from a subject that is close to a subject that is far away, turn the focusing ring to the left (from 1 to ∞) and focus on the clearest subject using the indication signal on the camera or by checking visually.

[Sony (Minolta) / Canon / Four-Thirds Mount]

① To change the focus from a subject that is far away to a subject that is close, turn the focusing ring to the right (from ∞ to 1) and focus on the clearest subject using the indication signal on the camera or by checking visually.

② To change the focus from a subject that is close to a subject that is far away, turn the focusing ring to the left (from 1 to ∞) and focus on the clearest subject using the indication signal on the camera or by checking visually.

4. Brightness Control

You can set the brightness you want by turning the aperture adjustment ring when using the 14 mm F2.8 ED AS IF UMC lens.

[Aperture adjustment ring markings]

① Nikon (Fujifilm) / Sony (Minolta) / Canon / Four-Thirds

22 16 11 8 5.6 4 2.8 2 1.4

② Pentax (Samsung GX)

A • 22 16 11 8 5.6 4 2.8 2 1.4

Each number is 1 stop (1 EV) away from the next number. Brightness can be set more precisely by using the stop setting in between. (However, the Sony (Minolta) mount is only controlled in steps of 1 stop

Example)

1.4 and 2 are 1 stop (1 EV) away from each other.

22 16 11 8 5.6 4 2.8 2 1.4

Set a brightness between 1.4 and 2, which is 0.5 stop away (0.5 EV) from both of them.

22 16 11 8 5.6 4 2.8 2 1.4

5. Camera Settings

Some cameras require special settings when using this lens. Please refer to the following and set the camera when necessary.

○ Nikon (Fujifilm)

1. Set the camera mode dial to 'M'.

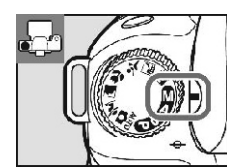

2. Set the focus adjustment lever of the camera to 'M'.



3. When an MF lens is attached, some Nikon cameras allow you to enter the focal length and the brightness. With these Nikon cameras, you can use the MF lens more efficiently by entering the focal length and the brightness.

* For some Nikon cameras, if you enter the focal length and the brightness, and set the desired brightness by turning the aperture adjustment ring, the camera automatically changes the shutter speed. Therefore you don't have to adjust the shutter speed as well, which is required in M mode.

(The camera settings are different depending on each model and are subject to change due to functional enhancements. Therefore, for detailed information on your camera settings, please refer to your camera manual or contact your camera manufacturer.)

○ Pentax (Samsung GX)

1. Av mode

The 14 mm F2.8 ED AS IF UMC Pentax / Samsung GX mounts support Av mode.

1) Align the A mode indicator to the depth of field scale by pressing the A button on the aperture adjustment ring of the lens.

2) Set the mode dial of the camera to 'Av'.

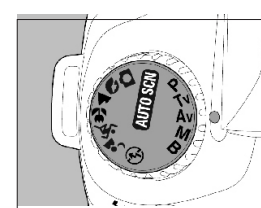

3) Set the focus adjustment lever of the camera to 'MF'.

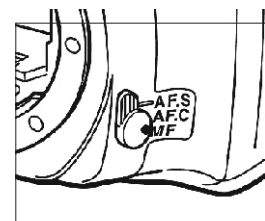

4) Set the menu on the camera.

The user sets the menu. → The aperture ring is used. → Not allowed.

5) Adjust the brightness by turning the dial at the back of the camera.

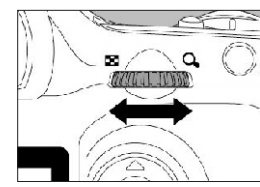

(The procedure and description above are given based on the K200. The camera settings are different depending on each model and are subject to change due to functional enhancements. Therefore, for detailed information on your camera settings, please refer to your camera manual or contact your camera manufacturer.)

1. Component Names

[Figure]

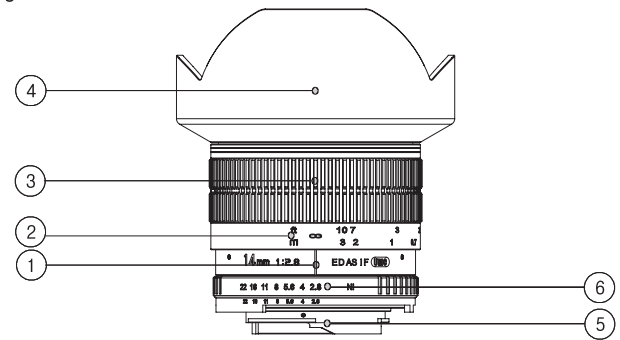

① Depth of field scale ② Focus scaling ring ③ Focusing ring

④ Hood locking area ⑤ Mount ⑥ Aperture adjustment ring

- AS: Aspherical lens (GAS: Glass Aspherical, HAS: Hybrid Aspherical)
- IF: Inner Focus
- UMC: Ultra Multi Coating
- ED: Extra-low Dispersion lens
- HR: High Refraction lens

○ Four-Thirds

The aperture of the 14 mm F2.8 ED AS IF UMC Four-Thirds mount is not geared to the camera.

If the brightness (F-number) is set to 8 or larger, you may not be able to focus the subject properly because it is difficult to see the subject through your camera viewfinder. Therefore, when this lens is attached to your camera, turn the aperture adjustment ring to fully open the aperture and check that the focus is correct; then readjust the aperture to set the depth of field and brightness you want. Then take your photograph.

1) Set the camera mode dial to 'M'.

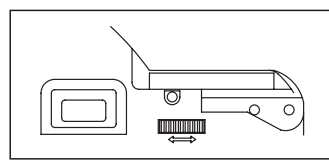
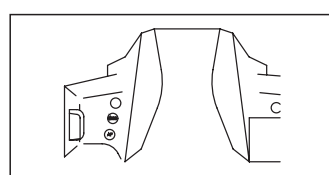

2) Hold down the AF button and turn the dial until it is set to 'MF'.

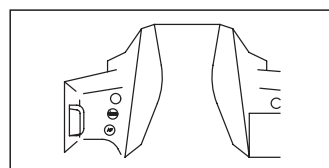

○ Samsung NX

The aperture of the 14 mm F2.8 ED AS IF UMC Samsung NX mount is not geared to the camera.

If the brightness (F-number) is set to 8 or larger, you may not be able to focus the subject properly because it is difficult to see the subject through your camera viewfinder. Therefore, when this lens is attached to your camera, turn the aperture adjustment ring to fully open the aperture and check that the focus is correct; then readjust the aperture to set the depth of field and brightness you want. Then take your photograph.

1) Set the camera mode dial to 'M'.

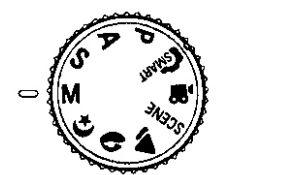

2) Adjust the shutter speed to achieve the appropriate exposure for the brightness.



* For some Samsung NX cameras, if you set the camera mode dial to 'Av' and set the brightness by turning the aperture adjustment ring on the lens, the camera automatically changes the shutter speed. Therefore you don't have to adjust the shutter speed as well, which is required in M mode.

(The procedure and description above are given based on the NX10. The camera settings are different depending on each model and are subject to change due to functional enhancements. Therefore, for detailed information on your camera settings, please refer to your camera manual or contact your camera manufacturer.)

7. Troubleshooting

Symptom	Causes	Action
The lens can't be attached to my camera.	The reference point on the lens is not aligned with the lens attachment reference point on the camera.	Align the reference point on the lens with the lens attachment reference point on the camera.
The lens can't be detached from my camera.	Incorrect rotation direction for detaching the lens. If you turn the lens just by holding your camera, it may cause damage to the lens.	Hold down the lens release button on the camera, and gently turn the lens to the lens attachment/detachment reference point marked on the camera, and then pull the lens forward.
Dark image	Incorrect focusing. Insufficient shutter speed or camera shake.	Turn the focusing ring while checking the subject with the indication on the camera or checking visually to set the focus and the subject is clear, and then press the shutter. Steady the camera and take a photograph at a shutter speed of 1/125 sec.
Autofocus failure	Autofocus failed with a manual control focus lens.	Set the focus by turning the focusing ring.
Pictures too dark or too bright	As this lens is equipped for APS-C size images, so the periphery gets dark when using a digital camera for 1:1 size images.	Set an appropriate exposure and then take the photograph.
The camera flash is not geared to the camera.	This lens corresponds to the Nikon AF-P lens.	Refer to your camera manual or your flash manual. This lens is not a "D-type" lens (which relays distance information to the camera).
The camera finder indication or there is no display.	This lens doesn't have an electric contact signal so there is no communication with the camera through electric signals.	This does not indicate that there is a problem with shooting.
Zoom failure	This lens is a single lens.	
The lens can't be attached to other cameras.	This lens is designed for Nikon's own mount.	Use this lens with a Nikon DSLR camera.
I want to attach your 2X or 1.4X converter lens.	Our converter is designed for the T (M42 screw) mount only. Therefore, it cannot be used with the 14 mm F2.8 ED AS IF UMC lens.	Use a converter produced and sold by Nikon. But autofocus is not available.

○ Konica Minolta (Minolta) DYNA Series

If this lens is used on some Konica Minolta (Minolta) DYNA series cameras, the release lock function (misuse prevention function) of the camera must be disabled.

It is required to disable the release lock function only on the first use as below. Procedure for disabling the release lock function

1. Set the main switch of the camera to OFF.

2. Detach the lens from the camera body and set the main switch of the camera to ON by pressing the two following buttons.

- | | |
|--|---|
| 9x1. function button + AE lock button | 303x. Av button + self mode button |
| 7x1. function button + AE lock button | 303x SUPER. drive button + spot button |
| 5x1. function button + spot button | 101x. self-timer button + flash button |
| 3x1. Modification is required as a service center. | 303x. self-timer continuous shooting button + scene select button |
| 807x. ALL button + <locking scene select button | α-Sweet. S. self-timer continuous shooting button + spot button |
| 707x. card button + spot button | α-Sweet. S. (Set the function dial to the multiple exposure). |
| 507x. area replacement button + SD lock button | W. button + self-timer button |
| DNAX2... shooting scene selection button + button | DYNAX2... self-timer button + Turn the left dial on the camera body to off. |

α-Sweet II... Set the camera to custom function 14 and change selection number 1 to 2 (N.A.).

α-7... Set the camera to custom function 16 and change selection number 1 to 2 (N.A.).

α-Sweet Digital... Perform the following operations.

MENU → F2 → release lock without a lens → to the right → N.A → *execute → MENU

α-7 Digital... Perform the following operations.

MENU → F3 → release lock without a lens → to the right → N.A → *execute → MENU

* If the release lock function is disabled by performing the procedure above, the disabled state is maintained even when the main switch is set to OFF. If you want to enable the release lock function, perform the procedure above again.

(The camera settings are different depending on each model and are subject to change due to functional enhancements. Therefore, for detailed information on your camera settings, please refer to your camera manual or contact your camera manufacturer.)

○ Canon

The aperture of the 14 mm F2.8 ED AS IF UMC Canon mount is not geared to the camera.

If the brightness (F-number) is set to 8 or larger, you may not be able to focus the subject properly because it is difficult to see the subject through your camera viewfinder. Therefore, when this lens is attached to your camera, turn the aperture adjustment ring to fully open the aperture and check that the focus is correct; then readjust the aperture to set the depth of field and brightness you want. Then take your photograph.

1) Set the camera mode dial to 'M'.

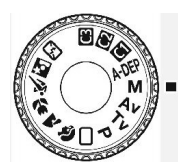

2) Adjust the shutter speed to achieve the appropriate exposure for the brightness.



* For some Canon cameras, if you set the camera mode dial to 'Av' and set the brightness by turning the aperture adjustment ring on the lens, the camera automatically changes the shutter speed. Therefore you don't have to adjust the shutter speed as well, which is required in M mode.

(The procedure and description above are given based on the 40D. The camera settings are different depending on each model and are subject to change due to functional enhancements. Therefore, for detailed information on your camera settings, please refer to your camera manual or contact your camera manufacturer.)

6. Specifications

Focal length	14 mm
Max. aperture	F2.8
Negative size	24 X 36 mm
Angular field	35 mm (1:1x) 115.7° (diagonal) APS-C (1:1.5x) 93.9° (diagonal) APS-C (1:1.6x) 89.9° (diagonal) Four-Thirds (1:2x) 76.2° (diagonal)
Focusing range	∞ to 0.28 m (0.9 ft)
Filter connection	none
Number of elements	14 elements
Number of groups	10 groups
Size (without hood)	Nikon 93.6 mm X ∅87.0 mm Pentax 94.6 mm X ∅87.0 mm Sony 95.6 mm X ∅87.0 mm Canon 96.1 mm X ∅87.0 mm Four-Thirds 101.4 mm X ∅87.0 mm Samsung NX 114.6 mm X ∅87.0 mm
Weight (without hood)	Nikon 530g Pentax 530g Sony 534g Canon 552g Four-Thirds 560g Samsung NX 618g

8. Instructions Prior To Use

The following precautions are divided into two types according to the level of danger.

WARNING	CAUTION	The following pictograms are used in the below precautions:
<p>If the instruction is not followed, it may cause death or severe injury to the user.</p>	<p>If the instruction is not followed, it may cause death or severe injury to the user.</p>	<p>Read the instructions carefully and follow them. (Shows a person reading a manual.)</p> <p>Read the instructions carefully and follow them. (Shows a person reading a manual.)</p> <p>Read the instructions carefully and follow them. (Shows a person reading a manual.)</p>
<p>Don't look at the sun through the lens, or it may cause blindness.</p>	<p>Don't touch the lens to the sun or other bright light. If you do, it may cause damage to the lens or the camera mount.</p>	<p>Don't touch the lens to the sun or other bright light. If you do, it may cause damage to the lens or the camera mount.</p>
<p>Don't leave the lens within reach of babies, as they may play with the lens. If the lens falls, it may be damaged.</p>	<p>Don't attempt to modify or alter the lens. If you do, it may cause damage to the lens or the camera mount.</p>	<p>Don't touch the lens to the sun or other bright light. If you do, it may cause damage to the lens or the camera mount.</p>
<p>Don't leave the lens within reach of babies, as they may play with the lens. If the lens falls, it may be damaged.</p>	<p>Don't touch the lens to the sun or other bright light. If you do, it may cause damage to the lens or the camera mount.</p>	<p>Don't touch the lens to the sun or other bright light. If you do, it may cause damage to the lens or the camera mount.</p>

WARNING!
Don't wet this product or expose it to a moist environment. It may cause a fire or electric shock.

CAUTION!

- Don't use this product or store it close to devices that generate heat i.e., heaters, thermal regulators, stoves, stereo amplifiers.
- Don't leave the lens in conditions where drastic temperature changes can occur.
- Don't touch the surface of the lens by hand, and avoid making contact with sharp objects.
- Avoid dropping the lens.
- Don't soak the lens in water, and avoid water splashing onto the lens.
- If there are foreign bodies on the lens, use a lens cleaning kit only.
- If you cut the hood, it may cause damage to the surface of the lens, as the surface of the lens may make contact with the floor.