

e835

e835 S

Bedienungsanleitung
Instructions for use
Notice d'emploi
Istruzioni per l'uso
Instrucciones para el uso
Gebruiksaanwijzing



evolution

Deutsch

English

Français

Italian

Español

Nederlands

☉835 / ☉835 S

The ☉835 is a cardioid lead vocal stage microphone specially designed to perform under pressure.

Its balanced frequency response maintains signal quality when moving on and off axis during performance. The gentle presence boost ensures vocal clarity and projection. The minimal proximity effect provides for consistently clear bass-end performance when singing closer to, or further from the microphone.

The cardioid pick-up pattern provides excellent feedback rejection, enabling the microphone to handle higher sound pressure levels. The rugged metal construction and internal damping isolates handling noise.

The ☉835 S variant features a silent ON/OFF switch.

Features

- Rugged metal body
- Excellent feedback rejection
- Shock-mounted capsule provides excellent suppression of handling noise
- Uniform on- and off-axis response
- Cardioid pick-up pattern provides isolation from other on-stage signals
- Humbucking coil

Delivery includes

- 835 / 835 S microphone
- MZQ 800 microphone clamp
- Pouch
- Instructions for use
- Warranty Certificate

ON/OFF switch (835 S only)

Use the screw to lock the switch in the ON position. With the switch set in the ON position, gently turn the screw head 90° to lock the switch in position.

Pin assignment of XLR-3 connector

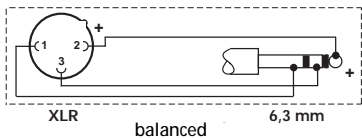
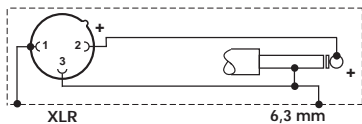
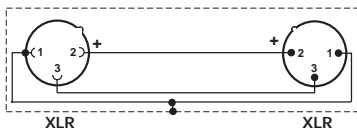
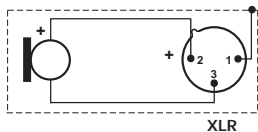

Removing the sound inlet basket

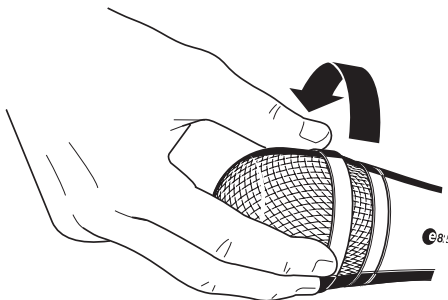

Positioning the microphone

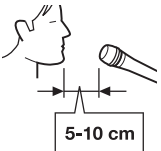
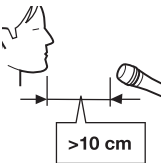
Position	Resulting sound	Commentary
	High proximity effect (much bass/ fundamental) Powerful, direct sound	Very little crosstalk from other sound sources
 5-10 cm	Less proximity effect (less bass/ fundamental) Some room ambience, natural, balanced sound	More crosstalk from other sound sources
 >10 cm	Very little proximity effect (little bass/ fundamental) More room ambience, indirect sound	Much crosstalk from other sound sources

If sibilance or “popping” occurs, position the microphone not directly in front of the mouth but slightly to the side. In order to prevent feedback, position monitor loudspeakers so that they are located in the angle area of the highest cancellation of the microphone.

In order to prevent interference due to crosstalk between adjacent sound sources, try to position the microphone so that the interfering sound source is located in the angle area of the highest cancellation of the microphone (approx. 180° ; see polar diagram).

Polar diagram

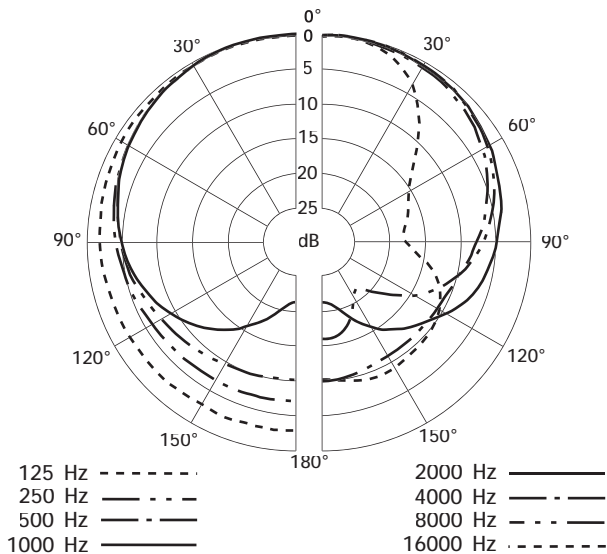

Frequency response curve

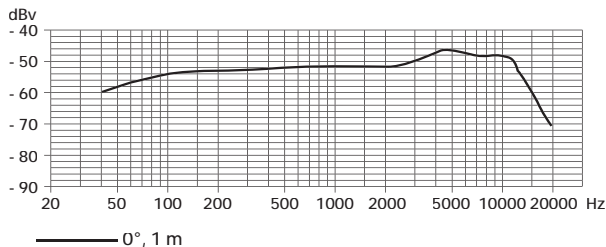

Specifications

Transducer principle	dynamic
Frequency response	40.....16,000 Hz
Pick-up pattern	cardioid
Sensitivity (free field, no load at 1 kHz)	2.7 mV/Pa
Nominal impedance	350 Ω
Min. terminating impedance	1 k Ω
Connector	XLR-3
Weight	330 g
Dimensions	Ø 48 x L 180 mm

Overview of microphone applications

Application	Variant										
	e602	e604	e606	e608	e614	e815	e825	e835	e840	e845	e865
Vocals						x	x	x	x	x	x
Choirs					x						
Studio, acoustic instruments					x						
Orchestra					x						
Brass / Saxophone	x	x		x							
Acoustic guitar					x						
Acoustic bass					x						
Guitar amplifiers			x								
Bass amplifiers	x										
Leslie	x	x	x								
Piano, grand piano					x						
Kick drums	x										
Snare drums		x	x	x							
Rack toms		x	x	x							
Floor toms	x	x	x								
Congas		x	x	x							
Cymbals					x						
Percussion		x	x	x	x						
Overheads					x						

Manufacturer declarations

Warranty

2 years

Approval



Sennheiser electronic GmbH & Co. KG declare that this device is in compliance with the applicable CE standards and regulations.

WEEE Declaration



Please dispose of this product at the end of its operational lifetime by bringing it to your local collection point or recycling centre for such equipment.





Sennheiser electronic GmbH & Co. KG
30900 Wedemark, Germany
Phone +49 (5130) 600 0
Fax +49 (5130) 600 300
www.sennheiser.com

Printed in Germany

Publ. 01/06

511655/A03